

Volume I

PIPELINE SAFETY AND ENHANCEMENT PLAN (PSEP)
2018 REASONABLENESS REVIEW – A.18-11-010
AMENDED WORKPAPERS
TABLE OF CONTENTS

Workpaper Page No.	Workpaper Chapter Title
WP-Intro-1 - 16	Introduction to Workpapers Supporting the Testimony of Rick Phillips: Chapter II, Chapter III, and Hugo Mejia: Chapter IV
WP-SCS-1 - 19	Appendix A - Standard Construction Summary for Replacement, Hydrotest and PSEP Valve Projects
WP-G-1 - 13	Appendix B - Glossary
WP-III-A1 - A1037	Pipeline Pressure Test/Replacement Projects
WP-IV-A1 - A914	Valve Enhancement Projects
WP-VII-A1 - A6	Company Overheads
WP-IX-A1 - A8	Revenue Requirements

WP-Intro-1 - 16

**Introduction to Workpapers Supporting the Testimony
of Rick Phillips: Chapter II, Chapter III
and Hugo Mejia: Chapter IV**

SoCalGas and SDG&E 2018 Reasonableness Review

Workpapers supporting the testimony of Rick Phillips, (Chapter III),
and Hugo Mejia, (Chapter IV)

INTRODUCTION

The workpapers that follow consist of final reports that describe the actions taken in each of the 83 SoCalGas and SDG&E projects included in the 2018 Reasonableness Review to achieve the following objectives:

- 1) Enhance public safety;
- 2) Comply with the directives of the Commission as set forth in Decision (D.)11-06-017;
- 3) Minimize customer and community impacts; and/
- 4) Maximize the cost effectiveness of safety enhancement investments for the benefit of our customers.

Each report describes the activities and decision-making undertaken in each functional area (Scoping, Engineering, Design and Planning, and Construction) to address the unique aspects of each project, and details the final project costs that result from those activities and decision-making. These projects were primarily placed in operation (NOP-ed) prior to June 30, 2017 and the costs were reconciled as of April 30, 2018. Trailing costs or adjustments posted after April 30, 2018 are not reflected in the totals shown.

As explained in Witness Phillips' Chapter 3 testimony, the Stage Gate Review Process sequences and schedules PSEP project workflow deliverables. Key design, management and execution actions and activities occur within and across the various stages. The Stage Gate Review Process for all but two of the pipeline projects presented for review in this Application consisted of seven stages with specific objectives for each stage, and an evaluation gate at the end of each stage to verify that those objectives have been met before proceeding to the next stage.¹ As described in Witness Mejia's Chapter 4 testimony, for valve enhancement projects, activities that occur in Stages 1 and 2 are combined and presented jointly at a stage gate meeting. Stage 3 is presented at a separate stage gate meeting. At the end of Stage 4, there is a final stage gate to obtain authorization to proceed to construction².

¹ Two projects presented in this Application, Line 41-17 and Line 41-116, were executed by the Operating District and did not follow the same seven stage workflow process implemented within the PSEP Organization.

² Chapter IV (Mejia) at 3

The descriptions below, divided into two sections, Pipeline Projects and Valve Enhancement Projects, defines the purpose of each section of the final project reports. In addition, it includes discussion of activities that are common to all projects.

Included at the end of this introductory section is **Appendix A**, Standard Construction Summary for Replacement, Hydrotest, and PSEP Valve Projects and **Appendix B**, Glossary (that will assist in defining specific terminology used throughout the workpapers).

PIPELINE PROJECTS

This Pipeline Projects section of this Introduction walks through the components of the workpapers for the pressure test, replacement and abandonment pipeline projects presented for review in this Application and listed in Table 1 below.

Table 1 – Pipeline Hydrotest and Replacement Projects for 2018 Reasonableness Review

Pipeline Workpaper Title	Project Scope (miles, rounded)			Utility
	Hydrotest	Replace	Abandon	
30-18 Section 1 and 3 Replacement Project		2.008	0.003	SoCalGas
33-120 Section 3 Replacement Project		0.516		SoCalGas
36-1002 Replacement Project		0.034		SoCalGas
36-9-09 North Section 1 Replacement Project		5.975		SoCalGas
36-9-09 North Section 3 Replacement Project		2.956		SoCalGas
36-9-09 North Section 4A and 4B Replacement Project		1.034		SoCalGas
36-9-09 North Section 7A and 7B Replacement Project		4.260		SoCalGas
37-07 Replacement Project		3.222		SoCalGas
37-18 Sections 1,2,3,4 and 5 Replacement Project		4.291		SoCalGas
38-200 Replacement Project		0.369		SoCalGas
38-501 Replacement Project		2.410	0.013	SoCalGas
38-504 Replacement Project		0.377		SoCalGas
38-512 Replacement Project		4.901	0.059	SoCalGas
38-514 Replacement Project		2.930		SoCalGas
38-931 Replacement Project		0.997	0.018	SoCalGas
41-17 Replacement Project			1.790	SoCalGas
41-116 Replacement Project		0.009		SoCalGas
41-6000-2 Replacement Project		11.706	0.035	SoCalGas
43-121 North Section 1 Replacement Project		1.009		SoCalGas
43-121 South Replacement Project		1.475	0.002	SoCalGas
44-137 Replacement Project		1.031	0.008	SoCalGas
44-687 Replacement Project		0.303		SoCalGas
44-720 Replacement Project		1.482	0.011	SoCalGas
49-15 Replacement Project		2.779	0.011	SDG&E
49-28 Replacement Project		2.600		SDG&E
85 South Newhall Avenue Replacement Project		0.085	0.089	SoCalGas
2000-West Santa Fe Springs Replacement Project		0.150	0.050	SoCalGas
31-09 Hydrotest Project	0.188	0.014	0.011	SoCalGas
32-21 Section 1 Hydrotest Project	1.479	0.082		SoCalGas
32-21 Section 2 Hydrotest Project	1.560	0.035	0.007	SoCalGas
32-21 Section 3 Hydrotest Project	2.381	0.010		SoCalGas
37-18-F Hydrotest Project	2.044	0.021	0.019	SoCalGas
49-11 Hydrotest Project	0.878	0.082		SDG&E
406 Section 3 Hydrotest Project	0.426	0.007		SoCalGas
2000-C Hydrotest Project	7.498	0.087		SoCalGas
2001 West-B Hydrotest Project	1.789	0.011		SoCalGas

Pipeline Workpaper Title	Project Scope (miles, rounded)			Utility
	Hydrotest	Replace	Abandon	
2003 Section 2 Hydrotest Project	0.085	0.009		SoCalGas
36-9-09 North Section 5A Hydrotest and Replacement Project	0.572	0.914	0.007	SoCalGas
49-13 Replacement and Hydrotest Project	1.936	1.239		SDG&E
404 Sections 1, 2, 2A, 3, 3A, 4&5, 8A and 9 Replacement and Hydrotest Projects	12.000	0.356	0.298	SoCalGas
1004 Hydrotest and Replacement Projects	8.574	0.395	0.063	SoCalGas
36-9-09 JJ Abandonment Project		0.009	0.453	SoCalGas
36-9-09 South Abandonment Project		0.005	1.235	SoCalGas
Kern Wildlife Bundle Abandonment Project			15.225	SoCalGas

I. BACKGROUND AND SUMMARY:

Included in this section of each project Workpaper is *Table 1: General Project Information*, which provides overall project details such as mileage, pipe diameter (confidential), construction start/stop, project costs, etc. The pipe vintage listed reflects the vintage of the Category 4 Criteria mileage³. In addition, maps and satellite images are included to provide a perspective of the project in relation to the community it impacts and demonstrate the reasonable inclusion of accelerated and incidental pipe when remediating the Category 4 Criteria pipe segments.

II. ENGINEERING, DESIGN, AND PLANNING:

A. Project Scope:

Included in this section is *Table 2: Mileage Information*. Project scope is depicted by mileage type, Criteria, Accelerated, Incidental, New, and Total, depicted in both miles and feet. In some instances, an alignment offset, or rerouted pipeline results in “New” mileage that is greater than or less than the original route.

A high-level summary of the progression of the project chronicles the project evolution. The summary starts with the mileage as proposed in the 2011 PSEP filing and then describes scope validation, where existing pipeline documentation is evaluated. Mileage originally included for remediation may be decreased due to scope validation efforts or if a reduction in Maximum Allowable Operating Pressure (MAOP) is determined to be appropriate from a gas operating

³ Category 4 Criteria mileage consists of segments that lack sufficient documentation of a post-construction strength test to at least 1.25 times the MAOP and are located in a Class 3 & 4 location and Class 1 & 2 High Consequence Area (HCA).

system perspective. Engineering and Design factors further influence the design and result in changes in project mileage that ultimately lead to the final project scope.

B. Decision Tree Analysis:

As described in Witness Phillips' Chapter 3 testimony, a Decision Tree Analysis is performed to confirm the original decision-tree analysis of the project and designation as either a pressure test or replacement project in the 2011 PSEP filing.

Typically, for pipeline projects greater than 1,000 feet in length, a Test-versus-Replace Analysis is conducted to compare costs of at least two scenarios (test or replace) and in some cases routine alternatives are also considered. Project execution options are then presented to PSEP leadership at a Stage 2 gate review and approval is given to move forward with more detailed engineering and design efforts for the recommended project type.

C. Engineering, Design, and Planning Factors:

Engineering, Design and Planning activities occur and evolve from Stage 2 through Stage 4 and include analysis of pipeline attribute records, survey and mapping activities, and a site visit. Base mapping, surveying, and locating activities determine or confirm the proposed route by identifying the location and depth of existing substructures along the proposed route of the project, jurisdictions and/or land owners, right-of-way constraints, etc. These data points serve to influence the routing and design of the project, and the project schedule.

Once the preliminary route alignment is determined, the process of acquiring permits and land rights begins. Permits typically involve long lead times, negotiations of conditions, and sometimes last-minute agency requirements that are incorporated into project design that can therefore impact the project schedule. In addition, there are site visits associated with permit applications and job walks with agency inspectors. Inspectors can and do change permit conditions, often impacting the project schedule.

Material procurement is identified in two main phases, long-lead items and short-lead items. Long-lead material is identified and purchased at the 30% design stage while short-lead material is identified and purchased at the 60% design stage. When possible, SoCalGas and SDG&E acquire materials by aggregating anticipated material needs (bulk purchasing) from many projects thereby making periodic purchases for larger quantities of material at a lower unit cost. Once the detailed design is finished and construction documents are completed, necessary

permits and authorizations are attained, pipeline materials are purchased, received, inspected, and prepared for turnover to the construction contractors.

D. Scope Changes:

Throughout the Engineering, Design and Planning process, constructability or scheduling hurdles may be revealed that require mitigation and a partial or complete redesign. Examples of the challenges frequently encountered are permit or land use restrictions, environmental constraints, customer impacts, traffic and other community impacts, system constraints, or pipe conditions identified once the pipe is exposed through potholing efforts. Redesign efforts add to the project cost but ultimately result in a cost-effective solution, given all the unique conditions and constraints of each project. In some instances, a project is sectionalized at this juncture and the sections that can be remediated as soon as practicable are scheduled for construction and the remaining sections are postponed until identified obstacles have been addressed. The final project design considers cost effectiveness, system operating efficiencies, mitigation of customer and community impacts, and system capacity constraints. Scope changes are reviewed and authorized and documented using a scope change form. The incremental costs associated with a subsequent scope change would not be reflected in the estimated costs in Tables 4 and 5.

III. CONSTRUCTION⁴:

A. Construction Contractor Selection:

Construction activity begins with the selection of the Construction Contractor during Stage 4. Thirty-six of the forty-five pipeline projects in the 2018 Reasonableness Review were assigned to the Performance Partner selected for that region. The Performance Partner Program allows for competitive pricing of projects and provides incentives associated with the program to encourage the Construction Contractors to further reduce costs. Occasionally, Performance Partners work outside their assigned regions to maintain a balance of work across all Performance Partners. In some instances, a project or section of a project, was single-sourced to a contractor, typically one who was under contract to do work in the region, was familiar with the pipeline and was already engaged in construction activity in the vicinity, and whose pricing

⁴ Construction Activity is further detailed in Appendix A to these workpapers, which provides a description of the large variety of field activities that may take place on a PSEP pipeline or valve project.

was determined to be competitive based on pricing previously established for other projects through a competitive solicitation process.

Once the Issue-for-Bid design (90% design drawing) is completed, a final scope of work is prepared and provided to the Construction Contractor, which the Construction Contractor uses to prepare a Target Price Estimate (TPE). Each project executed by a Performance Partner requires negotiation of an agreed-upon TPE. The Construction Contractor selection process for each project are described in the project workpapers.

B. Construction Schedule:

Construction field activities begin with the establishment of a field construction office and preparation of the laydown yard and construction area for work, which typically involves extensive trenching and excavating activities where various portions of the pipeline must be exposed prior to construction to confirm the location of pipe features, such as tap locations (feeds off the pipeline that will need to be isolated or provided with an alternative source of supply), and features identified for removal and/or replacement. If traffic control is required, K-rails may be set up to protect the construction area and other mitigation efforts to protect the environment. Construction activities are planned to efficiently execute the construction phase of the project, and include coordination with Gas Operations to coordinate required shut-in and tie-in activities. *Table 3: Construction Timeline* depicts the construction start date, completion date and Notice of Operation (NOP) date for each project. For projects with more than one section, Table 3 reflects the construction start date for the first section and the construction completion and NOP dates for the last section.

C. Changes During Construction:

Most of the pipeline replacement and hydrotest projects presented for review in this Application are located in dense urban environments, which greatly adds to the complexity of the construction activities. Some examples of urban construction challenges are limited space for large equipment to operate or a laydown yard to be established, congested construction areas, substructure conflicts, unknown (undocumented) substructures beneath street surfaces, highly-traveled roadways requiring extensive traffic control and/or reduced working hours, complicated railway or highway work areas, required night work and noise abatement activities, etc. Many of these issues are mitigated and planned for while others are unanticipated and are addressed as they arise in the field, which may require activities that are outside of the original

scope of work upon which the TPE was established. The Construction Contractor describes the unanticipated conditions encountered during construction and the proposed solution to SoCalGas and SDG&E via a Request for Information (RFI) form. If authorized by the PSEP Project Manager, the solution is executed, and any incremental costs are documented via a change order. The workpapers for each project describe notable construction change orders (i.e. when the total construction change order costs are more than 10% of the TPE).

D. Commissioning and Site Restoration:

Restoration of the construction site is typically completed several weeks or even a month or more after the pipeline is returned to service. The site is demobilized, test water is disposed of or stored and removed for use on an adjacent project and the area is returned to its previous condition. This may include repaving and restoration of landscaping.

Stage 7 activities are executed within the final months of the project lifecycle, and include finalization of as-built drawings and uploading of updated information into the company's documentation and recordkeeping systems to reflect the final scope of work.

IV. PROJECT COSTS:

A. Cost Avoidance Actions:

Because PSEP projects are thoughtfully and prudently designed with safety and cost efficiency at top of mind, not all cost avoidance actions are specifically noted. It would be impractical to list all the costlier design options that were briefly considered and rejected. More notable cost avoidance decisions and actions are described in the project workpapers. Some typical areas of cost avoidance and cost savings are derived from planning and design choices that include reduction of project scope, choice of materials or bulk purchasing of materials, project designs that eliminate or reduce features that would complicate routine maintenance activities to reduce future maintenance costs, and planning and coordination of the PSEP project schedule to incorporate other projects to share resources or avoid duplicative or wasted effort. Prudent negotiation of terms with land owners and permit terms, as well as shared land use, are additional means of avoiding costs. Finally, costs are avoided through prudent engineering and design decisions made in the field to address and mitigate unanticipated conditions revealed once the pipe was exposed or otherwise identified during the latter stages of project execution.

B. Cost Estimate:

Estimating activities are initiated in Stage 1, with approval of the Phase 1 Work Order Authorization (WOA) reflecting the estimated costs for preliminary design, mapping and survey activities. Subsequently, based on 30% design drawings, a Total Installed Cost (TIC) estimate is prepared using the most current version of the PSEP Estimating Tool. The TIC is presented to PSEP leadership at the Stage 3 gate review and approval is required to move forward.

The TIC costs reflect direct costs only, which are typically used to prepare the Phase 2 WOA. The Phase 2 WOA includes indirect costs, and therefore, reflects a total loaded project cost estimate. The approval of the Phase 2 WOA is required to proceed with execution of the project. Any significant project activities and costs subsequently added to the project scope after execution of the TIC would not be reflected in the estimated costs presented in Tables 4 and 5. These additional costs and activities are authorized and documented through the scope change process.

C. Actual Direct and Indirect Costs:

The estimated and actual costs shown in *Table 4: Estimated and Actual Direct Costs and Variances* in workpapers are defined as follows:

Company Labor: Labor costs for SoCalGas and SDG&E employees charging directly to the project, such as project managers, engineers, land services personnel, environmental services personnel, construction managers, and field support personnel.

Materials: Costs for materials that SoCalGas and SDG&E purchased to complete the project, such as piping, valves, fittings, and other miscellaneous materials. Materials planned to be purchased by the construction contractor may be included in the construction contractor costs.

Construction Contractor: Costs for construction contractor activity and materials or equipment acquired by the contractor. The actual construction contractor costs also include authorized change order costs and risk reward payments, minus construction credits, when applicable.

Construction Management and Support: Costs for construction inspection, contamination mitigation, environmental monitoring, hydrotesting services, and other miscellaneous activities that occur in the field.

Environmental: Costs for environmental assessments, asbestos abatement, water and waste management, and miscellaneous environmental permits and fees not reflected in other cost categories.

Engineering and Design: Costs for planning and design services, engineering, environmental services, land use and permitting fees not included in other categories, and project support, such as survey, mapping and miscellaneous expenses.

Project Management Services: Contracted costs for project management services and general PSEP program support.

ROW & Permits: Costs associated with permitting fees and land easement or acquisition expenses not reflected in other cost categories.

GMA: Programmatic PSEP costs.

Indirect Costs are listed in *Table 5: Estimated and Actual Indirect Costs, Total Costs, and Variances*. These costs are incremental overheads applied to PSEP projects. Indirect costs are for those activities and services that are associated with direct costs – such as payroll taxes, pension, benefits, and GMA. Also included is interest that SoCalGas and SDG&E earn for funds used during construction for capital projects (AFUDC) and Property Tax for construction work in progress (CWIP) for capital projects.

There are several factors that may cause a variance between actual and estimated costs. Most of the differences are attributable to the fact estimates are based on a preliminary design, reasonable changes in project scope are required to address conditions identified after the preliminary estimate was prepared, and the continuous improvement of the estimating process and PSEP estimating tool over time. Unforeseen and unplanned field conditions also contribute to variances between the preliminary estimate and actual costs.

D. Disallowances:

Of the 44 PSEP pipeline projects presented for review in this Application, eight projects addressed footages of post-1955 pipe that lacked pressure test records, making portions of those projects subject to disallowance. In the project workpapers for those eight projects, the disallowed scope is described, and the calculation of disallowed costs is provided. The disallowed project costs are provided in the final workpapers for completeness, but the disallowed costs were previously recognized by SoCalGas and SDG&E, are not recorded in the PSEP balancing accounts, and are not included in the revenue requirement presented for review in this Application, as described in Chapter 9 testimony.

VALVE ENHANCEMENT PROJECTS

This Valve Enhancement Projects section of this Introduction walks through the components of the workpapers for the valve enhancement projects presented for review in this Application and listed in Table 2 below.

Table 2 – Valve Projects for 2018 Reasonableness Review

Valve Workpaper Title	Project Scope	Utility
Alhambra Station Valve Enhancement Project	2 Valves/1 site	SoCalGas
Aviation and Boardwalk Valve Enhancement Project	2 Valves/1 site	SoCalGas
Banning 5000 Valve Enhancement Project Bundle	2 Valves/2 sites	SoCalGas
El Segundo Valve Enhancement Project	2 Valves/1 site	SoCalGas
Haynes Station Valve Enhancement Project	3 Valves/1 site	SoCalGas
Honor Ranch Valve Enhancement Project Bundle	4 Valves/2 sites	SoCalGas
Indio Valve Enhancement Project Bundle	4 Valves/2 sites	SoCalGas
Lampson Valve Enhancement Project Bundle	4 Valves/2 sites	SoCalGas
Line 1005 Santa Barbara Valve Enhancement Project	1 Valve/1 site	SoCalGas
Line 1014 Brea Valve Enhancement Project Bundle	4 Valves/2 sites	SoCalGas
Line 1018 Dana Point Valve Enhancement Project	1 Valve/1 site	SoCalGas
Line 1020 Valve Enhancement Project	1 Valve/1 site	SoCalGas
Line 1600 Valve Enhancement Project Bundle	16 Valves/17 sites	SDG&E
Line 2000 Beaumont Riverside Valve Enhancement Project Bundle	3 Valves/3 sites	SoCalGas
Line 2001 Riverside Valve Enhancement Project Bundle	3 Valves/2 sites	SoCalGas
Line 2001 West Section 10 & 11 Valve Enhancement Project	1 Valve/1 site	SoCalGas
Line 2003 East Valve Enhancement Project Bundle	5 Valves/3 sites	SoCalGas
Line 2003 West Valve Enhancement Project Bundle	2 Valves/3 sites	SoCalGas
Line 225 Valve Enhancement Project Bundle	2 Valves/3 sites	SoCalGas
Line 235-335 East Valve Enhancement Project Bundle	7 Valves/6 sites	SoCalGas
Line 3010 Valve Enhancement Project Bundle	9 Valves/9 sites	SDG&E
Line 3600 Valve Enhancement Project Bundle	12 Valves/6 sites	SDG&E
Line 4000 Benson and 7th Valve Enhancement Project	1 Valve/1 site	SoCalGas
Line 4000 MP 45.36 Valve Enhancement Project	1 Valve/1 site	SoCalGas
Line 4000 MP 53.00 Valve Enhancement Project	1 Valve/1 site	SoCalGas
Line 4000 MP 80.08 Valve Enhancement Project	1 Valve/1 site	SoCalGas
Line 4002 Fontana Valve Enhancement Project	1 Valve/1 site	SoCalGas
Line 404 Ventura Valve Enhancement Project Bundle	4 Valves/3 sites	SoCalGas
Line 404-406 Ventura Valve Enhancement Bundle	3 Valves/2 sites	SoCalGas
Line 406 Ventura Valve Enhancement Project Bundle	5 Valves/4 sites	SoCalGas
Line 49-28 Valve Enhancement Project	1 Valve/1 site	SDG&E
Line 6916 Valve Enhancement Project Bundle	3 Valves/3 sites	SoCalGas
Line 7000 Valve Enhancement Project Bundle	2 Valves/2 sites	SoCalGas
New Desert Valve Enhancement Project Bundle	7 Valves/2 sites	SoCalGas
Newhall Valve Enhancement Project Bundle	7 Valves/3 sites	SoCalGas
Orange Valve Enhancement Project Bundle	3 Valves/3 sites	SoCalGas
Questar Taps Valve Enhancement Project	6 Valves/1 site	SoCalGas
Rainbow Valve Enhancement Project Bundle	10 Valves/4 sites	SoCalGas
Sepulveda Station Valve Enhancement Project	1 Valve/1 site	SoCalGas

I. BACKGROUND AND SUMMARY:

When practical and anticipated to provide project management and cost efficiencies, SoCalGas and SDG&E bundled multiple valve enhancement project sites for project management and execution. Included in this background and summary section is *Table 1: General Project Information*, which provides overall valve project details by site, such as location, valve types, and valve and site enhancements. In addition, satellite images are included for the entire bundle (when applicable) and for each site to provide a perspective of the project in relation to the community it impacts, and the other project sites.

II. ENGINEERING, DESIGN AND PLANNING:

As described in Witness Mejia's Chapter 4 testimony, the SoCalGas Engineering group guides execution of the Valve Enhancement Plan and designates which valves require remote automation capability to enable optimal system isolation in the event of an emergency.

A. Project Scope:

Included in this section is *Table 2: Final Project Scope*, which details valve number, valve size (confidential), installation type and function. Project scoping activities include review of existing documentation and a detailed system flow analysis to confirm the scope of the project. As appropriate, modifications are made to the plan to update the scope to include or remove, valves as necessary to achieve planned isolation.

B. Site Evaluation and Planning:

Once a PSEP valve project is initiated and preliminary scope identified, a site visit is conducted to inspect the valve, confirm the normal valve position (open or closed), location of the valve (above-grade or below-grade), valve type and identify other field and site conditions that could impact the successful automation of the valve. Upon receipt of these data points, project engineering and design commences. In cases where it is warranted, the PSEP project team recommends modifications to the project scope and selects an alternate valve for automation or recommends that the valve be moved to a location out of a roadway that is safer and less impactful to customers when routine maintenance is being conducted. A schematic drawing is included in this section to depict the existing valves and valves that were enhanced with remote isolation capability to enable system isolation.

Once the detailed design is prepared and construction documents are completed, necessary permits and authorizations are attained, and required valve materials are purchased, received, and prepared for turnover to contractors.

C. Scope Changes:

Throughout the Engineering, Design and Planning process, constructability or scheduling hurdles are sometimes revealed that require design changes, such as the addition or removal of valves from the project scope, a change in which valves were being enhanced, or a change in the type of enhancement. Scope changes are reviewed and authorized and documented using a scope change form. The incremental costs associated with a subsequent scope change would not be reflected in the estimated costs in Tables 4 and 5.

III. CONSTRUCTION:

A. Construction Contractor Selection:

SoCalGas and SDG&E utilize electrical contractors to execute PSEP valve automation work (installation of controls, wiring, communication and electrical work) and require the additional services of a mechanical construction contractor when a valve is relocated or other pipeline work is required. Valve mechanical work is included within the Performance Partner's anticipated activities within each geographic region. When a Performance Partner is not used, the project is competitively bid. Similar to the Performance Partner Program, SoCalGas and SDG&E created an Alliance Contractor Program for PSEP electrical contractors. Unlike the Performance Partner Program, however, the Alliance Partnership does not include a risk reward provision. Three electrical contractors were selected as Alliance Contractors, following receipt of competitive bids from seven qualified electrical contractors through a competitive solicitation process. Alliance Contractors are assigned projects based on workload and geographic considerations.

Once the Issue-for-Bid design (90% design drawing) is completed, a final scope of work is prepared and provided to the Electrical and Mechanical Contractors, which is used by the Electrical and Mechanical Contractors to prepare their construction cost estimates. Each project executed by an Alliance Contractor or Performance Partner requires negotiation of an agreed-upon estimated cost. The Contractor selection process for each project is described in the project workpapers.

B. Construction Schedule:

Valve projects typically require less mobilization efforts than a pipeline project because the scope of work is much more contained and less invasive to the project site. Demobilization is also less effort and so contractors frequently work on and manage multiple adjacent projects at the same time moving from site to site to execute work when materials and other conditions are available. This creates efficiencies and reduces downtime or standby charges as the project team can remain active but extends the duration of the construction. *Table 3: Construction Timeline* lists the Construction Start and Completion Dates and includes the days on site which is a better indicator of the complexity of the project execution. It also lists the Commissioning Date which is the date that point to point contact verification was achieved indicating that the valve was remotely operable.

C. Changes During Construction:

Once the project proceeds to construction, site conditions may have changed or other anticipated factors may be identified. The Construction Contractor describes the unanticipated conditions encountered during construction and the proposed solution to SoCalGas and SDG&E via an RFI form. If authorized by the PSEP Project Manager, the solution is executed, and the incremental costs are documented via a change order. The workpapers for each project describe notable construction change orders (*i.e.*, when the total construction change order costs are more than 10% of the TPE).

D. Commissioning and Site Restoration:

Commissioning activities include site restoration, a site Acceptance Test, which is necessary to obtain agreement from SoCalGas/SDG&E Gas Operations that the valve project is complete before turnover. The site is demobilized, and the area is returned to its previous condition. This may include repaving and restoration of landscaping. Stage 7 activities are executed within the final months of the project lifecycle, and include finalization of as-built drawings and uploading of updated information into the company's documentation and recordkeeping systems to reflect the final scope of work.

IV. PROJECT COSTS:

A. Cost Avoidance Actions:

Because PSEP projects are thoughtfully and prudently designed with safety and cost efficiency at top of mind, not all cost avoidance actions are specifically noted. It would be impractical to list

all the costlier design options that were briefly considered and rejected. More notable cost avoidance decisions and actions are described in the project workpapers. Some typical areas of cost avoidance and cost savings are derived from planning and design choices that include reduction of project scope, choice of materials or bulk purchasing of materials, project designs that eliminate or reduce features that would complicate routine maintenance activities to reduce future maintenance costs, and planning and coordination of the PSEP project schedule to incorporate other projects to share resources or avoid duplicative or wasted effort. Prudent negotiation of terms with land owners and permit terms, as well as shared land use, are additional means of avoiding costs. Finally, costs are avoided through prudent engineering and design decisions made in the field to address and mitigate unanticipated conditions identified during construction.

B. Cost Estimate:

Estimation activity is initiated in Stage 1 with approval of the Phase 1 WOA, which reflects the estimated costs for preliminary design, mapping and survey activities. Subsequently, based on 60% design drawings, a TIC estimate is prepared using the most current version of the PSEP Estimating Tool available. The TIC is presented to PSEP leadership at a Stage 3 gate review and approval is required to move forward. The TIC costs reflect direct costs only, which are typically used to prepare the Phase 2 WOA. The Phase 2 WOA includes indirect costs, and therefore, provides a total loaded project cost estimate. Approval of the Phase 2 WOA is required to proceed with execution of the project. Any significant project activity and costs subsequently added to the project scope after execution of the TIC would not be reflected in the estimated costs presented in Tables 4 and 5 in the project workpapers. These additional costs and activities are authorized and documented through the scope change process discussed above.

C. Actual Direct and Indirect Costs:

The estimated and actual direct cost elements that are shown in *Table 4: Estimated and Actual Direct Costs and Variances* in workpapers are defined as follows:

Company Labor: Labor costs for SoCalGas and SDG&E employees who charge their time directly to the project, such as project managers, engineers, land services personnel, environmental services personnel, construction managers, and field support personnel.

Materials: Costs for materials purchased by SoCalGas and SDG&E to complete the project, such as valves, fittings, and other miscellaneous materials. Materials planned to be purchased by the construction contractor may be included in the construction contractor costs.

Mechanical Construction Contractor: Costs for mechanical construction activities performed by the Mechanical Contractor and materials or equipment acquired by the contractor. The actual Mechanical construction contractor costs also include authorized change order costs and risk reward payments, minus construction credits, when applicable.

Electrical Contractor: Costs for electrical construction activity and materials or equipment acquired by the Electrical Contractor. The actual Electrical construction contractor costs also include authorized change order costs, when applicable.

Construction Management and Support: Costs for construction inspection, contamination mitigation, environmental monitoring, hydrotesting services, and other miscellaneous activities that occur in the field.

Environmental: Costs for environmental assessments, asbestos abatement, water and waste management, and miscellaneous environmental permits and fees not included in other cost categories.

Engineering and Design: Costs for planning and design services, engineering, environmental services, land use and permitting fees, and project support, such as survey, mapping and miscellaneous expenses not included in other cost categories.

Project Management Services: Contracted costs for project management services and general PSEP program support.

ROW & Permits: Costs associated with permitting fees and land easement or acquisition expenses not included in other cost categories.

GMA: Programmatic PSEP costs.

Indirect Costs are listed in *Table 5: Estimated and Actual Indirect Costs, Total Costs, and Variances* in the workpapers. These costs are incremental overheads applied to PSEP projects. Indirect costs are for those activities and services that are associated with direct costs – such as payroll taxes, pension, benefits, and GMA. Also included is interest that SoCalGas and SDG&E earn for funds used during construction for capital projects (AFUDC) and Property Tax for construction work in progress (CWIP) for capital projects.

There are several factors that may cause a variance (delta) between actual and estimated costs. Most of the differences are attributable to the fact estimates are prepared based on a preliminary design, reasonable changes in project scope are required to address conditions identified after the preliminary estimate was prepared, and the continuous improvement of the estimating process and PSEP estimating tool over time. Unforeseen and unplanned field conditions also contribute to variances between the preliminary estimate and actual costs.

WP-SCS-1 - 19

**Appendix A – Standard Construction Summary
For Replacement, Hydrotest and PSEP Valve Projects**

APPENDIX A

Standard Construction Summary for PSEP Replacement, Hydrotest and Valve Enhancement Projects (Construction Primer)

The following information provides an overview of the typical construction activities that occur during SoCalGas and SDG&E PSEP pipeline replacement, hydrotest and valve (retrofit or new installation) projects.

Most pipeline and valve enhancement projects submitted in this application were constructed in highly dense urban areas, which greatly increased the complexity of the construction work performed. These projects generally occurred in heavily-traveled roadways that required extensive traffic control plans (see Figures 1 and 2). These construction locations are typically crowded with other utility substructures, requiring project teams to perform extensive research work to identify the substructures prior to construction, and causing redesign of projects when undocumented substructures are discovered after excavation during construction. (see Figure 3).

Due to the importance of high-pressure transmission lines to system reliability, these projects require extensive schedule coordination with local operations personnel to minimize customer impacts, execute gas handling, and complete stand-by and tie-in operations. In addition, project schedule accommodations must be made for Gas Control to support system reliability. Some of the capacity constraints can be planned for ahead of time and some need to be mitigated in real-time. Such rescheduling can have significant impacts on a project's overall productivity and efficiency.

In addition to the scheduling of local personnel and Gas Control, there is also a tremendous amount of effort that takes place to schedule and coordinate the required equipment (pressure control, Non-Destructive Testing (NDT), tapping equipment, etc.), construction contract crews (pipeline, electrical, mechanical, etc.), inspectors (NDT, environmental, safety etc.) and oversight personnel (PMO support, Contract Administrators, etc.).

There are numerous individuals with required technical knowledge, trade licenses, and certifications that are essential to producing a successful project that meets the objectives of PSEP.

Lastly, it should be noted that there are some projects that may differ in the general activities described below, depending on the unique characteristics of that job. As appropriate, these conditions are described in the individual work papers for each project.

This first section describes the typical activities of a replacement project. The following sections will discuss the differences seen in hydrotest and PSEP valve enhancement projects as compared to replacement projects.

APPENDIX A

Replacement projects

1. Permits – Typically Stage 3 or 4

One of the initial construction activities that significantly affect project decision-making is the securing of permits. Permits are issued by local, state, or federal agencies and address all natural resources — land, air, water, vegetation, and wildlife — as well as the interests of the general public (e.g., noise permits). Some of the most common agencies involved in issuing permits for PSEP projects are local municipalities, Caltrans, Local tribal organizations, U.S. Army Corps of Engineers, Bureau of Land Management, and environmental agencies. PSEP projects are constructed in a variety of locations: congested urban areas, highways/freeways, railroads/light rails, bridges, environmentally and culturally sensitive areas, coastal zone, commercial centers, private land, hillsides, airport zones, etc. and as such, there are usually many permits required for each project. Each construction location presents unique requirements that are necessary for successful and safe construction, and construction crews must comply with any specific requirements imposed by the permitting agency, such as requiring night work (see Figure 4). Permits may take many months to secure and the final permit requirements may not be known until shortly before construction begins.

2. Surveying and Locating – Stage 3 or 4

Surveying and locating activities typically take place during Stages 3-4 and determine the Right-of-Way (ROW) and pipeline location. The ROW is a narrow strip of land (public or private property) that contains the pipeline(s) and is where all onsite construction activities occur. Before any construction activities can begin, survey and locate and mark crews carefully survey and mark out the construction ROW for the existing pipeline and other identified substructure locations.

To identify the exact location of the pipelines and identified substructures prior to the start of construction, SoCalGas and SDG&E typically complete potholing during Stage 4, but there are times when this activity cannot start until Stage 5 (construction). Potholing involves excavating a small hole over the pipeline to validate the location of an existing substructure.

Surveying and locating activities help to determine what will be needed for the temporary construction easements, possible substructure conflicts within the desired replacement location, and other issues that will need to be accounted for in the project design.

APPENDIX A

In Stage 4, the land acquisition team evaluates nearby locations for a laydown yard and field construction office, which will stage the equipment, material, fabrication space, water for hydrotests, work trailer, etc. for several weeks. Ideally, the yard will be at least 50,000 square feet or about the size of a football field (See Figure 5).

Lastly, during Stages 3 and 4, affected customers are identified and communication materials are generated and sent out to notify customers of the upcoming construction activities in the area. This notification takes place early enough in the process so as to allow for customer input and changes to construction, as appropriate.

3. Clearing and Grading Construction and Laydown Yard - beginning Stage 5

Clearing and grading activities for a project typically take place at the beginning of Stage 5 (Construction) in the non-paved locations. Some projects required extensive work due to work being located on hillsides. Clearing is the removal of all brush from the construction work area. Grading is required to provide a relatively level surface to allow safe operation of the heavy equipment. An environmental inspection may be required of the laydown yard and the pipeline construction area before any construction activity takes place.

4. Trenching and Excavating – Stage 5

Trenching and excavating activity takes place in Stage 5 (Construction). The trenching operation in pavement begins with a saw-cutting crew that cuts the pavement for excavation. Once the pavement is removed from the area, trenching activities can begin. The trenching crew typically uses a backhoe to dig the replacement pipe trench. The trench is excavated to a depth that provides sufficient cover over the pipeline after backfilling.

Typically, a trench is about four to six feet wide in stable soils and at least five feet deep (depending on the pipeline's diameter and DOT Class location to actual depth). This depth allows for the required minimum 36 inches of cover.

Many pipelines are located at a depth that requires elaborate shoring systems to be installed for construction. Shoring is necessary when the excavation is more than five feet deep or is in sandy soil conditions (see Figure 6). The shoring can limit the work area due to beams and other structures that obstruct the construction process, which slows down production (see Figure 1). An example where greater pipeline depth may be needed is a railroad crossing or storm drain conflict.

Given the work that needs to take place on the existing pipeline, the excavation may require hand-digging over the gas pipeline, per code, to expose the pipe and other potential utility substructures in the area. The hand-digging process can be labor and time intensive.

APPENDIX A

For example, if the trench that the pipeline must be installed within is running laterally with another utility structure and the distance is under the legal threshold for mechanical excavation, the entire length must be hand-excavated.

There are also many requirements that must be met during the excavation process that are governed by the various permits issued for a project. For example, when excavating in traveled roadways, which was the case for nearly all 31 projects, steel plates will be needed to cover the open trench at the end of each day. The process of moving the plates on the trench and welding them together at the end of each day and then removing them each morning takes additional time that may decrease productivity, depending on the available working hours set by the permitting agency.

Some installations require a bore operation when the pipeline must be routed under a structure and an open trench cannot be dug, for example, to cross a freeway/highway or railroad, or to avoid disrupting traffic across a busy intersection. In such cases an excavation is only required at the start and end of the bore route; however, these bore pits are typically 30 feet by 15 feet and at a minimum depth of 20 feet (often times greater). This activity requires extensive bell-hole preparation and is a complicated process that necessitates a specialized crew and equipment (see Figures 7 and 8).

Often, each replaced pipeline has taps that feed an individual customer or a regulator station that needs to be connected to the new pipeline once put into service. Each tap location requires an excavation, which is on average approximately five-feet by eight-feet and takes a crew approximately one day per hole to excavate, depending on the soil conditions (shoring may also be needed). Those excavations will be plated and left open until the new pipeline section is tested and gassed up. Then these tap connections can be completed and backfilled.

Lastly, there are some municipalities that require the existing pipeline to be removed and the new pipeline to be installed in the same location. This also might be necessary if the pipeline ROW is not large enough for the replacement pipeline. This removal step can greatly add to the complexity and time for the project.

5. Pipeline Laying, Bending, Welding - Stage 5

The pipe sections, fittings and other pipeline components are laid out on the job site for installation as construction proceeds. In order to follow the design route, the pipe's direction is adjusted through the installation of bends or segmented ells (see Figure 9). In some cases, the joints are welded together and placed on temporary supports (see Figure 10). The pipe crew and a welding crew are responsible for the welding process. The pipe crew typically uses special pipeline equipment called side booms to pick up each joint of pipe, align it with another joint, and make the first part of the weld (a pass called the stringer bead).

APPENDIX A

Additional filler passes are made by welders who immediately follow the stringer bead. There could be different welders for the different welds needed: stringer, hot-pass, and capping welders make up the typical welding crew, and they are often followed by tie-in welders.

6. Non-Destructive Examination (NDE) - Stage 5

As part of the quality assurance process, each welder must pass qualification tests (Operator Qualification) to work on a particular pipeline job, and each weld procedure must be approved for use on that job in accordance with federally-adopted welding standards.

The welds undergo visual and radiographic inspection (i.e., X-ray), as outlined in 49 CFR Part 192, by qualified technicians and inspectors. For welds where NDE is required, the technicians take X-rays of the pipe welds to confirm that the completed welds meet federally prescribed quality standards. If the technician detects any unacceptable flaws, the weld is repaired or cut out, and a new weld is made, as per code requirements.

7. Lowering Pipe into the Trench - Stage 5

Depending on the length of pipe to replace, lowering the welded pipe into the trench requires close coordination and skilled operators (see Figure 9). Using a series of sidebooms (i.e., tractors designed to move pipelines into place), operators simultaneously lift and carefully lower the welded pipe sections into the trench. The bottom of the trench is “shaded” (i.e., covered) with at least six inches of sand to protect the pipe and coating from damage. Lastly, cathodic protection test stations may be installed on the pipeline before backfilling.

8. Field Coating - Stage 5

Pipelines are externally coated to prevent moisture from coming into direct contact with the steel and causing corrosion. Typically, coated pipelines are delivered with uncoated areas three to six inches from each end to prevent the coating from interfering with the welding process. Once the welds are completed, a coating crew coats the remaining portion of the pipeline. Prior to this coating application, the coating crew thoroughly cleans the bare pipe with a power wire brush or a sandblast machine to remove any dirt, mill scale, or debris. The crew then applies the coating and allows it to dry. Once dry, the coating of the pipeline is inspected to verify it is free of defects: it is electronically inspected, or “jeeped,” for faults or voids in the epoxy coating and visually inspected for faults, scratches, or other coating defects.

APPENDIX A

9. Backfilling and Paving - Stage 5

After all welds have passed inspection, coating has been applied, and survey crews have recorded the location of the pipe and various valves/fittings, crews begin the backfilling process. As with previous construction crews, the backfilling crew takes care to protect the pipeline and coating by using a minimum of 12 inches of zero-sack slurry (sand and water mixture) on top of the top pipe. Then the remainder of the backfill material is placed over the pipe. The final step is paving.

10. Hydrostatic Testing - Stage 5

Depending on the varying elevation of the terrain along the pipeline route and the location of available water sources, the pipeline may be divided into sections to facilitate the test. Each section is filled with water and pressured up to DOT requirements and held for a specified period of time to determine if the pipeline meets the design strength requirements and if any leaks are present (see Figures 11 and 12 for hydrotest set-ups). Once a section successfully passes a hydrostatic test, water is emptied from the pipeline and the pipeline is dried to ensure that no water is present when natural gas begins to flow.

The drying out of the pipeline is completed using large compressors and foam tools (pigs). A pig launcher and receiver are installed at the ends to facilitate this process. The team will continue to pass the pig through the system until the desired dew point (i.e., the atmospheric temperature—varying according to pressure and humidity—below which water droplets begin to condense and dew can form) is reached as prescribed by the Engineering Department. Once achieved, the final tie-in and commissioning activities can commence. This drying process usually takes three days, but can take more or less time, depending on the length and geometry of the pipeline. The used water is tested by Environmental Services personnel for disposal purposes. Containers such as Baker Tanks are used to store the water before disposal while water testing results are being evaluated (see Figures 11, 12, and 13). Filtration equipment is used to remove organic and inorganic material to permit disposal levels. The water may be disposed of at a sewer, transported to a disposal facility via a truck, or provided to a third-party for non-potable reuse. How the water is disposed often times depends on permit requirements.

11. Final Tie-in and Commissioning - Stages 5 and 6

Following successful hydrostatic testing and drying process, the final pipeline tie-ins are made and inspected (see Figure 14). The line is then odorized which is a process that will take up to 2 days or more to complete. After odorization is achieved, the tie-in process is completed with flow being opened to all taps. Any customers who were being fed by CNG/LNG have their service switched to being fed from the new pipeline.

APPENDIX A

The process for the abandonment of the original line also needs to take place. It begins by purging, isolating the ends and taps, and permanently decommissioning the line which could take a few days to complete.

12. Cleanup and Restoration - Stages 5 and 6

The final step in the construction process is to restore the street, ROW, easement land and lay-down yard as closely as possible to its original condition. This step involves cleaning up the laydown yard and completing necessary paving repairs or land restoration activities, as required by the issued permit or land owner. Careful attention is paid to mitigating future erosion risk for installations that do not include paving.

****This section describes the hydrotest project activities that differ from replacement project activities.****

Hydrotest Project

The trenching/excavating activities for a hydrotest project involve exposing the pipeline to be tested to complete the following pre-hydrotest construction activities:

- Remove identified pipeline features. The removal process generally involves welding and NDE (see Figure 15).
- Removal of non-piggable pipeline features.
- Removal/replacement of pipeline features that cannot be pressure tested.
- Excavation of tap locations (customer lines, regulator station taps, etc.) that are off the main line to enable isolation.
- Exposure of each end of the pipe to install test heads. This will require a minimum of a 10-foot by 20-foot bell hole.

There is a small amount of replacement work during a hydrotest project that is necessary to isolate the pipe and install the test heads. This replacement activity requires the following:

- The small section of pipe is removed at each end.
- The non-tested line must be welded with a cap that will be cut out after testing is completed.
- The test heads are welded into place and NDE follows.
- The pipe is hydrotested.
- The test heads are cut out and the pig launcher/receiver is installed. The drying process takes place after water is removed. The pig launcher/receiver is removed and a new tested section of pipe is installed. All taps and main line ties are completed using the welding process.

APPENDIX A

Lastly, since the pipeline is removed from service for pressure testing, there may be additional CNG/LNG activities: deliveries, installation, management and eventually removal required for the individual customers fed off the pipeline being tested (see Figure 16).

See the following link for a video describing the process.

<https://www.youtube.com/watch?v=IRFWeTRAcCU>

****The following section describes the PSEP valve enhancement project activities (retrofits or new valve installations/stations) that differ from pipeline replacement project activities.****

PSEP Valve Enhancement Project

The valve enhancement projects submitted in this application are located in both city streets and in rural areas. The urban valve locations typically require additional assembly space, which is frequently larger than existing ROW rights. Therefore, land acquisition activity presents a greater challenge, as compared to pipeline work in streets (see Figure 18).

Some work will occur on SoCalGas and SDGE property which will not always necessitate obtaining a permit. The permits that are obtained may be for assets underground, aboveground or both. The valve work may involve obtaining new ROW or easements agreements for installations in new locations. The aboveground work could be extensive with the commissioning of buildings and other structures to house communications, data panels, etc. (see Figure 17).

The survey and locating activities will include potholing to confirm the depth and alignment of the pipe/valve assembly. Also, the distances of the valve/pipe from sidewalks or other areas will be determined. This information is critical to the vault and actuator designs because of the varying heights and horizontal space requirements for the equipment. At times, these activities may determine whether a pipeline needs to be relocated to accommodate a valve installation/retrofit. Lastly, depending on the type of project installation, land may need to be purchased to accommodate facilities, such as a large valve station that will include small buildings, communication installations, and other structures.

APPENDIX A

Each valve enhancement project involves significant excavation work that differs from replacement or hydrotest projects. Below is a list of possible excavations that may take place on a valve enhancement project:

- Expose the existing valve assembly (all sides) for the installation of a new vault.
- Install a new valve location and associated vault.
- Remove pipeline features, as required.
- Bring in new power/communications lines.
- Install gas control gas piping for sensing functions.
- Prepare the foundation for retaining wall installations for cabinets or to secure the entire facility.
- Install line break cabinets, SCADA buildings, and antennae poles. Install looped grounding systems in the valve station.

Hydrotesting will occur on any new valve assemblies. For some projects the test will take place aboveground in the lay-down yard and for other projects it will occur with the main-line pipe which will involve test heads and pig-launcher/receiver assemblies.

See the following link for a video describing the process.

<https://www.youtube.com/watch?v=Fpv-ENrrHNI>

****The following section provides photographs depicting SoCalGas and SDG&E PSEP construction activities.****

APPENDIX A

Figure 1: Trenching in Urban Location



Figure2: Lowering Pipe in Congested City Area



APPENDIX A

Figure 3: Installing Pipe in Trench with Existing Substructures



Figure 4: Night Work Construction Site



APPENDIX A

Figure 5: Construction Laydown Yard



Figure 6: Shoring



APPENDIX A

Figure 7: Jack and Bore Pit



Figure 8: Jack and Bore Operation



APPENDIX A

Figure 9: Lowering Section of Pipe into Trench



APPENDIX A

Figure 10: Above-Ground Pre-Fabrication of Valve Assembly



APPENDIX A

Figure 11: Hydrotest Equipment



Figure 12: Hydrotest Set Up with Sound Proofing to Minimize Noise Complaints (located behind Baker tank)



APPENDIX A

Figure 13 – Baker Tanks



Figure 14: L-2000 Tie-In Construction



APPENDIX A

Figure 15: Feature to be Removed from L-2000W Before Hydrotest

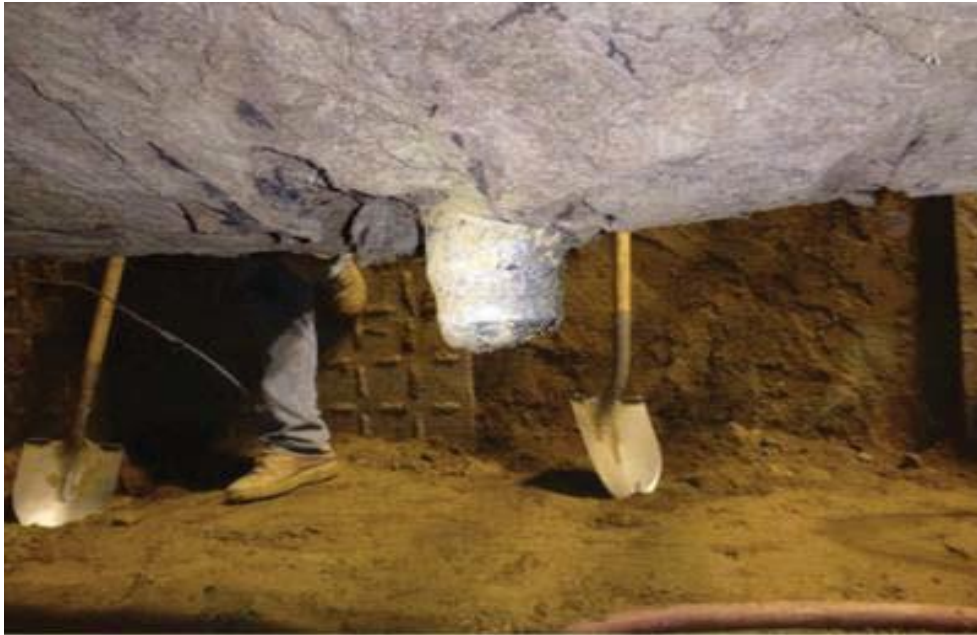

Figure 16: CNG for Temporary Bypass



APPENDIX A

Figure 17: Above-Ground Valve Equipment



Figure 18: Large Valve Station with Numerous Above-Ground Features



WP-G-1 - 13
Appendix B - Glossary

APPENDIX B

GLOSSARY OF TERMS

The following list of acronyms, terms and high level definitions are intended to accompany the workpapers that support SoCalGas and SDG&E's 2018 PSEP Reasonableness Review application and specifically testimony Chapters (II), (III) and (IV). These terms describe cost, gas operations, construction and land use terms that may not be commonly understood. They also provide the full name for less common acronyms that are referenced in these workpapers. This is not a comprehensive or detailed glossary of utility and construction terms. It is assumed that the reader is familiar with basic utility industry and regulatory terms, and, those terms and acronyms have been intentionally omitted from this list.

Acronym	Term	Definition
	5-8s	A work schedule that consists of five working days per week, where eight hours is worked each day.
	5-10s	A work schedule that consists of five working days per week, where 10 hours is worked each day.
	Actuator	A device that causes a valve to move from the open to the closed position or vice versa.
	Alliance Contractor	SoCalGas and SDG&E solicited competitive bids on rates from qualified Electrical Contractors for four geographic regions, and selected contractors to be the "Alliance" contractors for electrical construction activities in each region on PSEP valve projects.
AFUDC	Allowance for Funds Used During Construction	AFUDC is the net cost for borrowed funds used for construction purposes plus a reasonable rate on other funds, such as equity.
ASV	Automatic Shut-off Valve	A valve that has electric or gas powered actuators to operate the valve automatically based on data sent to the actuator from pipeline sensors. The sensors send a signal to close the valve based on predetermined criteria, generally based on pipeline operating pressure or flow rate.
	Ball Valve	A valve that is opened and closed by pivoting a ball with a hole that fits into a cup-shaped opening to control gas flow.
	Beam and Lag Engineered Shoring System	An excavation support technique where vertical piles (beams) are either driven or lowered into a drilled excavation and grouted at regular intervals along the proposed excavation location. Wood boards (lagging) are placed between the piles as excavation proceeds.
	Bell Hole	An excavation that minimizes surface disturbance and provides sufficient room for examination or repair of buried facilities.

APPENDIX B

Acronym	Term	Definition
BMP	Best Management Practices	Activities, maintenance procedures, and other management practices to prevent or reduce the pollution of waters of the United States. BMP's are also operating procedures and practices to control facility site runoff, spillage or leaks, sludge or waste disposal, or drainage from raw material storage.
	Block Valve	A mechanical device (valve) installed in a pipeline that can be closed to block the flow of gas through the line.
	Blowdown	A controlled activity to release gas from an active pipe section to isolate the pipe section for maintenance or construction activities.
	Blow-off Valve	A valve that is utilized to reduce pressure in the pipeline by venting gas to atmosphere.
	Bollards	Short vertical post structures to control or direct road traffic.
	Bore Pit	An excavation that allows for the boring equipment to either send or receive pipe which has been bored through earth.
	Boring	The act or process of making or enlarging a hole.
	Branch Connection	A fitting that provides an outlet from a larger pipe to a smaller one (or one of the same size).
	Bridle	A bridle pipeline system is designed to allow alternative flow to isolate a section or entire pipeline from service. It can allow alternative feed options during isolation activities.
	Bypass	Delivery of gas through alternate piping that allows for a section of pipeline to be isolated from the system.
	Capital	Costs of new additions of plant, property and equipment that have a useful life of more than one year. New additions include any costs incurred to construct, install and/or prepare plant, property, and equipment for its intended use. Capital-related costs include depreciation, taxes and return associated with the cost of the assets.
	Category 1	Pipeline segments that have documentation of hydrostatic pressure testing to at least 1.25 times the MAOP.
	Category 2	Pipeline segments that have documentation of pressure testing to at least 1.25 times MAOP using a medium other than water.
	Category 3	Pipeline segments for which documentation validates that the highest in-service operating pressure is at least 1.25 times the current MAOP.

APPENDIX B

Acronym	Term	Definition
	Category 4	Pipelines segments that lack sufficient documentation of a post-construction strength test to at least 1.25 times the MAOP.
	Check Valve	A valve that allows liquids or gases in a pipeline to flow in one direction and closes to prevent flow in the opposite direction. These types of valves are used to prevent reverse-flow or back-flow in the event of a pipeline leak or abnormal operating occurrence.
	Class 1	An offshore area; or any class location unit that has ten or fewer buildings intended for human occupancy.
	Class 2	Any class location unit that has more than ten but fewer than 46 buildings intended for human occupancy.
	Class 3	A Class Location unit that has 46 or more buildings intended for human occupancy; or an area where the pipeline lies within 100 yards (300 feet) of either a building or a small, well-defined outside area (such as a playground, recreation area, outdoor theatre, or other place of public assembly) that is occupied by 20 or more persons on at least five days a week for ten weeks in any 12-month period. (The days and weeks need not be consecutive.)
	Class 4	A class location unit where buildings with four or more stories above ground are prevalent.
	Class location or Class	Class locations are a method of differentiating risk along gas pipelines. Regulations for gas transmission pipelines establish pipe strength requirements based on population density near the pipeline. Locations along gas pipelines are divided into classes from 1 (rural) to 4 (densely populated) and are based on the number of buildings or dwellings for human occupancy.
	Coal Tar	A water-resistant coal based material that is used as a coating to protect the pipelines against underground corrosion.
	Coal Tar Wrap	A thermoplastic polymeric coating produced from the plasticization of coal tar pitch, coal and distillates, followed by the addition of inert filler.
	Cold Tie-In	The method of connecting new pipe to existing pipe that is shut-down and not pressurize during the tie-in procedure.
CSED	Combination Service Entrance Device	Enclosure for electric watt-hour meter including main and branch circuit breaker.

APPENDIX B

Acronym	Term	Definition
	Competitive Bid	A procurement method in which the selection of the successful bidder is based on submitted bids from vendors or contractors for goods or services.
	Concrete Collar	A collar of reinforced concrete which is placed around an existing column so that it can be jacked up; the shrinkage of the concrete causes it to grip the column firmly.
CMS	Construction Management System	Gas distribution planning system used by SoCalGas's Field Operations.
COZEEP	Construction Zone Enhanced Enforcement Program	The Construction Zone Enhanced Enforcement Program (COZEEP) is a Statewide Interagency Agreement (contract) between Caltrans and the California Highway Patrol (CHP). It enables the Department to hire CHP officers and vehicles to patrol project construction zones.
C/P	Control and Power only (ASV to RCV Conversion)	Installation of power and communications to convert a valve from ASV to RCV technology.
	Control Valve	A valve used to control conditions such as flow, pressure, and liquid level, by fully or partially opening or closing in response to signals received from controllers that compare a "set-point" to a "process variable," whose value is provided by sensors that monitor changes in such conditions.
	Coupon	A sample piece of material cut out of a pipeline.
	Criteria	Class 3 & 4 locations and Class 1 & 2 High Consequence Areas (HCA).
	Dewater	The removal of the test water from a pipeline.
	De-rate	Lowering the Maximum Allowable Operating Pressure (MAOP).
	Double Submerged Arc-Welded (DSAW)	A welding process wherein the arc weld is submerged under flux while the welding takes place. Both inside and outside welds are required and are usually accomplished in separate processes, hence the word "double."
	Direct Costs	Direct costs are for those activities and services that support execution of a specific project, such as labor costs, which include salaries of Company employees, and non-labor costs, which include costs for contract labor, purchased services, and materials required to complete a specific project.
	Disbonded	Any loss of bond between the protective coating and steel pipe as a result of coating adhesion failure, chemical reaction, mechanical damage, or hydrogen concentrations.

APPENDIX B

Acronym	Term	Definition
	Drain	A capped off section of a gas pipeline installed in a manner designed to capture debris or moisture in the gas pipeline, where it can be cleaned out.
	Drip Leg	An additional section of gas pipeline installed in a manner designed to capture debris or moisture in the gas pipeline, where it can be cleaned out.
	Drip Pot	A drain installed on the bottom of a pipeline to capture and remove liquid and solid debris pushed along the pipeline.
	Dual Run Pipe	Two pipelines that run parallel to each other in the same system; also known as a double barrel.
	Elbow	A fitting that is bent in a manner designed to produce a 90 degree change in the direction of flow in the pipe.
ETS	Electrolysis Test Station	A test station installed on a cathodically protected pipeline used to perform potential, current or resistance measurements.
	Encroachment	An "encroachment" is any tower, pole, pole line, pipe, pipeline, fence, billboard, stand or building, or any structure, which is in, under, or over any portion of the street or highway rights of way."
ECDA	External Corrosion Direct Assessment	A four-step process that includes pre-assessment, indirect inspection, direct examination, and post assessment to evaluate the threat of external corrosion to the integrity of a pipeline.
	Feature Study	A study that provides the physical components of a pipeline and the attributes associated with those components.
	Flow Meter	An instrument used for measuring the flow rate of gas.
	Flow Valve	A control valve that regulates the flow or pressure of gas.
	Operating Districts	Organizations responsible for operation and maintenance of a gas pipeline.
	Gate Valve	A pipeline valve consisting of a flat or wedge-shaped gate that can be lowered into a seat to seal off the line or raised into an external recess so that the full area of the line is open.

APPENDIX B

Acronym	Term	Definition
GMA	General Management and Administration	Programmatic costs incurred in support of PSEP project execution. The PSEP GMA tracks, monitors, and allocates PSEP support costs to the various PSEP projects. See Chapters V and VI for further details.
GPR	Ground Penetrating Radar	A geophysical assessment method that uses radar pulses to image the subsurface. This nondestructive method uses electromagnetic radiation in the microwave band (UHF/VHF frequencies) of the radio spectrum, and detects the reflected signals from subsurface structures.
	Guy Wire	A tensioned cable designed to add stability to a free-standing structure.
HCA	High Consequence Area	An area where a pipeline release could have greater consequences to health and safety or the environment.
	High Pressure	Pressure greater than 60 psig.
	Holiday Testing (jeeping)	The act of assessing a pipeline using a holiday detector or “jeep.” Holiday detectors are employed in the non-destructive detection and location of pinholes, holidays, bare spots or thin points in protective coatings applied for corrosion protection over metal or concrete (conductive) surfaces. A holiday detector is also known as a porosity detector, pinhole tester, spark tester, jeep tester or jeeper.
HDD	Horizontal Directional Drilling	A minimal impact, trenchless method of installing underground pipe in a relatively shallow arc or radius along a prescribed underground bore path.
	Hot Tap	A method of making a connection to existing piping without the interruption of emptying that section of pipe. The pipe can continue to be in operation while maintenance or modifications are being done to it.
	Hot Tie-in	The method of connecting new pipe to existing pipe that is not shut-down and is pressurized during the tie-in procedure.
	H-pile	A type of shoring that utilizes steel beams “H-Piles” that are driven into the ground for purposes of shoring.
	Incidental take permits	A permit issued under Section 10 of the United States Endangered Species Act (ESA) to private, non-federal entities undertaking otherwise lawful projects that might result in the “take” of an endangered or threatened species. “Take” is defined by the ESA as harass, harm, pursue, hunt, shoot, wound, kill, trap, capture, or collect any threatened or endangered species.
	Indirects	Costs for activities and services that are associated with direct costs—such as payroll taxes, property taxes and

APPENDIX B

Acronym	Term	Definition
		pension and benefits —and benefit a project but are not directly charged to a project.
ILI	In-line Inspection	Inspection of a pipeline using a device (“smart pig”) that travels through the pipeline internally and detects signals caused by pipeline flaws.
	Jack-and-Bore	Method of horizontal boring construction. Construction crews drill a hole underground horizontally between two points without disturbing the surface between sending and receiving pits.
	K-rail	A modular concrete or plastic barrier employed to separate lanes of traffic.
	Lateral	A segment of a pipeline that branches off a main or transmission line to transport gas to a termination point.
	Linebreak	Device that senses the rate of pressure differential in a pipeline to detect a possible break and activates a valve to close.
	Line-seasoning	Also referred to as “pickling” the line, the pre-odorization of gas pipelines to maintain the odorant level of the pipeline.
	Loaded Costs	Direct costs and indirect costs.
MLV	Mainline Valve	A valve positioned at a location along the pipeline system that can be closed down to isolate a line section in an emergency or for maintenance purposes.
MAOP	Maximum Allowable Operating Pressure	The maximum pressure at which a pipeline or segment of a pipeline may be operated under 49 CFR 192.
MRC	Measurement Regulation and Control	A department within SoCalGas and SDG&E that manages meter and regulation activities (<i>e.g.</i> , regulator station operation).
	Medium Pressure	Pressure equal to or greater than 10 psig, but not more than 60 psig.
	Midden Soil	A midden is an old dump for domestic waste which may consist of animal bone, human excrement, botanical material, mollusc shells, sherds, lithics (especially debitage), and other artifacts and ecofacts associated with past human occupation. Midden soils are formed from composted material accumulated via incidental human activity (often in middens).
	Miter bend	A joint made by beveling each of two parts to be joined, usually at a 45° angle, to form a corner, usually a 90° angle.

APPENDIX B

Acronym	Term	Definition
A/AG	New Actuator Above Ground	Installation of a new valve actuator above ground.
A/VT	New Actuator in Vault	Installation of a new valve actuator below ground (housed inside a vault).
NV/AG	New Valve and Actuator Above Ground	Installation of a new valve and actuator above ground.
NV/NP	New Valve and Actuator in Replaced Pipe	Installation of a new valve and actuator on a new section of pipeline.
NV/VT	New Valve and Actuator in Vault	Installation of a new valve and actuator below ground (housed inside a vault).
	Nipple	A short stub of pipe, usually composed of threaded steel, brass, chlorinated polyvinyl chloride (CPVC) or copper; occasionally just bare copper.
NDE	Nondestructive Examination or Nondestructive Testing (NDT)	Evaluation of a pipeline using a number of inspection methods that are typically performed manually on exposed pipeline surfaces without causing damage, such as radiography, ultrasonic inspection, or magnetic particle testing.
NOP	Notice of Operation	Notification from a project team to the Accounting department that an asset has been placed in service. In some instances, NOP may also refer to the date an asset is placed in service
O&M	Operations and Maintenance	Costs for activities related to the operation or maintenance of an asset.
	Overheads	See Indirects.
	Performance Partner	SoCalGas and SDG&E solicited competitive bids on rates from qualified pipeline construction contractors for four geographic regions, and selected contractors to be the "Performance Partner" for each geographic region.
	(Pierced) Hump Bands	A method of repair and reinforcement of pipelines damaged due to internal and/or external corrosion, gouges, dents, cracks and defective welds. Piercing refers to the action that allows gas in the expanded chamber.
PIG	Pipeline Inspection Gauge or "Smart Pig"	A device that is sent through a pipeline internally to detect signals caused by pipeline flaws.
	Piggable	A pipeline that is capable of being evaluated using currently-available in-line inspection technology.

APPENDIX B

Acronym	Term	Definition
PI	Pipeline Integrity	Department within SoCalGas and SDG&E that manages/oversees certain aspects of pipeline integrity and compliance work.
	Plug valve	Is shaped like a cylinder or cone and can be rotated inside the valve body to control flow of fluids.
	Plume Study	An evaluation to determine minimum required horizontal separation distance between a temporary blowdown-stack and the nearest potential ignition source during a blowdown operation.
	Pneumatic Actuator	Converts energy (typically in the form of compressed air) into mechanical motion.
	Porosity	Void space within a weld due to gas formations that did not escape prior to the weld solidification.
	Potholing	An excavation used to locate known subsurface structures. Potholing is most often used when a contractor needs to verify the depth, size or type of underground utility.
PCV	Pressure Control Valve	A control valve used to control pressure by fully or partially opening or closing in response to signals received from controllers that compare a "set-point" to a "process variable" whose value is provided by sensors that monitor changes in such conditions.
PCF	Pressure Control Fittings	Fittings used to stop or redirect flow in an active pipeline system.
PRV	Pressure Relief Valve	A mechanical safety device that provides protection to a pressurized container, such as a pipeline, by reducing the internal pressure by releasing it outside the container.
	Pressure Transducers	A device that measures pressure in a liquid, fluid, or gas.
	Pressure Transmitter	A device that measures pressure in a liquid, fluid, or gas and communicates signal.
	Producer	An entity that produces natural gas as a byproduct or primary product of oil production operations.
PLC	Programmable Logic Controller	A digital computer used for automation of electromechanical processes, such as control of machinery on factory assembly lines, amusement rides, or light fixtures.
	Pup	A short length of pipe.
	Reducer	The component in a pipeline that reduces the pipe size from a larger to a smaller bore (inner diameter).

APPENDIX B

Acronym	Term	Definition
	Regulator Station	Equipment installed on a pipeline for the purpose of automatically reducing and regulating the gas pressure in the downstream pipeline.
RCV	Remote Control Valve	A valve equipped with electric or gas powered actuators to operate (open or close) the valve based on an order (signal) from a remote location, such as a gas control room.
RER	Request for Engineering Review	Process by which the Engineering department within SoCalGas and SDG&E reviews pipeline change requests and determines system impacts based on engineering analysis.
RFI	Request for Information	A process initiated by the contractor used for requesting information regarding clarification, interpretation, or omission in issued documents; resolving conflicting instructions received; or reporting changed conditions encountered during the course of work.
ROW	Right-of-Way	A strip of land on which pipelines, railroads, power lines, and other similar facilities are constructed. It secures the right to pass over property owned by others.
	Ripping	A term used to describe the practice of mechanically plowing fields.
ERW	Electric Resistance Welding	A group of welding processes that produce coalescence of faying surfaces where heat to form the weld is generated by the electrical resistance of material combined with the time and the force used to hold the materials together during welding.
	Segment	A length of pipeline that has unique characteristics. A section of pipe can be made up of multiple segments.
	Service Valve	A valve used to separate one piece of equipment from another in a natural gas system and typically refers to the separation between a customer and company's piping.
	Single-Sourced	A contract for the purchase of goods (materials) or services that is entered into by the Company with a single vendor without first obtaining pricing from other potential vendors.
SSAW	Single Submerged Arc-Welded	An arc welding process that requires a continuously fed consumable solid or tubular (metal cored) electrode. The molten weld and the arc zone are protected from atmospheric contamination by being "submerged" under a

APPENDIX B

Acronym	Term	Definition
		blanket of granular fusible flux consisting of lime, silica, manganese oxide, calcium fluoride, and other compounds. When molten, the flux becomes conductive, and provides a current path between the electrode and the work. This thick layer of flux completely covers the molten metal thus preventing spatter and sparks as well as suppressing the intense ultraviolet radiation and fumes.
	Slide rail	A type of shoring that is modular and utilized for trench shoring excavations.
	Slot trenching	The process of digging narrow trenches for installing pipes, cables or other in-ground utilities.
	Slurry	A slurry is a thin wet mud or cement or, in extended use, any fluid mixture of a pulverized solid with a liquid (usually water).
SCORE /DBE	Smaller Contractor Opportunity Realization Efforts/Diverse Business Enterprise	A multi-team approach to expand the pool of smaller diverse businesses in our supplier base
	Sole-Sourced	A contract with a supplier for the purchase of goods (materials) or services that is entered into by the Company without first obtaining pricing from other vendors because the supplier is the only source.
SMYS	Specified Minimum Yield Strength	The minimum yield strength prescribed by the specification under which pipe is purchased from the manufacturer.
	Spool	Piece of pipe flanged on both ends that can be removed and re-installed.
	Static Head	The height of a column of water at rest that would produce a given pressure.
	Stopp (Pressure Control Fitting)	A plug that can stop the flow of gas.
SWPPP	Stormwater Pollution Prevention Plan	A fundamental requirement of stormwater permits that identifies potential sources of pollution that may reasonably be expected to affect the quality of storm water discharges from the construction site, describes the practices to be used to reduce pollutants in storm water discharges from the construction site, and helps assure compliance with the terms and conditions of the permit (when the plan is designed for the individual site, and is fully implemented).
	Subpart J	Subpart J refers to 49 CFR Part 192, Subpart J – Test requirements, which is a section of the Code of Federal Regulations (CFR) that prescribes minimum leak-test and strength-test requirements for pipelines.

APPENDIX B

Acronym	Term	Definition
SCADA	Supervisory Control and Data Acquisition	A system for remote monitoring and control that operates with coded signals over communication channels.
SL	Supply Line	A distribution supply line can be either a transmission line or a distribution main and is operated at a pressure more than 60 psig, and supplies one or more distribution regulator stations, or supplies three or more customers.
	Supply Line Lateral	A line that functions at higher than 60 psig with no pressure regulation at the off-take from the source supply line.
	System Average Cost	The average cost per mile to pressure test a pipeline segment. Used to determine certain disallowances per D.14-06-007 and D.15-12-020.
	Tap Valve	A welded branch connection with valve made to a pipeline in the form of a single connection to supply or transfer gas between pipeline systems.
TPE	Target Price Estimate	The estimate for construction contractor costs that is negotiated between the Performance Partner and a third-party estimator and approved by SoCalGas/SDG&E.
	T-Cuts	Cuts made to asphalt after the backfill is completed for structural strength and sealing against water intrusion.
	Tee	A pipe fitting that is T-shaped having two outlets, at 90° to the connection to the main line. It is used for connecting pipes of different diameters or for changing the direction of pipe runs.
TRE	Temporary Right of Entry	Temporary permission to enter and perform various activities on private property which include but are not limited to land and environmental surveys to support planning and design and contractor laydown yards and work space in support of construction.
	Test Head	A piece of equipment through which water is pumped to conduct a pressure test. A pipeline that will be pressure tested has a test head welded to the end of a pipeline segment.
T&E	Time and Expense	A contract for construction, product development or other services in which the employer agrees to pay the contractor based upon the time spent by the contractor's employees and subcontractors employees to perform the work, and for expenses realized as a result of the contracted project.

APPENDIX B

Acronym	Term	Definition
T&M	Time and Material	A contract for construction, product development or other services in which the employer agrees to pay the contractor based upon the time spent by the contractor's employees and subcontractors employees to perform the work, and for materials used in the construction (plus the contractor's mark-up).
	Time-and-material, not-to-exceed	A Time and Material contract that includes a cost cap (<i>i.e.</i> , limits the maximum amount that can be charged by the contractor).
	Transite	A generic term for asbestos-cement products, including boards and pipes.
	Turnover	A term used to indicate a project team has no further activities to be addressed on a project and the asset is returned or "turned over" to the operating department.
	Type C Soil	The least stable type of soil, which includes granular soils in which particles do not stick together and cohesive soils with a low unconfined compressive strength; 0.5 tons per square foot or less. Examples of Type C soil include gravel and sand.
	Up-rate	Increase of the Maximum Allowable Operating Pressure (MAOP).
	Valve	A device that controls the flow of natural gas.
	Vault	An underground room/space that provides access to subterranean equipment, such as valves for water or natural gas pipes, or switchgear for electrical or telecommunications.
	Wedding bands	A welded sleeve on a pipeline that can be used to repair gas transmission pipelines. It allows for full encirclement repair over damage/defects.
WOA	Work Order Authorization	A utility form that summarizes and documents approval to proceed with execution of a project. A "Phase 1 WOA" authorizes a project team to conduct preliminary design and planning work for a project. A "Phase 2 WOA" is based on a fully loaded estimate of project costs
	Wrinkle Bend	A pipe bend produced by a field machine or controlled process which may result in abrupt contour discontinuities on the inner radius.

WP-III-A1 - A1037

Pipeline Pressure Test/Replacement Projects

PIPELINE PROJECTS

Table 1 – Pipeline Hydrotest and Replacement Projects for 2018 Reasonableness Review

Pipeline Workpaper Title	Project Scope (miles, rounded)			Utility	Workpaper Page
	Hydrotest	Replace	Abandon		
30-18 Section 1 and 3 Replacement Project		2.008	0.003	SoCalGas	WP-III-A1 - A29
33-120 Section 3 Replacement Project		0.516		SoCalGas	WP-III-A30 - A47
36-1002 Replacement Project		0.034		SoCalGas	WP-III-A48 - A61
36-9-09 North Section 1 Replacement Project		5.975		SoCalGas	WP-III-A62 - A85
36-9-09 North Section 3 Replacement Project		2.956		SoCalGas	WP-III-A86 - A109
36-9-09 North Section 4A and 4B Replacement Project		1.034		SoCalGas	WP-III- A110 - A136
36-9-09 North Section 7A and 7B Replacement Project		4.260		SoCalGas	WP-III-A137 - A170
37-07 Replacement Project		3.222		SoCalGas	WP-III-A171 - A189
37-18 Sections 1,2,3,4 and 5 Replacement Project		4.291		SoCalGas	WP-III-A190 - A216
38-200 Replacement Project		0.369		SoCalGas	WP-III-A217 -A234
38-501 Replacement Project		2.410	0.013	SoCalGas	WP-III-A235 - A263
38-504 Replacement Project		0.377		SoCalGas	WP-III-A264 - A280
38-512 Replacement Project		4.901	0.059	SoCalGas	WP-III-A281 - A308
38-514 Replacement Project		2.930		SoCalGas	WP-III-A309 - A325
38-931 Replacement Project		0.997	0.018	SoCalGas	WP-III-A326 - A350
41-17 Replacement Project			1.790	SoCalGas	WP-III-A351 - A365
41-116 Replacement Project		0.009		SoCalGas	WP-III-A366 - A380
41-6000-2 Replacement Project		11.706	0.035	SoCalGas	WP-III-A381 - A405
43-121 North Section 1 Replacement Project		1.009		SoCalGas	WP-III-A406 - A429
43-121 South Replacement Project		1.475	0.002	SoCalGas	WP-III-A430 - A459
44-137 Replacement Project		1.031	0.008	SoCalGas	WP-III-A460 - A480
44-687 Replacement Project		0.303		SoCalGas	WP-III-A481 – A499
44-720 Replacement Project		1.482	0.011	SoCalGas	WP-III-A500 - A519
49-15 Replacement Project		2.779	0.011	SDG&E	WP-III-A520 - A552
49-28 Replacement Project		2.600		SDG&E	WP-III-A553 - A580
85 South Newhall Avenue Replacement Project		0.085	0.089	SoCalGas	WP-III-A581 - A603
2000-West Santa Fe Springs Replacement Project		0.150	0.050	SoCalGas	WP-III-A604 - A626
31-09 Hydrotest Project	0.188	0.014	0.011	SoCalGas	WP-III-A627 - A647
32-21 Section 1 Hydrotest Project	1.479	0.082		SoCalGas	WP-III-A648 - A669
32-21 Section 2 Hydrotest Project	1.560	0.035	0.007	SoCalGas	WP-III-A670 - A688
32-21 Section 3 Hydrotest Project	2.381	0.010		SoCalGas	WP-III-A689 - A706
37-18-F Hydrotest Project	2.044	0.021	0.019	SoCalGas	WP-III-A707 - A727
49-11 Hydrotest Project	0.878	0.082		SDG&E	WP-III-A728 - A746
406 Section 3 Hydrotest Project	0.426	0.007		SoCalGas	WP-III-A747 - A770

Table 1 – Pipeline Hydrotest and Replacement Projects for 2018 Reasonableness Review (Continued)

Pipeline Workpaper Title	Project Scope (miles, rounded)			Utility	Workpaper Page
	Hydrotest	Replace	Abandon		
2000-C Hydrotest Project	7.498	0.087		SoCalGas	WP-III-A771 - A800
2001 West-B Hydrotest Project	1.789	0.011		SoCalGas	WP-III-A801 - A824
2003 Section 2 Hydrotest Project	0.085	0.009		SoCalGas	WP-III-A825 - A841
36-9-09 North Section 5A Hydrotest and Replacement Project	0.572	0.914	0.007	SoCalGas	WP-III-A842 - A864
49-13 Replacement and Hydrotest Project	1.936	1.239		SDG&E	WP-III-A865 - A888
404 Sections 1, 2, 2A, 3, 3A, 4&5, 8A and 9 Replacement and Hydrotest Projects	12.000	0.356	0.298	SoCalGas	WP-III-A889 - A947
1004 Hydrotest and Replacement Projects	8.574	0.395	0.063	SoCalGas	WP-III-A948 - A979
36-9-09 JJ Abandonment Project		0.009	0.453	SoCalGas	WP-III-A980 - A1000
36-9-09 South Abandonment Project		0.005	1.235	SoCalGas	WP-III-A1001 - A1019
Kern Wildlife Bundle Abandonment Project			15.225	SoCalGas	WP-III-A1020 - A1037

Pipeline Safety Enhancement Plan Final Report
Supply Line 30-18 Section 1 and 3 Replacement Project

I. SUPPLY LINE 30-18 SECTION 1 AND 3 REPLACEMENT PROJECT

A. Background and Summary

Supply Line 30-18 is a predominantly [REDACTED] diameter transmission line that runs approximately 4 miles through a residential and commercial industrial area within the City of Carson to the City of Torrance. The pipeline is primarily routed across a Class 3 location. This report describes the activities associated with the Supply Line 30-18 Section 1 and 3 Replacement Project that consists of the Replacement of 2.011 miles of pipeline, including an approximately 190 foot jack and bore under a creek crossing, installation of four mainline valves (MLVs), installation of a 41 foot bypass line, replacement of 7 feet of pipeline, and the removal of an existing valve on Supply Line 37-18-F. The specific attributes of this Project are detailed in Table 1 below. Supply Line 30-18 Section 2 will be included in a future reasonableness review due to complex design and permitting processes delaying execution. The total loaded cost of the Project is \$28,281,200.

The Supply Line 30-18 Section 1 and 3 Replacement Project is a component of the Gardena Bundle that comprises of five PSEP projects. SoCalGas and SDG&E bundled these projects to coordinate schedules and reduce costs for customers by sharing a laydown yard, optimizing the use of construction crews to minimize downtime, and effectively managing the engineering, planning contractor, and company resources. The other PSEP projects in the Gardena Bundle are Supply Line 37-07, Supply Line 37-18, Supply Line 37-18-F, and Supply Line 37-18-K.

Pipeline Safety Enhancement Plan Final Report
Supply Line 30-18 Section 1 and 3 Replacement Project

Table 1: General Project Information

Project Name		Supply Line 30-18 Section 1		
Project Type		Replacement		
Length		2.003 miles		
Location		City of Carson		
Class		3		
MAOP (<i>confidential</i>)		[REDACTED]		
Pipe Vintage		1943		
Construction Start		07/14/2014		
Construction Finish		02/12/2016		
Original Pipe Diameter (<i>confidential</i>)		[REDACTED]		
New Diameter (<i>confidential</i>)		[REDACTED]		
Original SMYS ¹ (<i>confidential</i>)		[REDACTED]		
New SMYS (<i>confidential</i>)		[REDACTED]		
Project Name		Supply Line 30-18 Section 3		
Project Type		Replacement		
Length		0.008 miles		
Location		City of Los Angeles and Los Angeles County		
Class		3		
MAOP (<i>confidential</i>)		[REDACTED]		
Pipe Vintage		1943		
Construction Start		10/31/2016		
Construction Finish		12/20/2016		
Original Pipe Diameter (<i>confidential</i>)		[REDACTED]		
New Diameter (<i>confidential</i>)		[REDACTED]		
Original SMYS ² (<i>confidential</i>)		[REDACTED]		
New SMYS (<i>confidential</i>)		[REDACTED]		
Project Costs (\$)		Capital	O&M	Total
Loaded Project Costs		28,281,200	-	28,281,200
Disallowed Costs		-	-	-

¹ Highest percentage of Specified Minimum Yield Strength (SMYS) of Category 4 Criteria pipe.

² Ibid.

Pipeline Safety Enhancement Plan Final Report
 Supply Line 30-18 Section 1 and 3 Replacement Project

B. Maps and Images

Figure 1: Overview Map of the Gardena Bundle

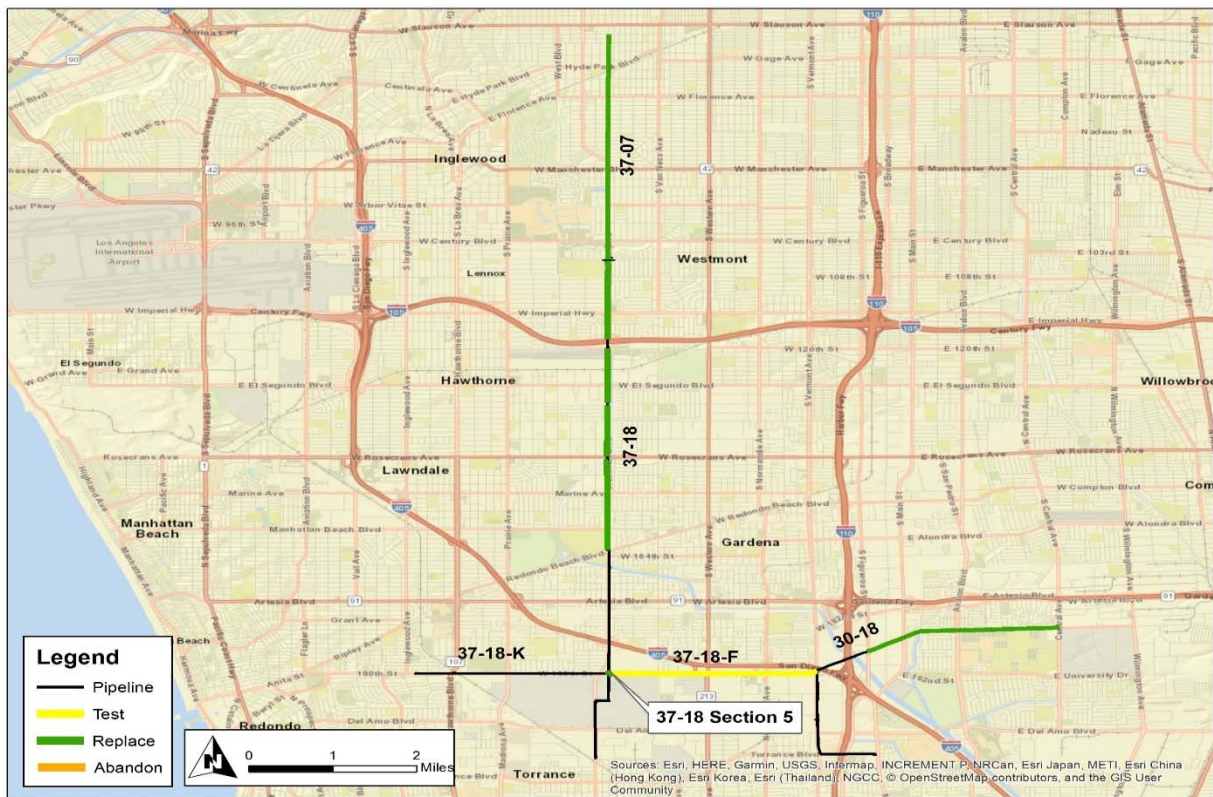

Pipeline Safety Enhancement Plan Final Report
 Supply Line 30-18 Section 1 and 3 Replacement Project

Figure 2: Satellite Image of Supply Line 30-18 Section 1 Replacement Project

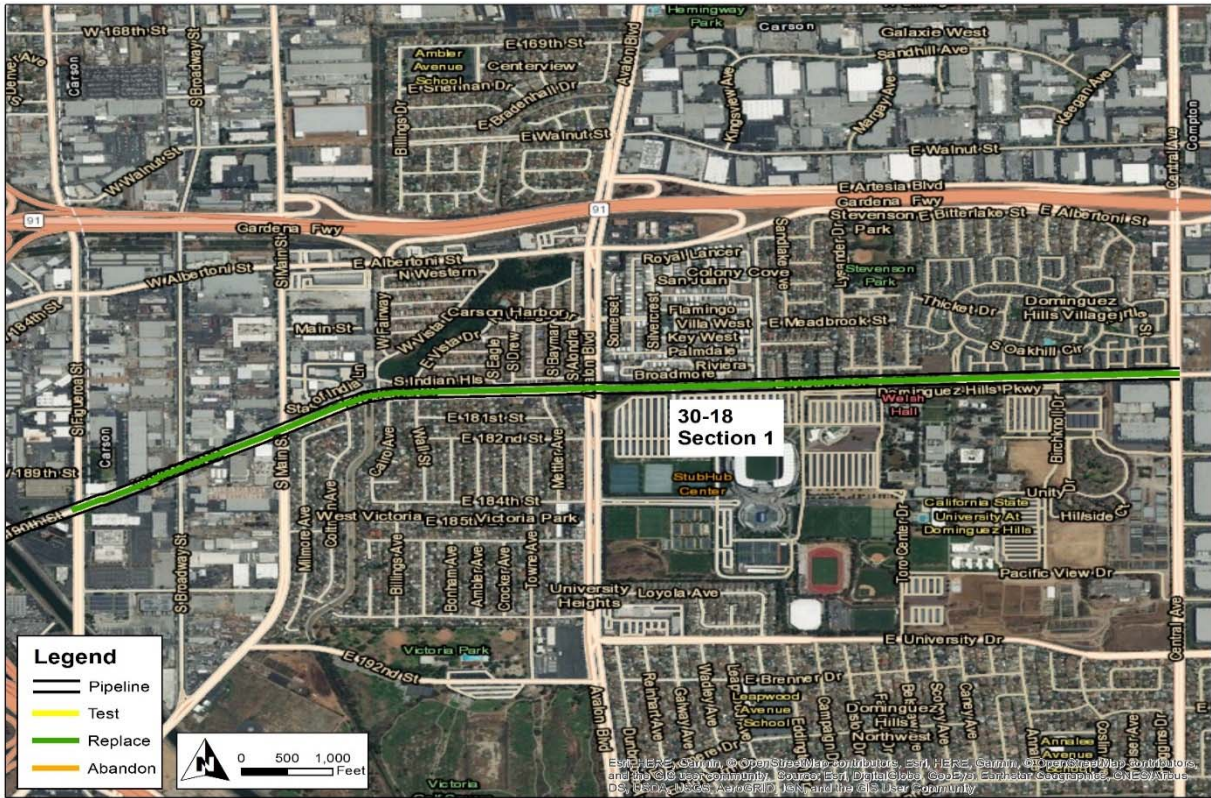

Pipeline Safety Enhancement Plan Final Report
 Supply Line 30-18 Section 1 and 3 Replacement Project

Figure 3: Overview Map of Supply Line 30-18 Section 1 Replacement Project



Pipeline Safety Enhancement Plan Final Report
Supply Line 30-18 Section 1 and 3 Replacement Project

Figure 4: Satellite Image of Supply Line 30-18 Section 3 Replacement Project



Pipeline Safety Enhancement Plan Final Report
Supply Line 30-18 Section 1 and 3 Replacement Project

Figure 5: Overview Map of Supply Line 30-18 Section 3 Replacement Project

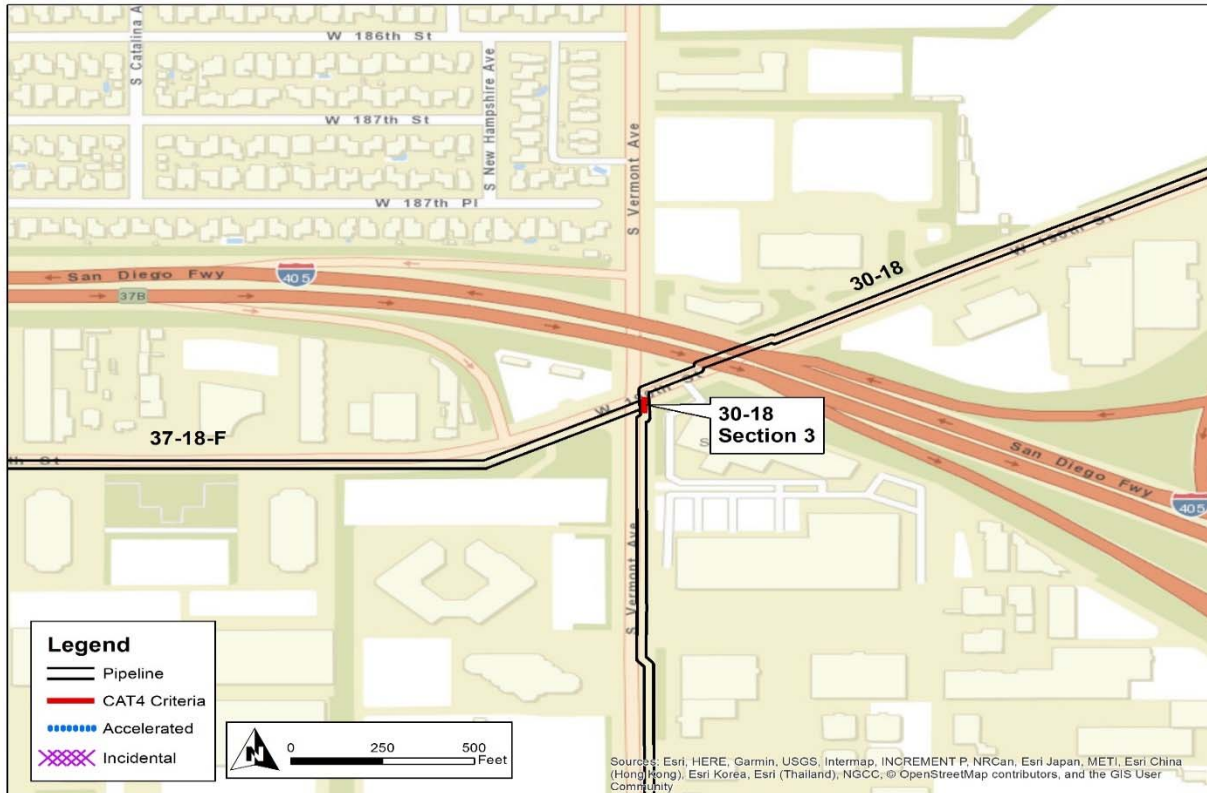

Pipeline Safety Enhancement Plan Final Report
Supply Line 30-18 Section 1 and 3 Replacement Project

II. ENGINEERING, DESIGN, AND PLANNING

A. Project Scope

Table 2: Mileage Information

	Criteria	Accelerated ³	Incidental	New	Total ⁴
Final Mileage ⁵	1.669 mi.	0.024 mi.	0.278 mi.	0.040 mi.	2.011 mi.
	8,812 ft.	128 ft.	1,470 ft.	209 ft.	10,619 ft.

SoCalGas and SDG&E presented a conceptual project scope in workpapers supporting the 2011 PSEP filing.⁶ Prior to initiating execution of the Project in 2014, SoCalGas and SDG&E reviewed existing pipeline records to validate the scope of the Project. During the Engineering, Design, and Planning phase, SoCalGas and SDG&E further refined the scope. This progression of project scope is summarized as follows:

1. 2011 PSEP Filing: SoCalGas and SDG&E identified Supply Line 30-18 as a Phase 1A Replacement Project comprised of 2.139 miles Category 4 Criteria pipe and 0.445 miles of Accelerated pipe.
2. Scope Validation: Through scope validation activities, after the 2011 filing and before initiating execution of the Project, SoCalGas and SDG&E successfully reduced the scope of the Supply Line 30-18 Project by 0.449 miles of Category 4 Criteria pipe.

³ Accelerated mileage includes Phase 2B pipe. Phase 2B includes pipelines without record of a pressure test to modern-Subpart J-standards (Phase 2B). The Accelerated mileage was included to realize efficiencies and to enhance project constructability.

⁴ Values may not add to total due to rounding.

⁵ Includes Criteria and New pipe installed on Supply Line 37-18-F.

⁶ See Amended PSEP of SoCalGas and SDG&E, submitted December 2, 2011, in R.11-02-019 and subsequently transferred to A.11-11-002.

Pipeline Safety Enhancement Plan Final Report
Supply Line 30-18 Section 1 and 3 Replacement Project

3. Engineering, Design, and Constructability:
 - a. Based on constructability, coordination, and permitting requirements for certain portions along the replacement length, the Project Team separated the Project into three replacement sections.
 - b. The Project Team planned Section 2⁷ to occur at a later time due to the more detailed permitting and approval process required for the horizontal directional drill (HDD) crossing of the Dominguez Channel and Caltrans Interstate 110 and Interstate 405.
 - c. Section 3 includes replacement of 7 feet of Category 4 Criteria pipe on Supply Line 37-18-F because it could not be replaced during the Supply Line 37-18-F Hydrotest Project due to system reliability constraints. This replacement also completed removal of an existing valve that was replaced during the Supply Line 37-18-F Hydrotest Project.
 - d. The Project Team included Incidental mileage in order to make the entire length of the replacement pipeline piggable.
4. Final Project Scope: The final project scope for Section 1 consists of a 2.003 mile Replacement on Supply Line 30-18 and installation of two new MLVs and three new lateral valves. New mileage accounted for the offset required for the crossing at McKinley Channel. The final project scope for Section 3 consists of a 0.008 mile Replacement between Supply Line 30-18 and Supply Line 37-18-F containing a new 41 foot long bypass connection to Supply Line 37-18-F to maintain service to customers and installation of two new MLVs on Supply Line 30-18.

⁷ Supply Line 30-18 Section 2 will be included in a future reasonableness review filing.

Pipeline Safety Enhancement Plan Final Report
Supply Line 30-18 Section 1 and 3 Replacement Project

B. Decision Tree Analysis

SoCalGas and SDG&E performed a PSEP Decision Tree analysis of Supply Line 30-18 and confirmed the project design should commence as a Replacement project.

Pipeline segments installed prior to 1946 that are not capable of being assessed using in-line inspection technology are identified for replacement under the approved PSEP Decision Tree. As explained in the testimony supporting the approved PSEP, as part of the work previously completed during implementation federal gas transmission pipeline integrity management regulations (49 CFR 192, Subpart O), SoCalGas and SDG&E have already identified, retrofitted and in-line inspected pre-1946 transmission pipelines that were constructed using acceptable welding techniques and are operationally suited to in-line inspection. The remaining pre-1946 segments in the SoCalGas/SDG&E system are not suited for in-line inspection, likely have non-state-of-the-art welds, and would require significant investment for retrofitting to accommodate in-line inspection tools. Accordingly, consistent with the Commission's directive in D.11-06-017 to "address retrofitting pipeline to allow for inline inspection tools," the requirement in California Public Utilities Code section 958 that upon completion of the PSEP, where warranted, pipelines are to be capable of accommodating in-line inspection devices, and the overarching objectives of PSEP to enhance the safety of the pipeline system in a proactive, cost effective manner, the approved PSEP Decision Tree identifies pre-1946 non-piggable pipeline segments for abandonment and/or replacement.

Pipeline Safety Enhancement Plan Final Report
Supply Line 30-18 Section 1 and 3 Replacement Project

Through this Decision Tree analysis, SoCalGas and SDG&E identified replacement as the more prudent option. Key considerations that support SoCalGas and SDG&E's determination to replace this segment include:

1. Shut-In Analysis: The Project Team completed a Request for Engineering Review (RER) analysis and concluded that the line could be shut-in and all impacted regulator stations that feed customers could be backfed from other pressure districts.
2. Customer Impacts: The Project Team identified the need for a new bypass to feed identified customers served from the southern portion of Supply Line 30-18 south of the shut-in extents, and compressed natural gas (CNG) to serve one customer located within the shut-in.
3. Community Impacts: Significant traffic impacts and occasional noise.
4. Permit Conditions: Multiple issues relating to traffic control, work times, moratoriums, and coordinating between multiple permitting agencies.
5. Piggability: Non-piggable.
6. Pipe Vintage: 1943.
7. Existing Pipe Attributes: Various attributes of the pipeline are unknown.
8. Longseam Type: Unknown.
9. Longseam Repair History: No identified issues.
10. Condition of Coating: No identified issues.
11. History of Leaks: No identified issues.

Pipeline Safety Enhancement Plan Final Report
Supply Line 30-18 Section 1 and 3 Replacement Project

C. Engineering, Design, and Planning Factors

SoCalGas and SDG&E reviewed pipeline drawings and other information, contacted internal planning groups, communicated with external stakeholders, conducted survey activities, including reviewing public records and potholing of the area to confirm the presence of underground utilities and substructures, and completed a pre-design site walk.

Replacement of Supply Line 30-18 required crossing of the Dominguez Channel and Caltrans Interstate 110 and Interstate 405 that would require extensive research, planning, and approval. This crossing was located in the middle of the replacement boundaries on Supply Line 30-18. The Project Team separated the replacement project into three sections to better manage and coordinate the replacement project with the respective permitting agencies.

Key factors that influenced the engineering and design of the Project are as follows:

Section 1

1. Customer Impacts: The Project Team planned to utilize regulator station valves and a pressure control fitting (PCF) to isolate from the mainline.
2. Community Impacts: The Project Team determined that a mobile home park situated within the construction area would require alternative access during construction.
3. Diameter Changes: The Project Team replaced the existing [REDACTED] line with a [REDACTED] line based on the recommendation of the RER. The additional cost to upsize the supply line was funded by the Operating District as discussed below in Section IV.

Pipeline Safety Enhancement Plan Final Report
Supply Line 30-18 Section 1 and 3 Replacement Project

4. Schedule Coordination: The other active Gardena Bundle projects (Supply Line 37-07, Supply Line 37-18, Supply Line 37-18-K and Supply Line 37-18-F) were coordinated in order to optimize use of the construction crews to minimize downtime and standby charges. The Project Team deployed crews to work on other Gardena Bundle projects between mobilizations.
5. Land Use: The Project Team planned to share the Broadway laydown yard that was acquired for the Gardena Bundle.
6. Valves: The Project Team planned to replace two existing MLVs with a single new piggable valve. The Project Team also designed a new valve at the west tie-in to aid with the isolation work for the planned Section 2 Replacement Project.
7. Tie-in: The Project Team designed the replacement on either side of the approximately 500 feet of Incidental pipe, resulting in a total of four planned tie-ins.
8. Constructability: The Project Team designed a jack and bore crossing at McKinley Channelview to comply with the Los Angeles County Department of Public Works permitting requirements prohibiting open cut trenching.

Section 2

During Engineering, Design, and Planning of the crossing of Dominguez Channel and Caltrans Interstate 110 and Interstate 405 it was apparent that the approval duration would result in significant delays to the construction start of the Project. As a result, the Project Team separated Section 2 from the remaining replacement work to better manage and execute the replacement work for the remaining segments of Category 4 Criteria pipe in a quicker manner.

Pipeline Safety Enhancement Plan Final Report
Supply Line 30-18 Section 1 and 3 Replacement Project

Section 3

1. Schedule Coordination:

- a. The Project Team originally planned the replacement of this section of Supply Line 30-18 as part of the scope of the Supply Line 37-18-F Hydrotest Project; however, to maintain service to customers, the Project was split into a separate replacement that was planned to occur after the completion of the Supply Line 37-18-F Hydrotest Project. The Project Team obtained additional information during the Supply Line 37-18-F Hydrotest Project that influenced the design of Section 3. As a result, the Supply Line 37-18-F Hydrotest Project included installation of a new valve and tap to support the Section 3 isolation requirements.
- b. The Project Team deferred replacement of 7 feet of Category 4 Criteria pipe on Supply Line 37-18-F to the Supply Line 30-18 Section 3 Replacement. This included removing the existing valve, replaced by the new valve from the Supply Line 37-18-F Hydrotest Project that was utilized for isolation.

2. Customer Impacts: The Project Team designed a bypass from the new tap on Supply Line 37-18-F to south of the tie-in for the Supply Line Section 3 Replacement Project to maintain service to customers. The Project Team planned to use a new PCF with bypass capability south of the Project and a [REDACTED] valve north of the Project to isolate the line. Temporary CNG was used for one customer location served just west of the isolation point north of the Project.

Pipeline Safety Enhancement Plan Final Report
Supply Line 30-18 Section 1 and 3 Replacement Project

3. System Analysis: The Project Team replaced the existing [REDACTED] and [REDACTED] line with a [REDACTED] line based on the recommendation of the RER. The additional cost to upsize the supply line was funded by the Operating District as discussed below in Section IV.
4. Land Use: The Project Team planned to share the laydown yard acquired for the other projects in the Gardena Bundle and utilize the workspace acquired for Supply Line 37-18-F Hydrotest Project.
5. Valves: The Project Team planned to replace the existing valve by installing two new [REDACTED] valves to improve piggability and isolation at this location.

Pipeline Safety Enhancement Plan Final Report
Supply Line 30-18 Section 1 and 3 Replacement Project

Figure 6: Prior to Construction of Supply Line 30-18 Section 3 Replacement Project Schematic

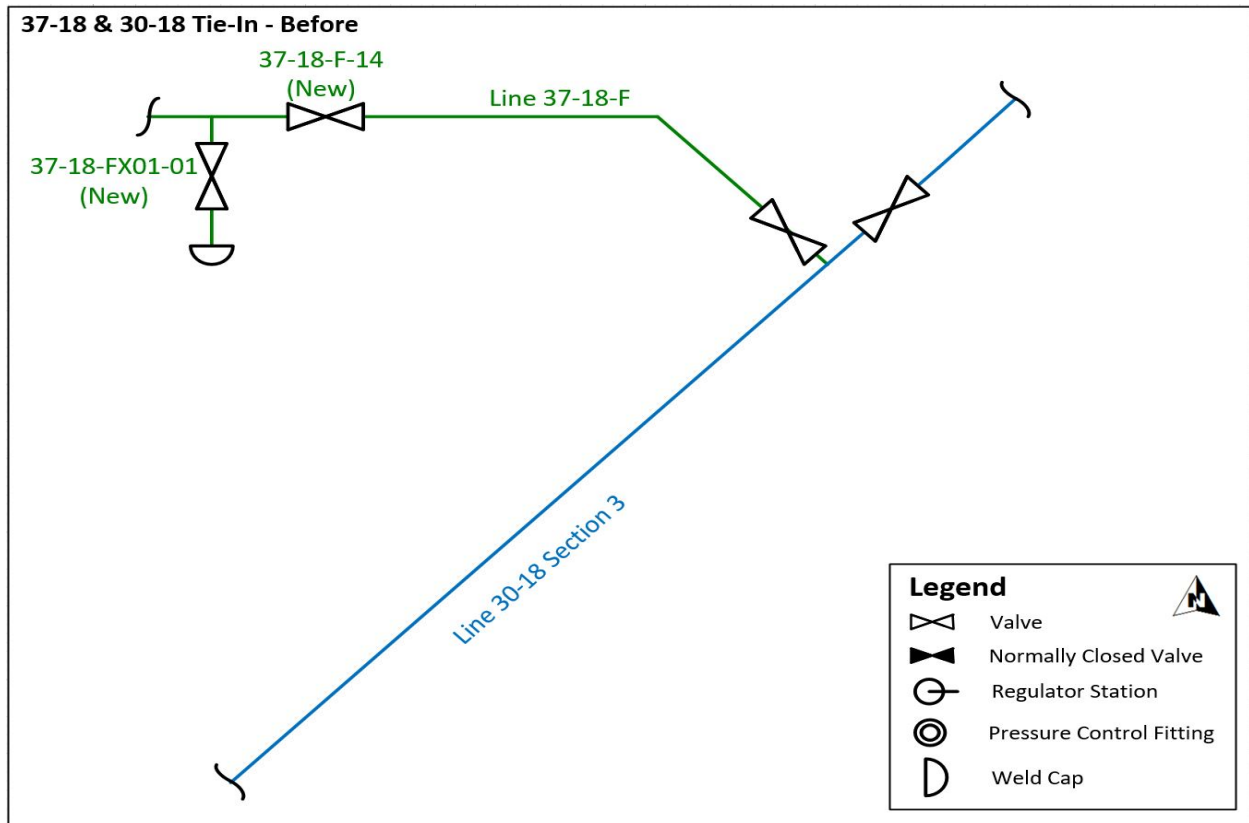

Pipeline Safety Enhancement Plan Final Report Supply Line 30-18 Section 1 and 3 Replacement Project

Figure 7: After Construction of Supply Line 30-18 Section 3 Replacement Project Schematic

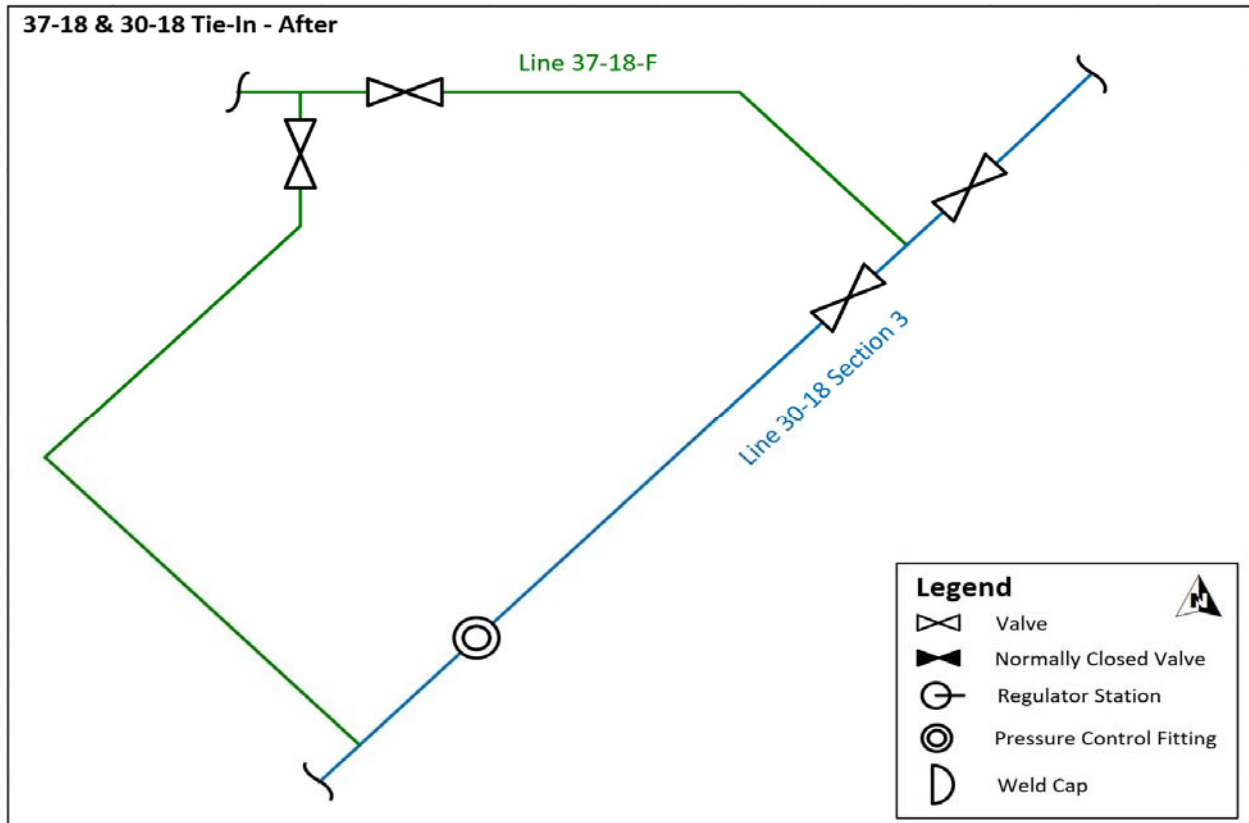

Pipeline Safety Enhancement Plan Final Report
Supply Line 30-18 Section 1 and 3 Replacement Project

D. Scope Changes

Through engineering, design, and planning activities, SoCalGas and SDG&E determined that changes in scope were appropriate to enhance the design of the Project and address engineering factors. As a result, the preliminary cost estimate does not fully reflect the final scope. Summarized below are notable changes in scope made after the preliminary cost estimate was developed and approved.

Section 1

1. Land Rights/Acquisition: SoCalGas and SDG&E were unable to obtain a permanent easement for the original design for the jack and bore crossing. As a result of negotiations with the land owner, the Project Team relocated one of the bore pits to an area just east of the original location, away from the driveway and entrance to the mobile home park.

Section 3

1. Permit Conditions:
 - a. The Project Team shortened the replacement length due to the inability to acquire a Caltrans excavation permit within schedule to coordinate with the Supply Line 37-18-F Hydrotest Project. The Project Team descope the remaining mileage from the replacement and included it with the Caltrans excavation permit application that was required for the Supply Line 30-18 Section 2 Replacement Project.
 - b. The Project Team extended permits from Supply Line 37-18-F Hydrotest Project.

Pipeline Safety Enhancement Plan Final Report
Supply Line 30-18 Section 1 and 3 Replacement Project

2. Constructability: The Project Team redesigned the bypass tap connection to a side tap off the pipeline. This removed the need for a PCF with bypass capabilities for the connection.

Pipeline Safety Enhancement Plan Final Report
Supply Line 30-18 Section 1 and 3 Replacement Project

III. CONSTRUCTION

A. Construction Contractor Selection

The Project Team prepared an initial cost estimate based on the preliminary design. Following completion of the engineering, design, and planning activities described above, the Project Team directed the Performance Partner to prepare cost estimates for Section 1 based on a more detailed engineering design package, that included the updated design described in the discussion of notable Scope Changes above. SoCalGas and SDG&E awarded the construction contract to the Performance Partner. For Section 3, the Project Team retained the Performance Partner to complete the additional work on Section 3 under a Time and Material contract, no estimate was completed.

1. SoCalGas and SDG&E’s Preliminary Construction Cost Estimate (confidential):
SoCalGas and SDG&E’s preliminary estimate for construction was [REDACTED].
2. Construction Contractor’s Target Price Estimate (confidential): The Construction Contractor’s cost estimate was [REDACTED], which was [REDACTED] than SoCalGas and SDG&E’s preliminary cost estimate for construction.

B. Construction Schedule

Table 3: Construction Timeline

Section 1	
Construction Start Date	07/14/2014
Construction Completion Date	02/12/2016
NOP Date	12/17/2015
Section 3	
Construction Start Date	10/31/2016
Construction Completion Date	12/20/2016
NOP Date	12/07/2016

Pipeline Safety Enhancement Plan Final Report
Supply Line 30-18 Section 1 and 3 Replacement Project

C. Changes During Construction

Section 1

The conditions summarized below were encountered during construction. Activities to address or mitigate these conditions resulted in approximately \$1,800,000 in change orders.

1. Tie-In: The Project Team determined it was more prudent to replace the additional 500 feet of Incidental pipe due to feasibility of open trench installation with minimal additional design or agency approval to increase piggability by creating a uniform diameter, and to reduce the construction impact for this location by removing the additional tie-ins and simplifying the hydrotest to a single test. This extended the project duration due to the unanticipated additional construction length.
2. Field Design Change: As discussed above, the jack and bore entry pit was originally located next to road access into the mobile home park. Due to delays in negotiations for an easement, the entry pit was relocated to an area that did not inhibit access to the mobile home park. The revised design required additional pipe with abrasion resistant overcoat due to the extended length of the jack and bore crossing, engineered shoring for the bore pits, and the removal of trees in conflict with the planned bore locations.
3. Water Management: During excavation of the bore pits, the Construction Contractor encountered groundwater. This resulted in costs for dewatering, transporting, and disposing of the groundwater from the bore pits. The Project Team treated and stored the groundwater in tanks at a vendor's facility and then utilized the water for the hydrotest. The Project Team also reused some of the water for Supply Line 37-07 Replacement Project and Supply Line 44-137 Replacement Projects for their hydrotests. The water that was not reused was transported to a disposal facility.

Pipeline Safety Enhancement Plan Final Report
Supply Line 30-18 Section 1 and 3 Replacement Project

4. Constructability Issues: The Construction Contractor required an additional six feet depth for sufficient clearance and a deeper excavation at the intersection of Victoria Street and Central Avenue to allow for enough clearance for the planned test head location.
5. Schedule Delay: Unplanned delays extended the Project and additional field support costs were incurred to support the completion of this project.
 - a. The Construction Contractor completed pipelay for Supply Line 30-18 Replacement and was instructed to remain on standby until the start of Supply Line 37-07 Replacement. Demobilizing and remobilizing the Construction Contractor for the duration between the two projects would have been more costly and potentially delay the start of the Supply Line 37-07 Replacement Project.
 - b. During the tie-in operations, changes to SoCalGas and SDG&E inspection criteria resulted in an extended tie-in duration to meet the inspection criteria.
 - c. The City of Carson allowed extending the planned work hours so that the Construction Contractor could accelerate the work schedule.
6. Environmental Abatement: During excavation, the Construction Contractor encountered asbestos debris in the trench excavation that halted construction activities until it was removed. The Construction Contractor was on standby until the abatement crew could remove the asbestos debris in the trench.
7. Customer Impact Mitigation: The Project Team required a new PCF with bypass capability to tie-in lateral Line 30-18-D in addition to utilizing an existing PCF to backfeed during the isolation.

Pipeline Safety Enhancement Plan Final Report
Supply Line 30-18 Section 1 and 3 Replacement Project

Section 3

The conditions summarized below were encountered during construction. Activities to address or mitigate these conditions resulted in approximately \$150,000 in change orders.

1. Traffic: To improve safety, the Construction Contractor was required to utilize additional traffic control for the freeway off-ramp.
2. Field Design Change: Due to close proximity of the tie-in excavation and two intersecting trenches, the Construction Contractor required additional plates and shoring for the tie-in in excess of what was planned for by the Project Team.
3. Tie-in: Through the information obtained from the Supply Line 37-18-F Hydrotest Project, the Project Team determined there was an existing substructure that would affect the tie-in. The construction of the additional wedding bands for the tie-in extended the planned duration.

Pipeline Safety Enhancement Plan Final Report
Supply Line 30-18 Section 1 and 3 Replacement Project

D. Commissioning and Site Restoration

Commissioning activities include restoration of the site, final inspection and placement of the pipeline back into service, transportation and disposal of hydrotested water and hazardous material, and site demobilization. Closeout activities include development of final drawings, finalization of a reconciliation package, and updates to company recordkeeping systems to reflect the completed scope of work.

Pipeline Safety Enhancement Plan Final Report
Supply Line 30-18 Section 1 and 3 Replacement Project

IV. PROJECT COSTS

A. Cost Avoidance Actions

SoCalGas and SDG&E exercised due diligence in the planning, design, and construction activities for this project to minimize or avoid costs when prudent to do so. As discussed above, the Project Team conducted a site visit to identify and incorporate discernible site conditions into the engineering, design, and planning of the Project. Specific examples of cost avoidance actions taken on this project are:

1. Materials: Bulk order pipe provided volume pricing for the [REDACTED] pipe.
2. Land Use: The laydown yard was shared with other projects in the Gardena Bundle that reduced the mobilization and demobilization costs for this project.
3. Water Management: Some of the groundwater removed from the bore pits was treated and utilized for this project along with the Supply Line 37-07 Replacement Project and Supply Line 44-137 Replacement Project, reducing costs of water acquisition.
4. Permit Conditions: Descoping some of the replacement pipe within Section 3 and transferring the pipe to Section 2, along with extending the duration of the permits from the Supply Line 37-18-F Hydrotest Project, reduced the required permitting effort for Section 3.
5. Engineering and Design: Removing the additional PCF for the bypass connection reduced the cost of materials and support costs for the installation of the PCF.

Pipeline Safety Enhancement Plan Final Report
Supply Line 30-18 Section 1 and 3 Replacement Project

B. Cost Estimate

Based on the preliminary design, once the project scope was confirmed and engineering, design, and planning activities were underway, SoCalGas and SDG&E prepared an estimate of the Direct Costs of the Project in the amount of \$18,771,668. This estimate was prepared in April of 2014, using the “SCG Pipeline Estimate Template Rev 0” estimating tool, the most current version of the PSEP Estimate Template at the time. The Project Team considered the conditions known at the time to prepare the preliminary Direct Cost estimate. This estimate reflects the projected Labor, Material, and Services costs anticipated to be incurred to execute the Project.

SoCalGas and SDG&E estimated Indirect Costs of the Project based on the estimated Direct Costs and other project-related variables.

C. Actual Direct and Indirect Costs

Actual Direct Costs reflect the Labor, Material, and Service costs incurred to execute the Project. Actual Indirect Costs reflect costs for incremental overhead loaders in accordance with Company overhead allocation policies. The total loaded cost of the Project is \$28,281,200.

The total costs for this project include a credit provided by the Operating District to fund the cost difference associated with the change in pipeline diameter. The Project Team completed a comparative cost estimate during the preliminary design cost estimate of the two diameters to calculate the incremental cost difference associated with the change in pipeline diameter.

Pipeline Safety Enhancement Plan Final Report
Supply Line 30-18 Section 1 and 3 Replacement Project

Table 4: Estimated and Actual Direct Costs and Variances

Direct Costs (\$)	Estimate	Actuals ⁸	Delta Over/(Under)
Company Labor	468,337	410,407	(57,930)
Materials	2,470,799	1,106,371	(1,364,428)
Construction Contractor	9,425,596	9,981,229	555,633
Construction Management & Support	1,423,125	1,717,942	294,817
Environmental	187,836	1,328,913	1,141,077
Engineering & Design	1,577,995	2,735,298	1,157,303
Project Management & Services	1,124,789	3,089,557	1,964,768
ROW & Permits	96,360	663,009	566,649
GMA	1,996,831	2,736,139	739,308
Total Direct Costs	18,771,668	23,768,865	4,997,197

Table 5: Estimated and Actual Indirect Costs, Total Costs, and Variances

Indirect Costs/Total Costs (\$)	Estimate	Actuals	Delta Over/(Under)
Overheads	6,961,212	2,235,503	(4,725,709)
AFUDC	2,550,334	2,026,187	(524,147)
Property Taxes	499,255	250,645	(248,610)
Total Indirect Costs	10,010,801	4,512,335	(5,498,466)
Total Direct Costs	18,771,668	23,768,865	4,997,197
Total Loaded Costs	28,782,469	28,281,200	(501,269)

⁸ Actual Material and Construction Contractor costs exclude the cost of upsizing the pipe.

Pipeline Safety Enhancement Plan Final Report
Supply Line 30-18 Section 1 and 3 Replacement Project

D. Disallowance

There was no disallowance for Supply Line 30-18 Sections 1 and 3 as there were no post-1955 segments included in the Project without records that provide the minimum information to demonstrate compliance with then applicable industry standards or regulatory strength testing and recordkeeping requirements.

Pipeline Safety Enhancement Plan Final Report
Supply Line 30-18 Section 1 and 3 Replacement Project

V. CONCLUSION

SoCalGas and SDG&E enhanced the safety of their integrated natural gas transmission system by prudently executing the Supply Line 30-18 Section 1 and 3 Replacement Projects. Through these Replacement Projects, SoCalGas and SDG&E successfully replaced 2.011 miles of pipe and installed four new MLVs in the Cities of Carson and Los Angeles, and Los Angeles County. The total loaded cost of the Project is \$28,281,200.

SoCalGas and SDG&E executed this project prudently by increasing the pigability of the pipeline, utilizing bulk ordered materials, sharing a laydown yard across several projects within the Gardena Bundle, and splitting the Project into sections to replace the pipeline as quickly and prudently as possible.

SoCalGas and SDG&E engaged in prudent cost avoidance efforts by utilizing water encountered during excavation for the hydrotest of multiple projects and coordinating construction activities with five other projects to optimize the efficiency of the construction crews and minimize downtime and standby charges.

End of Supply Line 30-18 Section 1 and 3 Replacement Project Final Report

Pipeline Enhancement Safety Plan Final Report
Supply Line 33-120 Section 3 Replacement Project

I. SUPPLY LINE 33-120 SECTION 3 REPLACEMENT PROJECT

A. Background and Summary

Supply Line 33-120 is a predominantly [REDACTED] diameter transmission line that runs approximately 13 miles from Sylmar to Encino. The pipeline is primarily routed across a Class 3 location, and traverses some Class 1 and Class 2 locations. The specific attributes of this Project are detailed in Table 1 below. This report describes the activities associated with the Supply Line 33-120 Replacement Project that consists of the replacement of 0.516 miles of pipeline with a span crossing the Los Angeles River and the installation of one mainline valve (MLV) and bridle assembly. The specific attributes of this Project are detailed in Table 1 below. The total loaded cost of the Project is \$7,439,840.

Table 1: General Project Information

Project Name		Supply Line 33-120		
Project Type	Replacement			
Length	0.516 mile			
Location	Los Angeles			
Class	3			
MAOP (<i>confidential</i>)	[REDACTED]			
Pipe Vintage	1940			
Construction Start	06/19/2017			
Construction Finish	09/20/2017			
Original Pipe Diameter (<i>confidential</i>)	[REDACTED]			
New Diameter (<i>confidential</i>)	[REDACTED]			
Original SMYS ¹ (<i>confidential</i>)	[REDACTED]			
New SMYS (<i>confidential</i>)	[REDACTED]			
Project Costs (\$)	Capital	O&M	Total	
Loaded Project Costs	7,320,162	119,678	7,439,840	
Disallowed Costs	-	-	-	

¹ Highest percentage of Specified Minimum Yield Strength (SMYS) of Category 4 Criteria pipe.

Pipeline Enhancement Safety Plan Final Report
Supply Line 33-120 Section 3 Replacement Project

B. Maps and Images

Figure 1: Satellite Image of Supply Line 33-120 Section 3 Replacement Project



Pipeline Enhancement Safety Plan Final Report Supply Line 33-120 Section 3 Replacement Project

Figure 2: Overview Map of Supply Line 33-120 Section 3 Replacement Project

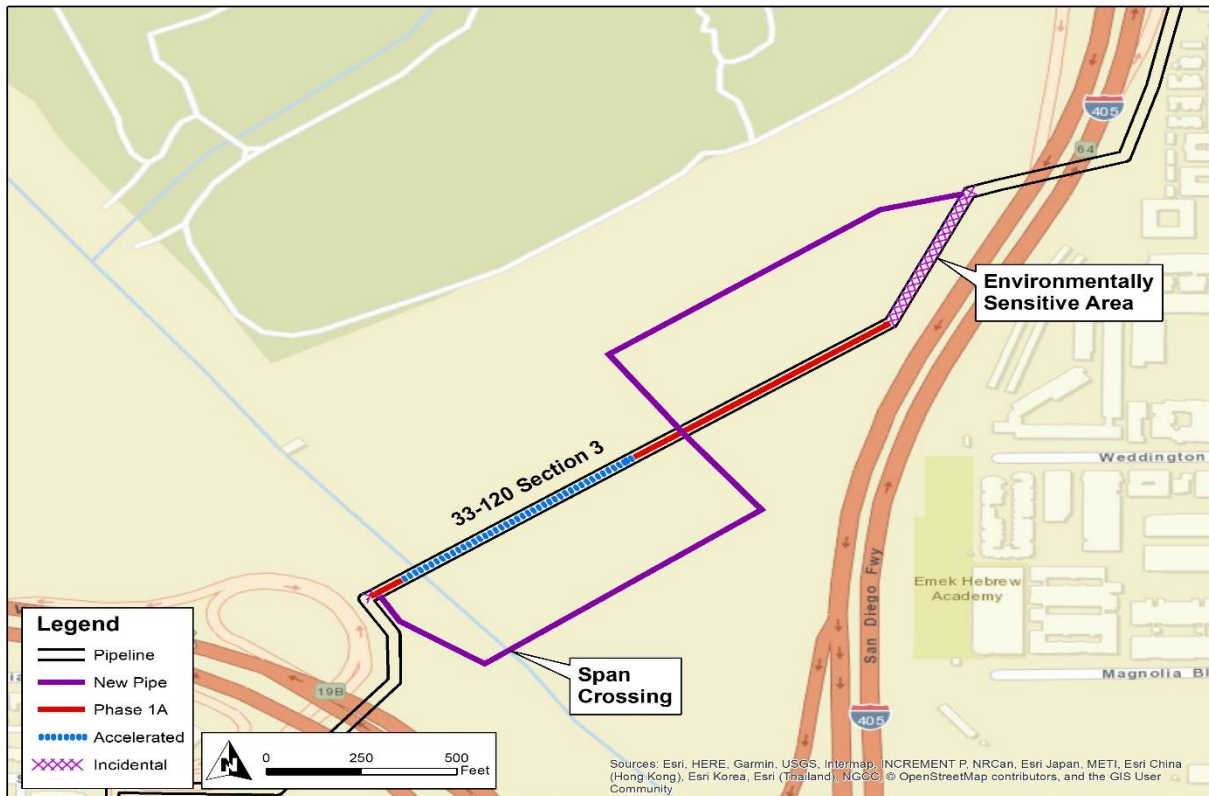

Pipeline Enhancement Safety Plan Final Report
Supply Line 33-120 Section 3 Replacement Project

II. ENGINEERING, DESIGN, AND PLANNING

A. Project Scope

Table 2: Mileage Information

	Criteria	Accelerated ²	Incidental	New	Total ³
Final Mileage	0.144 mi.	0.110 mi.	0.085 mi.	0.177 mi.	0.516 mi.
	761 ft.	583 ft.	448 ft.	933 ft.	2,725 ft.

SoCalGas and SDG&E presented a conceptual project scope in workpapers supporting the 2011 PSEP filing.⁴ Prior to initiating execution of the Project in 2017, SoCalGas and SDG&E reviewed existing pipeline records to validate the scope of the Project. During the Engineering, Design, and Planning phase, SoCalGas and SDG&E further refined the scope. The progression of project scope is summarized as follows:

1. 2011 PSEP Filing: SoCalGas and SDG&E identified Supply Line 33-120 as a Phase 1A Replacement Project comprised of 0.387 miles Category 4 Criteria pipe and 0.865 miles of Accelerated pipe.
2. Scope Validation: Through scope validation activities, after the 2011 filing and before initiating execution of the Project, SoCalGas and SDG&E verified the scope of the Project.

² Accelerated mileage includes Phase 1B pipe. The Accelerated mileage was included to realize efficiencies and to enhance project constructability.

³ Values may not add to total due to rounding.

⁴ See Amended PSEP of SoCalGas and SDG&E, submitted December 2, 2011, in R.11-02-019 and subsequently transferred to A.11-11-002.

Pipeline Enhancement Safety Plan Final Report
Supply Line 33-120 Section 3 Replacement Project

3. Engineering, Design, and Constructability:
 - a. Based on the non-contiguous location of the Category 4 Criteria pipe, the Project Team planned execution of the Supply Line 33-120 Replacement Project in three sections.⁵
 - b. Section 3 consists of 761 feet of Category 4 Criteria pipe and 0.110 miles of Accelerated Phase 1B pipe and 448 feet of Incidental pipe.
 - c. The Project Team included Accelerated pipe due to similar permitting requirements and included Incidental pipe for tie-in locations extending beyond the limits of the Category 4 Criteria pipe.
4. Final Project Scope: The final project scope consists of a 0.516 mile Replacement. The Accelerated mileage consists of 583 feet of Phase 1B pipe.

B. Decision Tree Analysis

SoCalGas and SDG&E performed a PSEP Decision Tree analysis of Supply Line 33-120 Section 3 and confirmed the project design should commence as a Replacement project.

Pipeline segments installed prior to 1946 that are not capable of being assessed using in-line inspection technology are identified for replacement under the approved PSEP Decision Tree. As explained in the testimony supporting the approved PSEP, as part of the work previously completed during implementation federal gas transmission pipeline integrity management regulations (49 CFR 192, Subpart O), SoCalGas and SDG&E have already identified, retrofitted and in-line inspected pre-1946 transmission pipelines that were constructed using acceptable welding techniques and are operationally suited to in-line inspection.

⁵ Section 2 was filled for recovery in A.16-09-005, Section 1 will be filled for recovery in a future filling.

Pipeline Enhancement Safety Plan Final Report
Supply Line 33-120 Section 3 Replacement Project

The remaining pre-1946 segments in the SoCalGas/SDG&E system are not suited for in-line inspection, likely have non-state-of-the-art welds, and would require significant investment for retrofitting to accommodate in-line inspection tools. Accordingly, consistent with the Commission’s directive in D.11-06-017 to “address retrofitting pipeline to allow for inline inspection tools,” the requirement in California Public Utilities Code section 958 that upon completion of the PSEP, where warranted, pipelines are to be capable of accommodating in-line inspection devices, and the overarching objectives of PSEP to enhance the safety of the pipeline system in a proactive, cost effective manner, the approved PSEP Decision Tree identifies pre-1946 non-piggable pipeline segments for abandonment and/or replacement.

Through this Decision Tree analysis, SoCalGas and SDG&E identified replacement as the more prudent option. Key considerations that support SoCalGas and SDG&E’s determination to replace this segment include:

1. Shut-In Analysis: The Project Team completed a Request for Engineering Review (RER) analysis and concluded that the line could be shut-in.
2. Customer Impacts: There would be no anticipated customer impact during a shut-in.
3. Permit Conditions: The entire pipeline replacement is located on United States Army Corps of Engineers (USACE) property and subject to a conditional permit approval.
4. Piggability: Non-piggable.
5. Pipe Vintage: 1940.
6. Existing Pipe Attributes: No identified issues.
7. Longseam Type: Unknown.

Pipeline Enhancement Safety Plan Final Report
Supply Line 33-120 Section 3 Replacement Project

8. Longseam Repair History: No identified issues.
9. Condition of Coating: No identified issues.
10. History of Leaks: No identified issues.

C. Engineering, Design, and Planning Factors

SoCalGas and SDG&E reviewed pipeline drawings and other information, contacted internal planning groups, communicated with external stakeholders, conducted survey activities, including reviewing public records and potholing of the area to confirm the presence of underground utilities and substructures, and completed a pre-design site walk. Key factors that influenced the engineering and design of the Project are as follows:

1. Shut-In Analysis: As discussed above, the Project Team completed an RER analysis and concluded the line could be shut-in. The Project Team planned to use MLVs for shut-in with stopples as a contingency plan.
2. Diameter Changes: The Project Team replaced the existing [REDACTED] line with a [REDACTED] line based on the recommendation of the RER and to standardize the pipeline for future pigging purposes.
3. Land Use: The Project Team acquired a laydown yard and a worksite within the Sepulveda Dam area immediately adjacent to the project site. The new pipeline alignment required that the U.S. Army Corp of Engineers (USACE) grant an easement that added to USACE's discretionary actions.

Pipeline Enhancement Safety Plan Final Report
Supply Line 33-120 Section 3 Replacement Project

4. Permit Conditions: The Project Team pushed out the start of construction due to delays with the USACE permit.
 - a. Originally, USACE gave the Project Team a two month construction time frame due to environmental concerns. After several years of negotiation, the Project Team finally received a permit from USACE to proceed.
5. Environmental: The Project Team identified that sections of the existing pipe were located in environmentally sensitive areas, such as the Los Angeles River channel and riverine drainage feature. The Project Team required several permits, such as a Storm Water Pollution Prevention Plan (SWPPP) and a Clean Water Act (CWA) Section 401 permit.
6. Reroute: The existing alignment crossed beneath the Sepulveda Dam spillway. The Project Team analyzed several alternatives to crossing the dam and the Los Angeles River. The final design included an approximately 50 foot span crossing across the Los Angeles River at the base of the Sepulveda Dam. As required by the USACE, the design of the span crossing required engineering of supports to avoid impacting the concrete channel walls.
7. Valves: The Project Team designed a replacement for an existing MLV with a new bridle and blow-off connection.

D. Scope Changes

SoCalGas and SDG&E did not make any notable scope changes during detailed design.

Pipeline Enhancement Safety Plan Final Report
Supply Line 33-120 Section 3 Replacement Project

III. CONSTRUCTION

A. Construction Contractor Selection

The Project Team prepared an initial cost estimate based on the preliminary design. Following completion of the engineering, design, and planning activities described above, the Project Team directed the Performance Partner to prepare cost estimates based on a more detailed engineering design package. As indicated above, there were no notable changes in scope between the time when the Project Team prepared the preliminary cost estimate and when the Performance Partner prepared and submitted its Target Price Estimate. SoCalGas and SDG&E awarded the construction contract to the Performance Partner.

1. SoCalGas and SDG&E's Preliminary Construction Cost Estimate (*confidential*):
SoCalGas and SDG&E's preliminary estimate for construction was [REDACTED].
2. Construction Contractor's Target Price Estimate (*confidential*): The Construction Contractor's cost estimate was [REDACTED], which was [REDACTED] than SoCalGas and SDG&E's preliminary cost estimate for construction.

B. Construction Schedule

Table 3: Construction Timeline

Construction Start Date	06/19/2017
Construction Completion Date	09/20/2017
NOP Date	08/28/2017

C. Changes During Construction

SoCalGas and SDG&E successfully mitigated conditions during construction in a manner that minimized potential impacts on project scope, cost, and schedule. As a result, these conditions did not result in any notable change orders.

Pipeline Enhancement Safety Plan Final Report
Supply Line 33-120 Section 3 Replacement Project

Figure 3: Span Crossing of Abandoned Bypass



Pipeline Enhancement Safety Plan Final Report
Supply Line 33-120 Section 3 Replacement Project

Figure 4: Span Crossing of Replacement Pipeline



Pipeline Enhancement Safety Plan Final Report
Supply Line 33-120 Section 3 Replacement Project

Figure 5: Open Trench Installation of Replacement Pipeline



Pipeline Enhancement Safety Plan Final Report Supply Line 33-120 Section 3 Replacement Project

Figure 6: Pressure Control Fitting Isolation Machine



Pipeline Enhancement Safety Plan Final Report
Supply Line 33-120 Section 3 Replacement Project

D. Commissioning and Site Restoration

Commissioning activities include restoration of the site, final inspection and placement of the pipeline back into service, transportation and disposal of hydrotested water and hazardous material, and site demobilization. Closeout activities include development of final drawings, finalization of a reconciliation package, and updates to company recordkeeping systems to reflect the completed scope of work.

Pipeline Enhancement Safety Plan Final Report
Supply Line 33-120 Section 3 Replacement Project

IV. PROJECT COSTS

A. Cost Avoidance Actions

SoCalGas and SDG&E exercised due diligence in the planning, design, and construction activities for this project to minimize or avoid costs when prudent to do so. As discussed above, the Project Team conducted a site visit to identify and incorporate discernible site conditions into the engineering, design, and planning of the Project. Specific examples of cost avoidance actions taken on this project are:

1. Materials: Bulk ordered pipe provided volume pricing for the [REDACTED] pipe.
2. Land Use: All materials were stored within the yard located adjacent to the Project so there was no need to coordinate multiple areas and material handling was kept to a minimum.
3. Permit Conditions: Negotiations with USACE removed the compressed two month construction time frame, reducing overtime requirements for the Construction Contractor to complete construction. This also eliminated the possibility of having to demobilize the Project in the event construction was not completed in time.
4. Engineering and Design: The Project Team and the Construction Contractor agreed to remove the existing abandoned [REDACTED] line and utilize the same trench to install the new [REDACTED] line instead of digging a second trench. This lead to a reduction in the construction cost.

Pipeline Enhancement Safety Plan Final Report
Supply Line 33-120 Section 3 Replacement Project

B. Cost Estimate

Based on the preliminary design, once the project scope was confirmed and engineering, design, and planning activities were underway, SoCalGas and SDG&E prepared an estimate of the Direct Costs of the Project in the amount of \$7,783,306. This estimate was prepared in December of 2015, using the “SCG Pipeline Estimate Template Rev 3” estimating tool, the most current version of the PSEP Estimate Template at the time. The Project Team considered the conditions known at the time to prepare the preliminary Direct Cost estimate. This estimate reflects the projected Labor, Material, and Services costs anticipated to be incurred to execute the Project.

SoCalGas and SDG&E estimated Indirect Costs of the Project based on the estimated Direct Costs and other project-related variables.

C. Actual Direct and Indirect Costs

Actual Direct Costs reflect the Labor, Material, and Service costs incurred to execute the Project. Actual Indirect Costs reflect costs for incremental overhead loaders in accordance with Company overhead allocation policies. The total loaded cost of the Project is \$7,439,840.

Pipeline Enhancement Safety Plan Final Report
Supply Line 33-120 Section 3 Replacement Project

Table 4: Estimated and Actual Direct Costs and Variances

Direct Costs (\$)	Estimate	Actuals	Delta Over/(Under)
Company Labor	312,555	230,714	(81,841)
Materials	1,013,126	461,359	(551,767)
Construction Contractor	3,096,971	2,247,095	(849,876)
Construction Management & Support	519,817	489,187	(30,630)
Environmental	379,500	499,771	120,271
Engineering & Design	584,775	1,443,252	858,477
Project Management & Services	784,418	333,220	(451,198)
ROW & Permits	301,652	82,699	(218,953)
GMA	790,492	750,615	(39,877)
Total Direct Costs	7,783,306	6,537,912	(1,245,394)

Table 5: Estimated and Actual Indirect Costs, Total Costs, and Variances

Indirect Costs/Total Costs (\$)	Estimate	Actuals	Delta Over/(Under)
Overheads	629,703	546,158	(83,545)
AFUDC	1,612,094	314,421	(1,297,673)
Property Taxes	343,141	41,349	(301,792)
Total Indirect Costs	2,584,938	901,928	(1,683,010)
Total Direct Costs	7,783,306	6,537,912	(1,245,394)
Total Loaded Costs	10,368,244	7,439,840	(2,928,404)

D. Disallowance

There was no disallowance for Supply Line 33-120 Section 3 as there were no post-1955 segments included in the Project without records that provide the minimum information to demonstrate compliance with then applicable industry standards or regulatory strength testing and recordkeeping requirements.

Pipeline Enhancement Safety Plan Final Report
Supply Line 33-120 Section 3 Replacement Project

V. CONCLUSION

SoCalGas and SDG&E enhanced the safety of their integrated natural gas transmission system by prudently executing the Supply Line 33-120 Section 3 Replacement Project. Through this Replacement Project, SoCalGas and SDG&E successfully replaced 0.516 miles of pipe in the City of Los Angeles. The total loaded cost of the Project is \$7,439,840.

SoCalGas and SDG&E executed this project prudently by analyzing reroute alternatives to select the most appropriate replacement alignment and negotiated with permitting agencies for better construction duration.

SoCalGas and SDG&E engaged in prudent cost avoidance efforts by bulk ordering material, acquiring and utilizing a laydown yard within the immediate vicinity of the construction site, and working with the Construction Contractor for reduced excavation and installation costs of the new pipeline.

End of Supply Line 33-120 Replacement Project Final Report

Pipeline Enhancement Safety Plan Final Report
Final Report for Supply Line 36-1002 Replacement Project

I. SUPPLY LINE 36-1002 REPLACEMENT PROJECT

A. Background and Summary

Supply Line 36-1002 is a [REDACTED] diameter transmission line within the SoCalGas and SDG&E operated Gaviota Regulator Station in an industrial area along Highway 1 that runs approximately 20 miles from the City of Goleta to Gaviota. The pipeline is primarily routed across a Class 1 location and traverses some Class 3 locations. This report describes the activities associated with the Supply Line 36-1002 Replacement Project that consist of the replacement of 178 feet of pipeline and two connections to existing aboveground piping within the station. The specific attributes of this Project are detailed in Table 1 below. The total loaded cost of the Project is \$2,035,491.

Table 1: General Project Information

Project Name	Supply Line 36-1002		
Project Type	Replacement		
Length	178 feet		
Location	Goleta		
Class	3		
MAOP (<i>confidential</i>)	[REDACTED]		
Pipe Vintage	1928		
Construction Start	06/01/2015		
Construction Finish	08/14/2015		
Original Pipe Diameter (<i>confidential</i>)	[REDACTED]		
New Diameter (<i>confidential</i>)	[REDACTED]		
Original SMYS ¹ (<i>confidential</i>)	[REDACTED]		
New SMYS (<i>confidential</i>)	[REDACTED]		
Project Costs (\$)	Capital	O&M	Total
Loaded Project Costs	2,035,373	118	2,035,491
Disallowed Costs	-	-	-

¹ Highest percentage of Specified Minimum Yield Strength (SMYS) of Category 4 Criteria pipe.

Pipeline Enhancement Safety Plan Final Report
Final Report for Supply Line 36-1002 Replacement Project

B. Maps and Images

Figure 1: Satellite Image of Supply Line 36-1002 Replacement Project

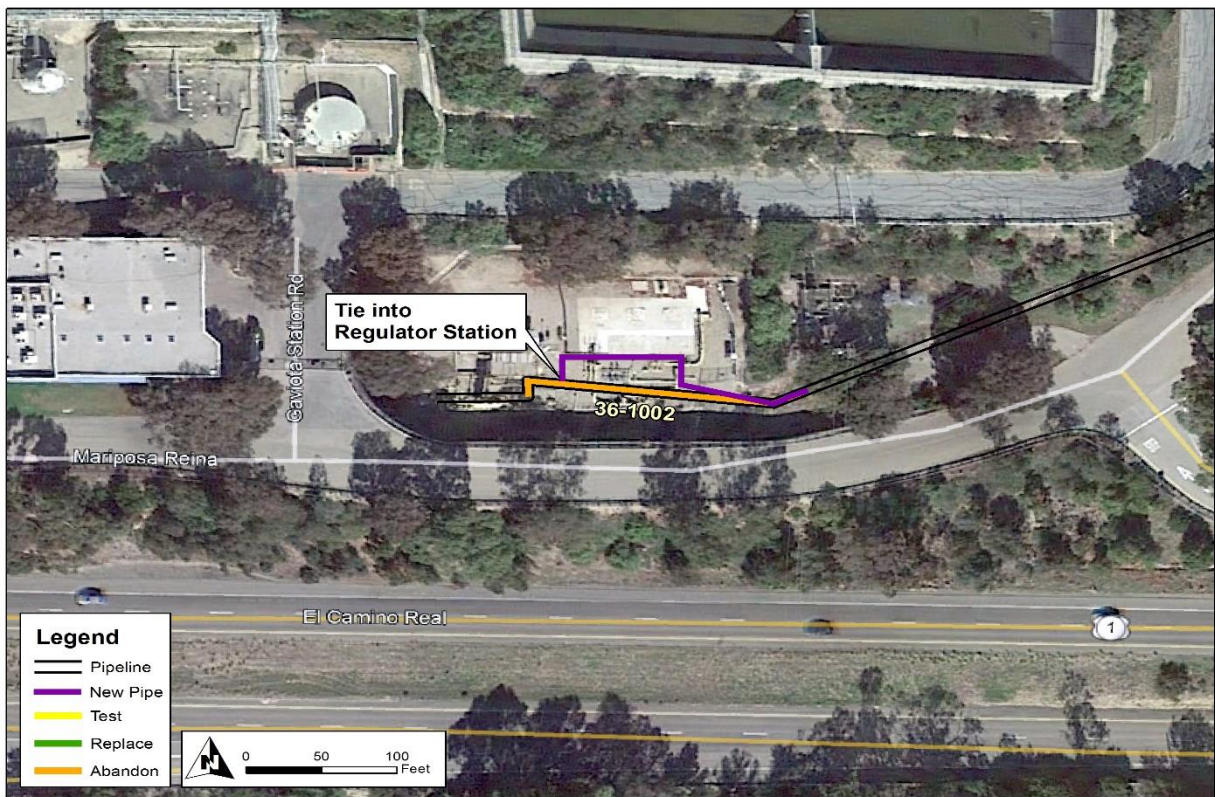

Pipeline Enhancement Safety Plan Final Report
Final Report for Supply Line 36-1002 Replacement Project

Figure 2: Overview Map of Supply Line 36-1002 Replacement Project

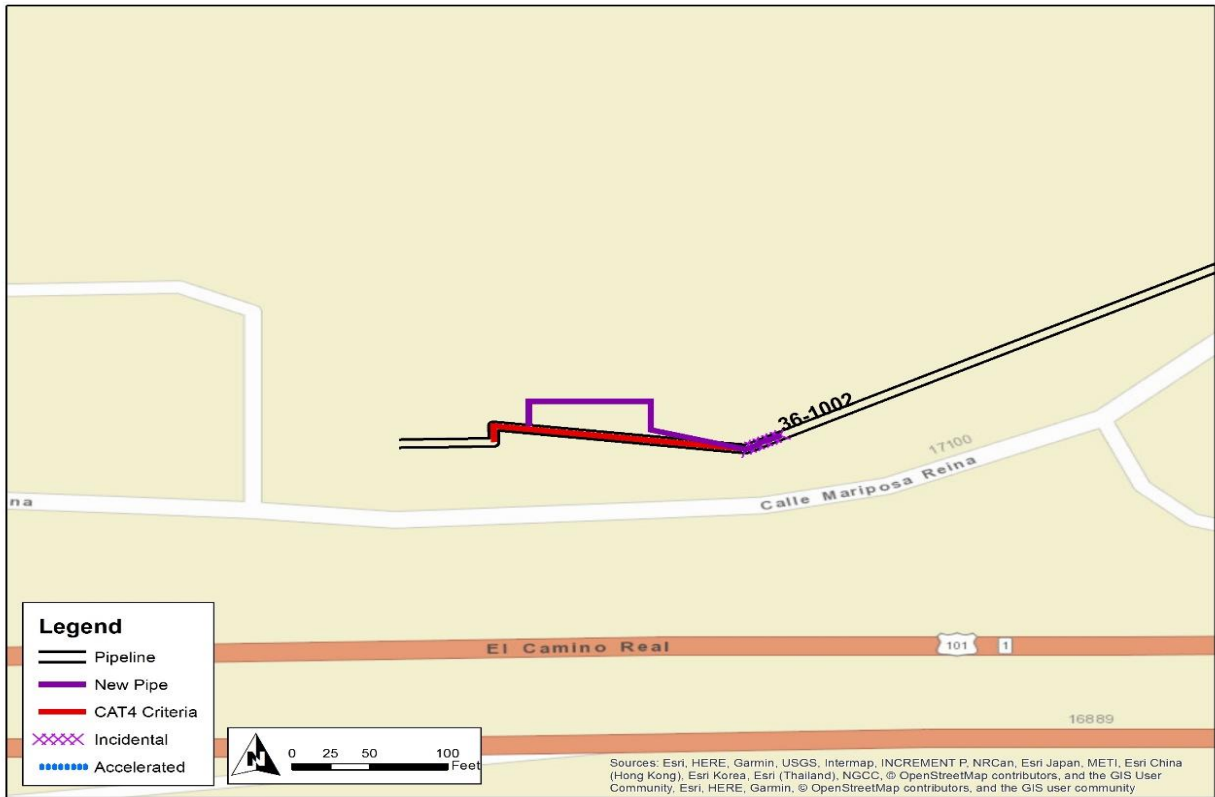

Pipeline Enhancement Safety Plan Final Report
Final Report for Supply Line 36-1002 Replacement Project

Figure 3: Schematic of Supply Line 36-1002 Replacement Project

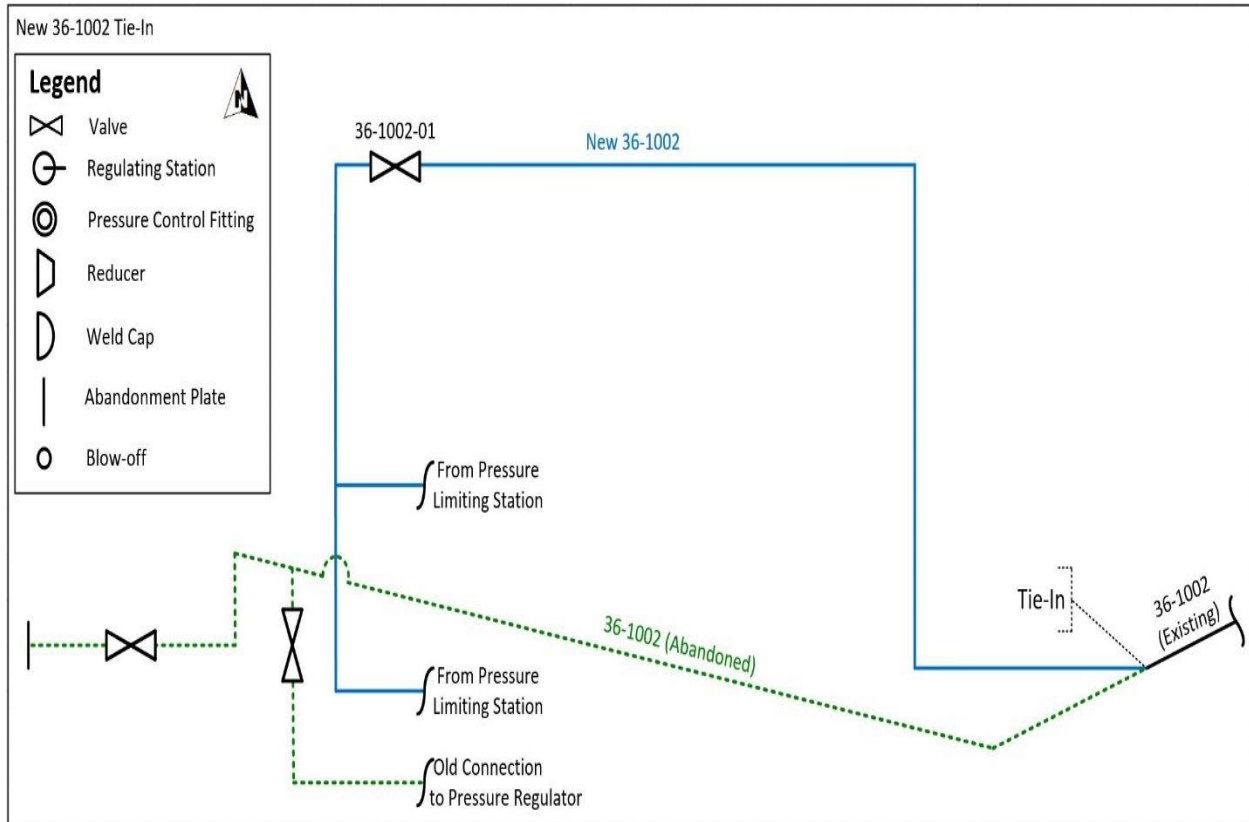

Pipeline Enhancement Safety Plan Final Report
Final Report for Supply Line 36-1002 Replacement Project

II. ENGINEERING, DESIGN, AND PLANNING

A. Project Scope

Table 2: Mileage Information

	Criteria	Accelerated	Incidental	New	Total ²
Final Mileage	0.023 mi.	0 mi.	0.004 mi.	0.007 mi.	0.034 mi.
	120 ft.	0 ft.	20 ft.	38 ft.	178 ft.

SoCalGas and SDG&E presented a conceptual project scope in workpapers supporting the 2011 PSEP filing.³ Prior to initiating execution of the Project in 2015, SoCalGas and SDG&E reviewed existing pipeline records to validate the scope of the Project. During the Engineering, Design, and Planning phase, SoCalGas and SDG&E further refined the scope. This progression of the project scope is summarized as follows:

1. 2011 PSEP Filing: SoCalGas and SDG&E identified Supply Line 36-1002 as a Phase 1A Replacement Project comprised of 375 feet of Category 4 Criteria pipe and 729 feet of Accelerated pipe.
2. Scope Validation: Through scope validation activities, after the 2011 filing and before initiation of the Project, SoCalGas and SDG&E confirmed final scope of the Project to be 120 feet of Category 4 Criteria pipe. The descoped pipeline footage operates below 20% SMYS, and therefore, does not fall within the scope of PSEP.

² Values may not add to total due to rounding.

³ See Amended PSEP of SoCalGas and SDG&E, submitted December 2, 2011, in R.11-02-019 and subsequently transferred to A.11-11-002.

Pipeline Enhancement Safety Plan Final Report
Final Report for Supply Line 36-1002 Replacement Project

3. Engineering, Design, and Constructability: Based on the presence of other existing piping and pipelines within the Gaviota Regulator Station, SoCalGas and SDG&E rerouted the initial replacement design. This increased the installation length to 178 feet. Incidental mileage increased by 20 feet because of the need to reroute the alignment.
4. Final Project Scope: The final project scope consists of a 178 foot Replacement. The Incidental mileage consists of 20 feet of pipe.

B. Decision Tree Analysis

SoCalGas and SDG&E performed a PSEP Decision Tree analysis of Supply Line 36-1002 and confirmed the project design should commence as a Replacement Project.

Segments of less than 1,000 feet are identified for replacement under the approved PSEP Decision Tree because, for short segments of pipe, the logistical costs associated with pressure testing (for example, permitting, construction, water handling, and service disruptions for a non-looped system) can approach or exceed the cost of replacement. In such circumstances, replacement affords a more cost-effective approach to achieving compliance with D.11-06-017 while providing equal safety enhancement benefits. Moreover, installation of the new segment can usually be performed while the existing service is maintained to customers, thereby avoiding service disruptions that may otherwise occur during pressure testing.

Pipeline Enhancement Safety Plan Final Report
Final Report for Supply Line 36-1002 Replacement Project

Through this Decision Tree analysis, SoCalGas and SDG&E identified replacement as the more prudent option. Key considerations that support SoCalGas and SDG&E's determination to replace this segment include:

1. Piggability: Non-piggable.
2. Pipe Vintage: 1928.
3. Longseam Type: Unknown.

C. Engineering, Design, and Planning Factors

SoCalGas and SDG&E reviewed pipeline drawings and other information, contacted internal planning groups, communicated with external stakeholders, conducted survey activities, including reviewing public records of the area to confirm the presence of underground utilities and substructures, and completed a pre-design site walk. Key factors that influenced the engineering and design of the Project are as follows:

1. Shut-in Analysis: The Project Team completed a Request for Engineering Review (RER) analysis and concluded that the line could not be shut in and customer service would need to be maintained through alternate means.
2. Customer Impact: Per the RER, SoCalGas and SDG&E can shut in the pipeline without any effect to customers.
3. Environmental: Due to the presence of an existing concrete slab that obstructed the planned excavation site, potholing and soil sample collection would have been costly and lengthy processes that require hand-digging and vacuum excavation. Therefore, SoCalGas and SDG&E opted not to perform potholing or collect soil samples prior to construction.

Pipeline Enhancement Safety Plan Final Report
Final Report for Supply Line 36-1002 Replacement Project

D. Scope Changes

SoCalGas and SDG&E did not make any notable scope changes during detailed design.

Pipeline Enhancement Safety Plan Final Report
Final Report for Supply Line 36-1002 Replacement Project

III. CONSTRUCTION

A. Construction Contractor Selection

The Project Team prepared an initial cost estimate based on the preliminary design. Following completion of the engineering, design, and planning activities described above, the Project Team directed the Performance Partner to prepare cost estimates based on a more detailed engineering design package. As indicated above, there were no notable changes in scope between the time when the Project Team prepared the preliminary cost estimate and when the Performance Partner prepared and submitted its Target Price Estimate. SoCalGas and SDG&E awarded the construction contract to the Performance Partner.

1. SoCalGas and SDG&E’s Preliminary Construction Cost Estimate (confidential):
SoCalGas and SDG&E’s preliminary cost estimate for construction was [REDACTED].
2. Construction Contractor’s Target Price Estimate (confidential): The Construction Contractor’s cost estimate was [REDACTED], which was [REDACTED] than SoCalGas and SDG&E’s preliminary cost estimate for construction.

B. Construction Schedule

Table 3: Construction Timeline

Construction Start Date	06/01/2015
Construction Completion Date	08/14/2015
NOP Date	07/30/2015

Pipeline Enhancement Safety Plan Final Report
Final Report for Supply Line 36-1002 Replacement Project

C. Changes During Construction

SoCalGas and SDG&E successfully mitigated conditions during construction in a manner that minimized potential impacts on project scope, cost, and schedule. As a result, these conditions did not result in any notable change orders.

D. Commissioning and Site Restoration

Commissioning activities include restoration of the site, final inspection, and placement of the pipeline back into service, transportation and disposal of hydrotested water and hazardous material, and site demobilization. Closeout activities include development of final drawings, finalization of a reconciliation package, and updates to company recordkeeping systems to reflect the completed scope of work.

Pipeline Enhancement Safety Plan Final Report
Final Report for Supply Line 36-1002 Replacement Project

IV. PROJECT COSTS

A. Cost Avoidance Actions

SoCalGas and SDG&E exercised due diligence in the planning, design, and construction activities for this project to minimize or avoid costs when prudent to do so. As discussed above, the Project Team conducted a site visit to identify and incorporate discernible site conditions into the engineering, design, and planning of the Project. A specific example of cost avoidance action taken on this project is The Project Team avoided construction delays by ordering additional materials to be available for field design changes anticipated necessary to avoid substructures should they be encountered, mitigating the fact that potholing information could not be efficiently obtained during the design phase. Unused materials were returned to the Ancon and were used on other PSEP projects.

B. Cost Estimate

Based on the preliminary design, once the project scope was confirmed and engineering, design, and planning activities were underway, SoCalGas and SDG&E prepared an estimate of the Direct Costs of the Project in the amount of \$2,007,153. This estimate was prepared in April of 2015, using the “SCG Pipeline Estimate Template Rev 2” estimating tool, the most current version of the PSEP Estimate Template at the time. The Project Team considered the conditions known at the time to prepare the preliminary Direct Cost estimate. This estimate reflects the projected Labor, Material, and Services costs anticipated to be incurred to execute the Project.

SoCalGas and SDG&E estimated Indirect Costs of the Project based on the estimated Direct Costs and other project related variables.

Pipeline Enhancement Safety Plan Final Report
Final Report for Supply Line 36-1002 Replacement Project

C. Actual Direct and Indirect Costs

Actual Direct Costs reflect the Labor, Material, and Services costs incurred to execute the Project. Actual Indirect Costs reflect costs for incremental overhead loaders in accordance with Company overhead allocation policies. The total loaded cost of the Project is \$2,035,491.

Table 4: Estimated and Actual Direct Costs and Variances

Direct Costs (\$)	Estimate	Actuals	Delta Over/(Under)
Company Labor	140,691	83,992	(56,699)
Materials	96,897	81,399	(15,498)
Construction Contractor	836,832	632,338	(204,494)
Construction Management & Support	348,052	294,080	(53,972)
Environmental	55,825	115,867	60,042
Engineering & Design	219,141	216,289	(2,852)
Project Management & Services	92,291	160,315	68,024
ROW & Permits	4,400	45,280	40,880
GMA	213,023	212,586	(437)
Total Direct Costs	2,007,152	1,842,146	(165,006)

Table 5: Estimated and Actual Indirect Costs, Total Costs, and Variances

Indirect Costs/Total Costs (\$)	Estimate	Actuals	Delta Over/(Under)
Overheads	211,110	175,514	(35,596)
AFUDC	120,155	15,494	(104,661)
Property Taxes	25,539	2,337	(23,202)
Total Indirect Costs	356,804	193,345	(163,459)
Total Direct Costs	2,007,152	1,842,146	(165,006)
Total Loaded Costs	2,363,956	2,035,491	(328,465)

Pipeline Enhancement Safety Plan Final Report
Final Report for Supply Line 36-1002 Replacement Project

D. Disallowances

There was no disallowance for Supply Line 36-1002 as there were no post-1955 segments included in the Project without records that provide the minimum information to demonstrate compliance with then applicable industry standards or regulatory strength testing and recordkeeping requirements then applicable.

Pipeline Enhancement Safety Plan Final Report
Final Report for Supply Line 36-1002 Replacement Project

V. CONCLUSION

SoCalGas and SDG&E enhanced the safety of their integrated natural gas transmission system by prudently executing the Supply Line 36-1002 Replacement Project. Through this Replacement Project, SoCalGas and SDG&E successfully replaced 178 feet of pipe within the Gaviota Regulator Station in the City of Goleta without impacting customers. The total loaded cost of the Project is \$2,035,491.

SoCalGas and SDG&E executed this project prudently through efficient planning and coordination to complete the construction effort with minimal customer and community impacts. SoCalGas and SDG&E removed contaminants in a safe and efficient manner as to complete the safety enhancement work in a timely manner.

SoCalGas and SDG&E engaged in prudent cost avoidance efforts by: realigning the pipeline within an existing regulator station to avoid additional land expense, engaging in reasonable efforts to promote market-based rates for contractor services and materials, and thoughtfully employing company labor and contractor resources.

End of Supply Line 36-1002 Replacement Project Final Report

Pipeline Safety Enhancement Plan Final Report
Supply Line 36-9-09 North Section 1 Replacement Project

I. SUPPLY LINE 36-9-09 NORTH SECTION 1 REPLACEMENT PROJECT

A. Background and Summary

Supply Line 36-9-09 North Section 1 is a [REDACTED] diameter transmission pipeline that runs approximately six miles along El Camino Real through commercial and residential neighborhoods from Pueblo Avenue to North Forty Road in the County of San Luis Obispo. The pipeline is primarily routed across a Class 3 location and traverses some Class 1 locations. This report describes the activities associated with the Supply Line 36-9-09 North Section 1 Replacement Project, which consists of the replacement and reroute of 5.975 miles of pipeline. The specific attributes of this Project are detailed in Table 1 below. The total loaded cost of the Project is \$53,837,262.

The Supply Line 36-9-09 North Section 1 Replacement Project is a component of Supply Line 36-9-09-North, which was identified in the 2011 PSEP filing¹ as a 16.016-mile replacement project. The pipeline is located in the cities of Atascadero, San Luis Obispo, Pismo Beach, and Arroyo Grande and is primarily routed across a Class 3 location. For project manageability purposes and due to unique characteristics related to non-contiguous portions of the pipeline, SoCalGas and SDG&E divided Supply Line-36-9-09 North into several project sections to be managed separately (see Figure 1). Two key reasons drove the decision to manage the work on Supply Line 36-9-09 North in this manner; the sections were in different locations, and they were physically separated from each other by non-PSEP segments of pipeline. Additionally, project scopes (hydrotesting, replacement or abandonment) differed among the sections, which drove differing permit acquisition timelines.

¹ See Amended PSEP of SoCalGas and SDG&E, submitted December 2, 2011, in R.11-02-019 and subsequently transferred to A.11-11-002.

Pipeline Safety Enhancement Plan Final Report
Supply Line 36-9-09 North Section 1 Replacement Project

Table 1: General Project Information

Project Name	Supply Line 36-9-09 North Section 1		
Project Type	Replacement		
Length	5.975 miles		
Class	3		
Location	Atascadero		
MAOP (<i>confidential</i>)	[REDACTED]		
Pipe Vintage	1920		
Construction Start	05/11/2015		
Construction Finish	01/31/2017		
Original Pipe Diameter (<i>confidential</i>)	[REDACTED]		
New Diameter (<i>confidential</i>)	[REDACTED]		
Original SMYS ² (<i>confidential</i>)	[REDACTED]		
New SMYS (<i>confidential</i>)	[REDACTED]		
Project Costs (\$)	Capital	O&M	Total
Loaded Project Costs	53,835,181	2,081	53,837,262
Disallowed Costs	-	-	-

² Highest percentage of Specified Minimum Yield Strength (SMYS) of Category 4 Criteria pipe.

Pipeline Safety Enhancement Plan Final Report
Supply Line 36-9-09 North Section 1 Replacement Project

B. Maps and Images

Figure 1: Map of Supply Line 36-9-09 North PSEP Projects



Pipeline Safety Enhancement Plan Final Report
Supply Line 36-9-09 North Section 1 Replacement Project

Figure 2: Satellite Image of Supply Line 36-9-09 North Section 1 Replacement Project

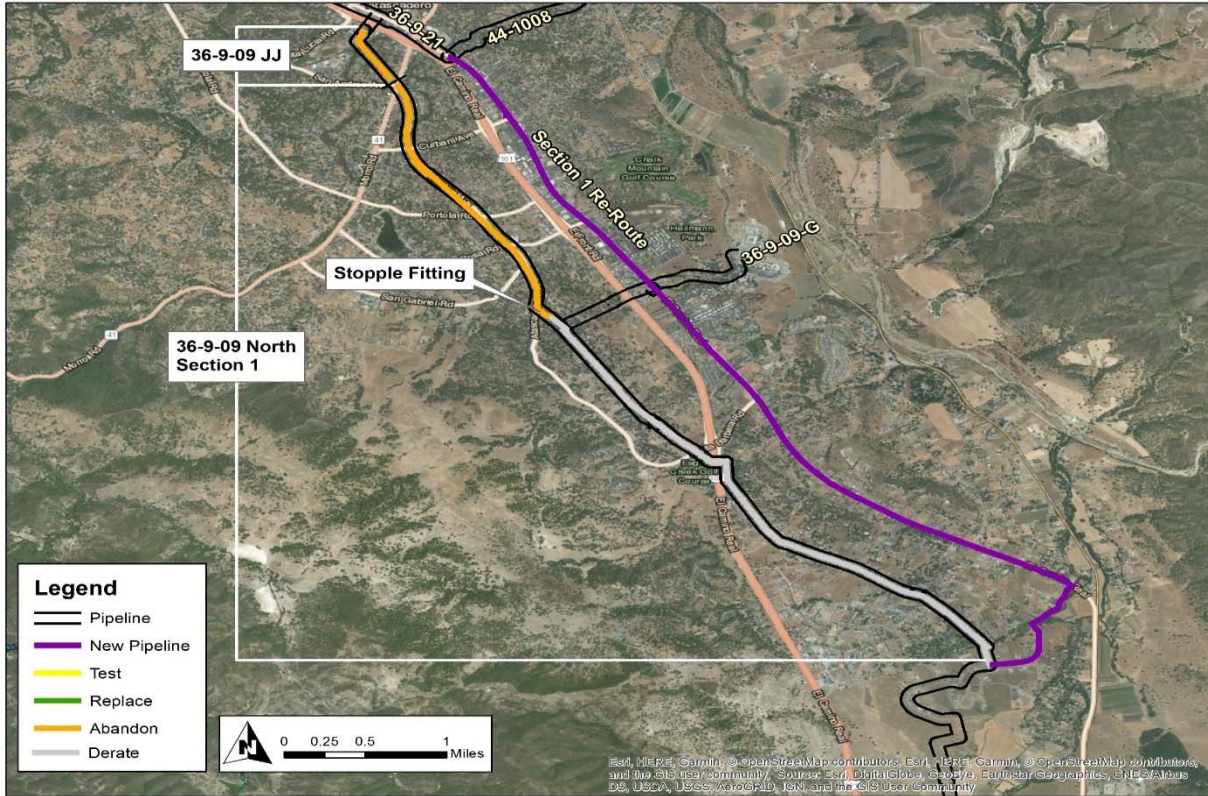

Pipeline Safety Enhancement Plan Final Report
 Supply Line 36-9-09 North Section 1 Replacement Project

Figure 3: Overview Map of Line 36-9-09 North Section 1 Replacement Project

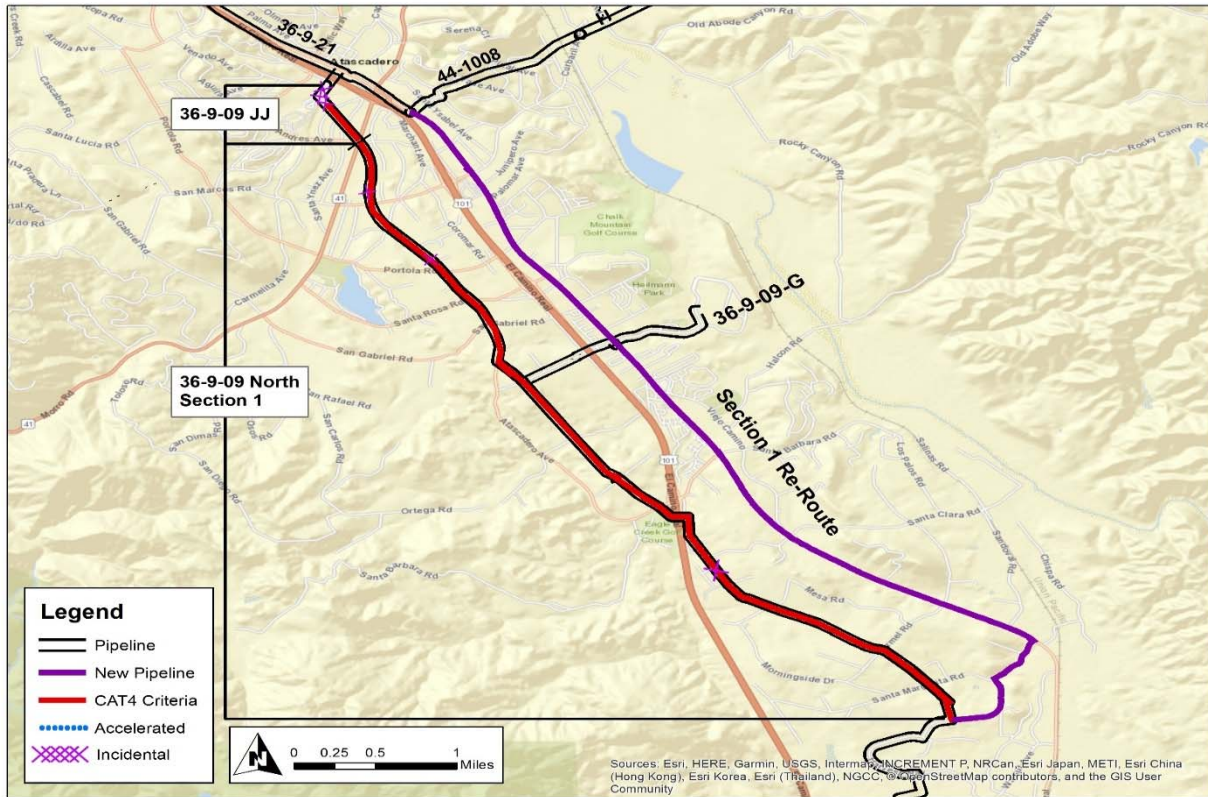

Pipeline Safety Enhancement Plan Final Report
Supply Line 36-9-09 North Section 1 Replacement Project

II. ENGINEERING, DESIGN, AND PLANNING

A. Project Scope

Table 2: Mileage Information³

	Criteria	Accelerated ³	Incidental	New	Total ⁴
Final Mileage	5.502 mi.	0.006 mi.	0.478 mi.	0 mi.	5.975 mi.
	29,054 ft.	29 ft.	2,523 ft.	0 ft.	31,549 ft.

SoCalGas and SDG&E presented a conceptual project scope in workpapers supporting the 2011 PSEP filing. Prior to initiating execution of the Project in 2015, SoCalGas and SDG&E reviewed existing pipeline records to validate the scope of the Project. During the Engineering, Design, and Planning phase, SoCalGas and SDG&E further refined the scope. This progression of the project scope is summarized as follows:

1. 2011 PSEP Filing: SoCalGas and SDG&E identified Supply Line 36-9-09 North as a Phase 1A Replacement Project comprised of 9.662 miles of Category 4 Criteria pipe and 6.354 miles of Accelerated pipe. Supply Line 36-9-09 Section 1 is a section within that project.
2. Scope Validation: Through scope validation activities, after the 2011 filing and before initiating execution of the Project, SoCalGas and SDG&E successfully reduced the scope of the Project by 4.160 miles of Category 4 Criteria pipe.

³ Total mileage of the completed project differs from the mileage of the pipe addressed due to realignment of the pipeline route.

³ Accelerated mileage includes Phase 1B pipe. The Accelerated mileage was included to realize efficiencies and to enhance project constructability.

⁴ Values may not add to total due to rounding.

Pipeline Safety Enhancement Plan Final Report
Supply Line 36-9-09 North Section 1 Replacement Project

3. Engineering, Design, and Constructability:

- a. The Project included a reroute along El Camino Real within city and county franchise to improve accessibility for routine maintenance and emergency response. The existing alignment was no longer easily accessible due to the development of homes and businesses following the original installation.
- b. Approximately 11,000 feet of the existing line will be abandoned with the adjacent Supply Line 36-9-09 JJ Abandonment Project. The remaining portion of the existing Supply Line 36-9-09 North Section 1 will be converted to medium pressure.
- c. Accelerated and Incidental mileage was included because it was located between Category 4 Criteria segments.
- d. Incidental mileage was included to facilitate the abandonment of the existing line.

4. Final Project Scope: The final project scope consists of a 5.975-mile replacement. The Accelerated mileage consists of 29 feet of Phase 1B pipe and 0.478 miles of Incidental pipe.

B. Decision Tree Analysis

SoCalGas and SDG&E performed a PSEP Decision Tree analysis of Supply Line 36-9-09 North Section 1 and confirmed the project design should commence as a Replacement Project.

Pipeline segments installed prior to 1946 that are not capable of being assessed using in-line inspection technology are identified for replacement under the approved PSEP Decision Tree. As explained in the testimony supporting the approved PSEP, as part of the work previously completed during implementation of federal gas transmission pipeline integrity management regulations (49 CFR 192, Subpart O), SoCalGas and

Pipeline Safety Enhancement Plan Final Report
Supply Line 36-9-09 North Section 1 Replacement Project

SDG&E previously identified, retrofitted and in-line inspected pre-1946 transmission pipelines that were constructed using acceptable welding techniques and are operationally suited to in-line inspection. The remaining pre-1946 segments in the SoCalGas/SDG&E system are not suited for in-line inspection, likely have non-state-of-the-art welds and would require significant investment for retrofitting to accommodate in-line inspection tools. Accordingly, consistent with the Commission’s directive in D.11-06-017 to “address retrofitting pipeline to allow for inline inspection tools,” the requirement in California Public Utilities Code section 958 that upon completion of the PSEP, where warranted, pipelines are to be capable of accommodating in-line inspection devices, and the overarching objectives of PSEP to enhance the safety of the pipeline system in a proactive, cost effective manner, the approved PSEP Decision Tree identifies pre-1946 non-piggable pipeline segments for abandonment and/or replacement.

Through this Decision Tree analysis, SoCalGas and SDG&E identified replacement as the more prudent option. Key considerations that support SoCalGas and SDG&E’s determination to replace this segment include:

1. Shut-In Analysis: The Project Team completed a Request for Engineering Review (RER) analysis and concluded that the line could not be shut-in during normal winter or peak winter conditions due to anticipated customer demands off the affected regulator stations.
2. Customer Impacts: SoCalGas and SDG&E would have been required to provide compressed natural gas (CNG) support if the shut-in was performed during normal winter or peak winter conditions. The Project Team completed the Project outside of this window.
3. Community Impacts: There are multiple homes, businesses, and heavy traffic along the proposed alignment for the pipeline replacement route along El Camino Real.

Pipeline Safety Enhancement Plan Final Report
Supply Line 36-9-09 North Section 1 Replacement Project

4. Piggability: Non-piggable.
5. Existing Pipe Attributes: Multiple pipe diameters ranging from [REDACTED] to [REDACTED].
6. Pipe Vintage: 1920.
7. Longseam Type: Unknown.
8. Longseam Repair History: No identified issues.
9. Condition of Coating: No identified issues.
10. History of Leaks: No identified issues.

C. Engineering, Design, and Planning Factors

SoCalGas and SDG&E reviewed pipeline drawings and other information, contacted internal planning groups, communicated with external stakeholders, conducted survey activities, including reviewing public records and potholing of the area to confirm the presence of underground utilities and substructures, and completed a pre-design site walk. Key factors that influenced the engineering and design of the Project are as follows:

1. Reroute:
 - a. The Project Team relocated Supply Line 36-9-09 North Section 1 to the east side of Highway 101 in El Camino Real from Atascadero Avenue, within city and county franchise, to improve accessibility for routine maintenance and emergency response. The reroute avoided the installation of a new Highway 101 crossing; replacement along narrow roads through residential neighborhoods on Atascadero Avenue and Colorado Road; and the need to obtain new rights-of-way for multiple private property crossings. The existing alignment is sited on private property and was no longer easily accessible due to the development of homes and businesses following the original installation.

Pipeline Safety Enhancement Plan Final Report
Supply Line 36-9-09 North Section 1 Replacement Project

- b. The relocation of Supply Line 36-9-09 North Section 1 from Atascadero Avenue and private property to El Camino Real is feasible and would not cause adverse changes to the system.
2. Diameter Changes: The Project Team replaced the existing [REDACTED] line with a [REDACTED] line based on the recommendation of the RER, and to standardize the pipeline diameter to enhance piggability.
3. Known Substructures: The ground penetrating radar (GPR) report revealed and confirmed substructures that required design work to avoid them.
4. Permit Conditions: San Luis Obispo County imposed restrictive permit conditions, including reduced work space and curtailed workday hours.
5. Land Use: This project shared a laydown yard with the Supply Line 36-9-09 JJ Project.

D. Scope Changes

Through engineering, design, and planning activities, SoCalGas and SDG&E determined that changes in scope were appropriate to enhance the design of the Project and address engineering factors. As a result, the preliminary cost estimate does not fully reflect the final scope. Summarized below are notable changes in scope made after the preliminary cost estimate was developed and approved.

1. Permit Requirements: San Luis Obispo County required that the depth of cover be increased from 48-inches to a minimum of 60 inches and a 24-inch vertical separation when crossing underground utilities. This required the Project team to shift the alignment, following the receipt of potholing and GPR information, to meet the more stringent standards imposed by San Luis Obispo County.

Pipeline Safety Enhancement Plan Final Report
Supply Line 36-9-09 North Section 1 Replacement Project

2. Alignment Changes: At the request of San Luis Obispo County, the Project Team shifted the alignment from the east side of Norte Road to the west side to manage traffic to a dead-end street.

3. Construction Execution: SoCalGas and SDG&E planned and designed this project as a single project; however, due to complications of realignment due to separation requirements and a permitting delay with the County of San Luis Obispo, SoCalGas and SDG&E split construction into two sections and developed two construction packages covering the City of Atascadero and San Luis Obispo County. The construction contractor worked continuously—first through the city then onto the county portion—thereby avoiding a demobilization and remobilization.

Pipeline Safety Enhancement Plan Final Report
Supply Line 36-9-09 North Section 1 Replacement Project

III. CONSTRUCTION

A. Construction Contractor Selection

The Project Team prepared an initial cost estimate based on the preliminary design. Following completion of the engineering, design, and planning activities described above, the Project Team directed the Performance Partner to prepare cost estimates based on a more detailed engineering design package, which included the updated design described in the discussion of notable Scope Changes above. SoCalGas and SDG&E awarded the construction contract to the Performance Partner.

1. SoCalGas and SDG&E’s Preliminary Construction Cost Estimate (confidential):
SoCalGas and SDG&E’s preliminary cost estimate for construction was [REDACTED].
2. Construction Contractor’s Target Price Estimate (confidential): The Construction Contractor’s cost estimate was [REDACTED], which was [REDACTED] less than SoCalGas and SDG&E’s preliminary cost estimate for construction.

B. Construction Schedule

Table 3: Construction Timeline

Construction Start Date	05/11/2015
Construction Completion Date	01/31/2017
NOP Date	07/28/2016

C. Changes During Construction

The conditions summarized below were encountered during construction. Activities to address or mitigate these conditions resulted in approximately \$4,780,000 in change orders.

Pipeline Safety Enhancement Plan Final Report
Supply Line 36-9-09 North Section 1 Replacement Project

1. Site Conditions:
 - a. The Construction Contractor encountered approximately 10,900 feet of 16-inch thick asphalt, as opposed to the anticipated 8-inch thick asphalt. This required additional saw cutting and excavation.
 - b. Due to the presence of ground water in the bell holes, the Project Team built platforms for the welders to safely complete their work.
2. Schedule Delay: Due to the multiple alignment changes, onsite activities lasted an additional 91 days. Field overheads were also extended to support the completion of this project.
 - a. An impending City of Pismo Beach road moratorium on the Supply Line 36-9-09 North Section 5A Project necessitated shifting SoCalGas and SDG&E tie-in crews from the Supply Line 36-9-09 North Section 1 Project to the Supply Line 36-9-09 North Section 5A Project. The Construction Contractor at 36-9-09 Section 1 was on standby for the tie-in. During this stand by, the Construction Contractor maintained the excavation sites and yards.
3. Permits Conditions: This project underwent several non-contiguous paving and traffic control changes at the request of a city inspector. These changes typically caused the Construction Contractor to provide additional saw cutting, paving, and traffic control to satisfy the requirements set forth by the city.
 - a. The city requested micro-surfacing (slurry seal) from gutter line to gutter line of El Camino Real, as opposed to the planned one-half width.
 - b. The city requested additional grinding and paving prior to the slurry seal and the installation of concrete collars around approximately 32 cathodic protection stations. This also required additional traffic control.

Pipeline Safety Enhancement Plan Final Report
Supply Line 36-9-09 North Section 1 Replacement Project

- c. The city requested the asphalt thickness be increased to 9.5-inches from the planned 7-inch thickness.
 - d. The city stopped the paving and required the Construction Contractor to saw cut and remove multiple areas of damaged existing asphalt.
4. Substructures: This project underwent several alignment changes due to unmarked substructures. These unmarked substructures typically caused the Construction Contractor to provide additional potholing, saw cutting, paving, shoring and excavation activities to maintain minimum separation from adjacent substructures.
- a. The non-contiguous segments of the new alignment required additional slot trenching and potholing to maintain minimum separation from adjacent substructures, per city inspector requirements.
 - b. Additional excavation, shoring, and traffic control were required to maintain clearance from a duct bank near a valve bridal location. Further complicating construction, the Project Team encountered ground water, which necessitated the use of hydraulic shields.
5. Tie-In: The north tie-in configuration was relocated to the center of El Camino Real due to the discovery of casing during construction potholing.
6. Traffic: This project underwent several non-contiguous alignment changes in the roadway. These alignment changes typically caused the Construction Contractor to provide additional traffic control equipment and personnel.
- a. To maintain uninterrupted ingress and egress to a local hospital, additional traffic control was needed at San Rafael Road.

Pipeline Safety Enhancement Plan Final Report
Supply Line 36-9-09 North Section 1 Replacement Project

- b. To maintain uninterrupted access to businesses along the El Camino Real corridor during construction, the Project Team shifted the alignment to the center of an adjacent traffic lane.
7. Gas Handling: To reduce the impact to traffic at San Rafael Road and El Camino Real, the isolation point was relocated to Colorado Road and San Rafael Road.
8. Weather: A rain storm flooded the trench and caused erosion issues. This required cleaning of the trench and the area around the pipe to prepare it for backfill.
9. Site Restoration: The city requested that four open excavations be backfilled while construction continued in the county portion. These sites had to be excavated again to complete the hydrotest and tie-in.

Pipeline Safety Enhancement Plan Final Report
Supply Line 36-9-09 North Section 1 Replacement Project

Figure 4: Spotter Signaling to Operator Overhead Wires



Pipeline Safety Enhancement Plan Final Report
Supply Line 36-9-09 North Section 1 Replacement Project

Figure 5: Slurrying New Pipeline



Pipeline Safety Enhancement Plan Final Report
Supply Line 36-9-09 North Section 1 Replacement Project

Figure 6: Laying Double Joints in Narrow Right-of-Way



Pipeline Safety Enhancement Plan Final Report
Supply Line 36-9-09 North Section 1 Replacement Project

Figure 7: Safety Tape Over Pipe



Pipeline Safety Enhancement Plan Final Report
Supply Line 36-9-09 North Section 1 Replacement Project

D. Commissioning and Site Restoration

Commissioning activities include restoration of the site, final inspection and placement of the pipeline back into service, transportation and disposal of hydrotested water and hazardous material, and site demobilization.

Closeout activities include development of final as-built drawings, finalization of a reconciliation package, and updates to company recordkeeping systems to reflect the completed scope of work.

Pipeline Safety Enhancement Plan Final Report
Supply Line 36-9-09 North Section 1 Replacement Project

IV. PROJECT COSTS

A. Cost Avoidance Actions

SoCalGas and SDG&E exercised due diligence in the planning, design, and construction activities for this project to minimize or avoid costs when prudent to do so. As discussed above, the Project Team conducted a site visit to identify and incorporate discernible site conditions into the engineering, design, and planning of the Project. Specific examples of cost avoidance actions taken on this project are:

1. Materials: Bulk ordering provided volume pricing for the [REDACTED] pipe.
2. Planning and Coordination: Since Supply Line 36-9-09 North Section 1 was in service prior to the completion of the abandonment of the adjacent Supply Line 36-9-09 JJ Abandonment Project, the Project was able to avoid the cost of installing a planned stopple fitting.
3. Construction Execution: The Project Team originally planned the hydrotest of the new pipeline in two phases, city installation and county installation, but changed the plan to one continuous test.

B. Cost Estimate

Based on the preliminary design, once the project scope was confirmed and engineering, design, and planning activities were underway, SoCalGas and SDG&E prepared an estimate of the Direct Costs of the Project in the amount of \$34,244,356. This estimate was prepared in May of 2014, using the “SCG Pipeline Estimate Template Rev 0” estimating tool, the most current version of the PSEP Estimate Template at the time. The Project Team considered the conditions known at the time to prepare the preliminary Direct Cost estimate. This estimate reflects the projected Labor, Material and Services costs anticipated to be incurred to execute the Project.

Pipeline Safety Enhancement Plan Final Report
Supply Line 36-9-09 North Section 1 Replacement Project

SoCalGas and SDG&E estimated Indirect Costs of the Project based on the estimated Direct Costs and other Project related variables.

C. Actual Direct and Indirect Costs

Actual Direct Costs reflect the Labor, Material, and Service costs incurred to execute the Project. Actual Indirect Costs reflect costs for incremental overhead loaders in accordance with Company overhead allocation policies. The total loaded cost of the Project is \$53,837,262.

Pipeline Safety Enhancement Plan Final Report
Supply Line 36-9-09 North Section 1 Replacement Project

Table 4: Estimated and Actual Direct Costs and Variances

Direct Costs (\$)	Estimate	Actuals	Delta Over/(Under)
Company Labor	382,310	738,766	356,456
Materials	1,610,427	1,530,667	(79,760)
Construction Contractor	24,735,025	26,081,030	1,346,005
Construction Management & Support	333,520	4,309,219	3,975,699
Environmental	461,450	1,440,549	979,099
Engineering & Design	1,991,056	5,427,680	3,436,624
Project Management & Services	563,996	1,380,970	816,974
ROW & Permits	547,250	748,387	201,137
GMA	3,619,322	5,181,922	1,562,600
Total Direct Costs	34,244,356	46,839,190	12,594,834

Table 5: Estimated and Actual Indirect Costs, Total Costs, and Variances

Indirect Costs/Total Costs (\$)	Estimate	Actuals	Delta Over/(Under)
Overheads	2,904,818	3,814,429	909,611
AFUDC	3,017,761	2,820,514	(197,247)
Property Taxes	605,449	363,129	(242,320)
Total Indirect Costs	6,528,028	6,998,072	470,044
Total Direct Costs	34,244,356	46,839,190	12,594,834
Total Loaded Costs	40,772,384	53,837,262	13,064,878

D. Disallowance

There is no disallowance calculation for the Supply Line 36-9-09 North Section 1 Project as there were no post-1955 segments included in the Project without records that provide the minimum information to demonstrate compliance with then applicable industry standards or regulatory strength testing and recordkeeping requirements then applicable.

Pipeline Safety Enhancement Plan Final Report
Supply Line 36-9-09 North Section 1 Replacement Project

V. CONCLUSION

SoCalGas and SDG&E enhanced the safety of their integrated natural gas transmission system by prudently executing the Supply Line 36-9-09 North Section 1 Replacement Project. Through this Replacement Project, SoCalGas and SDG&E successfully replaced and rerouted 5.975 miles of pipe in the City of Atascadero and San Luis Obispo County. The total loaded cost of the Project is \$53,837,262.

SoCalGas and SDG&E executed this project prudently by using construction methods of open-cut trenching and alignment changes for routing around unknown existing utilities and adapting to other challenging field conditions for a successful pipeline installation; and enhanced piggability through the replacement of non-piggable pipe features.

SoCalGas and SDG&E engaged in prudent cost avoidance efforts by engaging in reasonable efforts to promote competitive and market-based rates for contractor services and materials and using a reasonable amount of company and contractor resources given the complexity of this project.

End of Supply Line 36-9-09 North Section 1 Replacement Project Final Report

Pipeline Safety Enhancement Plan Final Report
Supply Line 36-9-09 North Section 3 Replacement Project

I. SUPPLY LINE 36-9-09 NORTH SECTION 3 REPLACEMENT PROJECT

A. Background and Summary

Supply Line 36-9-09 North Section 3 is a predominantly [REDACTED] diameter transmission line that runs approximately 3 miles through rural, commercial, and residential neighborhoods from Bridge Street to South Higuera Street in the City of San Luis Obispo. The pipeline is primarily routed across a Class 3 location. This report describes the activities associated with the Supply Line 36-9-09 North Section 3 Replacement Project that consists of the reroute and replacement of 2.956 miles of pipeline. The specific attributes for this Project are detailed in Table 1 below. The total loaded cost of the Project is \$27,247,577.

The Supply Line 36-9-09 North Section 3 Replacement Project is a component of Supply Line 36-9-09-North, that was identified in the 2011 PSEP filing¹ as a 16.016-mile replacement project. The pipeline is located in the cities of Atascadero, San Luis Obispo, Pismo Beach, and Arroyo Grande and is primarily routed across a Class 3 location. For project manageability purposes and due to unique characteristics related to non-contiguous portions of the pipeline, SoCalGas and SDG&E divided Supply Line-36-9-09 North into several project sections to be managed individually (see Figure 1). Two key reasons drove the decision to manage the work on Supply Line 36-9-09 North in this manner; the sections were in different locations, and they were physically separated from each other by non-PSEP segments of pipeline. Additionally, project scopes (hydrotesting, replacement or abandonment) differed among the sections that led to differing permit acquisition timelines.

¹ See Amended PSEP of SoCalGas and SDG&E, submitted December 2, 2011, in R.11-02-019 and subsequently transferred to A.11-11-002.

Pipeline Safety Enhancement Plan Final Report
Supply Line 36-9-09 North Section 3 Replacement Project

Table 1: General Project Information

Project Name	Supply Line 36-9-09 North Section 3		
Project Type	Replacement		
Length	2.956 miles		
Location	San Luis Obispo		
Class	3		
MAOP (<i>confidential</i>)	[REDACTED]		
Pipe Vintage	1927		
Construction Start	12/03/2014		
Construction Finish	11/13/2015		
Original Pipe Diameter (<i>confidential</i>)	[REDACTED]		
New Diameter (<i>confidential</i>)	[REDACTED]		
Original SMYS ² (<i>confidential</i>)	[REDACTED]		
New SMYS (<i>confidential</i>)	[REDACTED]		
Project Costs (\$)	Capital	O&M	Total
Loaded Project Costs	27,243,845	3,732	27,247,577
Disallowed Costs	265,229	-	265,229

² Highest percentage of Specified Minimum Yield Strength (SMYS) of Category 4 Criteria pipe.

Pipeline Safety Enhancement Plan Final Report
Supply Line 36-9-09 North Section 3 Replacement Project

B. Maps and Images

Figure 1 Map of Supply Line 36-9-09 North PSEP Projects



Pipeline Safety Enhancement Plan Final Report
Supply Line 36-9-09 North Section 3 Replacement Project

Figure 2: Satellite Image of Supply Line 36-9-09 North Section 3 Replacement Project

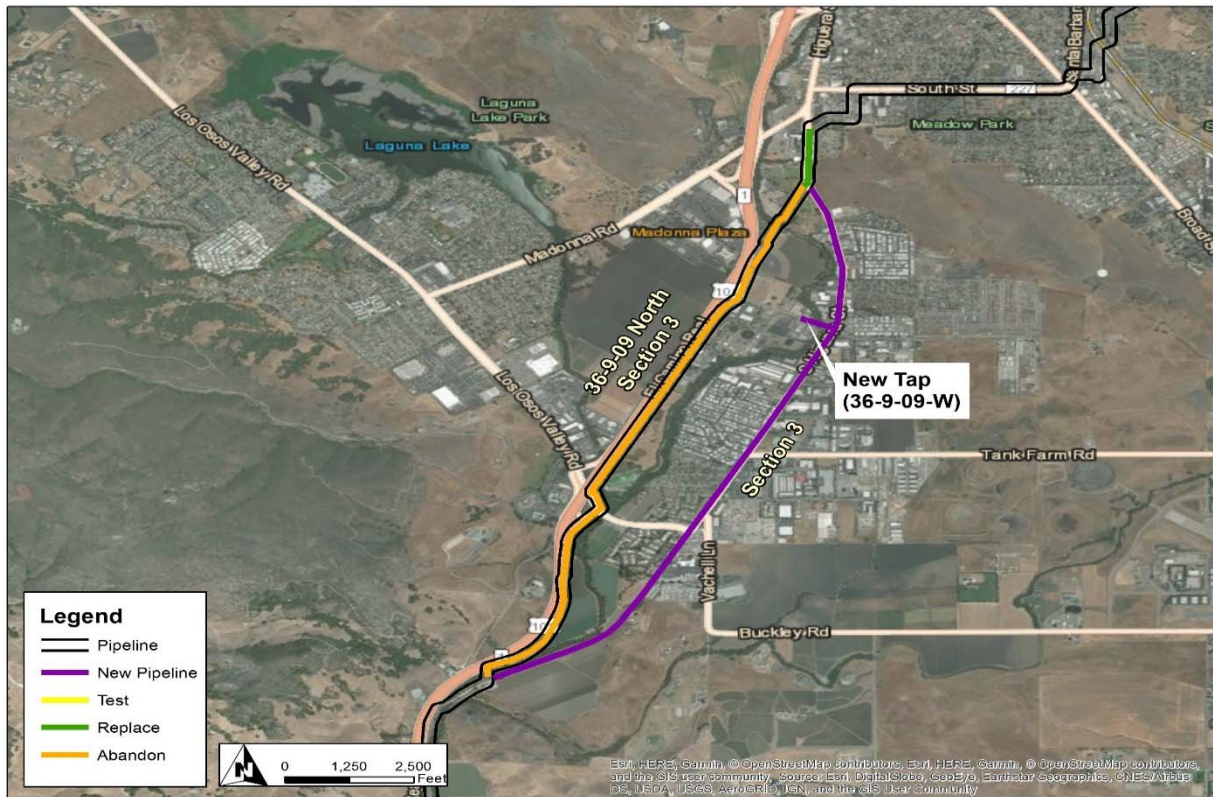

Pipeline Safety Enhancement Plan Final Report
Supply Line 36-9-09 North Section 3 Replacement Project

Figure 3: Overview Map of Supply Line 36-9-09 North Section 3 Replacement Project

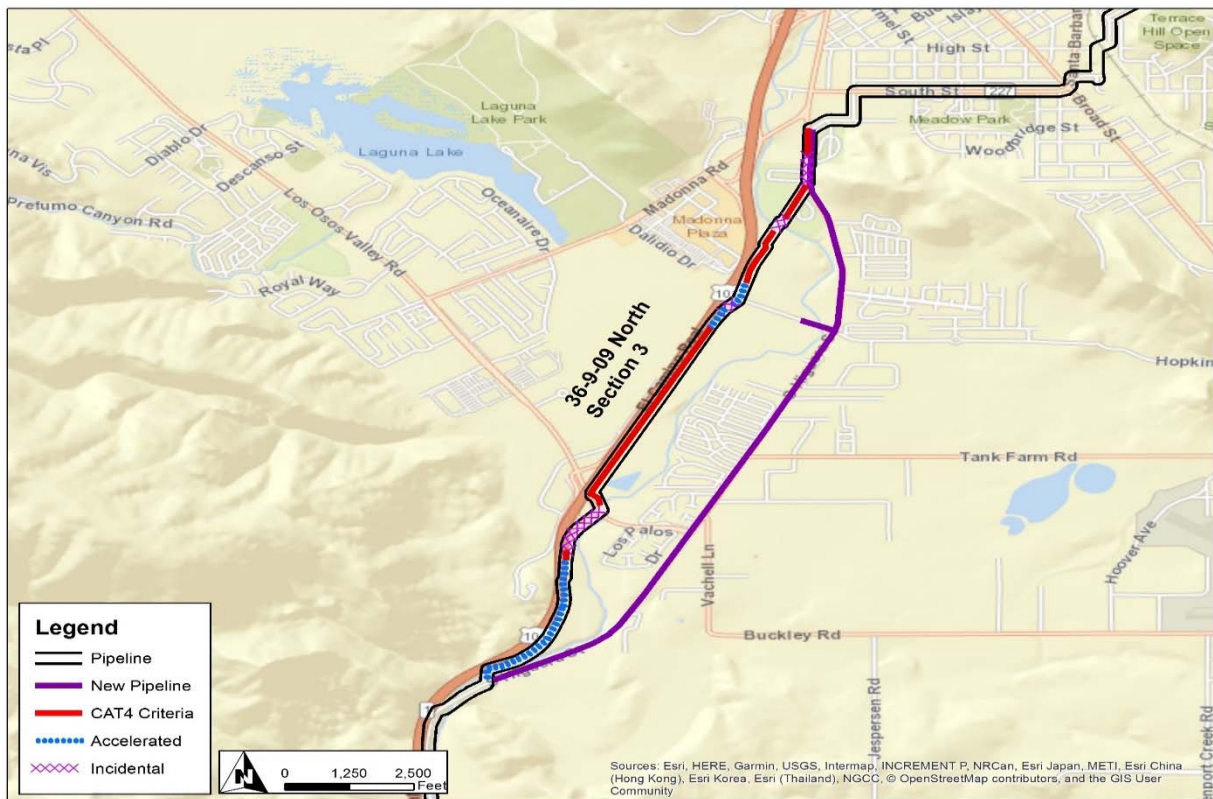

Pipeline Safety Enhancement Plan Final Report
Supply Line 36-9-09 North Section 3 Replacement Project

II. ENGINEERING, DESIGN, AND PLANNING

A. Project Scope

Table 2: Mileage Information

	Criteria	Accelerated ³	Incidental	New	Total ⁴
Final Mileage	1.217 mi.	1.057 mi.	0.560 mi.	0.122 mi.	2.956 mi.
	6,426 ft.	5,578 ft.	2,959 ft.	644 ft.	15,607 ft.

SoCalGas and SDG&E presented a conceptual project scope in workpapers supporting the 2011 PSEP filing. Prior to initiating execution of the Project in 2014, SoCalGas and SDG&E reviewed existing pipeline records to validate the scope of the Project. During the Engineering, Design and Planning phase, SoCalGas and SDG&E further refined the scope. This progression of the project scope is summarized as follows:

1. 2011 PSEP Filing: SoCalGas and SDG&E identified Supply Line 36-9-09 North as a Phase 1A replacement project comprised of 9.662 miles of Category 4 Criteria pipe and 6.354 miles of Accelerated pipe. Supply Line 36-9-09 North Section 3 is a section within that project.
2. Scope Validation: Through scope validation activities, after the 2011 filing and before initiating execution of the Project, SoCalGas and SDG&E successfully reduced the scope of the Project by 8.340 miles of Category 4 Criteria pipe.
3. Engineering, Design, and Constructability:

³ Accelerated mileage includes Phase 1B, Phase 2A, and Phase 2B pipe. Phase 2 includes pipelines without sufficient record of a pressure test in less populated areas (Phase 2A) or pipelines with record of a pressure test, but without record of a pressure test to modern – Subpart J – standards (Phase 2B). The Accelerated mileage was included to realize efficiencies and to enhance project constructability.

⁴ Values may not add to total due to rounding.

Pipeline Safety Enhancement Plan Final Report
Supply Line 36-9-09 North Section 3 Replacement Project

- a. The Project included a reroute along South Higuera Street within city and county franchise to improve accessibility for routine maintenance and emergency response. The existing alignment was no longer easily accessible due to the development of homes, businesses, and Highway 101 since the original installation.
 - b. Accelerated mileage was included due to the location being between Category 4 Criteria segments along the northern end of the selected route. The Accelerated mileage at the southern end of the project was included to prevent future community disruption and avoid costs of a future construction remobilization.
 - c. Incidental mileage was included to facilitate the abandonment of the existing line. Some sections were also located between Category 4 Criteria segments, requiring the Incidental mileage to be included in the design.
4. Final Project Scope: The final project scope consists of a 2.956 mile Replacement. The Accelerated mileage consists of 0.381 miles of Phase 1B pipe, 0.126 miles of Phase 2A pipe, 0.549 miles of Phase 2B pipe, and 0.560 miles of Incidental pipe.

B. Decision Tree Analysis

SoCalGas and SDG&E performed a PSEP Decision Tree analysis of Supply Line 36-9-09 North Section 3 and confirmed the project design should commence as a Replacement Project.

Pipeline Safety Enhancement Plan Final Report
Supply Line 36-9-09 North Section 3 Replacement Project

Pipeline segments installed prior to 1946 that are not capable of being assessed using in-line inspection technology are identified for replacement under the approved PSEP Decision Tree. As explained in the testimony supporting the approved PSEP, as part of the work previously completed during implementation federal gas transmission pipeline integrity management regulations (49 CFR 192, Subpart O), SoCalGas and SDG&E have already identified, retrofitted and in-line inspected pre-1946 transmission pipelines that were constructed using acceptable welding techniques and are operationally suited to in-line inspection. The remaining pre-1946 segments in the SoCalGas/SDG&E system are not suited for in-line inspection, likely have non-state-of-the-art welds, and would require significant investment for retrofitting to accommodate in-line inspection tools. Accordingly, consistent with the Commission’s directive in D.11-06-017 to “address retrofitting pipeline to allow for inline inspection tools,” the requirement in California Public Utilities Code section 958 that upon completion of the PSEP, where warranted, pipelines are to be capable of accommodating in-line inspection devices, and the overarching objectives of PSEP to enhance the safety of the pipeline system in a proactive, cost effective manner, the approved PSEP Decision Tree identifies pre-1946 non-piggable pipeline segments for abandonment and/or replacement.

Through this Decision Tree analysis, SoCalGas and SDG&E identified replacement as the more prudent option. Key considerations that support SoCalGas and SDG&E’s determination to replace this segment include:

1. Shut-In Analysis: The Project Team completed a Request for Engineering Review (RER) analysis and concluded that the line could only be taken out of service if temporary service, compressed natural gas (CNG), was provided at multiple locations to maintain direct customer taps and regulator station demands during replacement tie-in operations.

Pipeline Safety Enhancement Plan Final Report
Supply Line 36-9-09 North Section 3 Replacement Project

2. Piggability: Non-piggable.
3. Existing Pipe Attributes: Multiple pipe diameters ranging from [REDACTED] to [REDACTED]
4. Pipe Vintage: 1927.
5. Longseam Type: Unknown.
6. Longseam Repair History: No identified issues.
7. Condition of Coating: No identified issues.
8. History of Leaks: No identified issues.

Pipeline Safety Enhancement Plan Final Report
Supply Line 36-9-09 North Section 3 Replacement Project

C. Engineering, Design, and Planning Factors

SoCalGas and SDG&E reviewed pipeline drawings and other information, contacted internal planning groups, communicated with external stakeholders, conducted survey activities, including reviewing public records and potholing of the area to confirm the presence of underground utilities and substructures, and completed a pre-design site walk. Key factors that influenced the engineering and design of the Project are as follows:

1. Reroute:

- a. The Project Team relocated Supply Line 36-9-09 North Section 3 to South Higuera Street from east side of Highway 101 within city and county franchise to improve accessibility for routine maintenance and emergency response. The reroute would avoid Caltrans right of way (ROW) for Highway 101; eliminate three creek crossings; replacement along the narrow road, Elks Lane; and obtaining new ROWs for multiple private property crossings. The existing alignment was no longer easily accessible in the private property section due to the development of homes and businesses since the original installation.
- b. To accommodate the reroute, the Project Team would replace and reroute approximately 620 feet of the adjacent connected small diameter Supply Line 36-9-09 W to maintain tap service to a CNG refueling station.

2. Diameter Changes: The Project Team replaced the existing [REDACTED] line with a [REDACTED] line based on the recommendation of the RER and to standardize the pipeline diameter for future pigging purposes.

Pipeline Safety Enhancement Plan Final Report
Supply Line 36-9-09 North Section 3 Replacement Project

3. Permit Conditions: The City of San Luis Obispo requested that the Project maintain two lanes of traffic at all times, resulting in challenging traffic control conditions. Many businesses along the proposed route required outreach and potential mitigation to limit disruptions.
4. Known Substructures: The ground penetrating radar (GPR) report revealed and confirmed the location of substructures that needed to be avoided. The City of San Luis Obispo permitted only five potholes prior to construction.
5. Environmental: The selected reroute along franchise reduced the environmental impact and the number of potential jurisdictional permits.

D. Scope Changes

SoCalGas and SDG&E did not make any notable scope changes during detailed design.

Pipeline Safety Enhancement Plan Final Report
Supply Line 36-9-09 North Section 3 Replacement Project

III. CONSTRUCTION

A. Construction Contractor Selection

The Project Team prepared an initial cost estimate based on the preliminary design. Following completion of the engineering, design, and planning activities described above, the Project Team directed the Performance Partner to prepare cost estimates based on a more detailed engineering design package, that included the updated design described in the discussion of notable Scope Changes above. SoCalGas and SDG&E awarded the construction contract to the Performance Partner.

1. SoCalGas and SDG&E’s Preliminary Construction Cost Estimate (*confidential*):

SoCalGas and SDG&E’s preliminary cost estimate for construction was

██████████.

2. Construction Contractor’s Target Price Estimate (*confidential*): The Construction

Contractor’s cost estimate was ██████████, that was ██████████ than

SoCalGas and SDG&E’s preliminary cost estimate for construction.

B. Construction Schedule

Table 3: Construction Timeline

Construction Start Date	12/03/2014
Construction Completion Date	11/13/2015
NOP Date	08/21/2015

Pipeline Safety Enhancement Plan Final Report
Supply Line 36-9-09 North Section 3 Replacement Project

C. Changes During Construction

The conditions summarized below were encountered during construction. Activities to address or mitigate these conditions resulted in approximately \$6,267,700 in change orders.

1. Substructures:

- a. Due to multiple encounters with several unknown substructures and alignment changes over an approximate distance of 8,300 feet, the Construction Contractor provided additional trenching, shoring, and labor to maintain vertical clearance from existing utilities.
- b. The Project Team encountered previously unidentified existing lines (abandoned sewer, water line, medium pressure gas line) in close proximity to the project alignment. The Construction Contractor potholed every 200 feet for approximately 13,000 feet, a total of 65 potholes, to verify the horizontal separation between the existing lines and the proposed alignment.
- c. During excavation, the Project Team uncovered an unmarked abandoned 26-inch sewer in the path of the alignment. The Project Team demolished and removed an approximately 759 foot section of sewer pipe and manholes to accommodate pipe installation. This led to a 15-day delay.
- d. The Project Team identified a reclaimed water line, existing high-pressure gas line, and a fiber optic line within the minimum distance of the designed piping alignment. The alignment was altered to maintain 5 feet of separation.

Pipeline Safety Enhancement Plan Final Report
Supply Line 36-9-09 North Section 3 Replacement Project

- e. Per City of San Luis Obispo (City) permit requirements, the Project Team made pre-and post-construction videos of eight storm drains and six sewer crossings, resulting in unexpected costs.
 - f. During excavation of the tie-in bell hole, the Project Team identified two unknown and unmarked lines (a water line and a sewer). The Project Team changed the tie-in alignment to allow for routing around existing utilities.
2. Constructability Issues:
- a. The Project Team identified an unexpected 12-inch concrete layer within the road base, running through most of the replacement route. The Project Team had to alter the planned open-cut trench installation method to include demolition of the existing concrete. After the pipe was installed, the Project Team poured concrete to restore it to its original condition. This additional work led to a 21-day delay in the construction schedule.
 - b. Additional excavation was required to expose two girth welds that required reinspection using x-ray.
3. Field Design Changes:
- a. The Project Team had to replace and reroute the adjacent connected small diameter Supply Line 36-9-09 W to maintain tap service, as designed in the original project scope. However, an 18-month permitting process with the local water agency was required prior to execution of the planned water crossing by horizontal direction drill (HDD) installation method. The Project Team executed an alternative installation method, utilizing pipe supports off an existing bridge of a creek crossing.

Pipeline Safety Enhancement Plan Final Report
Supply Line 36-9-09 North Section 3 Replacement Project

- b. The Project Team installed approximately 25 electrolysis testing stations (ETS) over the new pipeline, one every 500 feet.
4. Schedule Delay: Due to the multiple alignment changes, project personnel and equipment were on site an additional eight months. Field overheads (fixed costs) were also extended to support the completion of this project.
5. Work Hours:
 - a. Per City request, the Construction Contractor switched to a night schedule for two weeks to avoid closing off two intersections during the day. Working nights requires additional equipment set-up (light towers, minor lights, trench lights, high visibility PPE), traffic control, and additional activities that led to reduced productivity. This night work occurred from April 19th to April 24th and April 26th to May 1st.
 - b. At the request of the City, the Project Team changed work hours to night shifts to avoid traffic congestion at the intersection of Bridge Street and South Higuera Street. Working nights requires additional equipment set-up (light towers, minor lights, trench lights, high visibility PPE), traffic control, and additional activities that led to reduced productivity. This night work occurred from July 20 to August 14.

Pipeline Safety Enhancement Plan Final Report
Supply Line 36-9-09 North Section 3 Replacement Project

6. Site Restoration:

- a. Due to alignment changes throughout the Project to route the pipeline installation around utilities, the Project Team paved additional lanes for final grind and cap in the city portions of the Project. Per City requirement, the Project Team paved over and recessed the existing sewer/water covers and monuments adjacent to the Project alignment, and brought the lids and monuments to grade.
- b. Following the completion of construction, the land owner requested that the base rock used for the laydown yard be removed.
- c. The Construction Contractor transferred remaining material at the Prado Yard to other laydown yards.

7. Traffic:

- a. The City required flagmen at the corner of Los Osos Valley Road and the school to help alleviate traffic concerns. The city inspector later requested flagmen at all intersections to help traffic flow.
- b. The City requested the Construction Contractor use two additional message boards north of Los Osos Valley Road until construction was completed in that intersection.
- c. Two message boards were required on Higuera Street each day.

8. Construction Method: The Construction Contractor provided additional support to the bore contractor when completing four bores within the project scope.

Pipeline Safety Enhancement Plan Final Report
Supply Line 36-9-09 North Section 3 Replacement Project

9. Environmental: The Project Team encountered potential cultural artifacts on three occasions. The discoveries prompted archeological and Native American artifact monitoring. The Project Team determined the first two (a bone, unmarked railroad tracks embedded in concrete) were not artifacts. The third discovery was of Native American mortar, which delayed work until a monitor and an archeologist could review the finding. One truck with spoils from the excavation remained at the laydown yard for three days until the soil could be dumped onto containment for monitors to sift through.
10. Equipment Needs: During trenching, the Construction Contractor encountered rock and required a breaker to loosen it. The rock was hauled off site for disposal.
11. Soil Contamination: Encounters with contaminated soil, cultural artifacts, and other environmentally sensitive areas slowed overall construction pace and resulted in an increased cost for environmental oversight. SoCalGas and SDG&E performed eight exploratory soil sampling potholes.

Pipeline Safety Enhancement Plan Final Report
Supply Line 36-9-09 North Section 3 Replacement Project

Figure 4: Installation of Pipe along South Higuera Street



Pipeline Safety Enhancement Plan Final Report
Supply Line 36-9-09 North Section 3 Replacement Project

D. Commissioning and Site Restoration

Commissioning activities include restoration of the site, final inspection and placement of the pipeline back into service, transportation and disposal of hydrotested water and hazardous material, and site demobilization. Closeout activities include development of final drawings, finalization of a reconciliation package, and updates to company recordkeeping systems to reflect the completed scope of work.

Pipeline Safety Enhancement Plan Final Report
Supply Line 36-9-09 North Section 3 Replacement Project

IV. PROJECT COSTS

A. Cost Avoidance Actions

SoCalGas and SDG&E exercised due diligence in the planning, design, and construction activities for this project to minimize or avoid costs when prudent to do so. As discussed above, the Project Team conducted a site visit to identify and incorporate discernible site conditions into the engineering, design, and planning of the Project. Specific examples of cost avoidance actions taken on this project are:

1. Scope Change: The replacement of this project included Accelerated pipe segments scheduled for PSEP Phases 1B and 2. Replacing the planned Category 4 Criteria pipe and Accelerated pipe segments provides a projected future cost savings by eliminating the need for additional PSEP construction in the area.
2. Materials: Bulk ordered pipe provided volume pricing for the [REDACTED] pipe. The Project Team purchased the majority of materials by means of bulk ordering with materials for the other Supply Line 36-9-09 North PSEP projects. This reduced material procurement scheduling time and costs.
3. Future Maintenance: Rerouting outside of Caltrans ROW allowed for safer access for future inspection and maintenance on the pipeline, as well as reduced construction costs and permitting durations for future work. The reroute also provided increased sustainability for the pipeline, since the existing alignment could have been in conflict with future highway expansion projects.

Pipeline Safety Enhancement Plan Final Report
Supply Line 36-9-09 North Section 3 Replacement Project

B. Cost Estimate

Based on the preliminary design, once the project scope was confirmed and engineering, design, and planning activities were underway, SoCalGas and SDG&E prepared an estimate of the Direct Costs of the Project in the amount of \$15,943,055. This estimate was prepared in April of 2014, using the “SCG Pipeline Estimate Template Rev 0” estimating tool, the most current version of the PSEP Estimate Template at the time. The Project Team considered the conditions known at the time to prepare the preliminary Direct Cost estimate. This estimate reflects the projected Labor, Material, and Services costs anticipated to be incurred to execute the Project.

SoCalGas and SDG&E estimated Indirect Costs of the Project based on the estimated Direct Costs and other project-related variables.

C. Actual Direct and Indirect Costs

Actual Direct Costs reflect the Labor, Material, and Service costs incurred to execute the Project. Actual Indirect Costs reflect costs for incremental overhead loaders in accordance with Company overhead allocation policies. The total loaded cost of the Project is \$27,247,577.

Pipeline Safety Enhancement Plan Final Report
Supply Line 36-9-09 North Section 3 Replacement Project

Table 4: Estimated and Actual Direct Costs and Variances

Direct Costs (\$)	Estimate	Actuals	Delta Over/(Under)
Company Labor	742,874	237,649	(505,225)
Materials	878,492	683,385	(195,107)
Construction Contractor	10,524,857	13,717,833	3,192,976
Construction Management & Support	121,000	3,369,717	3,248,717
Environmental	236,500	1,293,624	1,057,124
Engineering & Design	1,039,038	2,523,819	1,484,781
Project Management & Services	476,370	438,905	(37,465)
ROW & Permits	238,886	261,553	22,667
GMA	1,685,038	2,928,805	1,243,767
Total Direct Costs	15,943,055	25,455,290	9,512,235

Table 5: Estimated and Actual Indirect Costs, Total Costs, and Variances

Indirect Costs/Total Costs (\$)	Estimate	Actuals	Delta Over/(Under)
Overheads	1,860,523	1,733,745	(126,778)
AFUDC	569,127	6,378	(562,749)
Property Taxes	110,703	52,164	(58,539)
Total Indirect Costs	2,540,353	1,792,287	(748,066)
Total Direct Costs	15,943,055	25,455,290	9,512,235
Total Loaded Costs	18,483,408	27,247,577	8,764,169

Pipeline Safety Enhancement Plan Final Report
Supply Line 36-9-09 North Section 3 Replacement Project

D. Disallowances

For this replacement project, SoCalGas and SDG&E identified 0.126 miles of pipe installed after 1955 and lacking records that provide the minimum information necessary to demonstrate compliance with then-applicable industry standards or regulatory strength testing and recordkeeping requirements. Of the pipeline that was replaced, 0.126 miles of Phase 1A pipe are disallowed. Therefore, a \$265,229 reduction to ratebase was calculated by multiplying 0.126 miles of pipe by \$2,105,878 per mile, which was SoCalGas and SDG&E's system average cost of pressure testing at the time the pipeline was returned to service.

Pipeline Safety Enhancement Plan Final Report
Supply Line 36-9-09 North Section 3 Replacement Project

V. CONCLUSION

SoCalGas and SDG&E enhanced the safety of their integrated natural gas transmission system by prudently executing the Supply Line 36-9-09 North Section 3 Replacement Project. Through this Replacement Project, SoCalGas and SDG&E successfully replaced and rerouted 2.956 miles of pipe in the City of San Luis Obispo. The total loaded cost of the Project is \$27,247,577.

SoCalGas and SDG&E executed this project prudently through using construction methods of slick bore, open-cut trenching, and alignment changes for routing around unknown existing utilities and adapting to other challenging field conditions for a successful pipeline installation. SoCalGas and SDG&E also enhanced piggability through the replacement of non-piggable pipe.

SoCalGas and SDG&E engaged in prudent cost avoidance efforts by bulk ordering materials; incorporated future phases of PSEP mileage to avoid the costs of a subsequent construction mobilization; engaged in reasonable efforts to promote competitive and market-based rates for contractor services and materials using market-based rates, based on a recent competitive sourcing event; and used a reasonable amount of company and contractor resources given the complex scope and field changes driven by identified unknown substructures.

End of Supply Line 36-9-09 North Section 3 Replacement Project Final Report

Pipeline Safety Enhancement Plan Final Report
Supply Line 36-9-09 Section 4A and 4B Replacement Project

I. SUPPLY LINE 36-9-09 NORTH SECTION 4A AND 4B REPLACEMENT PROJECT

A. Background and Summary

Supply Line 36-9-09 North Section 4A and 4B Replacement Project is an [REDACTED] transmission pipeline that runs adjacent to Highway 101 in the City of Avila Beach. The pipeline is primarily routed across a Class 3 location. This report describes the activity associated with the Supply Line 36-9-09 North Section 4A and 4B Replacement Project that consists of replacement and reroute of 1.034 miles of pipeline. The specific attributes of this Project are detailed in Table 1 below. The total loaded cost of the Project is \$15,145,332.

The Supply Line 36-9-09 North Section 4A and 4B Replacement Project is a component of Supply Line 36-9-09-North, that was identified in the 2011 PSEP filing¹ as a 16.016-mile replacement project. The pipeline is located in the cities of Atascadero, San Luis Obispo, Pismo Beach, and Arroyo Grande and is primarily routed across a Class 3 location. For project manageability purposes and due to unique characteristics related to non-contiguous portions of the pipeline, SoCalGas and SDG&E divided Supply Line-36-9-09 North into several project sections to be managed individually (see Figure 1). Two key reasons drove the decision to manage the work on Supply Line 36-9-09 North in this manner; the sections were in different locations, and they were physically separated from each other by non-PSEP segments of pipeline. Additionally, project scopes (hydrotesting, replacement or abandonment) differed among the sections that led to differing permit acquisition timelines.

¹ See Amended PSEP of SoCalGas and SDG&E, submitted December 2, 2011, in R.11-02-019 and subsequently transferred to A.11-11-002.

Pipeline Safety Enhancement Plan Final Report Supply Line 36-9-09 Section 4A and 4B Replacement Project

Table 1: General Project Information

Project Name		Section 4A		
Project Type	Replacement			
Length	0.579 miles			
Location	Avila Beach			
Class	3			
MAOP (<i>confidential</i>)	████████			
Pipe Vintage	1940			
Construction Start	05/30/2017			
Construction Finish	08/03/2017			
Original Pipe Diameter (<i>confidential</i>)	████████			
New Diameter (<i>confidential</i>)	████████			
Original SMYS ² (<i>confidential</i>)	██████			
New SMYS (<i>confidential</i>)	██████			
Project Name		Section 4B		
Project Type	Replacement			
Length	0.455 miles			
Location	Avila Beach			
Class	3			
MAOP (<i>confidential</i>)	████████			
Pipe Vintage	1940			
Construction Start	09/15/2014			
Construction Finish	01/09/2015			
Original Pipe Diameter (<i>confidential</i>)	████████			
New Diameter (<i>confidential</i>)	████████			
Original SMYS ³ (<i>confidential</i>)	██████			
New SMYS (<i>confidential</i>)	██████			
Project Costs (\$)		Capital	O&M	Total
Loaded Project Costs	15,145,332	0	15,145,332	
Disallowed Costs	0	0	0	

² Highest percentage of Specified Minimum Yield Strength (SMYS) of Category 4 Criteria pipe.

³ Ibid.

Pipeline Safety Enhancement Plan Final Report
Supply Line 36-9-09 Section 4A and 4B Replacement Project

B. Maps and Images

Figure 1: Map of Supply Line 36-9-09 North PSEP Projects

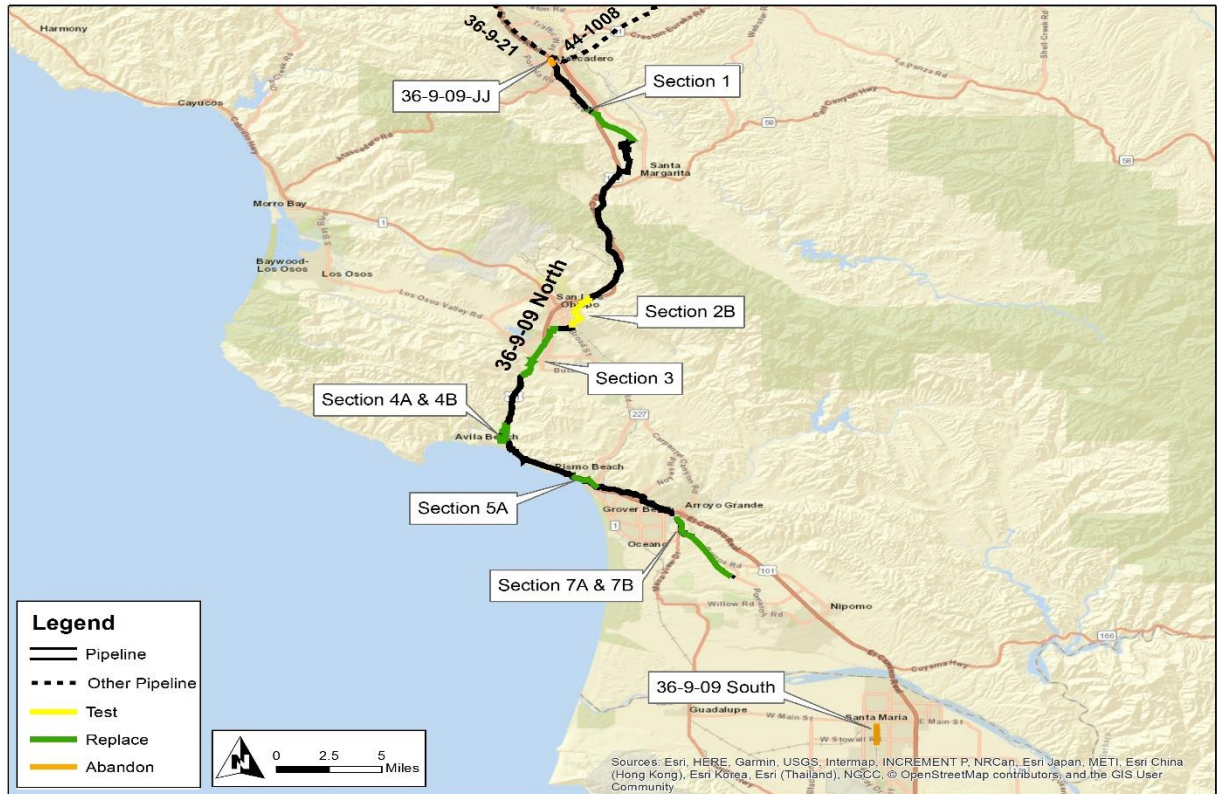

Pipeline Safety Enhancement Plan Final Report Supply Line 36-9-09 Section 4A and 4B Replacement Project

Figure 2: Satellite Image of Supply Line 36-9-09 North Section 4A and 4B Replacement Project

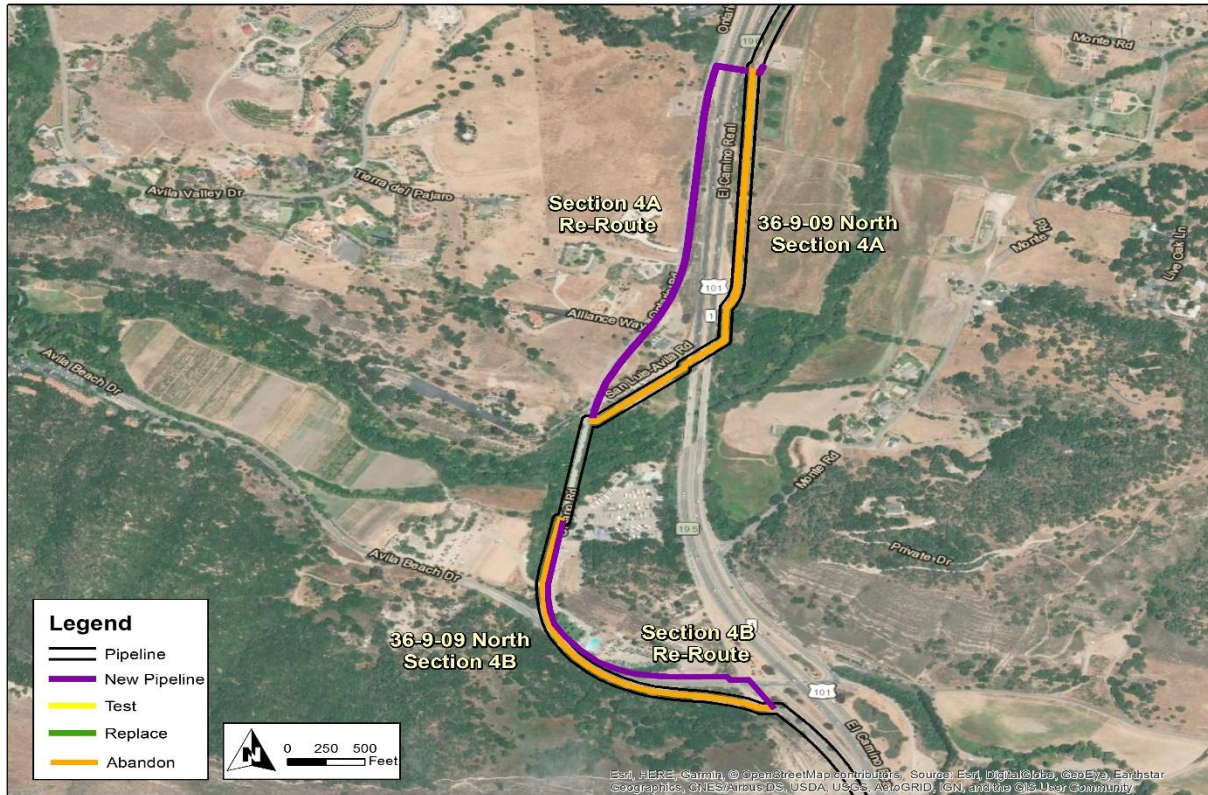

Pipeline Safety Enhancement Plan Final Report Supply Line 36-9-09 Section 4A and 4B Replacement Project

Figure 3: Overview Map of Supply Line 36-9-09 North Section 4A and 4B Replacement Project

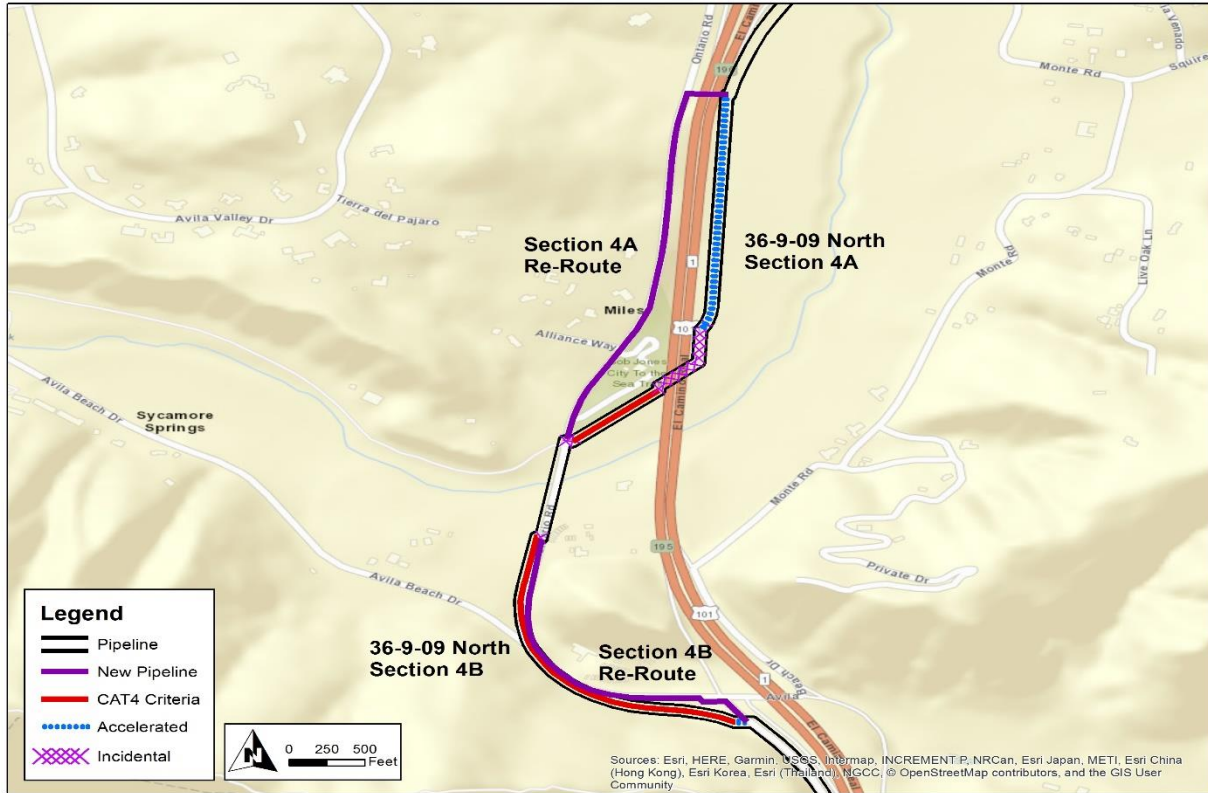

Pipeline Safety Enhancement Plan Final Report Supply Line 36-9-09 Section 4A and 4B Replacement Project

Figure 4: Satellite Image of Supply Line 36-9-09 North Section 4A Replacement Project

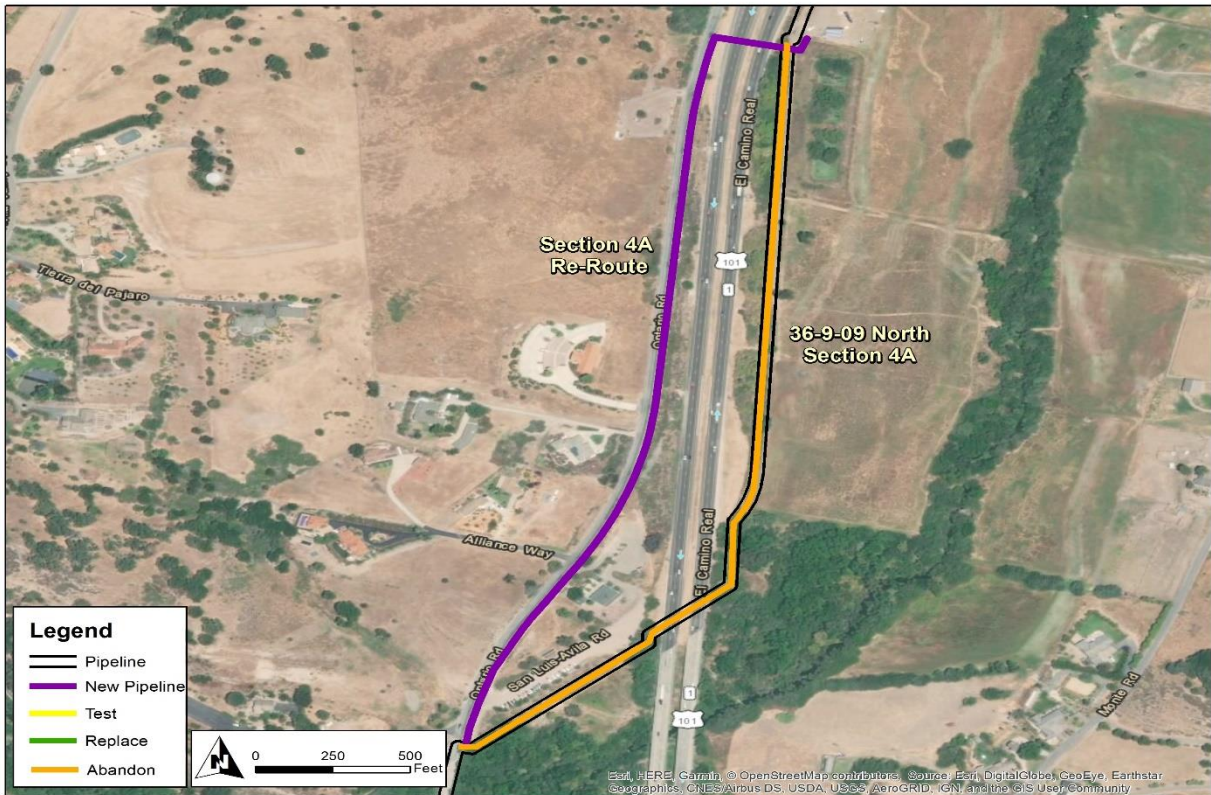

Pipeline Safety Enhancement Plan Final Report Supply Line 36-9-09 Section 4A and 4B Replacement Project

Figure 5: Overview Map of Supply Line 36-9-09 North Section 4A Replacement Project

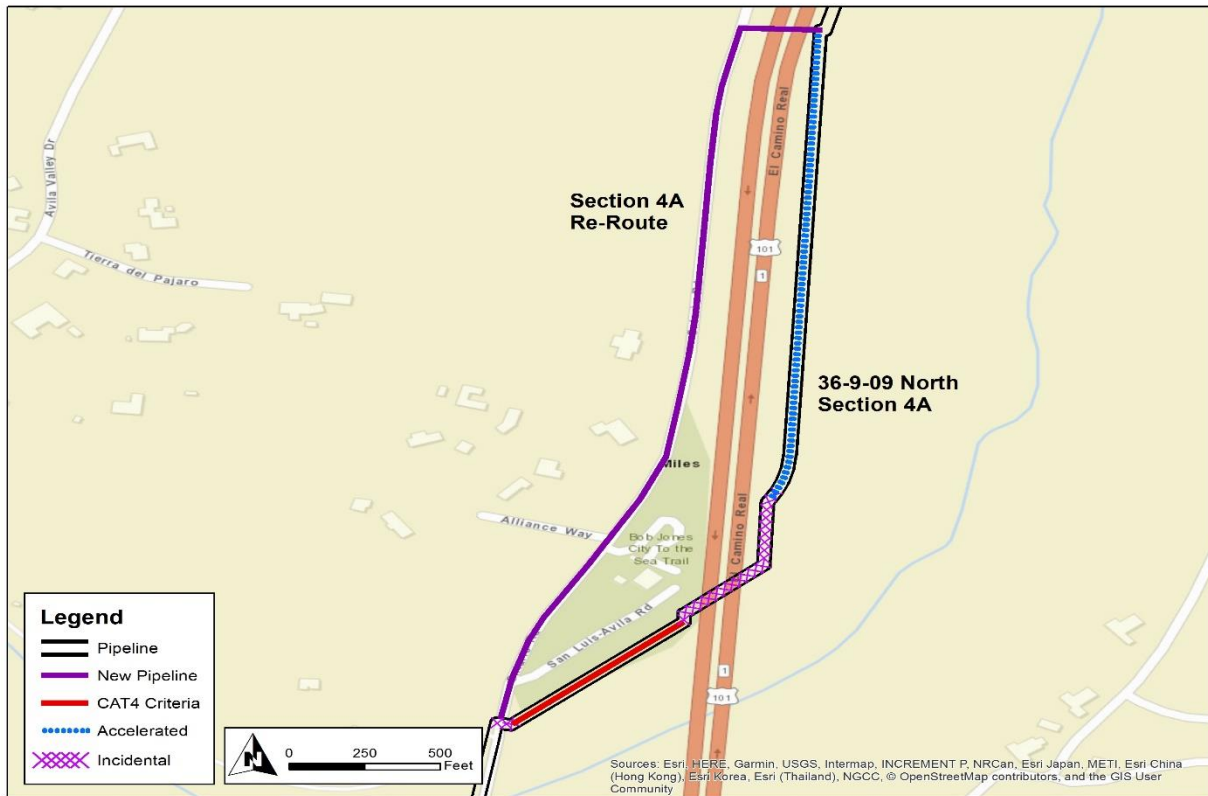

Pipeline Safety Enhancement Plan Final Report
Supply Line 36-9-09 Section 4A and 4B Replacement Project

Figure 6: Satellite Image of Supply Line 36-9-09 North Section 4B Replacement Project

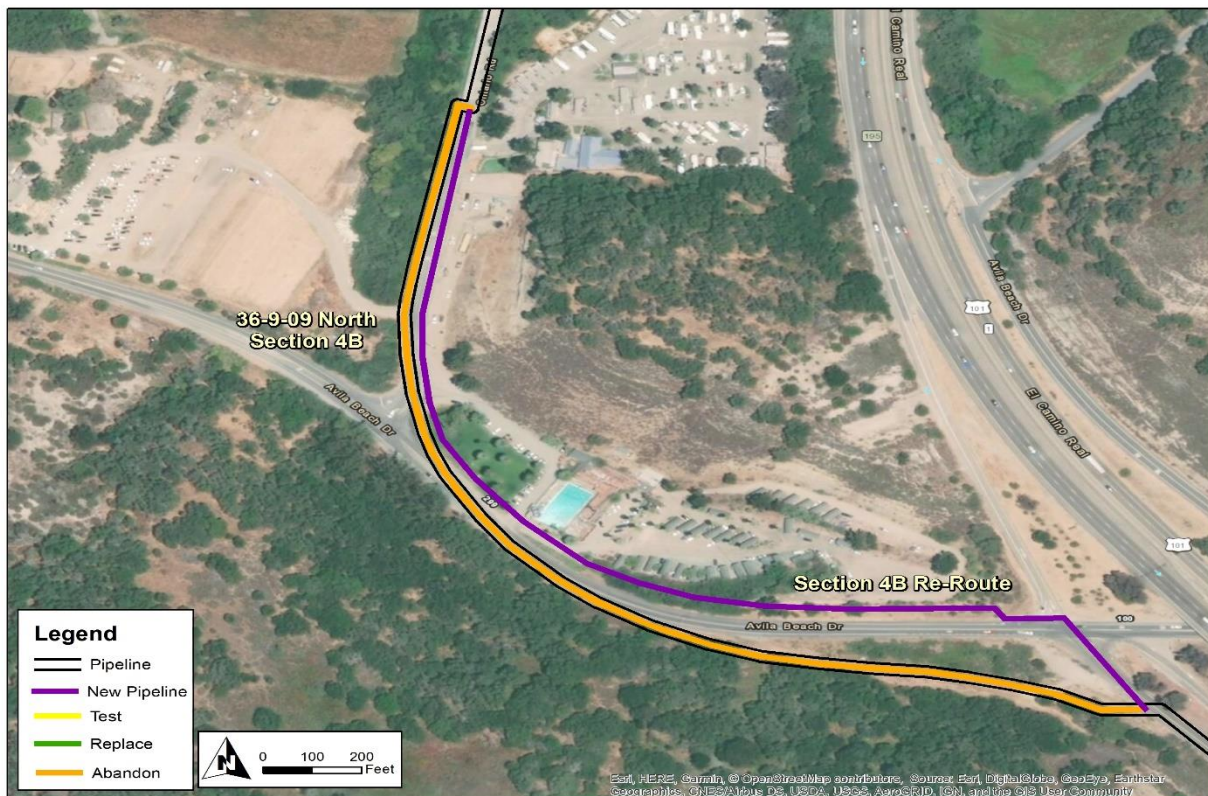

Pipeline Safety Enhancement Plan Final Report Supply Line 36-9-09 Section 4A and 4B Replacement Project

Figure 7: Overview Map of Supply Line 36-9-09 North Section 4B Replacement Project

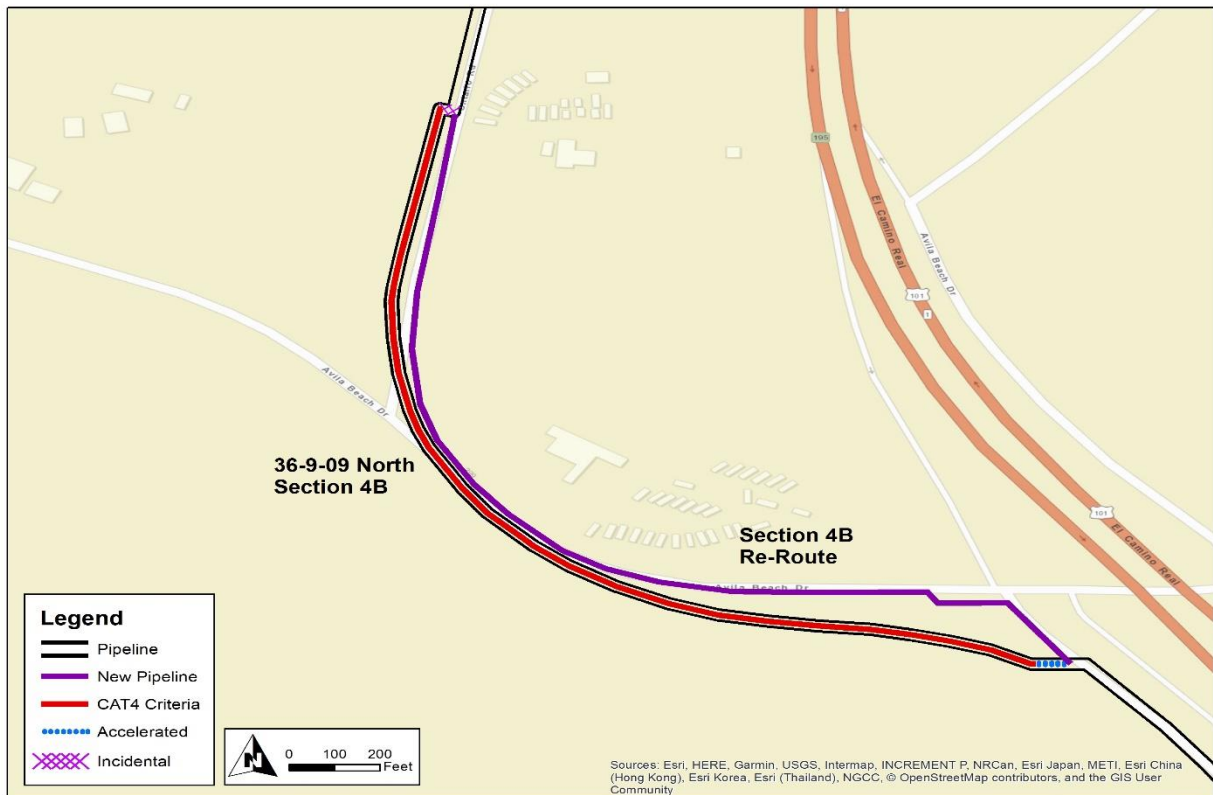

Pipeline Safety Enhancement Plan Final Report
Supply Line 36-9-09 Section 4A and 4B Replacement Project

II. ENGINEERING, DESIGN, AND PLANNING

A. Project Scope

Table 2: Mileage Information

	Criteria	Accelerated ⁴	Incidental	New	Total ⁵
Final Mileage	0.523 mi.	0.358 mi.	0.128 mi.	0.025 mi.	1.034 mi.
	2,761 ft.	1,893 ft.	676 ft.	131 ft.	5,461 ft.

SoCalGas and SDG&E presented a conceptual project scope in workpapers supporting the 2011 PSEP filing. Prior to initiating execution of the Project in 2014, SoCalGas and SDG&E reviewed existing pipeline records to validate the scope of the Project. During the Engineering, Design, and Planning phase, SoCalGas and SDG&E further refined the scope. This progression of the project scope is summarized as follows:

1. 2011 PSEP Filing: SoCalGas and SDG&E identified Supply Line 36-9-09 North as a Phase 1A Replacement Project comprised of 9.662 miles of Category 4 Criteria pipe and 6.354 miles of Accelerated pipe. Supply Line 36-9-09 North Section 4A and 4B are sections within that proposed project.
2. Scope Validation: Through scope validation activities, after the 2011 filing and before initiating execution of the Project, SoCalGas and SDG&E successfully reduced the scope of the Project by 9.139 miles of Category 4 Criteria pipe.

⁴ Accelerated mileage includes Phase 1B and Phase 2B pipe. Phase 2B includes pipelines without record of a pressure test to modern – Subpart J – standards (Phase 2B). The Accelerated mileage was included to realize efficiencies and to enhance project constructability.

⁵ Values may not add to total due to rounding.

Pipeline Safety Enhancement Plan Final Report
Supply Line 36-9-09 Section 4A and 4B Replacement Project

3. Engineering, Design, and Constructability:

- a. The Project included a reroute within city and county franchise to improve accessibility for routine maintenance and emergency response. To limit the impacts, the route selected was located in the franchised roadway, outside of culturally sensitive areas and private property identified along the existing route.
- b. The existing alignment was no longer easily accessible due to the development of homes, businesses, and Caltrans right of way (ROW) for Highway 101 since the original installation.
- c. The Project Team decided to split the execution of the Supply Line 36-9-09 North Section 4 Replacement Project into two sections when they encountered delays gaining access to a private property to design a section under Highway 101 using horizontal directional drill (HDD) prior to the application of long lead permits from Caltrans.
- d. The scope of Section 4A is a rerouted half mile replacement project that runs along Ontario Road, parallel to Highway 101, with a section that crosses under the highway using HDD.
- e. The scope of Section 4B is south of Section 4A and is another half mile replacement project. Section 4B would be prioritized since permits for the construction of this project could be obtained through San Luis Obispo County for installation within county franchise.
- f. Accelerated pipe was included to reroute the replacement along county franchise and removed from the existing Caltrans ROW. Incidental mileage was included because it was located between Category 4 Criteria and Accelerated segments and to facilitate abandonment of the existing pipeline.

Pipeline Safety Enhancement Plan Final Report
Supply Line 36-9-09 Section 4A and 4B Replacement Project

4. Final Project Scope: The final project scope consists of a 1.034 mile replacement. The Accelerated mileage consists of 0.337 miles of Phase 1B pipe, 114 feet of Phase 2B pipe and 676 feet of Incidental pipe.

B. Decision Tree Analysis

SoCalGas and SDG&E performed a PSEP Decision Tree analysis of Supply Line 36-9-09 North Section 4A and 4B and confirmed the project design should commence as a Replacement Project.

Pipeline segments installed prior to 1946 that are not capable of being assessed using in-line inspection technology are identified for replacement under the approved PSEP Decision Tree. As explained in the testimony supporting the approved PSEP, as part of the work previously completed during implementation federal gas transmission pipeline integrity management regulations (49 CFR 192, Subpart O), SoCalGas and SDG&E have already identified, retrofitted and in-line inspected pre-1946 transmission pipelines that were constructed using acceptable welding techniques and are operationally suited to in-line inspection. The remaining pre-1946 segments in the SoCalGas/SDG&E system are not suited for in-line inspection, likely have non-state-of-the-art welds, and would require significant investment for retrofitting to accommodate in-line inspection tools. Accordingly, consistent with the Commission's directive in D.11-06-017 to "address retrofitting pipeline to allow for inline inspection tools," the requirement in California Public Utilities Code section 958 that upon completion of the PSEP, where warranted, pipelines are to be capable of accommodating in-line inspection devices, and the overarching objectives of PSEP to enhance the safety of the pipeline system in a proactive, cost effective manner, the approved PSEP Decision Tree identifies pre-1946 non-piggable pipeline segments for abandonment and/or replacement.

Pipeline Safety Enhancement Plan Final Report Supply Line 36-9-09 Section 4A and 4B Replacement Project

Through this Decision Tree analysis, SoCalGas and SDG&E identified replacement as the more prudent option. Key considerations that support SoCalGas and SDG&E's determination to replace this segment include:

1. Shut-In Analysis: The Project Team completed a Request for Engineering Review (RER) analysis and concluded that this project should avoid shut-ins during normal and peak winter conditions. Three regulator stations cannot be shut-in and would require compressed natural gas (CNG) support along with two customer taps.
2. Piggability: Non-piggable.
3. Pipe Vintage: 1940.
4. Longseam Type: Unknown.
5. Longseam Repair History: No identified issues.
6. Condition of Coating: No identified issues.
7. History of Leaks: No identified issues.

Pipeline Safety Enhancement Plan Final Report
Supply Line 36-9-09 Section 4A and 4B Replacement Project

C. Engineering, Design, and Planning Factors

SoCalGas and SDG&E reviewed pipeline drawings and other information, contacted internal planning groups, communicated with external stakeholders, conducted survey activities, including reviewing public records and potholing of the area to confirm the presence of underground utilities and substructures, and completed a pre-design site walk. Key factors that influenced the engineering and design of the Project are as follows:

1. Reroute: The easement area had been developed since 1940, when the line was first installed, and is encumbered with homes, businesses, and a Caltrans ROW for Highway 101. The Project Team designed the replacement pipeline route along county franchise for accessibility and emergency response.
2. Diameter Changes: The Project Team replaced the existing [REDACTED] line with a [REDACTED] line based on the recommendation of the RER and to standardize the pipeline for future piggability purposes taking advantage of cost savings from favorable pricing of bulk purchased pipe.
3. Land Use:
 - a. For Section 4A, a new easement would be required for the north tie-in location.
 - b. The Project Team would obtain a Temporary Right of Entry (TRE) to gain access to private property for potholing and geotechnical evaluation to complete the design of the HDD crossing.
 - c. For Section 4A, the laydown yard was unusable during the rainy season and construction had to be scheduled when dry conditions were most probable.

Pipeline Safety Enhancement Plan Final Report
Supply Line 36-9-09 Section 4A and 4B Replacement Project

4. Constructability: Section 4A would utilize a HDD installation for crossing beneath Highway 101. The HDD equipment would be staged on the west side of the highway and the pipe pulled in from the north-east laydown yard.
5. Environmental: For Section 4A, SoCalGas and SDG&E requested an environmental analysis that indicated the potential for impacts to an adjacent coastal oak woodland. The Project Team confirmed a riparian zone at the entrance to the north-east laydown yard, that was designated as the HDD pullback location, and a seasonal wetland at the west location. Construction activity would be restricted from encroaching within the environmentally sensitive areas.
6. Permit Conditions: For Section 4A, Caltrans encroachment permit work hours were 8:30am to 4:00pm unless stated otherwise for traffic control. All shoulder closures on Highway 101 would be performed from 9:00am to 4:00pm and on Friday from 9:00am to 2:00pm.
7. Customer Impact: In addition to the CNG support described above, the Section 4A project would have no new taps installed within the project scope. Section 4B would have one tap transferred from the old line to the new line.
8. Community Impacts: Traffic control would be required during construction activity along Ontario Road so that local businesses remained open and ingress and egress roads remained accessible during working hours.
9. Known Substructures: The Project Team identified multiple utilities along the proposed pipeline route.

Pipeline Safety Enhancement Plan Final Report
Supply Line 36-9-09 Section 4A and 4B Replacement Project

D. Scope Changes

Through engineering, design, and planning activities, SoCalGas and SDG&E determined that changes in scope were appropriate to enhance the design of the Project and address engineering factors. As a result, the preliminary cost estimate does not fully reflect the final scope. After the preliminary cost estimate was developed and approved, the Project was split into two sections in order to begin construction as soon as practicable on Section 4B. Construction on Section 4A was delayed while obtaining a TRE to access land to plan a Caltrans crossing across Highway 101 in addition to the typical long lead permitting review time provided by Caltrans.

Pipeline Safety Enhancement Plan Final Report
Supply Line 36-9-09 Section 4A and 4B Replacement Project

III. CONSTRUCTION

A. Construction Contractor Selection

The Project Team prepared an initial cost estimate based on the preliminary design for Sections 4A and 4B. Following completion of the engineering, design, and planning activities described above, the Project Team evaluated the scope of the projects and determined to execute construction of Section 4A by utilizing competitive bids while executing Section 4B through the Performance Partner. The Project Team awarded Section 4A to the successful bidder.

1. SoCalGas and SDG&E's Preliminary Construction Cost Estimate (*confidential*):
SoCalGas and SDG&E's preliminary cost estimate for construction of both Sections 4A and 4B was [REDACTED].
2. Construction Contractor's Estimate (*confidential*): The Construction Contractor's bid for the Supply Line 36-9-09 North Section 4A and the Performance Partners estimate for the Supply Line 36-9-09 North Section 4B resulted in a total cost for both sections of [REDACTED], that was [REDACTED] than SoCalGas and SDG&E's preliminary cost estimate for construction.

Pipeline Safety Enhancement Plan Final Report
Supply Line 36-9-09 Section 4A and 4B Replacement Project

B. Construction Schedule

Table 3: Construction Timeline

Section 4A	
Construction Start Date	05/30/2017
Construction Completion Date	08/03/2017
NOP Date	07/21/2017
Section 4B	
Construction Start Date	09/15/2014
Construction Completion Date	01/09/2015
NOP Date	12/11/2014

As discussed in Section II - Engineering, Design, and Constructability: Project Scope, a delay between the two construction schedules was due to permitting and land acquisitions.

C. Changes During Construction

The conditions summarized below were encountered during construction. Activities to address or mitigate these conditions resulted in approximately \$293,000 for Section 4A and \$1.2 M for Section 4B in change orders.

Section 4A

1. Constructability Issues: The Construction Contractor encountered solid rock within the trench of the planned route. As a result, the Construction Contractor ordered rock teeth and hoe rams to break the solid rock. Work to remove the solid rock took five days.

Pipeline Safety Enhancement Plan Final Report
Supply Line 36-9-09 Section 4A and 4B Replacement Project

2. Field Design Change / Tie-In: The Project Team removed a pressure control fitting at the south tie-in where an existing weld on a previously installed weld needed to be examined and quality verified.

Section 4B

1. Constructability Issues:
 - a. The Construction Contractor encountered an underground water table at 40-inches below-grade on the path of excavation and pipe installation. Approximately 500 feet of trench was excavated and found to contain oil contaminated groundwater. Removal of the groundwater and soil was required. Costs were incurred for additional vacuum trucks, water tanks, shoring, base rock, and labor.
 - b. The Construction Contractor encountered solid rock within the trench of the planned route. As a result, the Construction Contractor ordered rock-breaking equipment that included an excavator, trucks, and backhoe with a grinder attachment.
2. Schedule Delay: Due to the multiple unknown substructures that caused alignment changes and unforeseen conditions such as excess groundwater and rock within the trench, personnel and equipment were on site for an additional seven weeks. Field overheads (fixed costs) were also extended to support the completion of this project.
3. Site Preparation: The laydown yard on Prado Road required additional soil stabilization. The City requested that the Project Team provide additional gravel, equipment, and labor to stabilize the ground at the laydown yard.

Pipeline Safety Enhancement Plan Final Report Supply Line 36-9-09 Section 4A and 4B Replacement Project

Figure 8: New Pipe Installation in Rocky Conditions



Pipeline Safety Enhancement Plan Final Report
Supply Line 36-9-09 Section 4A and 4B Replacement Project

Figure 9: Rock Breaker



Pipeline Safety Enhancement Plan Final Report Supply Line 36-9-09 Section 4A and 4B Replacement Project

Figure 10: Broken Rock for New Pipe Installation



Pipeline Safety Enhancement Plan Final Report Supply Line 36-9-09 Section 4A and 4B Replacement Project

D. Commissioning and Site Restoration

Commissioning activities include restoration of the site, final inspection and placement of the pipeline back into service, transportation and disposal of hydrotested water and hazardous material, and site demobilization. Closeout activities include development of final drawings, finalization of a reconciliation package, and updates to company recordkeeping systems to reflect the completed scope of work.

Pipeline Safety Enhancement Plan Final Report
Supply Line 36-9-09 Section 4A and 4B Replacement Project

IV. PROJECT COSTS

A. Cost Avoidance Actions

SoCalGas and SDG&E exercised due diligence in the planning, design, and construction activities for this project to minimize or avoid costs when prudent to do so. As discussed above, the Project Team conducted a site visit to identify and incorporate discernible site conditions into the engineering, design, and planning of the Project. Specific examples of cost avoidance actions taken on this project are:

1. Engineering and Design: The finalized route saved access road preparation costs that would have been incurred. The previous access road required costly road leveling and tree trimming. In addition, a parallel route would have incurred costs for permitting and other restrictions.
2. Materials: Bulk ordered pipe provided volume pricing for the [REDACTED] pipe.

B. Cost Estimate

Based on the preliminary design, once the project scope was confirmed and engineering, design, and planning activities were underway, SoCalGas and SDG&E prepared an estimate of the Direct Costs of the Project in the amount of \$6,409,098. This estimate was prepared in May of 2014, using the “Stage 3 SCG Pipeline Estimate Template Rev 0” estimating tool, the most current version of the PSEP Estimate Template at the time. The Project Team considered the conditions known at the time to prepare the preliminary Direct Cost estimate. This estimate reflects the projected Labor, Material, and Services costs anticipated to be incurred to execute the Project.

SoCalGas and SDG&E estimated Indirect Costs of the Project based on the estimated Direct Costs and other project-related variables.

Pipeline Safety Enhancement Plan Final Report
Supply Line 36-9-09 Section 4A and 4B Replacement Project

C. Actual Direct and Indirect Costs

Actual Direct Costs reflect the Labor, Material, and Service costs incurred to execute the Project. Actual Indirect Costs reflect costs for incremental overhead loaders in accordance with Company overhead allocation policies. The total loaded cost of the Project is \$15,145,332.

Table 4: Estimated and Actual Direct Costs and Variances

Direct Costs (\$)	Estimate	Actuals	Delta Over/(Under)
Company Labor	212,261	321,992	109,731
Materials	299,146	288,001	(11,145)
Construction Contractor	3,572,435	5,928,262	2,355,827
Construction Management & Support	209,000	1,782,769	1,573,769
Environmental	141,350	778,597	637,247
Engineering & Design	952,867	1,756,791	803,924
Project Management & Services	208,965	419,993	211,028
ROW & Permits	135,689	270,891	135,202
GMA	677,385	1,499,260	821,875
Total Direct Costs	6,409,098	13,046,556	6,637,458

Pipeline Safety Enhancement Plan Final Report
Supply Line 36-9-09 Section 4A and 4B Replacement Project

Table 5: Estimated and Actual Indirect Costs, Total Costs, and Variances

Indirect Costs/Total Costs (\$)	Estimate	Actuals	Delta Over/(Under)
Overheads	622,688	999,323	376,635
AFUDC	143,087	985,087	842,000
Property Taxes	26,332	114,366	88,034
Total Indirect Costs	792,107	2,098,776	1,306,669
Total Direct Costs	6,409,098	13,046,556	6,637,458
Total Loaded Costs	7,201,205	15,145,332	7,944,127

D. Disallowance

There was no disallowance for Supply Line 36-9-09 North Section 4A and Section 4B as there were no post-1955 segments included in the Project without records that provide the minimum information to demonstrate compliance with then applicable industry standards or regulatory strength testing and recordkeeping requirements.

Pipeline Safety Enhancement Plan Final Report
Supply Line 36-9-09 Section 4A and 4B Replacement Project

V. CONCLUSION

SoCalGas and SDG&E enhanced the safety of their integrated natural gas transmission system by prudently executing the Supply Line 36-9-09 North Section 4A and 4B Replacement Project. Through this Replacement Project, SoCalGas and SDG&E successfully replaced and rerouted 1.034 miles of pipe in City of Avila Beach. The total loaded cost of the Project is \$15,145,332.

SoCalGas and SDG&E executed this project prudently by executing a complex project that required restricted hours; responding prudently to unknown conditions from misidentified and unidentified substructures, rocky soil conditions that required additional rock breaking equipment; and prudently addressing delays and unanticipated field changes (contaminated ground water).

SoCalGas and SDG&E engaged in prudent cost avoidance efforts by engaging in reasonable efforts to promote competitive and market-based rates for contractor services and materials and used a reasonable amount of company and contractor resources given the complexity of this project.

**End of Supply Line 36-9-09 North Section 4A and 4B Replacement
Project Final Report**

Pipeline Safety Enhancement Plan Final Report
Supply Line 36-9-09 Section 7A and 7B Replacement Project

I. SUPPLY LINE 36-9-09 NORTH SECTION 7A AND 7B REPLACEMENT PROJECT

A. Background and Summary

Supply Line 36-9-09 North Section 7A and 7B Replacement Project is a [REDACTED] diameter transmission pipeline that runs approximately 3.8 miles that was rerouted through the City of Arroyo Grande and San Luis Obispo County. The pipeline is primarily routed across a Class 3 location. This report describes the activities associated with the Supply Line 36-9-09 North Section 7A and Section 7B Replacement Project, which consists of the replacement and rerouting of 4.26 miles of pipeline, installation of a new regulator station and a 0.272-mile lateral connection. The specific attributes of the Project are summarized in Table 1 below. The total loaded cost of the Project is \$37,744,598.

The Supply Line 36-9-09 North Section 7A and 7B Replacement Project is a component of Supply Line 36-9-09-North, and was identified in the 2011 PSEP filing¹ as a 16.016-mile replacement project. The pipeline traverses the cities of Atascadero, San Luis Obispo, Pismo Beach, and Arroyo Grande and is primarily routed across a Class 3 location. For project manageability purposes and due to unique characteristics related to non-contiguous portions of the pipeline, SoCalGas and SDG&E divided Supply Line-36-9-09 North into several project sections to be managed separately (see Figure 1). Two key reasons drove the decision to manage the work on Supply Line 36-9-09 North in this manner; the sections were in different locations and physically separated from each other by non-PSEP segments of pipeline. Additionally, project scopes

¹ See Amended PSEP of SoCalGas and SDG&E, submitted December 2, 2011, in R.11-02-019 and subsequently transferred to A.11-11-002.

Pipeline Safety Enhancement Plan Final Report
Supply Line 36-9-09 Section 7A and 7B Replacement Project

(hydrotesting, replacement or abandonment) differed among the sections, which drove differing permit acquisition timelines.

Table 1: General Project Information

Project Name		Supply Line 36-9-09 North Section 7A		
Project Type	Replacement			
Length	1.073 miles			
Location	Arroyo Grande			
Class	3			
MAOP (<i>confidential</i>)	[REDACTED]			
Pipe Vintage	1932			
Construction Start	09/06/2016			
Construction Finish	12/23/2016			
Original Pipe Diameter (<i>confidential</i>)	[REDACTED]			
New Diameter (<i>confidential</i>)	[REDACTED]			
Original SMYS ² (<i>confidential</i>)	[REDACTED]			
New SMYS (<i>confidential</i>)	[REDACTED]			
Project Name		Supply Line 36-9-09 North Section 7B		
Project Type	Replacement			
Length	3.186 miles			
Location	Arroyo Grande			
Class	3			
MAOP (<i>confidential</i>)	[REDACTED]			
Pipe Vintage	1932			
Construction Start	05/18/2015			
Construction Finish	12/18/2015			
Original Pipe Diameter (<i>confidential</i>)	[REDACTED]			
New Diameter (<i>confidential</i>)	[REDACTED]			
Original SMYS ³ (<i>confidential</i>)	[REDACTED]			
New SMYS (<i>confidential</i>)	[REDACTED]			
Project Costs (\$)		Capital	O&M	Total
Loaded Project Costs		37,729,254	15,344	37,744,598
Disallowed Costs		-	-	-

² Highest percentage of Specified Minimum Yield Strength (SMYS) of Category 4 Criteria pipe.

³ Ibid.

Pipeline Safety Enhancement Plan Final Report
Supply Line 36-9-09 Section 7A and 7B Replacement Project

Maps and Images

Figure 1: Map of Supply Line 36-9-09 North PSEP Projects



Pipeline Safety Enhancement Plan Final Report Supply Line 36-9-09 Section 7A and 7B Replacement Project

Figure 2: Satellite Image of Supply Line 36-9-09 Section 7A and 7B Replacement Project

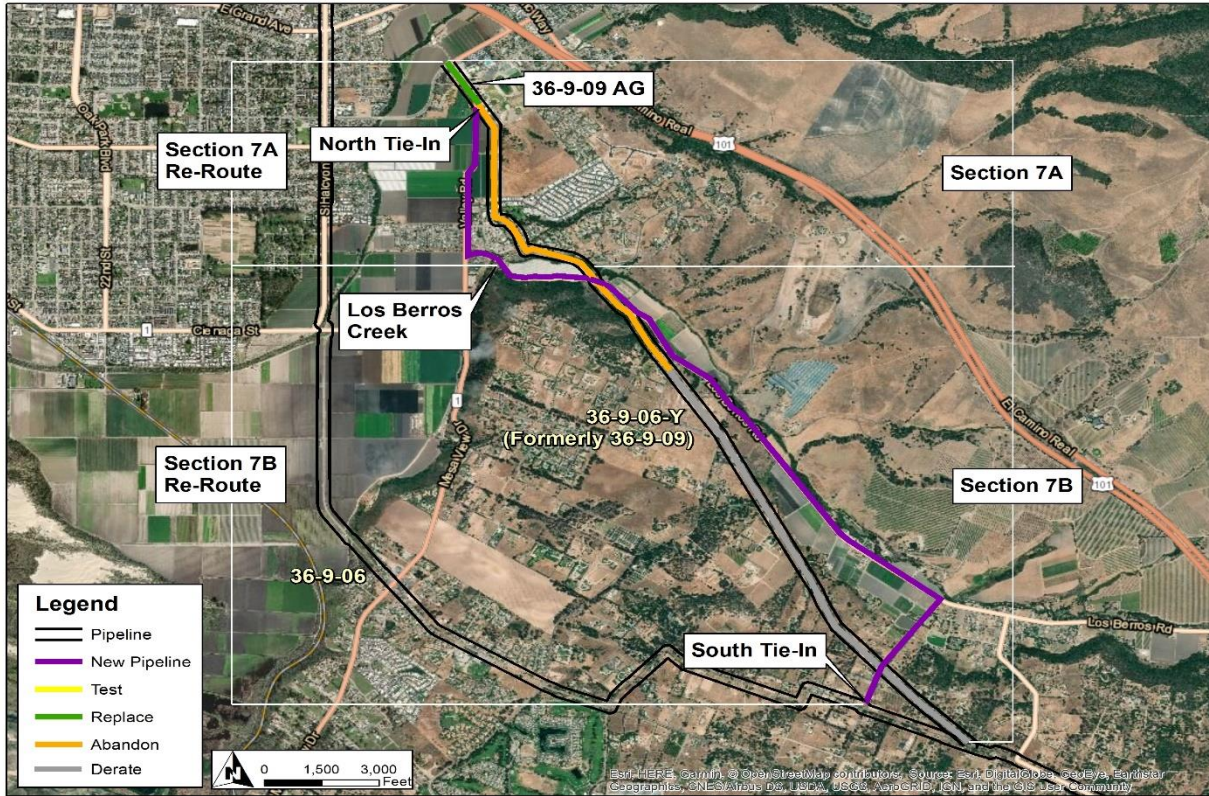

Pipeline Safety Enhancement Plan Final Report Supply Line 36-9-09 Section 7A and 7B Replacement Project

Figure 3: Overview Map of Supply Line 36-9-09 Section 7A and 7B Replacement Project

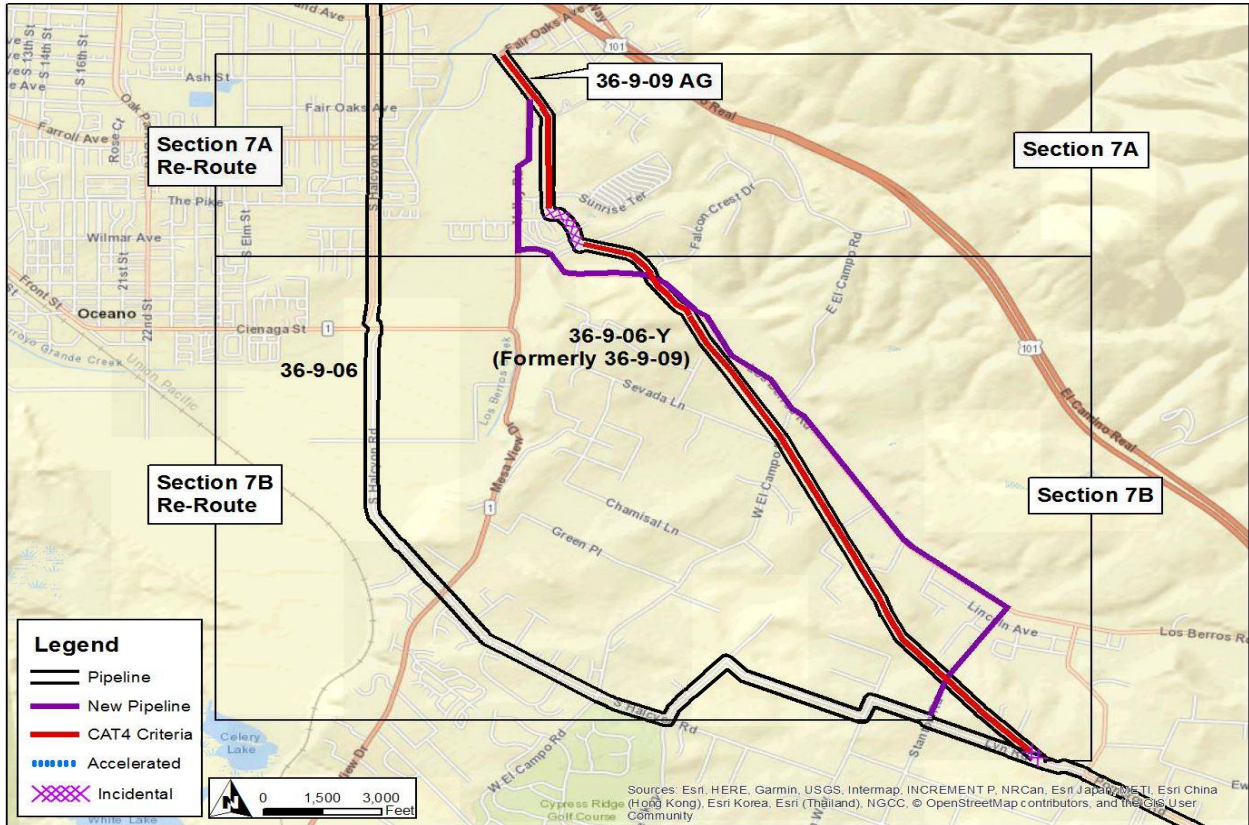

Pipeline Safety Enhancement Plan Final Report Supply Line 36-9-09 Section 7A and 7B Replacement Project

Figure 4: Satellite Image of Supply Line 36-9-09 Section 7A Replacement Project

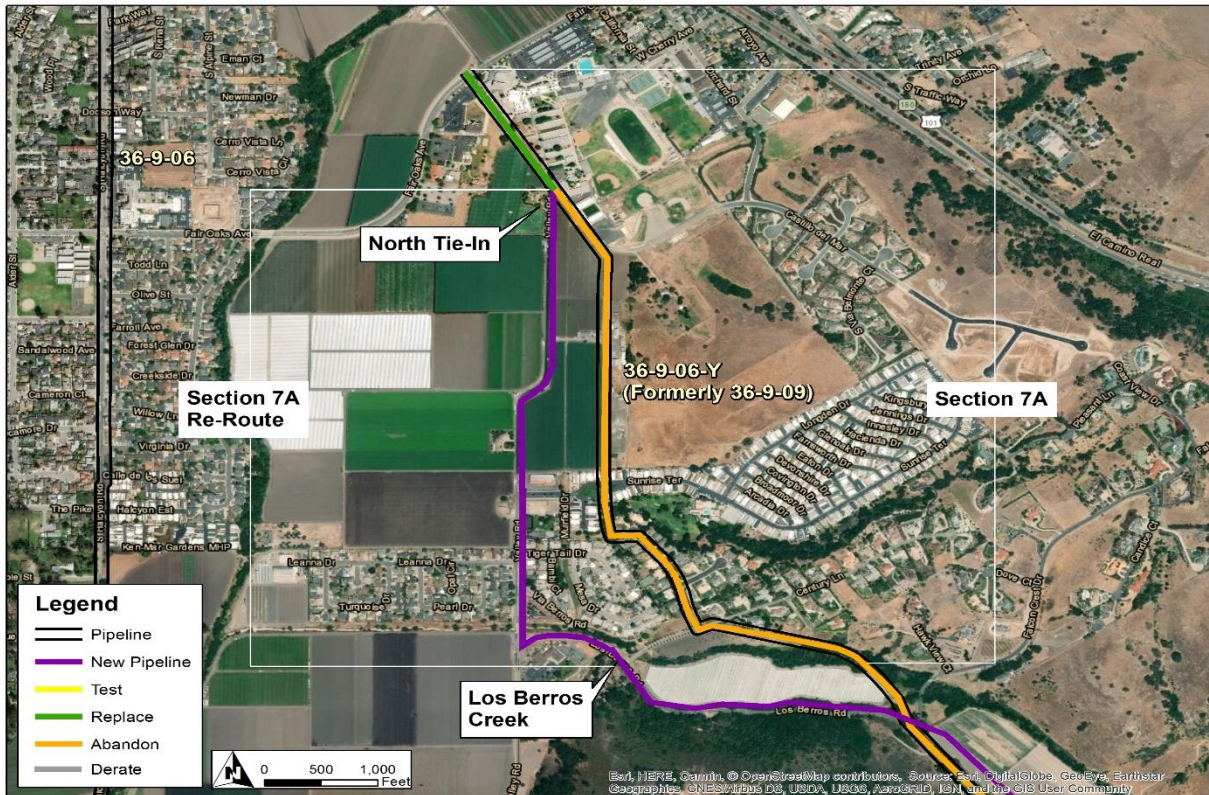

Pipeline Safety Enhancement Plan Final Report
Supply Line 36-9-09 Section 7A and 7B Replacement Project

Figure 5: Overview Map of Supply Line 36-9-09 Section 7A Replacement Project

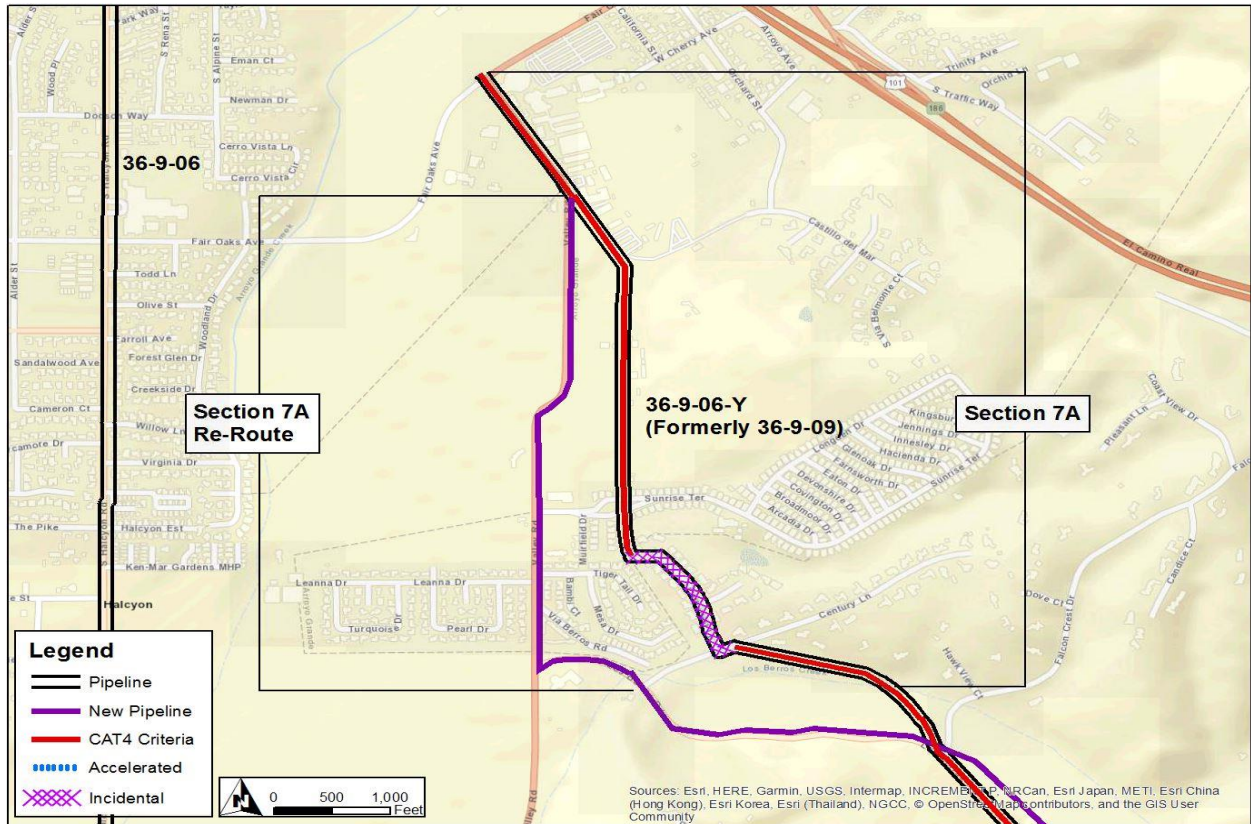

Pipeline Safety Enhancement Plan Final Report Supply Line 36-9-09 Section 7A and 7B Replacement Project

Figure 6: Satellite Image of Supply Line 36-9-09 North Section 7B Replacement Project

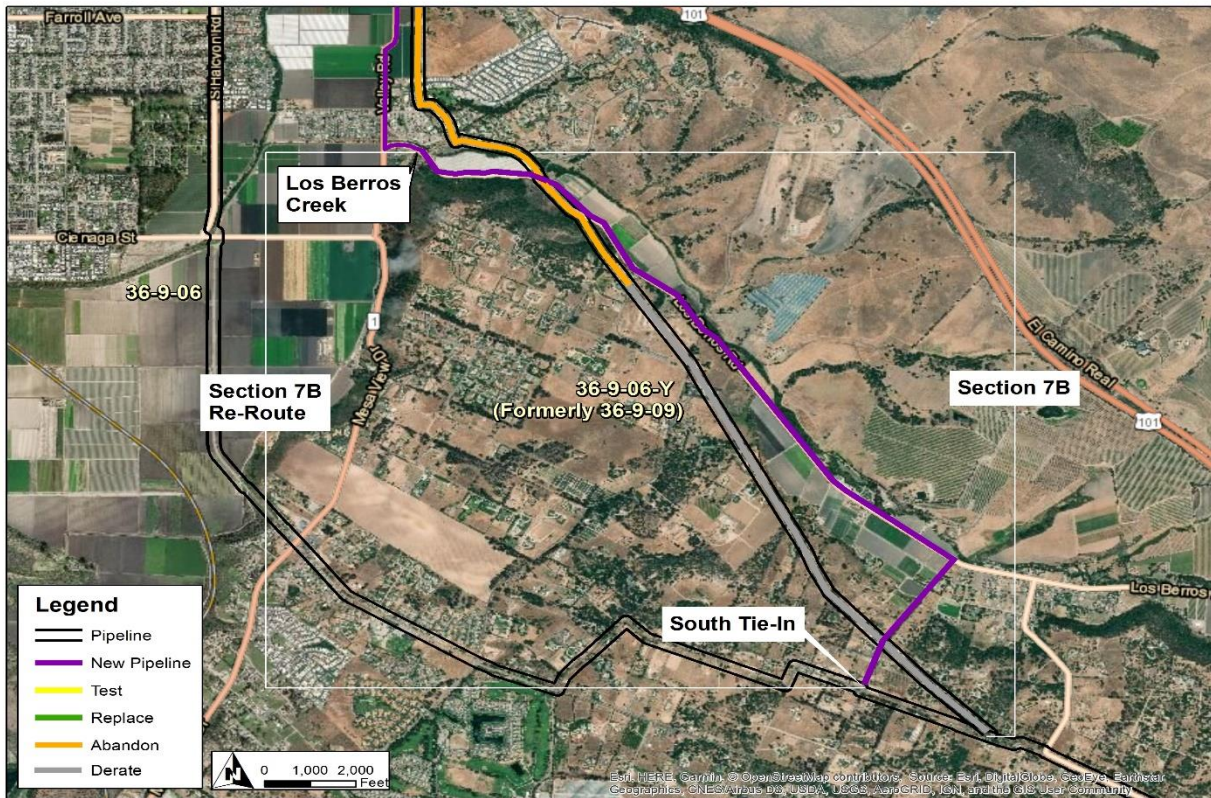

Pipeline Safety Enhancement Plan Final Report Supply Line 36-9-09 Section 7A and 7B Replacement Project

Figure 7: Overview Map of Supply Line 36-9-09 North Section 7B Replacement Project

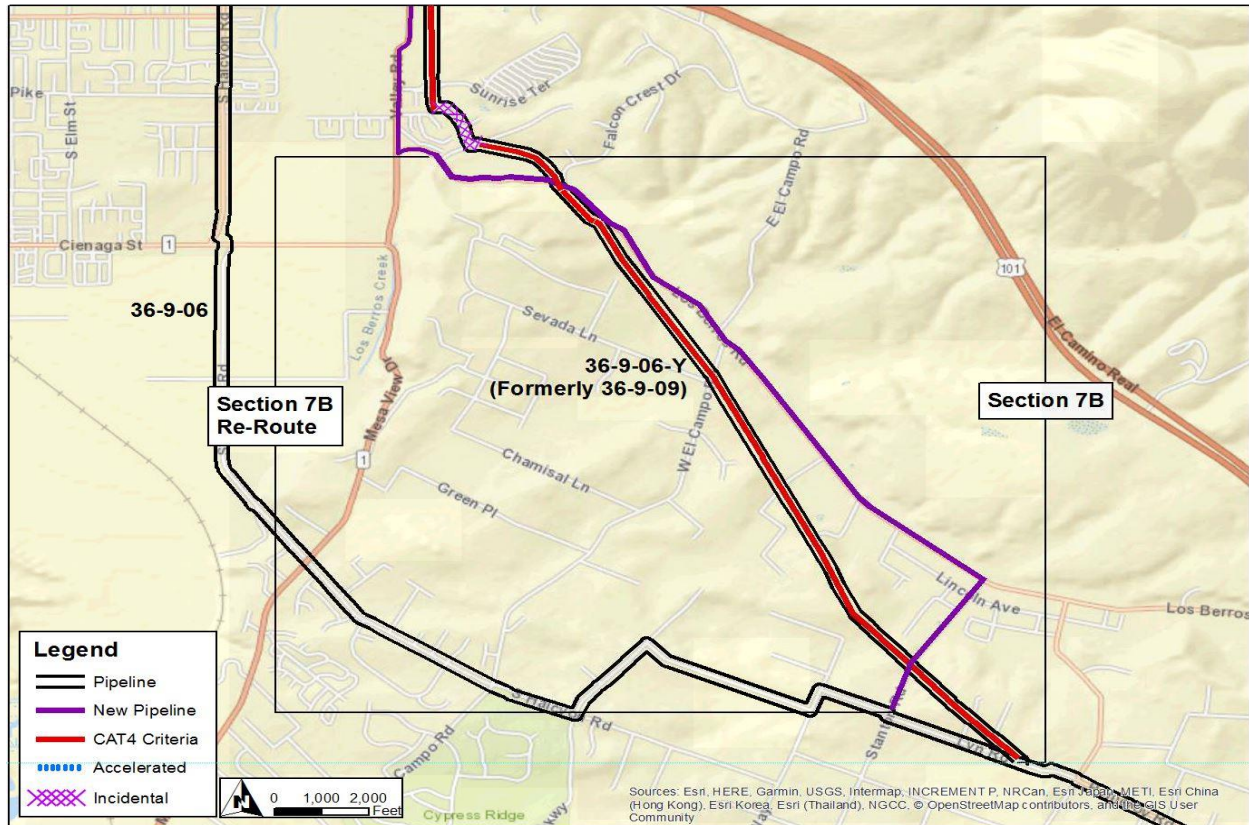

Pipeline Safety Enhancement Plan Final Report
Supply Line 36-9-09 Section 7A and 7B Replacement Project

Figure 8: Schematic of Supply Line 36-9-09 North Section 7A North Tie-In

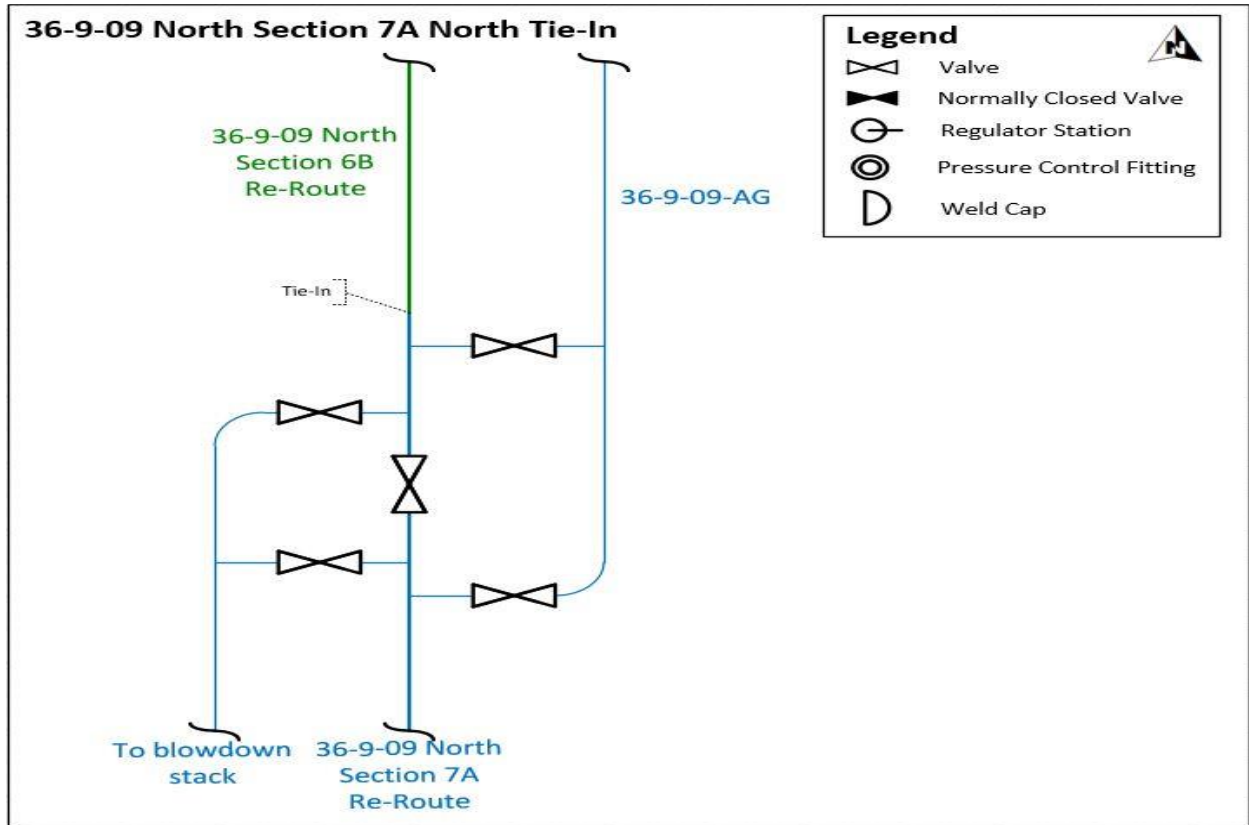

Pipeline Safety Enhancement Plan Final Report
Supply Line 36-9-09 Section 7A and 7B Replacement Project

Figure 9: Schematic of Supply Line 36-9-09 North Section 7B South Tie-In

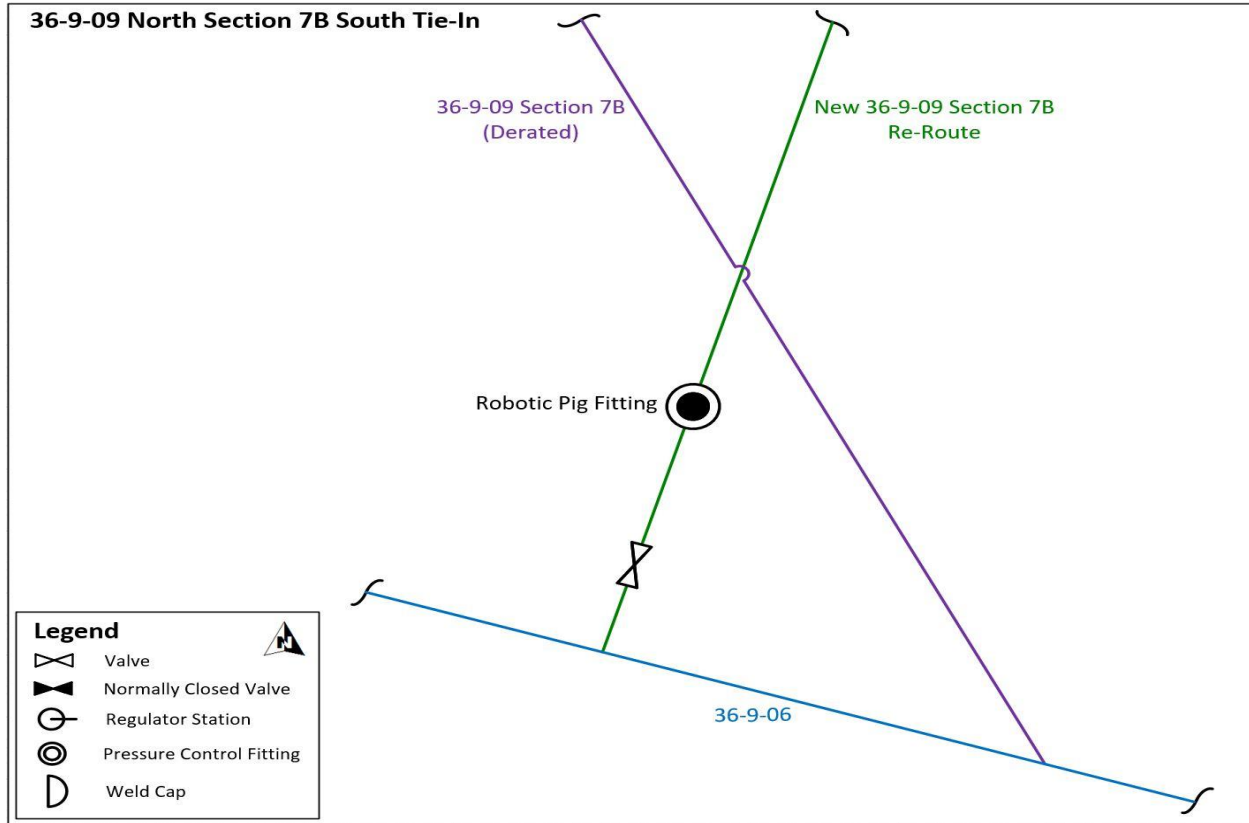

Pipeline Safety Enhancement Plan Final Report
Supply Line 36-9-09 Section 7A and 7B Replacement Project

II. ENGINEERING, DESIGN, AND PLANNING

A. Project Scope

Table 2: Mileage Information

	Criteria	Accelerated	Incidental	New	Total ⁴
Final Mileage	3.515 mi.	0 mi.	0.241 mi.	0.504 mi.	4.260 mi.
	18,558 ft.	0 ft.	1,274 ft.	2,660 ft.	22,492 ft.

SoCalGas and SDG&E presented a conceptual project scope in workpapers supporting the 2011 PSEP filing. Prior to initiating execution of the Project in 2015, SoCalGas and SDG&E reviewed existing pipeline records to validate the scope of the Project. During the Engineering, Design, and Planning phase, SoCalGas and SDG&E further refined the scope. This progression of the project scope is summarized as follows:

1. 2011 PSEP Filing: SoCalGas and SDG&E identified Supply Line 36-9-09 North as a Phase 1A Replacement project comprised of 9.662 miles of Category 4 Criteria pipe and 6.354 miles of Accelerated pipe. Supply Line 36-9-09 Section 7A and 7B are sections within that project.
2. Scope Validation: Due to the unique characteristics of the non-contiguous portions of the Project, SoCalGas and SDG&E successfully reduced the scope of the Project by 6.147 miles of Category 4 Criteria pipe.
3. Engineering, Design, and Constructability:
 - a. The Project included a reroute along El Camino Real within city and county franchise to improve accessibility for routine maintenance and emergency response. The existing alignment was no longer easily accessible due to the development of homes and businesses following the original installation. The

⁴ Values may not add to total due to rounding.

Pipeline Safety Enhancement Plan Final Report
Supply Line 36-9-09 Section 7A and 7B Replacement Project

reroute also realigned pipeline segments from culturally sensitive areas identified along the existing route.

- b. The Project team anticipated delays in obtaining the necessary permits and Temporary Right of Entry (TRE) for Supply Line 36-9-09 North Section 7 therefore, they split the Project into two sections, Section 7A and 7B. This split allowed for separate construction schedules and facilitated execution of this project as soon as practicable by mitigating the impact of permitting delays related to cultural and environmental sensitivities, and negotiation with a private landowner regarding a permanent easement.
 - c. Anticipated delays for completing construction of Supply Line 36-9-09 North Section 7A were due to a California Department Fish and Wildlife (CDFW) permit required for the crossing of Los Berros Creek and the potential of discovering archeological artifacts within the Project limits. Section 7A would also require a permanent easement in addition to the CDFW permit.
 - d. Supply Line 36-9-09 North Section 7B is south of Los Berros Creek running through rural and residential neighborhoods along city and county franchise. This section was not environmentally or culturally sensitive and it was determined that the necessary permits and Temporary Right of Entry (TRE) could be secured timely and construction could begin as scheduled.
 - e. Incidental mileage was included because it is situated along the pipeline between two Category 4 Criteria segments and facilitates the derating of the existing line.
4. Final Project Scope: The final project scope consists of a 4.260-mile replacement. The Incidental mileage consists of 0.241 miles of pipe.

Pipeline Safety Enhancement Plan Final Report
Supply Line 36-9-09 Section 7A and 7B Replacement Project

B. Decision Tree Analysis

SoCalGas and SDG&E performed a PSEP Decision Tree analysis of Supply Line 36-9-09 North Section 7A and 7B and confirmed the project design should commence as a Replacement Project.

Pipeline segments installed prior to 1946 that are not capable of being assessed using in-line inspection technology are identified for replacement under the approved PSEP Decision Tree. As explained in the testimony supporting the approved PSEP, as part of the work previously completed during implementation of federal gas transmission pipeline integrity management regulations (49 CFR 192, Subpart O), SoCalGas and SDG&E previously identified, retrofitted and in-line inspected pre-1946 transmission pipelines that were constructed using acceptable welding techniques and are operationally suited to in-line inspection. The remaining pre-1946 segments in the SoCalGas/SDG&E system are not suited for in-line inspection, likely have non-state-of-the-art welds, and would require significant investment for retrofitting to accommodate in-line inspection tools. Accordingly, consistent with the Commission's directive in D.11-06-017 to "address retrofitting pipeline to allow for inline inspection tools," the requirement in California Public Utilities Code section 958 that upon completion of the PSEP, where warranted, pipelines are to be capable of accommodating in-line inspection devices, and the overarching objectives of PSEP to enhance the safety of the pipeline system in a proactive, cost effective manner, the approved PSEP Decision Tree identifies pre-1946 non-piggable pipeline segments for abandonment and/or replacement.

Through this Decision Tree analysis, SoCalGas and SDG&E identified replacement as the more prudent option. Key considerations that support SoCalGas and SDG&E's determination to replace this segment include:

Pipeline Safety Enhancement Plan Final Report
Supply Line 36-9-09 Section 7A and 7B Replacement Project

1. Shut-In Analysis: The Project team completed a Request for Engineering Review (RER) analysis and concluded there was a risk to the system if there were any disruptions to service on adjacent Supply Line 36-9-06; therefore, it was essential that service from Supply Line 36-9-06 remain uninterrupted. The Project team concluded that customer impacts could be avoided if the existing line continued to provide service until the tie-in for the new line was completed.
2. Piggability: Non-piggable.
3. Existing Pipe Attributes: Multiple pipe diameters.
4. Pipe Vintage: 1932.
5. Longseam Type: Unknown.
6. Longseam Repair History: No identified issues.
7. Condition of Coating: No identified issues.
8. History of Leaks: No identified issues.

C. Engineering, Design, and Planning Factors

SoCalGas and SDG&E reviewed pipeline drawings and other information, contacted internal planning groups, communicated with external stakeholders, conducted survey activities, including reviewing public records and potholing of the area to confirm the presence of underground utilities and substructures, and completed a pre-design site walk. Key factors that influenced the engineering and design of the Project are as follows:

1. Reroute: The Project Team relocated Supply Line 36-9-09 North Section 7A and 7B to Los Berros Road from the existing easement within city and county franchise to improve accessibility for routine maintenance and emergency response. The

Pipeline Safety Enhancement Plan Final Report
Supply Line 36-9-09 Section 7A and 7B Replacement Project

reroute avoided obtaining new rights-of-way for multiple private property crossings. The existing alignment was no longer easily accessible in the private property section due to the development of homes and businesses following the original installation.

2. Diameter Changes: The Project team replaced the existing [REDACTED] line with a [REDACTED] line based on the recommendation of the RER, to standardize the pipeline for future pigability purposes and take advantage of cost savings from favorable pricing of bulk-purchased pipe.
3. Customer Impacts:
 - a. Customer impacts were avoided since the project plan called for the existing line to remain in service until the tie-in for the new line was completed. The existing pipeline (Section 7B) would then be derated to medium pressure and continue to provide service. The derated line was subsequently renamed Supply Line 36-9-06-Y.
 - b. Three existing customer taps on the high pressure line (Section 7A) would be tied over to an adjacent medium pressure line with no loss of service. No new taps were required to be installed.⁵
 - c. To facilitate the abandonment of the northern portion of the existing Supply Line 36-9-09 North Section 7A, a 0.272 mile [REDACTED] lateral needed to be installed to feed the new regulator station during construction of Section 7B. To complete the work, a valve bridal assembly was included in the design at the mainline valve (MLV) to tie in Section 7A and Section 6B.

⁵ The medium pressure conversion of the 37 existing taps in connection with this project is included in the scope of Supply Line 36-9-09 North Section 7A.

Pipeline Safety Enhancement Plan Final Report
Supply Line 36-9-09 Section 7A and 7B Replacement Project

4. Community Impacts:

- a. This Project route was aligned within available franchise space along Los Berros Road, a high traffic County roadway. Construction activity was anticipated to impact traffic and a local high school. The school requested that work be completed around the school schedule.
- b. Due to the narrow roadway along the alignment of Section 7B, San Luis Obispo County imposed encroachment permit conditions that limited work hours during lane closures and required road closures and detours for night work as a safety measure.

5. Environmental: As described above, the Project team decided to divide the Project into Sections 7A and 7B so that construction could begin on Section 7B first. Section 7A, would follow once the planning and permitting was resolved to accommodate the waterways and culturally sensitive areas. Key factors among the environmental and culturally sensitive issues considered and accommodated in the design and planning for this project are:

- a. Archaeological surveys revealed that 10% of the pipeline segments were within culturally sensitive areas. To limit the impacts, the route selected was located in the franchised roadway and outside of these sensitive areas.
- b. To complete the horizontal directional drilling (HDD) under Los Berros Creek, CDFW required construction to be completed prior to the "wet" season. This requirement is to ease mitigation efforts if there were to be an uncontrolled release of water since it would be difficult to mitigate issues if the creek bed was wet.

Pipeline Safety Enhancement Plan Final Report
Supply Line 36-9-09 Section 7A and 7B Replacement Project

6. Permit Conditions:

- a. Permits would be required from the Regional Water Quality Control Board (RWQCB) for the Storm Water Pollution Prevention Plan (SWPPP) and from San Luis Obispo County for an encroachment permit. The encroachment permit was granted with conditions that required restricted work hours with daytime closures on Los Berros Road and Valley Road allowed from 8:30 am to 3:00 pm.
- b. This Project, as part of the overall construction schedule for San Luis Obispo County, was planned in coordination with the Performance Partner to avoid conflicts with other PSEP or SoCalGas Operating District construction projects.

7. Land Use: Three staging areas were secured for the Project requiring TREs: 1) for prefabrication and material/equipment storage; 2) for the construction office trailers; and 3) for the facilitation of the hydrotest (*i.e.*, the staging of the water storage tanks and support equipment).

8. Known Substructures: Prior to construction, storm drains, water main, communication, electrical, and gas mains were identified and included in the project design.

9. Tie-In: A MLV and bridle assembly was designed for a future tie-in to Section 6B, which avoided an additional blowdown. This also kept in service a regulator station fed by a [REDACTED] lateral from the valve bridle.

D. Scope Changes

Through engineering, design, and planning activities, SoCalGas and SDG&E determined that changes in scope were appropriate to enhance the design of the Project and address engineering factors. As a result, the preliminary cost estimate does not fully reflect the final scope. Summarized below are notable changes in scope made after the preliminary cost estimate was developed and approved.

Pipeline Safety Enhancement Plan Final Report
Supply Line 36-9-09 Section 7A and 7B Replacement Project

1. Environmental: To avoid delaying the start of construction, the Project was split into two separate sections to address significant cultural archeological sites that were determined to be in the direct path of the proposed alignment.
2. Land Acquisition: A segment of Section 7A scope was deferred to the Supply Line 36-9-09 North Section 6B Replacement Project scope when land rights issues could not be resolved prior to construction.

Pipeline Safety Enhancement Plan Final Report
Supply Line 36-9-09 Section 7A and 7B Replacement Project

III. CONSTRUCTION

A. Construction Contractor Selection

The Project team prepared an initial cost estimate based on the preliminary design. Following completion of the engineering, design, and planning activities described above, the Project team directed the Performance Partner to prepare cost estimates based on a more detailed engineering design package, which included the updated design described in the discussion of notable Scope Changes above. SoCalGas and SDG&E awarded the construction contract to the Performance Partner.

Section 7A

1. SoCalGas and SDG&E's Preliminary Construction Cost Estimate (*confidential*):
SoCalGas and SDG&E's preliminary cost estimate for construction for Section 7A was [REDACTED].
2. Construction Contractor's Target Price Estimate (*confidential*): The Construction Contractor's cost estimate for Section 7A only was [REDACTED], which was [REDACTED] than SoCalGas and SDG&E's preliminary cost estimate for construction.

Section 7B

1. SoCalGas and SDG&E's Preliminary Construction Cost Estimate (*confidential*):
SoCalGas and SDG&E's preliminary cost estimate for Section 7B construction was [REDACTED].
2. Construction Contractor's Target Price Estimate (*confidential*): The Construction Contractor's cost estimate for Section 7B only was [REDACTED], which was [REDACTED] than SoCalGas and SDG&E's preliminary cost estimate for construction.

Pipeline Safety Enhancement Plan Final Report
Supply Line 36-9-09 Section 7A and 7B Replacement Project

B. Construction Schedule

Table 3: Construction Timeline

Section 7A	
Construction Start Date	09/06/2016
Construction Completion Date	12/23/2016
NOP Date	12/06/2016
Section 7B	
Construction Start Date	05/18/2015
Construction Completion Date	12/18/2015
NOP Date	11/23/2015

C. Changes During Construction

SoCalGas and SDG&E successfully mitigated conditions for Section 7A during construction in a manner that minimized potential impacts on project scope, cost, and schedule. As a result, these conditions did not result in any notable change orders.

The conditions summarized below were encountered for Section 7B during construction. Activities to address or mitigate these conditions resulted in approximately \$5,400,000 in change orders.

1. Site Conditions:

- a. Additional shoring equipment was required at several locations along the excavation route due to soil conditions being different than the planned Type C soil. These unforeseen soil types slowed the installation rate from the planned average of 247 feet per day of installed pipe to an average of 210 to 217 feet per day.
- b. The Construction Contractor encountered approximately 9,000 feet of 10-inch thick asphalt as opposed to the anticipated 6-inch thick asphalt. This required additional saw cutting and excavation.

Pipeline Safety Enhancement Plan Final Report
Supply Line 36-9-09 Section 7A and 7B Replacement Project

- c. Uncontaminated groundwater was present in some areas of the alignment that required dewatering of the trench and bell holes before pipe could be placed in the trench, slowing the installation.
2. Substructures: Despite SoCalGas and SDG&E's due diligence during preconstruction by potholing to identify substructures, additional abandoned and unmapped utilities were encountered during construction requiring abatement and removal.
 - a. An abandoned [REDACTED] pipeline was encountered within the planned alignment for the new [REDACTED] gas line requiring multiple alignment changes because SoCalGas and SDG&E Gas Standards require maintenance of six feet of separation. Mitigation efforts were also required once the presence of asbestos in pipe coating was identified on the abandoned line.
 - b. Potholing was required to confirm the location of the utilities in the proposed alignment along Stanton Road.
3. Work Hours: Due to safety concerns with high speed traffic, night shifts and road closures were increased to improve the safety of construction crews and the public.
4. Schedule Delay: Unplanned delays extended the Project by approximately six weeks. Additional field support costs were incurred to support the completion of this project.
5. Site Restoration: The County's encroachment permit, received after the Statement of Work and Construction Contractor Target Price Estimate was accepted, required the roadway to be resurfaced to a full lane width rather than the planned 12-foot width.

Pipeline Safety Enhancement Plan Final Report
Supply Line 36-9-09 Section 7A and 7B Replacement Project

6. Environmental Abatement: Contaminated soil was identified in one of the installation bell holes, which required abatement. This resulted in a 100-foot section of trench being temporarily skipped until mitigation methods were identified.

Pipeline Safety Enhancement Plan Final Report
Supply Line 36-9-09 Section 7A and 7B Replacement Project

Figure 10: Section 7A - Stripping and Excavating a Trench Near the Valve Assembly



Pipeline Safety Enhancement Plan Final Report
Supply Line 36-9-09 Section 7A and 7B Replacement Project

Figure 11: Section 7A - Side Booms to Move Welded Pipe into the Trench



Pipeline Safety Enhancement Plan Final Report
Supply Line 36-9-09 Section 7A and 7B Replacement Project

Figure 12: Section 7A – Removal of Pipe from a Bending Machine After Fabrication of a Sag Bend



Pipeline Safety Enhancement Plan Final Report
Supply Line 36-9-09 Section 7A and 7B Replacement Project

Figure 13: Section 7A - HDD Pipe Lifted for Transport to HDD Entry Point



Pipeline Safety Enhancement Plan Final Report
Supply Line 36-9-09 Section 7A and 7B Replacement Project

Figure 14: Section 7A - Lowering Pipe into a Trench



Pipeline Safety Enhancement Plan Final Report
Supply Line 36-9-09 Section 7A and 7B Replacement Project

Figure 15: Section 7B - Shoring and Placement Equipment Used to Maintain Integrity of the Excavated Trench



Pipeline Safety Enhancement Plan Final Report
Supply Line 36-9-09 Section 7A and 7B Replacement Project

D. Commissioning and Site Restoration

Commissioning activities include restoration of the site, final inspection and placement of the pipeline back into service, transportation and disposal of hydrotested water and hazardous material, and site demobilization.

Closeout activities include development of final as-built drawings, finalization of a reconciliation package, and updates to company recordkeeping systems to reflect the completed scope of work.

Pipeline Safety Enhancement Plan Final Report
Supply Line 36-9-09 Section 7A and 7B Replacement Project

IV. PROJECT COSTS

A. Cost Avoidance Actions

SoCalGas and SDG&E exercised due diligence in the planning, design, and construction activities for this project to minimize or avoid costs when prudent to do so. As discussed above, the Project team conducted a site visit to identify and incorporate discernible site conditions into the engineering, design, and planning of the Project. Specific examples of cost avoidance actions taken on this project are:

1. Engineering and Design: The Project team converted a section of existing pipeline to medium pressure and avoided tie-over labor costs of service taps and future maintenance costs.
2. Materials: Bulk ordering enabled SoCalGas and SDG&E to obtain favorable volume pricing for the [REDACTED] pipe.
3. Planning and Coordination: The Project team obtained additional workspace nearby to facilitate fabrication of the pipe string for the HDD without having to construct a shallow trench.
4. Construction Execution: The Project team successfully eliminated the requirement to repave the laydown yard after construction.

Pipeline Safety Enhancement Plan Final Report
Supply Line 36-9-09 Section 7A and 7B Replacement Project

B. Cost Estimate

Based on the preliminary design, once the project scope was confirmed and engineering, design, and planning activities were underway, SoCalGas and SDG&E prepared estimates of the Direct Costs of the Project in the amount of \$31,240,737. The estimate for Section 7A was prepared in January of 2016, using the “SCG Pipeline Estimate Template Rev 3” estimating tool and the estimate for Section 7B was prepared in May of 2015, using the “SCG Pipeline Estimate Template Rev 2” estimating tool the most current versions of the PSEP Estimate Template at the time. The Project Team considered the conditions known at the time to prepare the preliminary Direct Cost estimate. This estimate reflects the projected Labor, Material, and Services costs anticipated to be incurred to execute the Project.

SoCalGas and SDG&E estimated Indirect Costs of the Project based on the estimated Direct Costs and other project related variables.

C. Actual Direct and Indirect Costs

Actual Direct Costs reflect the Labor, Material, and Service costs incurred to execute the Project. Actual Indirect Costs reflect costs for incremental overhead loaders in accordance with Company overhead allocation policies. The total loaded cost of the Project is \$37,744,598.

Pipeline Safety Enhancement Plan Final Report
Supply Line 36-9-09 Section 7A and 7B Replacement Project

Table 4: Estimated and Actual Direct Costs and Variances

Direct Costs (\$)	Estimate	Actuals	Delta Over/(Under)
Company Labor	905,498	389,466	(516,032)
Materials	1,362,530	1,169,249	(193,281)
Construction Contractor	16,842,968	21,179,597	4,336,629
Construction Management & Support	2,799,351	3,183,218	383,867
Environmental	1,142,316	993,777	(148,539)
Engineering & Design	3,183,196	2,571,930	(611,266)
Project Management & Services	978,123	1,025,335	47,232
ROW & Permits	750,675	438,020	(312,655)
GMA	3,276,080	3,992,005	715,925
Total Direct Costs	31,240,737	34,942,618	3,701,881

Table 5: Estimated and Actual Indirect Costs, Total Costs, and Variances

Indirect Costs/Total Costs (\$)	Estimate	Actuals	Delta Over/(Under)
Overheads	2,424,222	2,316,162	(108,060)
AFUDC	1,963,204	412,625	(1,550,579)
Property Taxes	429,285	73,193	(356,092)
Total Indirect Costs	4,816,711	2,801,980	(2,014,731)
Total Direct Costs	31,240,737	34,942,618	3,701,881
Total Loaded Costs	36,057,448	37,744,598	1,687,150

D. Disallowance

There is no disallowance calculation for the Supply Line 36-9-09 North Section 7A and 7B Project, as there were no post-1955 segments included in the Project without records that provide the minimum information to demonstrate compliance with then applicable industry standards or regulatory strength testing and recordkeeping requirements.

Pipeline Safety Enhancement Plan Final Report
Supply Line 36-9-09 Section 7A and 7B Replacement Project

V. CONCLUSION

SoCalGas and SDG&E enhanced the safety of their integrated natural gas transmission system by prudently executing the Supply Line 36-9-09 North Section 7A and 7B Replacement Project. Through this Replacement Project, SoCalGas and SDG&E successfully replaced and rerouted 4.26 miles of pipeline in the City of Arroyo Grande. The total loaded cost of the Project is \$37,744,598.

SoCalGas and SDG&E executed this complex project that required restricted hours, night work and road closures; rerouting the pipeline to avoid environmental and culturally sensitive areas; responding prudently to unknown conditions regarding substructures, sandy soil conditions that required additional shoring, shortened pipe length segments and requiring more bell holes; and prudently addressing delays and unanticipated field changes (abatement of pipe coating and contaminated ground water).

SoCalGas and SDG&E engaged in prudent cost avoidance efforts by engaging in reasonable efforts to promote competitive and market-based rates for contractor services and materials, and used a reasonable amount of company and contractor resources given the complexity of this project.

End of Supply Line 36-9-09 North Section 7A and 7B Replacement Project Final Report

Pipeline Safety Enhancement Plan Final Report
Supply Line 37-07 Replacement Project**I. SUPPLY LINE 37-07 REPLACEMENT PROJECT**

A. Background and Summary

Supply Line 37-07 is a [REDACTED] diameter transmission line in a highly-developed, densely populated urban area that runs approximately three miles from Crenshaw Station in the City of Inglewood and ends at the intersection of 8th Avenue and 59th Street in the City of Los Angeles. The pipeline is primarily routed across a Class 3 location. This report describes the activities associated with the Supply Line 37-07 Replacement Project, which consists of the replacement of 3.222 miles of pipeline and installation of two new mainline valves (MLVs). The specific attributes of this Project are detailed in Table 1 below. The total loaded cost of the Project is \$31,287,717.

This is one of five PSEP projects that comprise the Gardena Bundle. SoCalGas and SDG&E bundled these projects to coordinate schedules and reduce costs for customers by sharing a laydown yard, optimizing the use of construction crews to minimize downtime, and effectively managing the engineering and planning contractor and company resources. The other PSEP projects in the Gardena Bundle are Supply Line 30-18, Supply Line 37-07 Section 5, Supply Line 37-18, Supply Line 37-18-F, and Supply Line 37-18-K.

Pipeline Safety Enhancement Plan Final Report Supply Line 37-07 Replacement Project

Table 1: General Project Information

Project Name		Supply Line 37-07		
Project Type	Replacement			
Length	3.222 miles			
Location	City of Inglewood and City of Los Angeles			
Class	3			
MAOP (<i>confidential</i>)	██████████			
Pipe Vintage	1945			
Construction Start	09/22/2014			
Construction Finish	02/12/2016			
Original Pipe Diameter (<i>confidential</i>)	██████████			
New Diameter (<i>confidential</i>)	██████████			
Original SMYS ¹ (<i>confidential</i>)	██████			
New SMYS (<i>confidential</i>)	██████			
Project Costs (\$)	Capital	O&M	Total	
Loaded Project Costs	31,283,040	4,677	31,287,717	
Disallowed Costs	-	-	-	

¹ Highest percentage of Specified Minimum Yield Strength (SMYS) of Category 4 Criteria pipe.

Pipeline Safety Enhancement Plan Final Report
Supply Line 37-07 Replacement Project

B. Maps and Images

Figure 1: Overview Map of Gardena Bundle

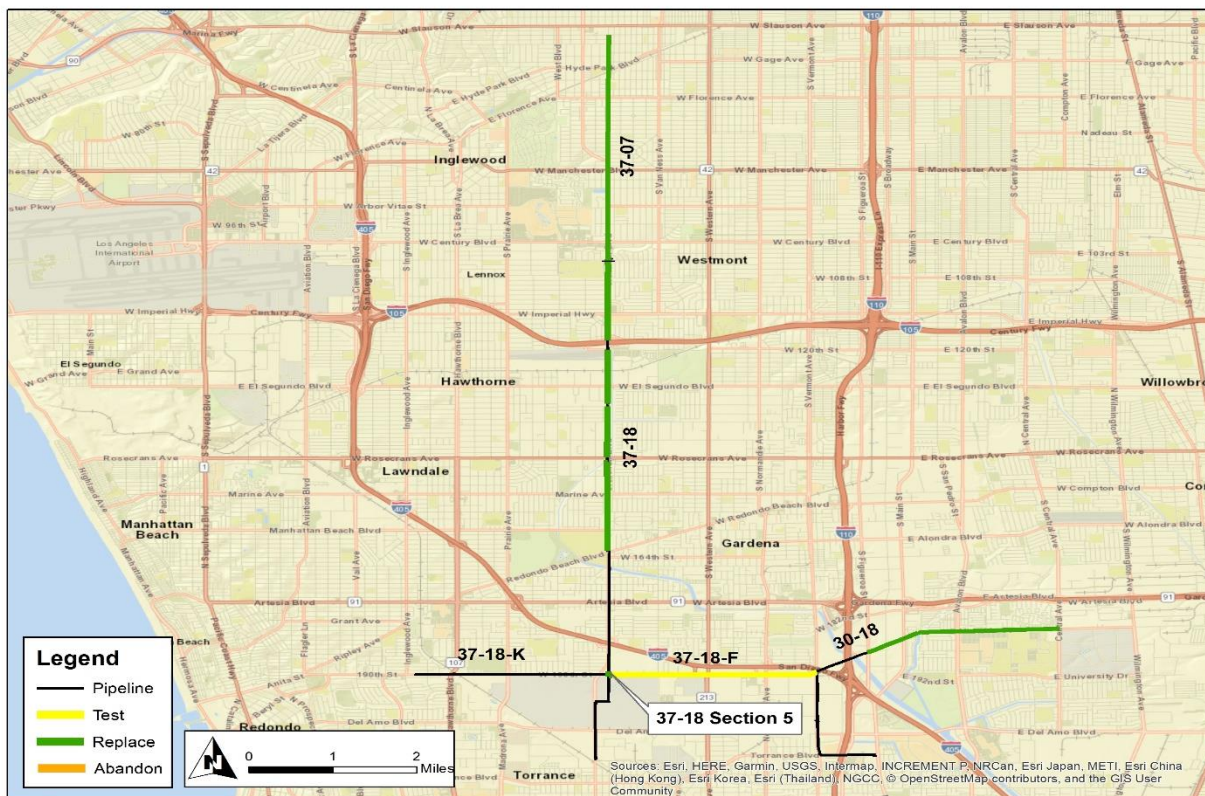

Pipeline Safety Enhancement Plan Final Report Supply Line 37-07 Replacement Project

Figure 2: Satellite Image of Supply Line 37-07 Replacement Project

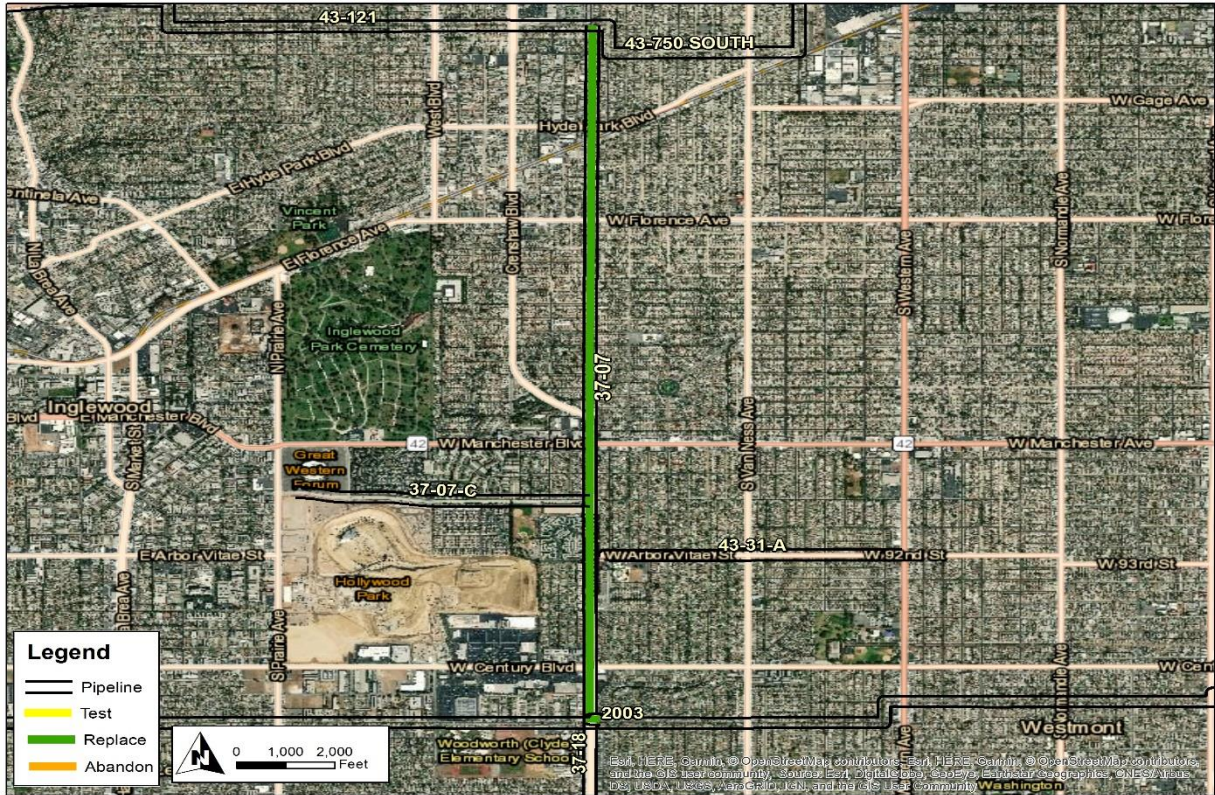

Pipeline Safety Enhancement Plan Final Report Supply Line 37-07 Replacement Project

Figure 3: Overview Map of Supply Line 37-07 Replacement Project

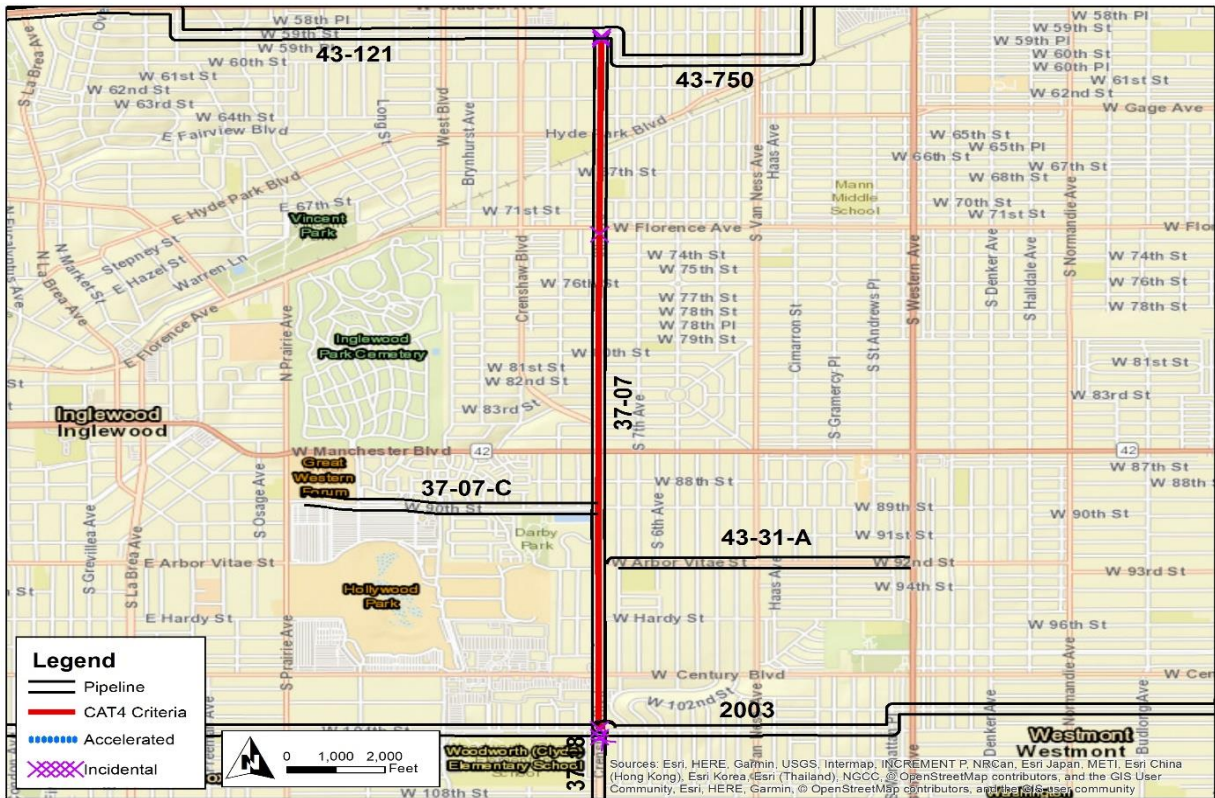

Pipeline Safety Enhancement Plan Final Report
Supply Line 37-07 Replacement Project

II. ENGINEERING, DESIGN, AND PLANNING

A. Project Scope

Table 2: Mileage Information

	Criteria	Accelerated	Incidental	New	Total ²
Final Mileage	3.095 mi.	0 mi.	0.045 mi.	0.082 mi.	3.222 mi.
	16,344 ft.	0 ft.	236 ft.	430 ft.	17,010 ft.

SoCalGas and SDG&E presented a conceptual project scope in workpapers supporting the 2011 PSEP filing.³ Prior to initiating execution of the Project in 2014, SoCalGas and SDG&E reviewed existing pipeline records to validate the scope of the Project. During the Engineering, Design, and Planning phase, SoCalGas and SDG&E further refined the scope. This progression of the project scope is summarized as follows:

1. 2011 PSEP Filing: SoCalGas and SDG&E identified Supply Line 37-07 as a Phase 1A Replacement Project comprised of 2.673 Category 4 Criteria miles and 31 feet of Accelerated pipe.
2. Scope Validation: Through scope validation activities, after the 2011 filing, SoCalGas and SDG&E increased the scope of this project to include an additional 0.423 miles of Category 4 Criteria pipe.
3. Engineering, Design, and Constructability:
 - a. Based on further review of the replacement pipeline scope, the Project Team included 95 feet of Incidental pipe between three small segments within the Criteria replacement section. The Project Team added these Incidental pipe

² Values may not add to total due to rounding.

³ See Amended PSEP of SoCalGas and SDG&E, submitted December 2, 2011, in R.11-02-019 and subsequently transferred to A.11-11-002.

Pipeline Safety Enhancement Plan Final Report
Supply Line 37-07 Replacement Project

segments as part of the replacement to avoid the need to implement costly and complex tie-in methods for each of the small segments.

- b. During construction, the Project Team determined that the north tie-in would need to be modified from the original design due to existing utilities conflicting with the tie in location. To address the utility conflicts, the Project Team extended the tie-in length, resulting in a total of 236 feet of Incidental pipe and the offset alignment required installation of 430 feet of new pipe.
4. Final Project Scope: The final project scope consists of a 3.222-mile pipeline replacement and installation of two new MLVs. There was no Accelerated mileage and 236 feet of Incidental pipe.

B. Decision Tree Analysis

SoCalGas and SDG&E performed a PSEP Decision Tree analysis of Supply Line 37-07 and confirmed the project design should commence as a Replacement Project.

Pipeline segments installed prior to 1946 that are not capable of being assessed using in-line inspection technology are identified for replacement under the approved PSEP Decision Tree. As explained in the testimony supporting the approved PSEP, as part of the work previously completed during implementation of federal gas transmission pipeline integrity management regulations (49 CFR 192, Subpart O), SoCalGas and SDG&E previously identified, retrofitted and in-line inspected pre-1946 transmission pipelines that were constructed using acceptable welding techniques and are operationally suited to in-line inspection. The remaining pre-1946 segments in the SoCalGas/SDG&E system are not suited for in-line inspection, likely have non-state-of-the-art welds, and would require significant investment for retrofitting to accommodate in-line inspection tools. Accordingly, consistent with the Commission's directive in D.11-06-017 to "address retrofitting pipeline to allow for inline inspection tools," the requirement in California Public Utilities Code section 958 that upon completion of the

Pipeline Safety Enhancement Plan Final Report Supply Line 37-07 Replacement Project

PSEP, where warranted, pipelines are to be capable of accommodating in-line inspection devices, and the overarching objectives of PSEP to enhance the safety of the pipeline system in a proactive, cost effective manner, the approved PSEP Decision Tree identifies pre-1946 non-piggable pipeline segments for abandonment and/or replacement.

Through this Decision Tree analysis, SoCalGas and SDG&E identified replacement as the more prudent option. Key considerations that support SoCalGas and SDG&E's determination to replace this segment include:

1. Piggability: Non-piggable.
2. Pipe Vintage: 1945.
3. Longseam Type: Unknown.
4. Longseam Repair History: No identified issues.
5. Condition of Coating: No identified issues.
6. History of Leaks: No identified issues.

C. Engineering, Design, and Planning Factors

SoCalGas and SDG&E reviewed pipeline drawings and other information, contacted internal planning groups, communicated with external stakeholders, conducted survey activities, including reviewing public records and potholing of the area to confirm the presence of underground utilities and substructures, and completed a pre-design site walk. Key factors that influenced the engineering and design of the Project are as follows:

Pipeline Safety Enhancement Plan Final Report
Supply Line 37-07 Replacement Project

1. Schedule Coordination:

- a. Due to system capacity issues in the City of Los Angeles along Sepulveda Boulevard, the Project Team was required to complete the planned work on Supply Line 37-07 prior to the isolation of the Supply Line 43-121 North Project. The project teams for the two PSEP projects coordinated project schedules.
- b. The other five active Gardena Bundle projects (Supply Line 30-18, Supply Line 37-07 Section 5, Supply Line 37-18, Supply Line 37-18-K and Supply Line 37-18-F) were coordinated to optimize use of construction crews and minimize downtime and standby charges. The Project team deployed crews to work on other Gardena Bundle projects between mobilizations. For the Supply Line 37-07 Replacement Project, this resulted in two planned mobilizations. The first mobilization consisted of installation of the replacement pipe. The second mobilization consisted of hydrotesting the replacement pipe, completing tie-in activities, and abandoning the original pre-1946 pipe.

2. Shut-In Analysis: The Project team completed a Request for Engineering Review (RER) analysis and concluded the regulator stations fed by Supply Line 37-07 could not be shut-in for extended periods of time during winter conditions. Therefore, shut-in was scheduled to occur during summer conditions. If the schedule required the line to be shut-in during winter conditions, completion of the Project could have posed a risk of disruption of service to customers.

3. Customer Impacts:

- a. Five core customers served by this line could be served by a medium pressure line parallel to the Project. The customers could be permanently transferred during a period of low demand, so the Project team did not anticipate any unmanageable impacts for these customers. Temporary service to these customers was not required, minimizing overall construction costs. Transfer of

Pipeline Safety Enhancement Plan Final Report
Supply Line 37-07 Replacement Project

- the customer taps would be completed by the district prior to the replacement project going to construction.
- b. Supply Line 37-07 also has four laterals feeding regulator stations that the Project team could isolate for the duration of the tie-ins in summer conditions.
4. Permit Restrictions: The City of Los Angeles and the City of Inglewood required permits.
 - a. City of Los Angeles: A city moratorium required stopping construction on Crenshaw Boulevard from November 18 through January 5. Work hours in the City of Los Angeles were Monday through Saturday from 9:00 am to 3:30 pm.
 - b. City of Inglewood: The city restricted work hours to Monday through Friday from 7:00 am to 3:30 pm and Saturday 9:00 am to 6:00 pm.
 5. Land Use: Due to the Project's location in a high-traffic residential neighborhood, there was a lack of usable space for a laydown yard. Therefore, the Broadway laydown yard and a retail hardware store work site that had been acquired for the Gardena Bundle lines were shared with this project.
 6. Internal Coordination: Region Operations had evaluated various options to increase the capacity from the South Bay area of Los Angeles up to the West Los Angeles area along Sepulveda Boulevard. SoCalGas and SDG&E determined that the most cost-effective method of increasing the capacity to this area, and addressing PSEP objectives, would be to upsize the PSEP replacement pipe on Supply Line 37-07 from [REDACTED] to [REDACTED]. The additional cost to upsize the supply line was funded by the Operating District, as discussed below in Actual Direct and Indirect Costs.
 7. Substructures: SoCalGas and SDG&E identified several substructures during potholing that required the new pipe be rerouted under the substructures.

Pipeline Safety Enhancement Plan Final Report Supply Line 37-07 Replacement Project

8. Valves:

- a. The Project team identified one MLV for replacement, because it was the same vintage as the pipe (pre-1946), and needed to be upsized, to coincide with the upsized diameter of the pipe.
- b. The Project team identified four valves that feed laterals to core customers off Supply Line 37-07 for replacement.

D. Scope Changes

SoCalGas and SDG&E did not make any notable scope changes during detailed design.

Pipeline Safety Enhancement Plan Final Report
Supply Line 37-07 Replacement Project

III. CONSTRUCTION

A. Construction Contractor Selection

The Project team prepared an initial cost estimate based on the preliminary design. Following completion of the engineering, design, and planning activities described above, the Project team directed the Performance Partner to prepare cost estimates based on a more detailed engineering design package. As indicated above, there were no notable changes in scope between the time when the Project team prepared the preliminary cost estimate and when the Performance Partner prepared and submitted its Target Price Estimate. SoCalGas and SDG&E awarded the construction contract to the Performance Partner.

1. SoCalGas and SDG&E’s Preliminary Construction Cost Estimate (confidential):

SoCalGas and SDG&E’s preliminary cost estimate for construction was [REDACTED].

2. Construction Contractor’s Target Price Estimate (confidential): The Construction

Contractor’s cost estimate was [REDACTED], which was [REDACTED] than SoCalGas and SDG&E’s preliminary cost estimate for construction.

B. Construction Schedule

Table 3: Construction Timeline

Construction Start Date	09/22/2014
Construction Completion Date	02/12/2016
NOP Date	11/05/2015

Pipeline Safety Enhancement Plan Final Report
Supply Line 37-07 Replacement Project

C. Changes During Construction

The conditions summarized below were encountered during construction. Activities to address or mitigate these conditions resulted in approximately \$718,000 in change orders.

1. Field Design Changes:

- a. The Project team redesigned and extended the north tie-in during construction. The Project team determined during excavation that the existing utilities and piping configuration were different than the historical records. The Project team planned to utilize an existing valve to achieve isolation, but because of a conflict with other substructures, determined it would be necessary to redesign the tie-in, resulting in a new valve and stopple fitting. This valve replacement enabled SoCalGas and SDG&E to make the entire pipeline piggable.
- b. The Project team initially designed the Project to traverse one railroad crossing and two intersections using a jack-and-bore method. With the approval of the railroad company, the Construction Contractor requested a change in the field to utilize an open cut excavation method for the intersection and a modified tunneling excavation method for the railroad, to decrease traffic control impacts and allow for ease of construction.

2. Material Delays: Due to an unanticipated dockworker strike at the Port of Long Beach (Port), the MLVs arrived at the Port but could not be unloaded or delivered for three weeks. The Construction Contractor adjusted its construction activities to avoid delays to the overall schedule.

3. Schedule Change:

- a. The Project team initially mobilized construction for pipe lay while completing design efforts for tie-ins with the expectation for both to be completed at the

Pipeline Safety Enhancement Plan Final Report Supply Line 37-07 Replacement Project

same time to continue construction efforts. As mentioned above, the tie-in design for the north end was redesigned to address actual conditions encountered during construction. The Project team demobilized construction until the tie-in design was completed. Remobilization occurred to complete preparation of taps to provide temporary service, hydrotesting of the replacement line, tie-in replacements, tap reconnection, and abandonment of the original pipeline.

- b. The Construction Contractor remobilized in August of 2015 and the tie-in was completed in November of 2015, during a period of forecasted lower than average customer demand. The Project team monitored conditions leading up to tie-in to confirm that customers would not be impacted.

D. Commissioning and Site Restoration

Commissioning activities include restoration of the site, final inspection and placement of the pipeline back into service, transportation and disposal of hydrotested water and hazardous material, and site demobilization.

Closeout activities include development of final as-built drawings, finalization of a reconciliation package, and updates to company recordkeeping systems to reflect the completed scope of work.

Pipeline Safety Enhancement Plan Final Report
Supply Line 37-07 Replacement Project

IV. PROJECT COSTS

A. Cost Avoidance Actions

SoCalGas and SDG&E exercised due diligence in the planning, design, and construction activities for this project to minimize or avoid costs when prudent to do so. As discussed above, the Project team conducted a site visit to identify and incorporate discernible site conditions into the engineering, design, and planning of the Project. Specific examples of cost avoidance actions taken on this project are:

1. Materials: SoCalGas and SDG&E purchased pipe and standard fittings in bulk for all the Gardena Bundle projects.
2. Planning and Coordination:
 - a. The Project Team scheduled work for the Gardena Bundle projects in phases, and construction crews moved between Gardena Bundle projects to avoid downtime and standby charges.
 - b. Tie-in of Supply Line 37-07 was scheduled to take place during summer conditions, when demand on the distribution system was low, allowing for shut-in and avoiding the need for temporary gas supply to maintain service to customers on the lateral connections. While the Project team eventually delayed tie-in activities to take place in the Fall, SoCalGas and SDG&E were able to mitigate customer impacts through system valve position alterations to maintain gas flow to the lateral connections.
3. Construction Execution: The three crossings that were addressed in the field through an open cut installation method, rather than the initially planned jack-and-bore method, resulted in cost savings.

Pipeline Safety Enhancement Plan Final Report
Supply Line 37-07 Replacement Project

4. Land Use: The Gardena Bundle projects utilized the same main laydown yard, eliminating mobilization and demobilization costs during downtimes.

B. Cost Estimate

Based on the preliminary design, once the project scope was confirmed and engineering, design, and planning activities were underway, SoCalGas and SDG&E prepared an estimate of the Direct Costs of the Project in the amount of \$23,971,692. This estimate was prepared in May of 2014, using the “SCG Pipeline Estimate Template Rev 0” estimating tool, the most current version of the PSEP Estimate Template at the time. The Project Team considered the conditions known at the time to prepare the preliminary Direct Cost estimate. This estimate reflects the projected Labor, Material, and Services costs anticipated to be incurred to execute the Project.

SoCalGas and SDG&E estimated Indirect Costs of the Project based on the estimated Direct Costs and other project-related variables.

C. Actual Direct and Indirect Costs

Actual Direct Costs reflect the Labor, Material, and Service costs incurred to execute the Project. Actual Indirect Costs reflect costs for incremental overhead loaders in accordance with Company overhead allocation policies. The total loaded cost of the Project is \$31,287,717.

The total loaded costs for this project reflect the credit provided by the Operating District to fund the cost difference associated with the change in pipeline diameter. The Project team completed a comparative cost estimate during the preliminary design of the two diameters to calculate the estimated incremental cost difference associated with the change in pipeline diameter.

Pipeline Safety Enhancement Plan Final Report Supply Line 37-07 Replacement Project

Table 4: Estimated and Actual Direct Costs and Variances

Direct Costs (\$)	Estimate	Actuals ⁴	Delta Over/(Under)
Company Labor	614,228	248,968	(365,260)
Materials	3,371,645	747,465	(2,624,180)
Construction Contractor	13,123,864	14,048,063	924,199
Construction Management & Support	1,033,725	2,318,169	1,284,444
Environmental	328,440	575,278	246,838
Engineering & Design	1,747,203	3,701,138	1,953,935
Project Management & Services	1,145,860	2,361,614	1,215,754
ROW & Permits	72,050	258,449	186,399
GMA	2,534,677	3,157,378	622,701
Total Direct Costs	23,971,692	27,416,522	3,444,830

Table 5: Estimated and Actual Indirect Costs, Total Costs, and Variances

Indirect Costs/Total Costs (\$)	Estimate	Actuals	Delta Over/(Under)
Overheads	2,387,859	1,959,897	(427,962)
AFUDC	2,675,933	1,700,658	(975,275)
Property Taxes	533,188	210,640	(322,548)
Total Indirect Costs	5,596,980	3,871,195	(1,725,785)
Total Direct Costs	23,971,692	27,416,522	3,444,830
Total Loaded Costs	29,568,672	31,287,717	1,719,045

⁴ Actual Material and Construction Contractor costs exclude the cost of upsizing the pipe.

Pipeline Safety Enhancement Plan Final Report
Supply Line 37-07 Replacement Project

D. Disallowance

There are no disallowance calculations for the Supply Line 37-07 Replacement Project as there were no post-1955 segments included in the Project without records that provide the minimum information to demonstrate compliance with then applicable industry standards or regulatory strength testing and recordkeeping requirements.

Pipeline Safety Enhancement Plan Final Report
Supply Line 37-07 Replacement Project

V. CONCLUSION

SoCalGas and SDG&E enhanced the safety of their integrated natural gas transmission system by prudently executing the Supply Line 37-07 Replacement Project. Through this Replacement Project, SoCalGas and SDG&E successfully replaced 3.222 miles of predominately pre-1946 vintage high pressure pipeline in the City of Los Angeles, increasing the system capacity and improving service to the surrounding area. In addition, SoCalGas and SDG&E replaced six pre-1946 valves with two new MLVs and four new lateral feed valves. The total loaded cost of the Project is \$31,287,717.

SoCalGas and SDG&E executed this project prudently through monitoring weather and demand conditions to minimize customer impacts; and removing and replacing non-piggable features. In addition, through coordination with the railroad, SoCalGas and SDG&E reduced excavation costs by implementing an open trench, rather than jack-and-bore construction method.

SoCalGas and SDG&E engaged in prudent cost avoidance efforts by procuring material through bulk purchase orders and coordinating construction activities with five other projects to optimize the efficiency of the construction crews and minimize downtime and standby charges. SoCalGas and SDG&E safely completed construction along a major thoroughfare and replaced the pipe using a combination of internal and contracted construction management personnel to complete the safety enhancement project as soon as practicable.

End of Supply Line 37-07 Replacement Project Final Report

Pipeline Safety Enhancement Plan Final Report
Supply Line 37-18 Replacement Project

I. SUPPLY LINE 37-18 REPLACEMENT PROJECT

A. Background and Summary

Supply Line 37-18 is a predominantly [REDACTED] diameter transmission line that runs approximately seven miles through a highly-developed, densely populated industrial, and urban area along Crenshaw Boulevard from north of Interstate 105 to south of Interstate 405 in Los Angeles. The pipeline is primarily routed across a Class 3 location, and traverses some Class 1 locations. This report describes the activities associated with the Supply Line 37-18 Replacement Project, which consists of the replacement of 4.291 miles of pipeline with three bored crossings and installation of eight mainline valves (MLVs) and fourteen lateral valves. The specific attributes of this Project are detailed in Table 1 below. The total loaded cost of the Project is \$58,053,699.

The Supply Line 37-18 Replacement Project is a component of the Gardena Bundle, which is comprised of five PSEP projects. SoCalGas and SDG&E bundled these projects to coordinate schedules and reduce costs for customers by sharing a laydown yard, optimizing the use of construction crews to minimize downtime, and effectively managing the engineering, planning contractor, and company resources. The other PSEP projects in the Gardena Bundle are Supply Line 30-18, Supply Line 37-18, Supply Line 37-18-F, and Supply Line 37-18-K.

Pipeline Safety Enhancement Plan Final Report Supply Line 37-18 Replacement Project

Table 1: General Project Information

Project Name	Supply Line 37-18		
Project Type	Replacement		
Length	4.291 miles		
Location	Inglewood, Hawthorne, Los Angeles, Gardena, and Torrance		
Class	3		
MAOP (<i>confidential</i>)	██████████		
Pipe Vintage	1945		
Construction Start	10/27/2014		
Construction Finish	10/20/2017		
Original Pipe Diameter (<i>confidential</i>)	██████████		
New Diameter (<i>confidential</i>)	██████████		
Original SMYS ¹ (<i>confidential</i>)	██████		
New SMYS (<i>confidential</i>)	██████		
Project Costs (\$)	Capital	O&M	Total
Loaded Project Costs	58,053,699	-	58,053,699
Disallowed Costs	-	-	-

¹ Highest percentage of Specified Minimum Yield Strength (SMYS) of Category 4 Criteria pipe.

Pipeline Safety Enhancement Plan Final Report
 Supply Line 37-18 Replacement Project

B. Maps and Images

Figure 1: Overview Map of Gardena Bundle



Pipeline Safety Enhancement Plan Final Report Supply Line 37-18 Replacement Project

Figure 2: Satellite Image of Supply Line 37-18 Replacement Project

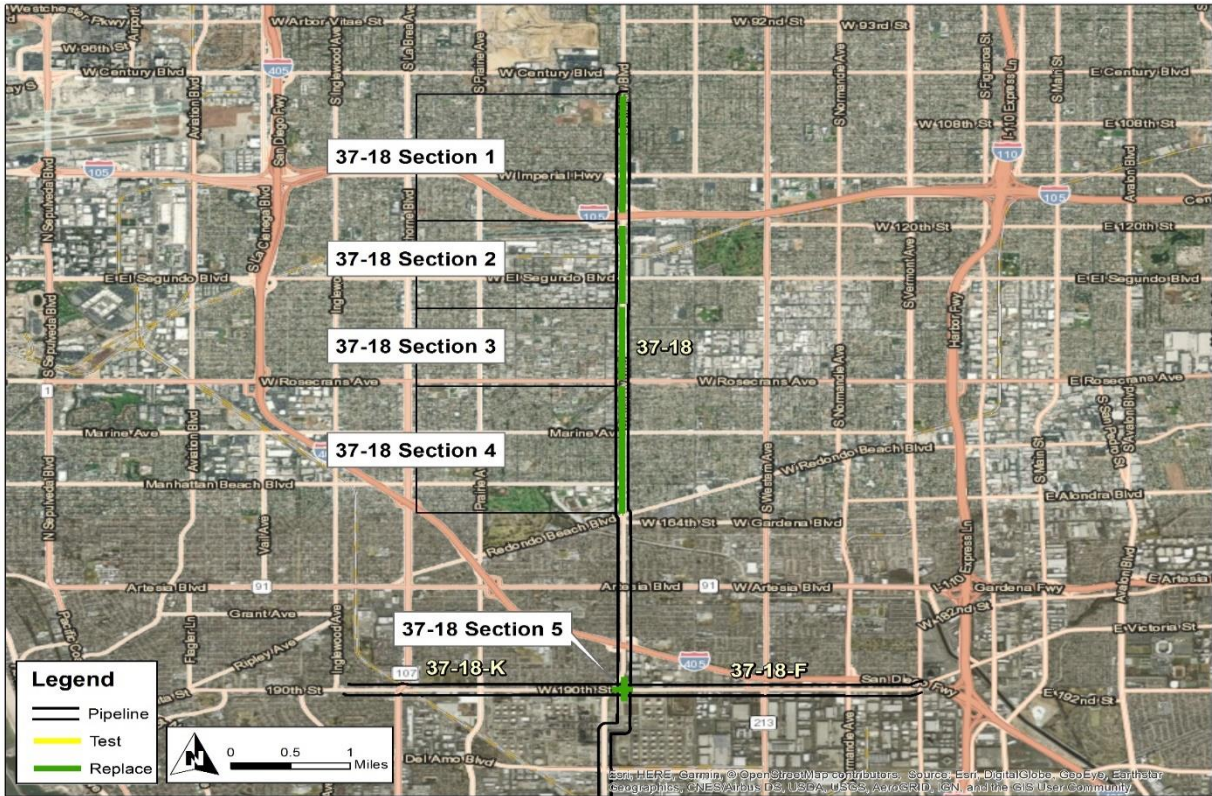

Pipeline Safety Enhancement Plan Final Report Supply Line 37-18 Replacement Project

Figure 3: Overview Map of Supply Line 37-18 Replacement Project

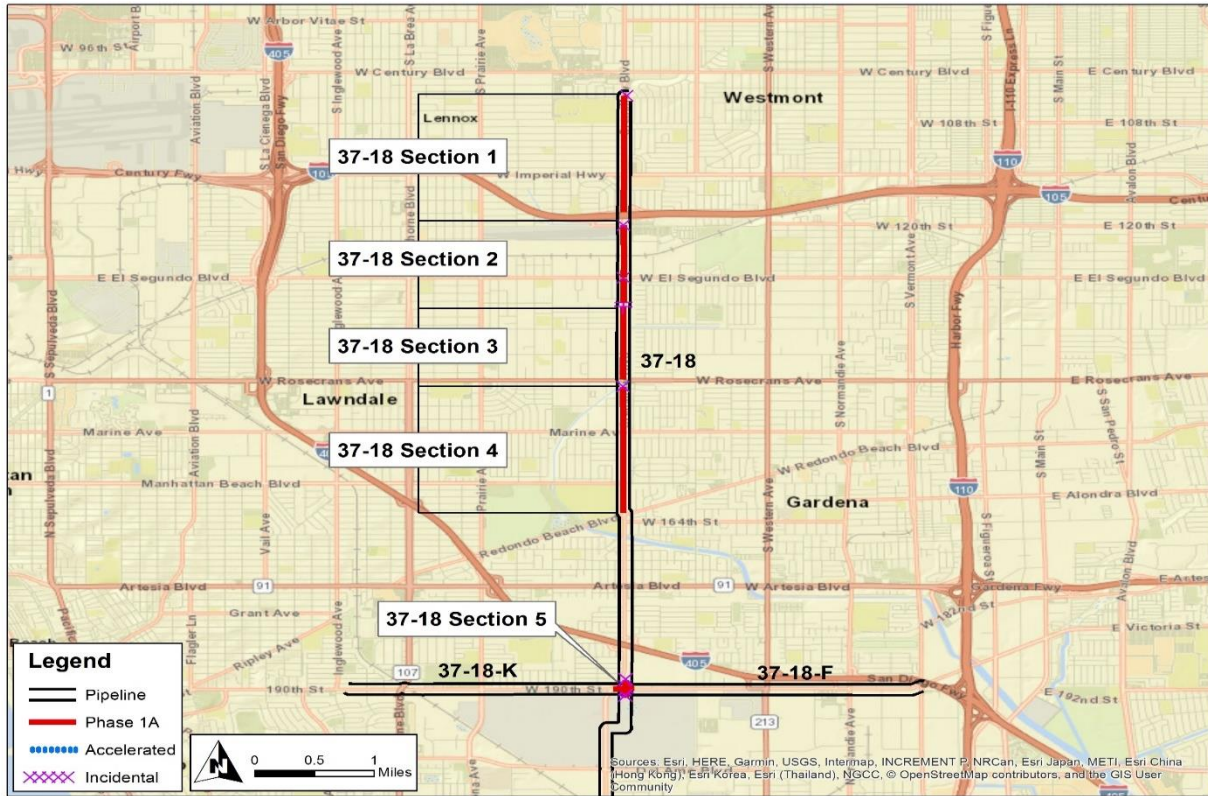

Pipeline Safety Enhancement Plan Final Report Supply Line 37-18 Replacement Project

Figure 4: Supply Line 37-18 Section 5 Replacement Project Schematic

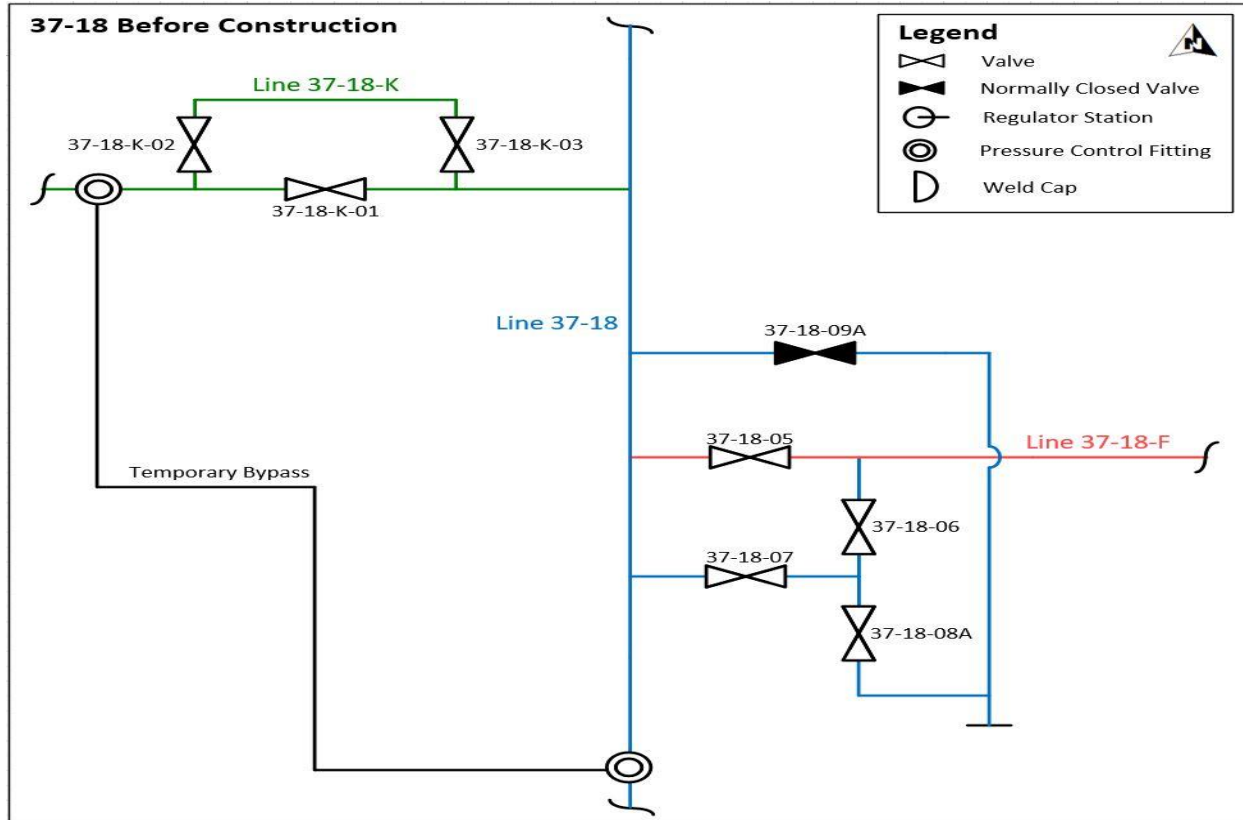

Pipeline Safety Enhancement Plan Final Report
Supply Line 37-18 Replacement Project

Figure 5: Supply Line 37-18 Section 5 Replacement Project Schematic

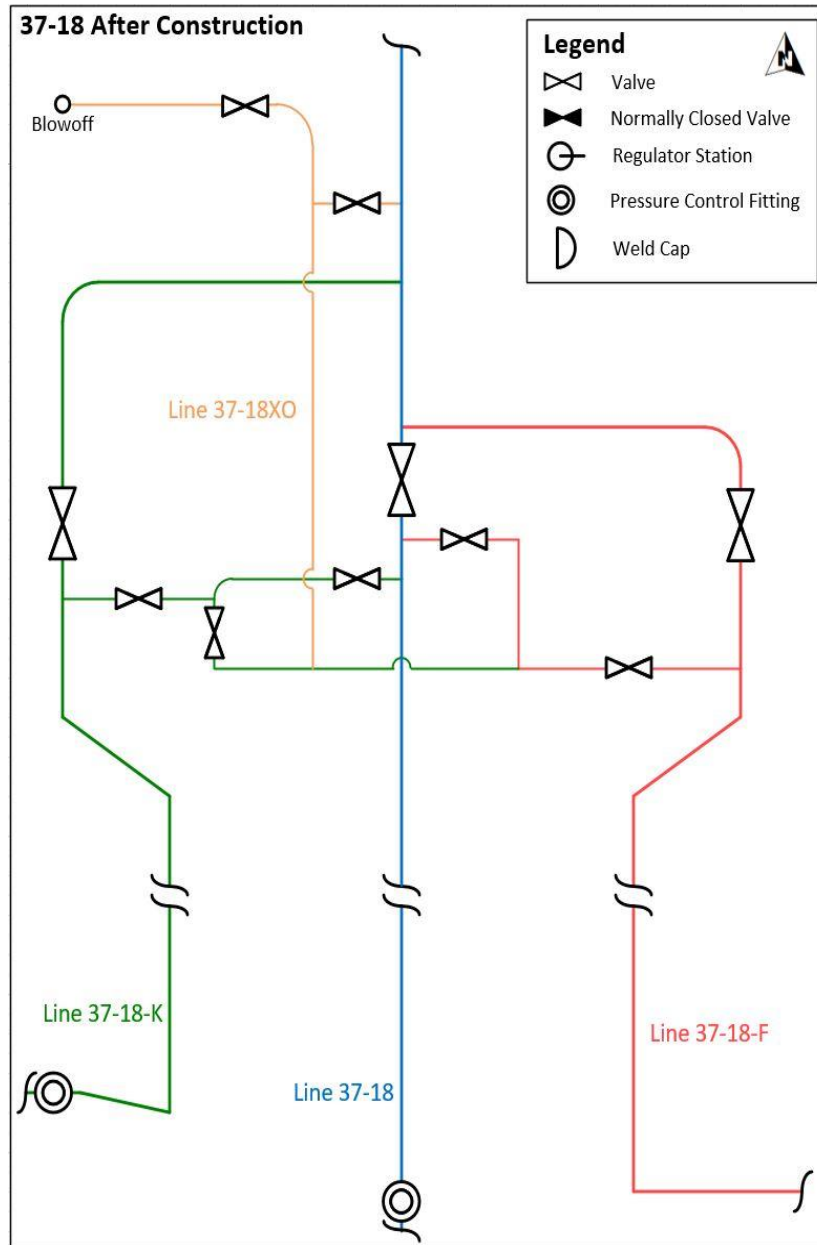

Pipeline Safety Enhancement Plan Final Report
Supply Line 37-18 Replacement Project

II. ENGINEERING, DESIGN, AND PLANNING

A. Project Scope

Table 2: Mileage Information

	Criteria	Accelerated	Incidental	New	Total ²
Final Mileage	3.774 mi.	0 mi.	0.141 mi.	0.376 mi.	4.291 mi.
	19,925 ft.	0 ft.	746 ft.	1,988 ft.	22,658 ft.

SoCalGas and SDG&E presented a conceptual project scope in workpapers supporting the 2011 PSEP filing.³ Prior to initiating execution of the Project in 2014, SoCalGas and SDG&E reviewed existing pipeline records to validate the scope of the Project. During the Engineering, Design, and Planning phase, SoCalGas and SDG&E further refined the scope. The progression of project scope is summarized as follows:

1. 2011 PSEP Filing: SoCalGas and SDG&E identified Supply Line 37-18 as a Phase 1A Replacement Project comprised of 3.561 miles of Category 4 Criteria pipe and 0.603 miles of Accelerated pipe.
2. Scope Validation: Through scope validation activities, after the 2011 filing and before initiating execution of the Project, SoCalGas and SDG&E increased the scope of the Project by 0.212 miles of Category 4 Criteria pipe.

² Values may not add to total due to rounding.

³ See Amended PSEP of SoCalGas and SDG&E, submitted December 2, 2011, in R.11-02-019 and subsequently transferred to A.11-11-002.

Pipeline Safety Enhancement Plan Final Report
Supply Line 37-18 Replacement Project

3. Engineering, Design, and Constructability:
 - a. The Project Team referred to the noncontiguous segments of the Category 4 Criteria pipe as Sections 1 through 5. The Category 4 Criteria pipe for Section 5 is located within the connection to two lateral pipelines, Supply Line 37-18-K and Supply Line 37-18-F. The Project Team included replacement of additional Category 4 Criteria mileage on these pipelines due to the need to replace the existing connections.
 - b. Incidental mileage was included because the tie-in locations were required to extend beyond the Category 4 Criteria segments.
4. Final Project Scope: The final project scope consists of a 4.291-mile replacement. The replacement pipe is 0.376 miles longer than the original alignment due to navigating around existing underground utilities, offset of the replacement alignment, and redesign of lateral connections.

B. Decision Tree Analysis

SoCalGas and SDG&E performed a PSEP Decision Tree analysis of Supply Line 37-18 and confirmed the project design should commence as a replacement project.

Pipeline segments installed prior to 1946 that are not capable of being assessed using in-line inspection technology are identified for replacement under the approved PSEP Decision Tree. As explained in the testimony supporting the approved PSEP, as part of the work previously completed during implementation of federal gas transmission pipeline integrity management regulations (49 CFR 192, Subpart O), SoCalGas and SDG&E previously identified, retrofitted and in-line inspected pre-1946 transmission pipelines that were constructed using acceptable welding techniques and which are operationally suited to in-line inspection.

Pipeline Safety Enhancement Plan Final Report
Supply Line 37-18 Replacement Project

The remaining pre-1946 segments in the SoCalGas/SDG&E system are not suited for in-line inspection, likely have non-state-of-the-art welds, and would require significant investment for retrofitting to accommodate in-line inspection tools. Accordingly, consistent with the Commission’s directive in D.11-06-017 to “address retrofitting pipeline to allow for inline inspection tools,” and the requirement in California Public Utilities Code Section 958 that upon completion of the PSEP, where warranted, pipelines are to be capable of accommodating in-line inspection devices, and the overarching objectives of PSEP to enhance the safety of the pipeline system in a proactive, cost effective manner, the approved PSEP Decision Tree identifies pre-1946 non-piggable pipeline segments for abandonment and/or replacement.

Through this Decision Tree analysis, SoCalGas and SDG&E identified replacement as the more prudent option. Key considerations that support SoCalGas and SDG&E’s determination to replace this segment include:

1. Shut-In Analysis: The Project Team completed a Request for Engineering Review (RER) analysis and concluded Sections 1 through 4 of the pipeline could be taken out of service in sections. Section 5 could not be taken out of service, unless a temporary bypass was installed.
2. Customer Impacts: During a shut-in of Sections 1 through 4, customers would require compressed natural gas (CNG) or temporary service from an adjacent medium pressure system. During a shut-in of Section 5, the temporary bypass would maintain service to any impacted customers.
3. Community Impacts: Traffic impacts and occasional noise were anticipated. Section 5 included replacement of valves and a bridle configuration located in the middle of the street. The replacement would need to be relocated for ease and safety of future maintenance.

Pipeline Safety Enhancement Plan Final Report
Supply Line 37-18 Replacement Project

4. Permit Conditions: Multiple issues were identified relating to traffic control, work times, moratoriums, and coordinating between multiple permitting agencies.
5. Piggability: Non-piggable.
6. Pipe Vintage: 1945.
7. Existing Pipe Attributes: Features along the pipeline affecting piggability include miter bends, a plug valve, and multiple diameter changes.
8. Longseam Type: Unknown.
9. Longseam Repair History: No identified issues.
10. Condition of Coating: No identified issues.
11. History of Leaks: No identified issues.

C. Engineering, Design, and Planning Factors

SoCalGas and SDG&E reviewed pipeline drawings and other information, contacted internal planning groups, communicated with external stakeholders, conducted survey activities, including reviewing public records and potholing of the area to confirm the presence of underground utilities and substructures, and completed a pre-design site walk. Key factors that influenced the engineering and design of the Project are as follows:

Section 1, 2, 3, and 4

1. Shut-In Analysis: The Project Team planned to shut-in each section of the replacement project, one section at a time, to limit the amount of CNG required for customers and because there were Category 1 segments (generally at channel crossings) between the sections.

Pipeline Safety Enhancement Plan Final Report
Supply Line 37-18 Replacement Project

2. Customer Impacts: The Project Team planned to install new valves to provide alternate feed to the affected pressure districts and use a pressure control fitting (PCF) with bypass capability to maintain feed to the laterals during tie-in.
3. Diameter Changes: The Project Team replaced the existing [REDACTED] and [REDACTED] line with a [REDACTED] line based on the recommendation of the RER. The Operating District funded the cost to upsize the line and this cost is not included in the total cost of the PSEP project presented in this Application.
4. Schedule Coordination: Construction personnel were shifted to the other active Gardena Bundle projects as necessary to optimize use of the construction crews and minimize downtime and standby charges. The Project Team deployed crews to work on other Gardena Bundle projects between mobilizations.
5. Tie-In: The Project Team referred to the contiguous segments of Category 4 Criteria pipe as Sections. As stated all four sections were executed together. The Project Team did not plan to replace the small segments of Incidental pipe between the Sections as this would have required additional permitting and trenchless construction for crossings of Caltrans and channels. The Project Team planned and designed the four sections concurrently and planned for a single construction mobilization.
6. Land Use: Due to the Project's location in a high-traffic residential neighborhood, there was a lack of usable space for a laydown yard. Therefore, the Broadway laydown yard and a major retailer's parking lot that had been acquired as a work site for the Gardena Bundle lines were shared with this project.
7. Permit Conditions: Caltrans requires removal of abandoned pipe within its right-of-way (ROW). This required removal of approximately 170 feet of existing pipe.

Pipeline Safety Enhancement Plan Final Report
Supply Line 37-18 Replacement Project

8. Environmental: The Project Team anticipated groundwater risk and created a groundwater management plan. The construction permit required additional environmental permits if groundwater was encountered during construction.
9. Valves: The Replacement design included five new MLVs and eight lateral valves to replace the existing valves and to facilitate a tie-in and gas handling plan that would be least impactful to customers.
10. Constructability: The Project Team designed slick bore crossings for two major intersections and one railroad crossing.

Section 5

1. Customer Impact: The Project Team designed a temporary bypass utilizing stopple fittings to maintain service to customers during construction and tie-in operations.
2. Community Impact: The new valve bridles required a large excavation area. The Project Team relocated the replacement approximately 200 feet north of the existing bridle connection to reduce the traffic impact. A section of a minor arterial street was planned for complete closure to support construction activities.
3. Diameter Changes: The Project Team replaced the existing [REDACTED] line with a [REDACTED] line based on the recommendation of the RER. The Operating District funded the cost to upsize the line and this cost is not included in the total cost of the PSEP project presented in this Application. Lateral connections that were replaced were appropriately sized based on the recommendation of the RER and the existing system.
4. Known Substructures: Potholing results confirmed the depth of several large utilities along the replacement alignment. Installing the replacement line above these utilities would have resulted in less than the minimum depth of cover. The Project

Pipeline Safety Enhancement Plan Final Report
Supply Line 37-18 Replacement Project

Team planned for trenchless construction, utilizing slick bores to install the new pipeline under those utilities.

5. Land Use: The Project Team acquired temporary rights to a parking lot adjacent to the construction site to support construction activities and store equipment. The Project Team also utilized the Broadway laydown yard acquired for the Gardena Bundle lines.
6. Tie-In: The south tie-in would be located within private property of the nearby refinery. The replacement also required tie-ins to both Supply Line 37-18-F and Supply Line 37-18-K along 190th Street.
7. Environmental: Work within the refinery was considered high risk for contaminated soil, so a mitigation plan was prepared and reviewed with the Construction Contractor.
8. Relocation: Existing valves and bridle connections located in the middle of 190th Street and Crenshaw Place were planned to be relocated to a private parking lot. Due to unsuccessful negotiations with the parking lot owners, the valves were relocated approximately 200 feet north of the intersection onto Crenshaw Place.
9. Valves: The Project Team replaced three existing MLVs and seven bridle valves by reconfiguring the bridle layout. The new bridle layout allowed for improved isolation and customer service.

D. Scope Changes

Through engineering, design, and planning activities, SoCalGas and SDG&E determined that changes in scope were appropriate for Sections 1, 2, 3, and 4 to enhance the design of the Project and address engineering factors. As a result, the preliminary cost estimate does not fully reflect the final scope. Summarized below are

Pipeline Safety Enhancement Plan Final Report
Supply Line 37-18 Replacement Project

notable changes in scope made after the preliminary cost estimate was developed and approved.

1. Planning and Coordination: The Project Team initially planned one mobilization. To maximize the use of shared construction resources across the Gardena Bundle and install the new pipelines as soon as practicable, the Project Team revised the scope and planned multiple mobilizations to allow for resource flexibility.
2. Engineering & Design: The Project Team revised the design to include a new [REDACTED] ball valve and tee inside of Crenshaw Station at the north tie-in location of Section 1 to allow for constant gas flow through the existing line to allow one lateral to be back-fed. During construction, summer weather conditions were still present, and therefore, the regulator station served by the lateral could be shut-in. The tie-in was modified during construction to remove the tee, and the new valve was installed.

Pipeline Safety Enhancement Plan Final Report
Supply Line 37-18 Replacement Project

III. CONSTRUCTION

A. Construction Contractor Selection

The Project Team prepared an initial cost estimate based on the preliminary design. Following completion of the engineering, design, and planning activities described above, the Project Team directed the Performance Partner to prepare cost estimates based on a more detailed engineering design package, that included the updated design as described in the discussion of notable Scope Changes above. SoCalGas and SDG&E awarded the construction contract to the Performance Partner.

1. SoCalGas and SDG&E’s Preliminary Construction Cost Estimate (confidential):
SoCalGas and SDG&E’s preliminary estimate for construction was [REDACTED].
2. Construction Contractor’s Target Price Estimate (confidential): The Construction Contractor’s cost estimate was [REDACTED], which was [REDACTED] than SoCalGas and SDG&E’s preliminary cost estimate for construction.

B. Construction Schedule

Table 3: Construction Timeline

Sections 1, 2, 3 and 4

Construction Start Date	10/27/2014
Construction Completion Date	05/12/2017
NOP Date	04/22/2017

Sections 5

Construction Start Date	04/24/2017
Construction Completion Date	10/20/2017
NOP Date	09/16/2017

Pipeline Safety Enhancement Plan Final Report
Supply Line 37-18 Replacement Project

C. Changes During Construction

The conditions summarized below were encountered during construction. Activities to address or mitigate these conditions resulted in approximately \$1,240,000 in change orders.

Section 1, 2, 3, and 4

1. Permits Conditions:

- a. The City and County of Los Angeles requested revisions during renewal of permits past a scheduled moratorium, resulting in standby charges for the Construction Contractor while the permit was finalized. Once the permit was available the Construction Contractor completed acquisition.
- b. Caltrans required an extensive review of the permit. This delay in acquiring the permit resulted in a separate mobilization to complete the construction of Section 1. The Project Team nitrogen-filled a portion of the pipeline until the remaining section could be constructed and placed in service.
- c. Delays in acquiring the Los Angeles County construction permit resulted in additional costs to the Construction Contractor.
- d. The Union Pacific Railroad permit for the jack and bore crossing was not available, resulting in a partial demobilization.
- e. The inspector required the Construction Contractor to remove all construction equipment from the street daily for a portion of construction.

Pipeline Safety Enhancement Plan Final Report
Supply Line 37-18 Replacement Project

2. Work Hours: On two occasions during construction city inspectors granted an extended construction window. The Project Team approved overtime for these windows to remediate the delays from the other issues encountered during construction.
 - a. During the moratorium, the Construction Contractor accrued stand by charges for equipment rather than fully demobilizing.
 - b. Extended construction duration resulted in additional costs for Construction Contractor supervision, material and equipment rentals, and overheads, including maintaining the laydown yard.
3. Field Design Change:
 - a. To improve piggability, the Project Team installed robotic pig fittings on the pipeline prior to hydrotesting.
 - b. For Sections 2, 3, and 4, the Project Team installed and tested the fittings and successfully put them into service.
 - c. The Project Team revised installation across an intersection from a bore to an open trench installation to reduce costs, reduce impacts to traffic, and improve future accessibility to the pipeline.
 - d. Interfering utilities and insufficient clearance required extending the south tie-in of Section 3 approximately 15 feet.
4. Other:
 - a. The Construction Contractor supported the SoCalGas and SDG&E Pipeline Integrity group with inspection of tie-in bell holes. Coal tar wrap was encountered, resulting in standby charges during remediation.

Pipeline Safety Enhancement Plan Final Report
Supply Line 37-18 Replacement Project

- b. The Project Team installed a temporary water fill pipe below-grade and provided night watch for the temporary hydrotest fill line and equipment.

Section 5

1. Constructability Issues: Due to overhead powerlines, the bore pit was relocated 80 feet north from the proposed location. Due to the actual locations of existing substructures, the bore pit for Supply Line 37-18 was relocated further south and the bore pits for Supply Line 37-18 K and Supply Line 37-18-F were scaled down from proposed dimensions. This change required different elbows than designed to meet the angle requirements for the condensed receiving pits and additional pipe installation for the longer bore paths from the relocated bore pits.

Pipeline Safety Enhancement Plan Final Report
Supply Line 37-18 Replacement Project

Figure 6: Jack-and-Bore Construction Set Up



Pipeline Safety Enhancement Plan Final Report
Supply Line 37-18 Replacement Project

Figure 7: Replacement Bridle Configuration During Construction



Pipeline Safety Enhancement Plan Final Report
Supply Line 37-18 Replacement Project

D. Commissioning and Site Restoration

Commissioning activities include restoration of the site, final inspection and placement of the pipeline back into service, transportation and disposal of hydrotested water and hazardous material, and site demobilization.

Closeout activities include development of final as-built drawings, finalization of a reconciliation package, and updates to company recordkeeping systems to reflect the completed scope of work.

Pipeline Safety Enhancement Plan Final Report
Supply Line 37-18 Replacement Project

IV. PROJECT COSTS

A. Cost Avoidance Actions

SoCalGas and SDG&E exercised due diligence in the planning, design, and construction activities for this project to minimize or avoid costs when prudent to do so. As discussed above, the Project Team conducted a site visit to identify and incorporate discernible site conditions into the engineering, design, and planning of the Project. Specific examples of cost avoidance actions taken on this project are:

1. Scope Change: Removing the installation of a new valve at the north tie-in of Section 1 from scope reduced the cost of material and construction labor.
2. Materials: Bulk ordering enabled SoCalGas and SDG&E to obtain volume pricing for the [REDACTED] pipe.
3. Planning and Coordination: The Project Team scheduled work for the Gardena Bundle projects in phases, and construction crews moved between the Gardena Bundle projects to minimize downtime.
4. Land Use: The Gardena Bundle projects utilized the same main laydown yard, reducing mobilization and demobilization costs during downtimes. The workspace utilized adjacent to the project site reduced efforts to move and store materials and equipment during construction. Acquiring a workspace adjacent to the construction location resulted in less time and effort spent mobilizing equipment and material for construction.
5. Future Maintenance: The Project Team relocated the valves out of the intersection, allowing for easier and safer access for future maintenance.
6. Construction Execution: Closure of Crenshaw Place for the duration of construction allowed for longer working hours and more workspace, easing construction efforts.

Pipeline Safety Enhancement Plan Final Report
Supply Line 37-18 Replacement Project

B. Cost Estimate

Based on the preliminary design, once the project scope was confirmed and engineering, design, and planning activities were underway, SoCalGas and SDG&E prepared an estimate of the Direct Costs of the Project in the amount of \$40,027,879. This estimate for Section 1, 2, 3, and 4 was prepared in July of 2014, using the “SCG Pipeline Estimate Template Rev 0” estimating tool and for Section 5 in March of 2017 using the “SCG Pipeline Estimate Template Rev 3” estimate tool, the most current versions of the PSEP Estimate Template at the time. The Project Team considered the conditions known at the time to prepare the preliminary Direct Cost estimate. This estimate reflects the projected Labor, Material, and Services costs anticipated to be incurred to execute the Project.

SoCalGas and SDG&E estimated Indirect Costs of the Project based on the estimated Direct Costs and other project-related variables.

C. Actual Direct and Indirect Costs

Actual Direct Costs reflect the Labor, Material, and Service costs incurred to execute the Project. Actual Indirect Costs reflect costs for incremental overhead loaders in accordance with Company overhead allocation policies. The total loaded cost of the Project is \$58,053,699.

Pipeline Safety Enhancement Plan Final Report
Supply Line 37-18 Replacement Project

Table 4: Estimated and Actual Direct Costs and Variances

Direct Costs (\$)	Estimate	Actuals ⁴	Delta Over/(Under)
Company Labor	1,287,668	1,334,817	47,149
Materials	5,041,975	2,456,538	(2,585,437)
Construction Contractor	20,850,555	27,386,381	6,535,826
Construction Management & Support	3,210,589	3,587,523	376,934
Environmental	615,963	537,337	(78,626)
Engineering & Design	3,270,053	5,599,867	2,329,814
Project Management & Services	1,431,302	2,518,613	1,087,311
ROW & Permits	216,480	551,216	334,736
GMA	4,103,294	5,479,418	1,376,124
Total Direct Costs	40,027,879	49,451,710	9,423,831

Table 5: Estimated and Actual Indirect Costs, Total Costs, and Variances

Indirect Costs/Total Costs (\$)	Estimate	Actuals	Delta Over/(Under)
Overheads	2,976,919	4,145,629	1,168,710
AFUDC	4,726,991	4,444,215	(282,776)
Property Taxes	937,700	12,145	(925,555)
Total Indirect Costs	8,641,610	8,601,989	(39,621)
Total Direct Costs	40,027,879	49,451,710	9,423,831
Total Loaded Costs	48,669,489	58,053,699	9,384,210

⁴ Actual Material and Construction Contractor costs exclude the cost of upsizing the pipe.

Pipeline Safety Enhancement Plan Final Report
Supply Line 37-18 Replacement Project

D. Disallowance

There is no disallowance calculation for Supply Line 37-18 Replacement Project as there were no post-1955 segments included in the Project without records that provide the minimum information to demonstrate compliance with then applicable industry standards or regulatory strength testing and recordkeeping requirements.

Pipeline Safety Enhancement Plan Final Report
Supply Line 37-18 Replacement Project

V. CONCLUSION

SoCalGas and SDG&E enhanced the safety of their integrated natural gas transmission system by prudently executing the Supply Line 37-18 Section Replacement Project. Through this Replacement Project, SoCalGas and SDG&E successfully replaced 4.291 miles of pipe and installed five MLVs in the Cities of Inglewood, Hawthorne, Gardena, and Los Angeles. The total loaded cost of the Project is \$58,053,699.

SoCalGas and SDG&E executed this project prudently by removing non-piggable features, designing Section 5 with a jack-and-bore crossing to limit traffic and construction impacts, relocating the bridle connections to a more accessible location, and acquiring a workspace immediately adjacent to the construction location.

SoCalGas and SDG&E engaged in prudent cost avoidance efforts by procuring material through bulk purchasing and coordinating construction activities with five other projects to optimize the efficiency of the construction crews and minimize downtime. SoCalGas and SDG&E safely completed construction along a major thoroughfare and replaced the pipe using a combination of internal and contracted construction management personnel to complete the safety enhancement project as soon as practicable.

End of Supply Line 37-18 Replacement Project Final Report

Pipeline Enhancement Safety Plan Final Project
Final Report for Supply Line 38-200 Replacement Project

I. SUPPLY LINE 38-200 REPLACEMENT PROJECT

A. Background and Summary

Supply Line 38-200 is a predominantly [REDACTED] diameter line that runs approximately 1.199 miles crossing under Highway 99 in the City of Bakersfield. The pipeline is primarily routed across a Class 3 location. This report describes the activities associated with the Supply Line 38-200 Replacement Project, which consists of the replacement of 0.369 miles of pipeline. The specific attributes of this Project are detailed in Table 1 below. The total loaded cost of the Project is \$8,561,624.

Table 1: General Project Information

Project Name	Supply Line 38-200		
Project Type	Replacement		
Length	0.369 miles		
Location	Bakersfield		
Class	3		
MAOP (<i>confidential</i>)	[REDACTED]		
Pipe Vintage	1945		
Construction Start	04/11/2016		
Construction Finish	06/24/2016		
Original Pipe Diameter (<i>confidential</i>)	[REDACTED]		
New Diameter (<i>confidential</i>)	[REDACTED]		
Original SMYS ¹ (<i>confidential</i>)	[REDACTED]		
New SMYS (<i>confidential</i>)	[REDACTED]		
Project Costs (\$)	Capital	O&M	Total
Loaded Project Costs	8,538,965	22,659	8,561,624
Disallowed Costs	-	-	-

¹ Highest percentage of Specified Minimum Yield Strength (SMYS) of Category 4 Criteria pipe.

Pipeline Enhancement Safety Plan Final Project
Final Report for Supply Line 38-200 Replacement Project

B. Maps and Images

Figure 1: Satellite Image of Supply Line 38-200 Replacement Project



Pipeline Enhancement Safety Plan Final Project Final Report for Supply Line 38-200 Replacement Project

Figure 2: Overview Map of Supply Line 38-200 Replacement Project

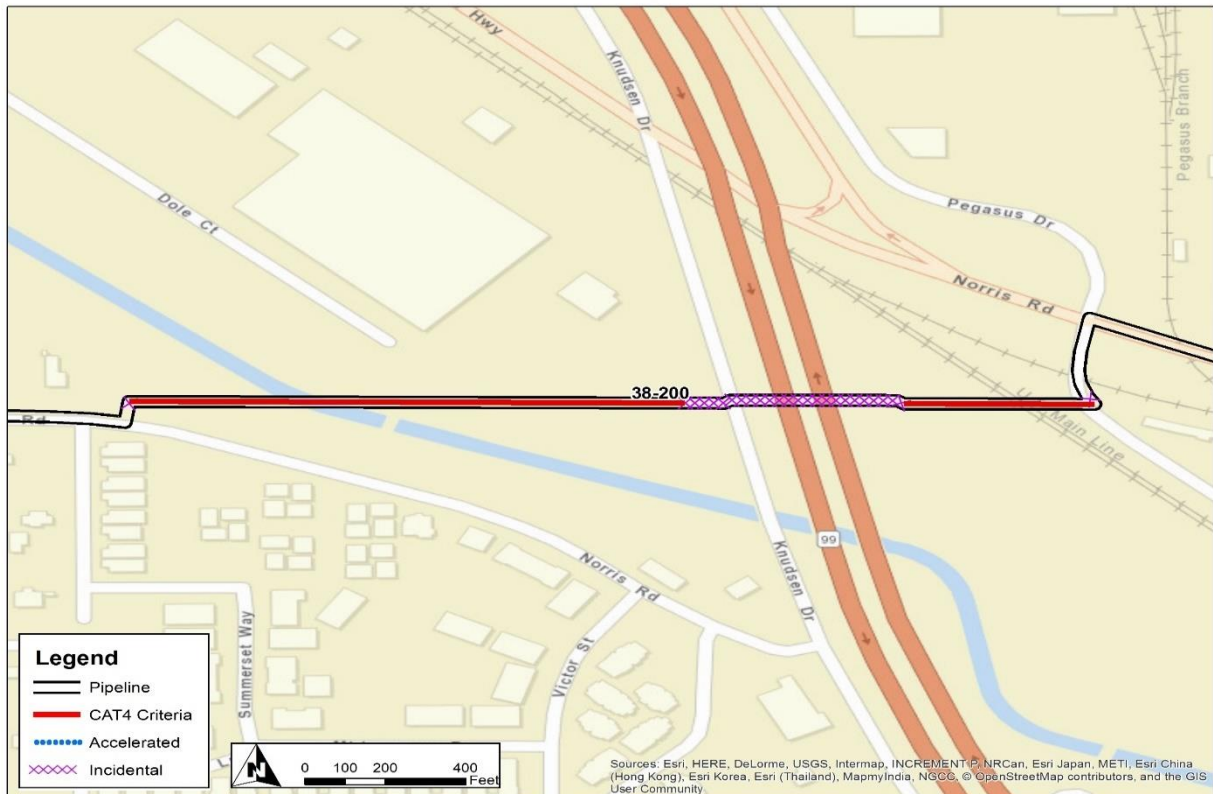

Pipeline Enhancement Safety Plan Final Project
Final Report for Supply Line 38-200 Replacement Project

II. ENGINEERING, DESIGN, AND PLANNING

A. Project Scope

Table 2: Mileage Information

	Criteria	Accelerated	Incidental	New	Total ²
Final Mileage	0.279 mi.	0 mi.	0.086 mi.	0.003 mi.	0.369 mi.
	1,478 ft.	0 ft.	457 ft.	15 ft.	1,950 ft.

SoCalGas and SDG&E presented a conceptual project scope in workpapers supporting the 2011 PSEP filing.³ Prior to initiating execution of the Project in 2016, SoCalGas and SDG&E reviewed existing pipeline records to validate the scope of the Project. During the Engineering, Design, and Planning phase, SoCalGas and SDG&E further refined the scope. This progression of the project scope is summarized as follows:

1. 2011 PSEP Filing⁴: SoCalGas and SDG&E identified Supply Line 38-200 as a Phase 1A Replacement Project comprised of 0.204 miles of Category 4 Criteria pipe.
2. Scope Validation: Through scope validation activities, after the 2011 filing and before initiating execution of the Project, SoCalGas and SDG&E recategorized 403 feet from non-Criteria pipe to Criteria pipe. The scope of this Project would consist of two adjacent, but not contiguous segments that totaled 0.279 miles of Category 4 Criteria pipe.

² Values may not add to total due to rounding.

³ See Amended PSEP of SoCalGas and SDG&E, submitted December 2, 2011, in R.11-02-019 and subsequently transferred to A.11-11-002.

⁴ Mathematical error in 2011 Filing identified 0.233 miles of Category 4 Criteria but was later corrected to 0.204 miles of Category 4 Criteria.

Pipeline Enhancement Safety Plan Final Project
Final Report for Supply Line 38-200 Replacement Project

3. Engineering, Design, and Constructability:

- a. The Project Team planned to take advantage of the existing [REDACTED] pipeline and use it as a casing pipe for the installation of new [REDACTED] pipe to minimize trenching costs. However, an exploratory dig confirmed the existing pipe had external corrosion and would require replacement. This change resulted in an additional 465 feet of Incidental pipe and one continuous [REDACTED] replacement without any casing. SoCalGas and SDG&E decided to abandon the existing line in place and slurry fill it.
- b. SoCalGas and SDG&E replaced the non-piggable stopple fitting with one rather than two stopple fittings as originally designed after determining the Project length warranted only one.
- c. Incidental mileage was included for constructability and replacement of existing pipe with external corrosion.

4. Final Project Scope: The final project scope consisted of a 0.369 mile Replacement using two jack and bores, horizontal direction drill (HDD), and open trench installation. There was no Accelerated mileage and 457 feet of Incidental pipe.

Pipeline Enhancement Safety Plan Final Project
Final Report for Supply Line 38-200 Replacement Project

B. Decision Tree Analysis

SoCalGas and SDG&E performed a PSEP Decision Tree analysis of Supply Line 38-200 and confirmed the project design should commence as a Replacement Project.

For pipeline segments longer than 1,000 feet in length, under the approved PSEP Decision Tree, SoCalGas and SDG&E complete a preliminary review to determine whether SoCalGas and SDG&E can manage customer service impacts if the pipeline segment is taken out of service for a period of two to six weeks to complete pressure testing. Where mitigation of customer impacts to remove the line from service for pressure testing is feasible, SoCalGas and SDG&E compare the costs, constructability, risks, and benefits of pressure testing and replacement to determine whether pressure testing or replacement is the more prudent option.

Through this Decision Tree analysis, SoCalGas and SDG&E identified replacement as the more prudent option. Key considerations that support SoCalGas and SDG&E's determination to replace this segment include:

1. Shut-In Analysis: The Project Team completed a Request for Engineering Review (RER) analysis and concluded the existing line could be shut-in during any season, as long as the loop feeding both sides of the line is not isolated; however, summer conditions are preferred.
2. Pipe Vintage: 1945.
3. Piggability: Non-piggable.
4. Existing Pipe Attributes: Non-piggable features included four short radius elbows, one stopple fitting, and one pressure control fitting (PCF).
5. Longseam Type: Unknown.
6. Longseam Repair History: No identified issues.

Pipeline Enhancement Safety Plan Final Project
Final Report for Supply Line 38-200 Replacement Project

7. Condition of Coating: Pipe Condition and Maintenance Reports stated varying conditions, ranging from no coating damage coating damage and coating condition was between fair and good with damage and fluid underneath.
8. History of Leaks: No identified issues.
9. Other Identified Risks: Non-piggable and the Criteria segments of this supply line, although post 1946, were installed utilizing refurbished pipe from another project. The Project Team assumed the refurbished pipe to be pre-1946 with unverifiable records from the 1948 installation. Based on the unknown features of this pipe, the Project Team determined that replacement was the best option.

C. Engineering, Design, and Planning Factors

SoCalGas and SDG&E reviewed pipeline drawings and other information, contacted internal planning groups, communicated with external stakeholders, conducted survey activities, including reviewing public records, and potholing of the area to confirm the presence of underground utilities and substructures, and completed a pre-design site walk. Key factors that influenced the engineering and design of the Project are as follows:

1. Shut-In Analysis: As discussed above, the Project Team completed a Request for Engineering Review (RER) analysis and concluded the existing line could be shut-in during any season, as long as the loop feeding both sides of the line is not isolated; however, summer conditions are preferred.
2. Customer Impact: Per the RER, SoCalGas and SDG&E could support Core customers using a combination of compressed natural gas (CNG) bottles and pods.

Pipeline Enhancement Safety Plan Final Project
Final Report for Supply Line 38-200 Replacement Project

3. Diameter Changes: Replacement of non-piggable [REDACTED] pipe with piggable [REDACTED] pipe to would provide a uniform [REDACTED] diameter with existing pipeline segments. The RER concluded that an [REDACTED] pipe would handle the capacity needs of the system and the [REDACTED] pipe was no longer needed.
4. Community Impact: Open trench construction methods could potentially cause disruptions, such as the closure of State Route 99, Beardsley Canal, and railroad.
5. Known Substructures: Prior to construction, multiple utilities were identified and included in the Project design.
6. Permit Conditions: The long lead time (e.g. greater than six months) of obtaining the North Kern Water Storage District Beardsley Canal License Agreement and permits for the Union Pacific Railroad and Caltrans permits would dictate the project start.
7. Environmental: The Project Team identified a nesting bird (Killdeer) and contaminated soil in preconstruction surveys.

D. Scope Changes

Through engineering, design and planning activities, SoCalGas and SDG&E determined that changes in scope were appropriate to enhance the design of the Project and address engineering factors. As a result, the preliminary cost estimate does not fully reflect the final scope. Summarized below are notable changes in scope made after the preliminary cost estimate was developed and approved.

This project underwent four design changes with three redesigns prior to construction and one during construction. The three redesigns prior to construction included the first design as a HDD installation that was rejected because of the risk of fracture into an adjacent abandoned oil field.

Pipeline Enhancement Safety Plan Final Project
Final Report for Supply Line 38-200 Replacement Project

The second design utilized the existing pipeline as casing for the insertion of a new pipeline; however, it was rejected after an exploratory dig revealed that based on the condition of the pipe, it could not serve as a casing. The third design utilized three jack and bores and an open trench; however, Caltrans would not allow this crossing method under the highway as summarized below in the Changes During Construction section.

Pipeline Enhancement Safety Plan Final Project
Final Report for Supply Line 38-200 Replacement Project

III. CONSTRUCTION

A. Construction Contractor Selection

The Project Team prepared an initial cost estimate based on the preliminary design. Following completion of the engineering, design and planning activities described above, the Project Team directed the Performance Partner to prepare cost estimates based on a more detailed engineering design package, that included the updated design described in the discussion of notable Scope Changes above.

1. SoCalGas and SDG&E’s Preliminary Construction Cost Estimate (*confidential*):
SoCalGas and SDG&E’s preliminary cost estimate for construction was [REDACTED].
2. Construction Contractor’s Target Price Estimate (*confidential*): The Construction Contractor’s cost estimate was [REDACTED], which was [REDACTED] than SoCalGas and SDG&E’s preliminary cost estimate for construction.

B. Construction Schedule

Table 3: Construction Timeline

Construction Start Date	04/11/2016
Construction Completion Date	06/24/2016
NOP Date	06/14/2016

C. Changes During Construction

The conditions summarized below were encountered during construction. Activities to address or mitigate these conditions resulted in approximately \$241,000 in change orders.

Pipeline Enhancement Safety Plan Final Project
Final Report for Supply Line 38-200 Replacement Project

1. Construction Method: When completing the bore beneath Beardsley Canal, the contractor inspecting the canal requested the use of a slurry mix to fill the annular space opposed to the planned Bentonite filling.

2. Field Design Change:
 - a. During construction, the Construction Contractor identified the canal bottom to be six feet deeper than planned, requiring the pipe to be dropped six feet lower to maintain the 10 foot required clearance from the bottom of the canal. The contractor excavated an additional eight feet deeper on the bore side and an additional 10 feet on the receiving side.

 - b. The bore contractor went on standby when the onsite Caltrans inspector requested a change since a jack and bore drilling method would require the use of a [REDACTED] auger for an [REDACTED] pipe. While a [REDACTED] auger for an [REDACTED] pipe was a normal design, the Caltrans inspector was concerned with the void space. During permitting, Caltrans did not request specifics regarding methods of the trenchless design and only considered a maximum diameter of [REDACTED] for the auger. As a result of the inspector's concern, SoCalGas and SDG&E applied for and received a permit for a HDD rather than a jack and bore.

3. Site Conditions: Geotechnical information indicated that the soils around the bores are non-cohesive, silty sand. While completing the pilot bore, the contractor encountered impenetrable soil which required a more aggressive bore drill head. In addition, once the sacrificial casing was being pushed out, the Construction Contractor encountered clay, requiring water lines to be welded around the pipe to clean out the clay before completing the bore.

Pipeline Enhancement Safety Plan Final Project
Final Report for Supply Line 38-200 Replacement Project

Figure 3: HDD Machine



Pipeline Enhancement Safety Plan Final Project
Final Report for Supply Line 38-200 Replacement Project

Figure 4: Jack and Bore Equipment

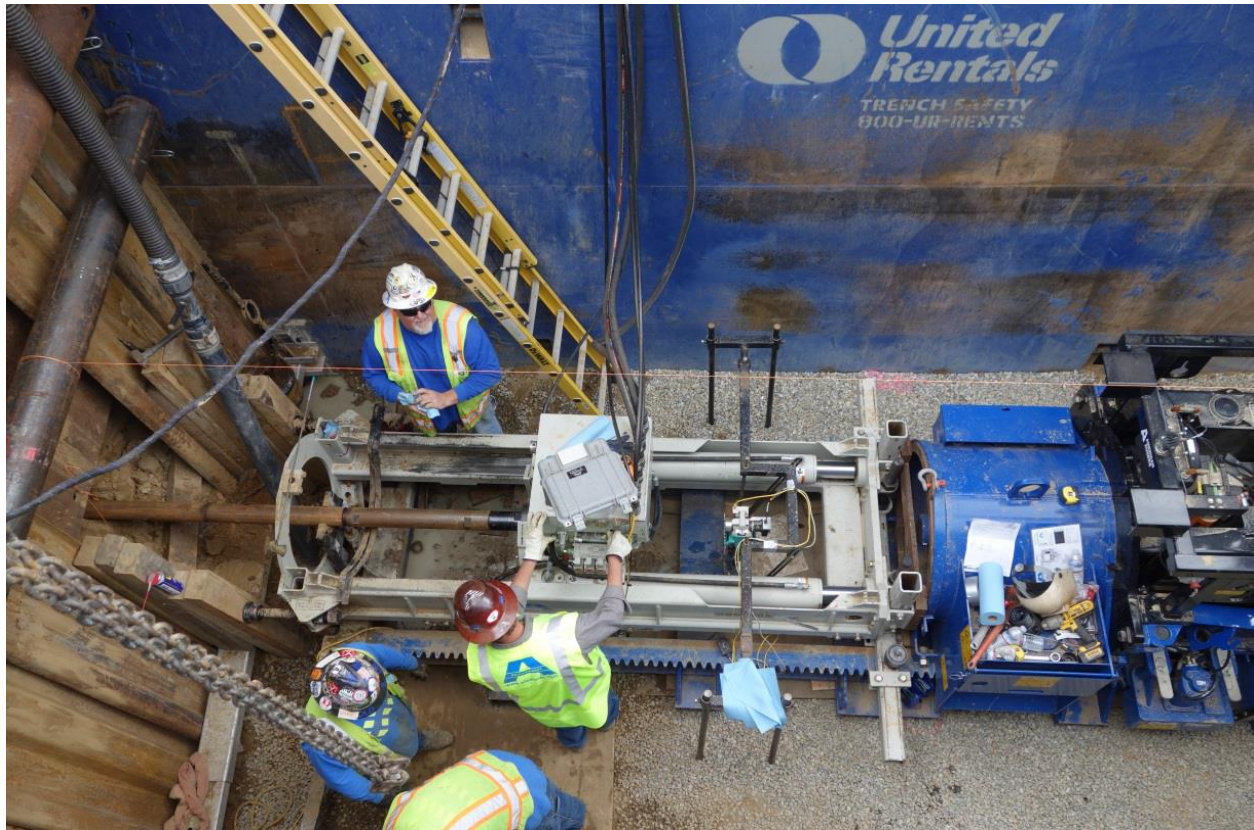

Pipeline Enhancement Safety Plan Final Project Final Report for Supply Line 38-200 Replacement Project

D. Commissioning and Site Restoration

Commissioning activities include restoration of the site, final inspection and placement of the pipeline back into service, transportation and disposal of hydrotested water and hazardous material, and site demobilization. Closeout activities include development of final drawings, finalization of a reconciliation package, and updates to company recordkeeping systems to reflect the completed scope of work.

Pipeline Enhancement Safety Plan Final Project
Final Report for Supply Line 38-200 Replacement Project

IV. PROJECT COSTS

A. Cost Avoidance Actions

SoCalGas and SDG&E exercised due diligence in the planning, design, and construction activities for this project to minimize or avoid costs when prudent to do so. As discussed above, the Project Team conducted a site visit to identify and incorporate discernible site conditions into the engineering, design, and planning of the Project. A cost avoidance action taken on this project was that although the Project experienced some construction delays as described above, the use of the HDD equipment accelerated construction. The Project finished ahead of schedule, resulting in a credit from the Construction Contractor, which helped offset other change order costs.

B. Cost Estimate

Based on the preliminary design, once the project scope was confirmed and engineering, design, and planning activities were underway, SoCalGas and SDG&E prepared an estimate of the Direct Costs of the Project in the amount of \$7,688,686. This estimate was prepared in June of 2015, using the “SCG Pipeline Estimate Template Rev 2.0” estimating tool, the most current version of the PSEP Estimate Template at the time. The Project Team considered the conditions known at the time to prepare the preliminary Direct Cost estimate. This estimate reflects the projected Labor, Material, and Services costs anticipated to be incurred to execute the Project. SoCalGas and SDG&E estimated Indirect Costs of the Project based on the estimated Direct Costs and other project-related variables.

Pipeline Enhancement Safety Plan Final Project
Final Report for Supply Line 38-200 Replacement Project

C. Actual Direct and Indirect Costs

Actual Direct Costs reflect the Labor, Material, and Services costs incurred to execute the Project. Actual Indirect Costs reflect costs for incremental overhead loaders in accordance with Company overhead allocation policies. The total loaded cost of the Project is \$8,561,624.

Table 4: Estimated and Actual Direct Costs and Variances

Direct Costs (\$)	Estimate	Actuals	Delta Over/(Under)
Company Labor	323,633	288,148	(35,485)
Materials	169,478	143,790	(25,688)
Construction Contractor	3,085,864	3,075,146	(10,718)
Construction Management & Support	393,610	431,640	38,030
Environmental	505,732	578,385	72,653
Engineering & Design	1,519,358	1,554,004	34,646
Project Management & Services	752,110	216,666	(535,444)
ROW & Permits	138,649	322,226	183,577
GMA	800,252	864,677	64,425
Total Direct Costs	7,688,686	7,474,682	(214,004)

Table 5: Estimated and Actual Indirect Costs, Total Costs, and Variances

Indirect Costs/Total Costs (\$)	Estimate	Actuals	Delta Over/(Under)
Overheads	701,144	708,280	7,136
AFUDC	100,453	334,889	234,436
Property Taxes	19,397	43,773	24,376
Total Indirect Costs	820,994	1,086,942	265,948
Total Direct Costs	7,688,686	7,474,682	(214,004)
Total Loaded Costs	8,509,680	8,561,624	51,944

Pipeline Enhancement Safety Plan Final Project
Final Report for Supply Line 38-200 Replacement Project

D. Disallowance

There was no disallowance for Supply Line 38-200 as there were no post-1955 segments included in the Project without records that provide the minimum information to demonstrate compliance with then applicable industry standards or regulatory strength testing and recordkeeping requirements.

Pipeline Enhancement Safety Plan Final Project
Final Report for Supply Line 38-200 Replacement Project

V. CONCLUSION

SoCalGas and SDG&E enhanced the safety of their integrated natural gas transmission system by prudently executing the Supply Line 38-200 Replacement Project. Through this Replacement Project, SoCalGas and SDG&E successfully replaced 0.369 miles of pipe in the City of Bakersfield. The total loaded cost of the Project is \$8,561,624.

SoCalGas and SDG&E executed this prudently through designing this project to safely cross under Highway 99 and a canal while mitigating and minimizing customer and community impacts, avoiding costs through design changes to reduce material usage, accelerating the construction schedule, and improving the piggability of the line.

SoCalGas and SDG&E engaged in prudent cost avoidance efforts by using a reasonable amount of company and contractor resources given the complex scope of work.

End of Supply Line 38-200 Replacement Project Final Report

Pipeline Safety Enhancement Plan Final Report
Supply Line 38-501 Replacement Project

I. SUPPLY LINE 38-501 REPLACEMENT PROJECT

A. Background and Summary

Supply Line 38-501 is a predominantly [REDACTED] diameter transmission line in a mixed area comprised of farmland, commercial, and residential properties that runs approximately 15 miles along Highway 41 in Kings County to Fresno County. The pipeline is primarily routed across Class 1 and 2 locations and traverses some Class 3 locations. This report describes the activities associated with the Supply Line 38-501 Replacement Project that consists of the replacement of 2.441 miles of pipeline including approximately one mile installed through two horizontal directional drills (HDD). The specific attributes for this Project are detailed in Table 1 below. The total loaded cost of the Project is \$22,345,339.

Pipeline Safety Enhancement Plan Final Report
Supply Line 38-501 Replacement Project

Table 1: General Project Information

Project Name		Supply Line 38-501 Section 1		
Project Type		Replacement		
Length		0.321 miles		
Location		Fresno County		
Class		3		
MAOP (<i>confidential</i>)		[REDACTED]		
Pipe Vintage		1951		
Construction Start		06/29/2015		
Construction Finish		09/11/2015		
Original Pipe Diameter (<i>confidential</i>)		[REDACTED]		
New Diameter (<i>confidential</i>)		[REDACTED]		
Original SMYS ¹ (<i>confidential</i>)		[REDACTED]		
New SMYS (<i>confidential</i>)		[REDACTED]		
Project Name		Supply Line 38-501 Section 2		
Project Type		Replacement		
Length		2.120 miles		
Location		City of Lemoore and Kings County		
Class		3		
MAOP (<i>confidential</i>)		[REDACTED]		
Predominant Pipe Vintage		1952		
Construction Start		08/15/2016		
Construction Finish		12/19/2016		
Original Pipe Diameter (<i>confidential</i>)		[REDACTED]		
New Diameter (<i>confidential</i>)		[REDACTED]		
Original SMYS ² (<i>confidential</i>)		[REDACTED]		
New SMYS (<i>confidential</i>)		[REDACTED]		
Project Costs (\$)		Capital	O&M	Total
Loaded Project Costs		22,338,591	6,748	22,345,339
Disallowed Costs		-	-	-

¹ Highest percentage of Specified Minimum Yield Strength (SMYS) of Category 4 Criteria pipe.

² Ibid

Pipeline Safety Enhancement Plan Final Report
Supply Line 38-501 Replacement Project

B. Maps and Images

Figure 1: Satellite Image of Supply Line 38-501 Section 1 and Section 2 Replacement Projects

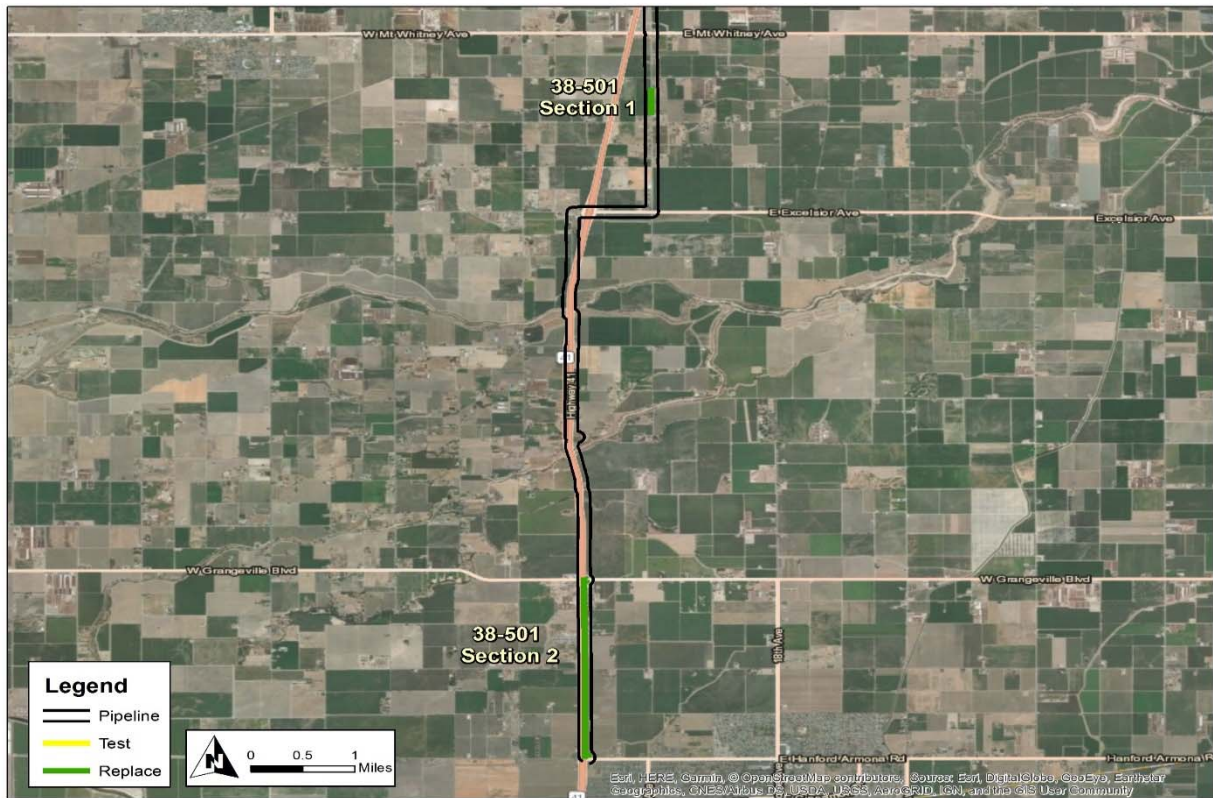

Pipeline Safety Enhancement Plan Final Report
Supply Line 38-501 Replacement Project

Figure 2: Satellite Image of Supply Line 38-501 Section 1 Replacement Project

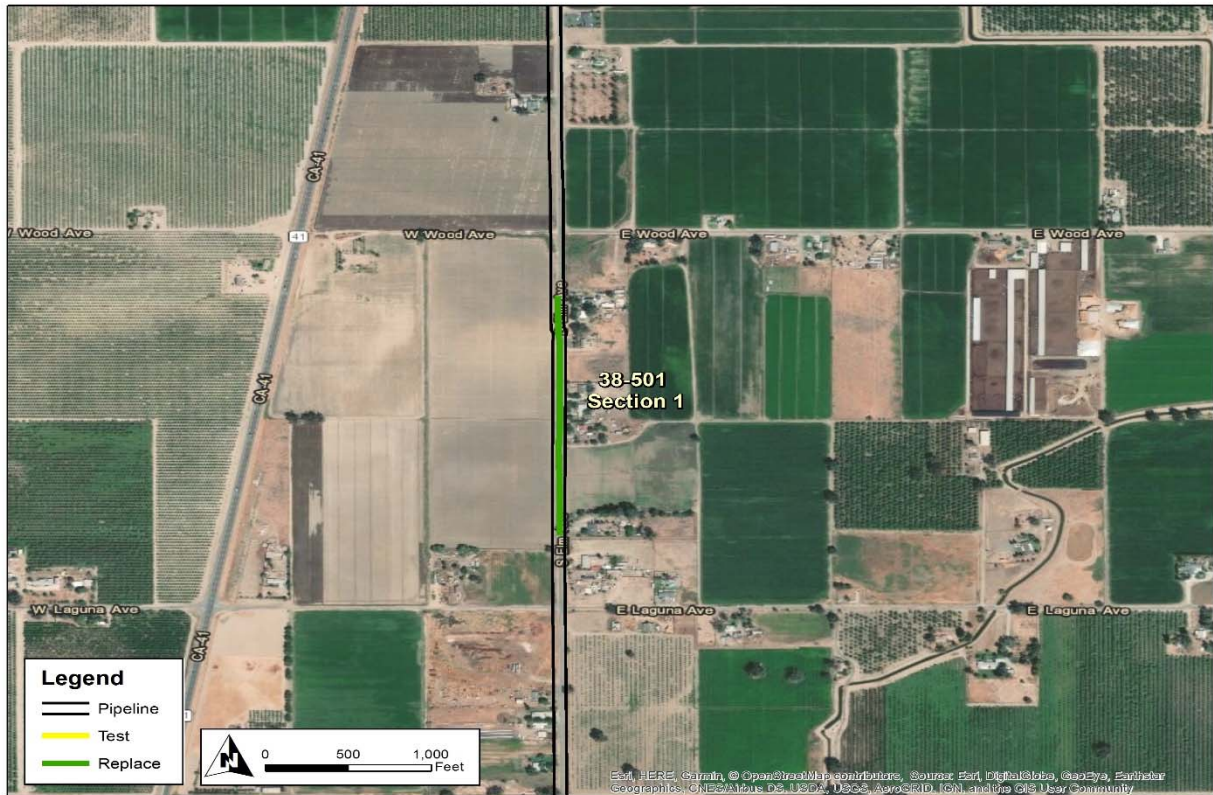

Pipeline Safety Enhancement Plan Final Report
Supply Line 38-501 Replacement Project

Figure 3: Overview Map of Supply Line 38-501 Section 1 Replacement Project

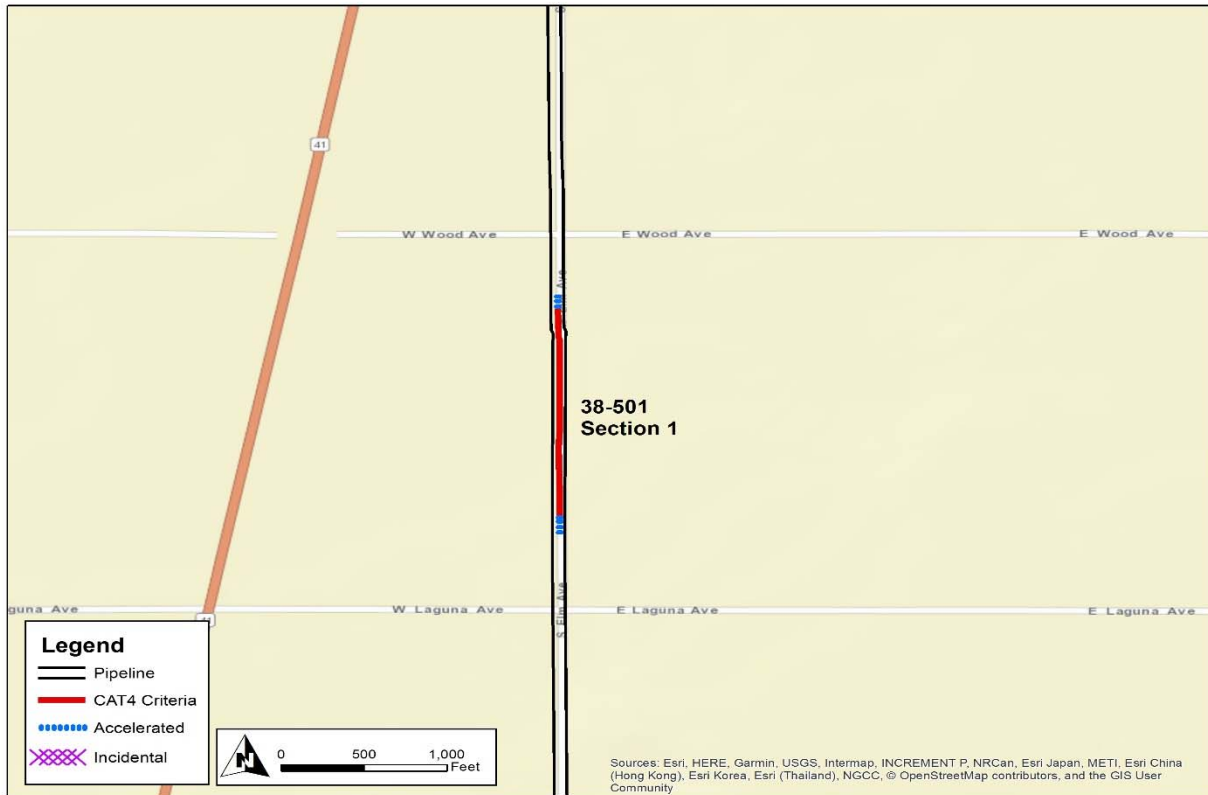

Pipeline Safety Enhancement Plan Final Report
Supply Line 38-501 Replacement Project

Figure 4: Satellite Image of Supply Line 38-501 Section 2 Replacement Project

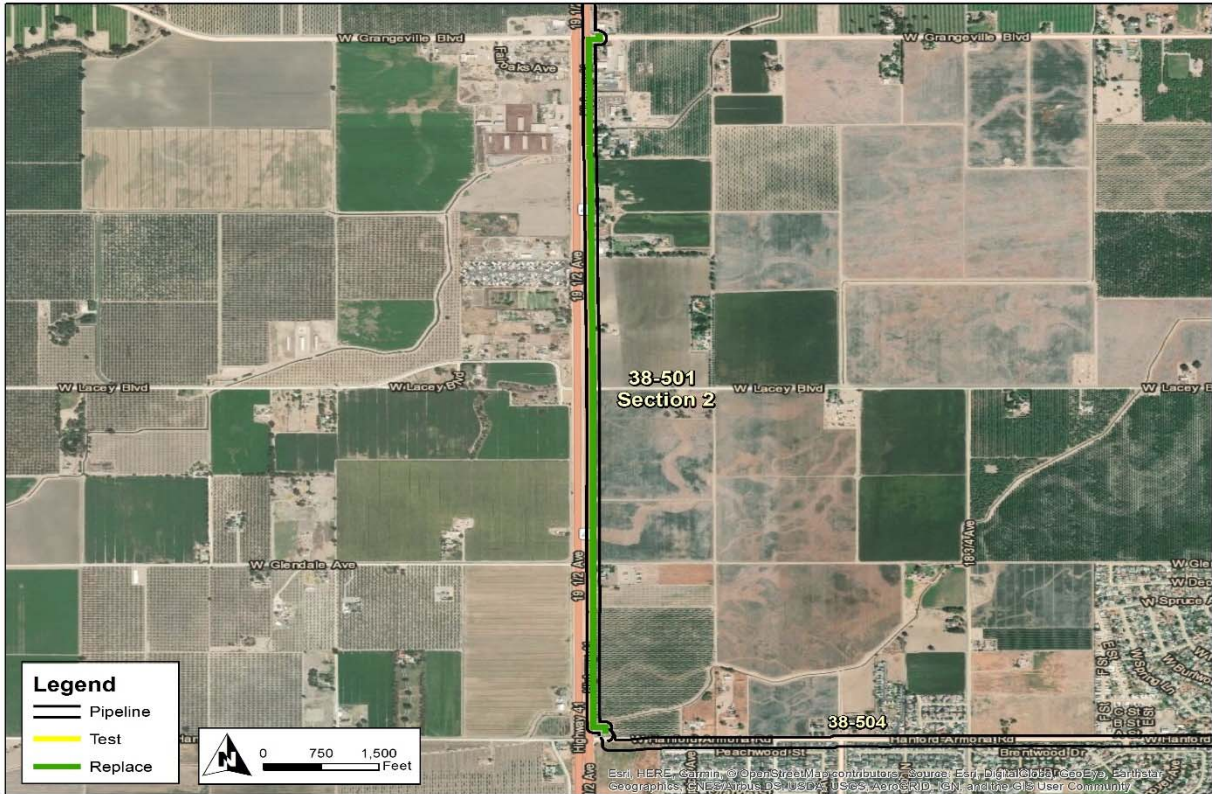

Pipeline Safety Enhancement Plan Final Report
Supply Line 38-501 Replacement Project

Figure 5: Overview Map of Supply Line 38-501 Section 2 Replacement Project

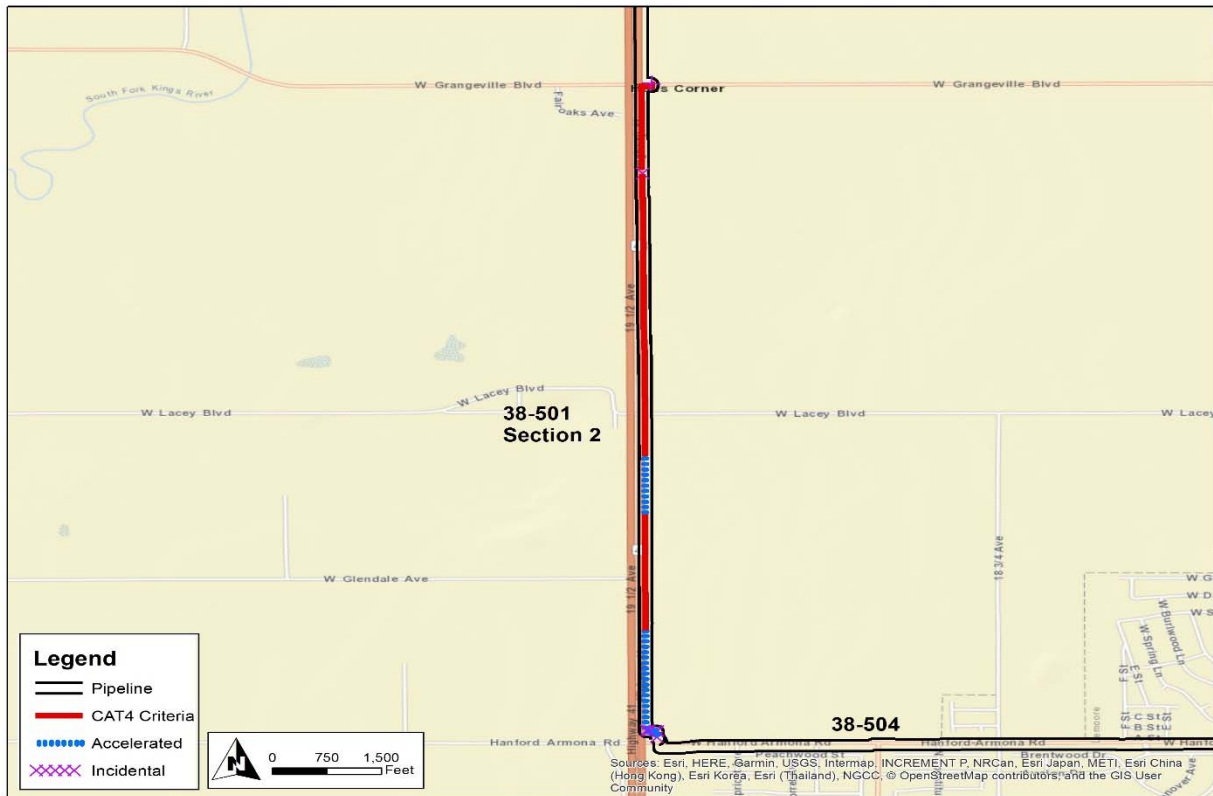

Pipeline Safety Enhancement Plan Final Report
Supply Line 38-501 Replacement Project

II. ENGINEERING, DESIGN, AND PLANNING

A. Project Scope

Table 2: Mileage Information

	Criteria	Accelerated ³	Incidental	New	Total ⁴
Final Mileage	1.793 mi.	0.574 mi.	0.050 mi.	0.025 mi.	2.441 mi.
	9,465 ft.	3,028 ft.	262 ft.	134 ft.	12,889 ft.

SoCalGas and SDG&E presented a conceptual project scope in workpapers supporting the 2011 PSEP filing.⁵ Prior to initiating execution of the Project in 2015, SoCalGas and SDG&E reviewed existing pipeline records to validate the scope of the Project. During the Engineering, Design, and Planning phase, SoCalGas and SDG&E further refined the scope. The progression of project scope is summarized as follows:

1. 2011 PSEP Filing: SoCalGas and SDG&E identified Supply Line 38-501 as a Phase 1A Replacement Project comprised of 1.147 miles of Category 4 Criteria pipe and 0.838 miles of Accelerated pipe.
2. Scope Validation: Through scope validation activities, after the 2011 filing and before initiating execution of the Project, SoCalGas and SDG&E increased the scope of the Project by 0.637 miles of Category 4 Criteria pipe.

³ Accelerated mileage includes Phase 1B, Phase 2A, and Phase 2B pipe. Phase 2 includes pipelines without sufficient record of a pressure test in less populated areas (Phase 2A) or pipelines with record of a pressure test, but without record of a pressure test to modern – Subpart J – standards (Phase 2B). The Accelerated mileage was included to realize efficiencies and to enhance project constructability.

⁴ Values may not add to total due to rounding.

⁵ See Amended PSEP of SoCalGas and SDG&E, submitted December 2, 2011, in R.11-02-019 and subsequently transferred to A.11-11-002.

Pipeline Safety Enhancement Plan Final Report
Supply Line 38-501 Replacement Project

3. Engineering, Design, and Constructability:

- a. The Project Team split the Project into two sections, based on the non-contiguous location of the Category 4 Criteria pipe.
 - i. The Section 1 Replacement consists of the Replacement of a 0.280 mile Category 4 Criteria segment.
 - ii. The Section 2 Replacement consists of the Replacement of a 1.504 mile Category 4 Criteria segment.
- b. The Project Team included 0.574 miles of Accelerated pipe. Accelerated mileage is pipe that would otherwise be addressed in Phase 2, however was advanced within this scope to realize operating and cost efficiencies. SoCalGas maximized efficiencies by addressing these 0.574 miles of Accelerated Phase 2 pipe while the pipeline was taken out of service and thereby eliminated the need for a future Phase 2 project with the associated costs and community impacts.
- c. The Project Team included Incidental mileage on Section 2 because the tie-in points needed to extend beyond the limits of the Category 4 Criteria Pipe.
- d. The Project Team added New pipe to both sections to allow for an offset alignment.

4. Final Project Scope: The final project scope consists of a 2.441 mile Replacement with approximately 5,700 feet installed through HDD and approximately 100 feet installed through a bore. The Accelerated mileage consists of 103 feet of Phase 1B pipe, 0.530 miles of Phase 2A pipe, and 130 feet of Phase 2B pipe.

Pipeline Safety Enhancement Plan Final Report
Supply Line 38-501 Replacement Project

B. Decision Tree Analysis

SoCalGas and SDG&E performed a PSEP Decision Tree analysis of Supply Line 38-501 and confirmed the project design should commence as a Replacement Project.

For pipeline segments longer than 1,000 feet in length, under the approved PSEP Decision Tree, SoCalGas and SDG&E complete a preliminary review to determine whether SoCalGas and SDG&E can manage customer service impacts if the pipeline segment is taken out of service for a period of two to six weeks to complete pressure testing. Where mitigation of customer impacts to remove the line from service for pressure testing is feasible, SoCalGas and SDG&E compare the costs, constructability, risks and benefits of pressure testing and replacement to determine whether pressure testing or replacement is the more prudent option.

Through this Decision Tree analysis, SoCalGas and SDG&E identified replacement as the more prudent option. Key considerations that support SoCalGas and SDG&E's determination to replace this segment include:

1. Shut-In Analysis: The Project Team completed a Request for Engineering Review (RER) analysis and concluded that Supply Line 38-501 cannot be isolated and shut-in because it is the main source of gas from the Lemoore area to supply customers in Fresno County.
2. Customer Impacts: The Project Team would need to transfer existing taps to the new line once installed.
3. Community Impacts: No identified issues.
4. Permit Conditions: No identified issues.
5. Piggability: Non-piggable.

Pipeline Safety Enhancement Plan Final Report
Supply Line 38-501 Replacement Project

6. Pipe Vintage: 1952.
7. Existing Pipe Attributes: Pipeline contained seven miter bends and two known gouge locations.
8. Longseam Type: Electric Resistance Weld.
9. Longseam Repair History: No identified issues.
10. Condition of Coating: No identified issues.
11. History of Leaks: No identified issues.

C. Engineering, Design, and Planning Factors

SoCalGas and SDG&E reviewed pipeline drawings and other information, contacted internal planning groups, communicated with external stakeholders, conducted survey activities, including reviewing public records and potholing of the area to confirm the presence of underground utilities and substructures, and completed a pre-design site walk. Key factors that influenced the engineering and design of the Project are as follows:

Section 1 and Section 2

1. Diameter Changes: The Project Team replaced the existing [REDACTED] line with a [REDACTED] line based on the recommendation of the RER and to standardize the pipeline for future pigging purposes.

Pipeline Safety Enhancement Plan Final Report
Supply Line 38-501 Replacement Project

2. Land Use:

- a. The Project Team shared the laydown yard at State Route 41 and Hanford Armona Road with the Supply Line 44-687 and Supply Line 38-512 Replacement Projects.

Section 1

1. Customer Impacts: Per the RER, the line could not be shut-in. The Project Team designed a temporary stopple bypass at both the north and south tie-in locations. This allowed the Project Team to maintain gas flow to all customers throughout the duration of construction.

Section 2

1. Customer Impacts: Per the RER, the line could not be shut-in.
 - a. To maintain feed during tie-ins at Lemoore Junction, at the south tie-in point, the Project Team designed two temporary bypass connections; one to feed Supply Line 38-501 and one from Supply Line 38-501-B01 with a temporary regulator station and filter to feed Supply Line 38-512.
 - b. To maintain feed to the system during the north tie-ins, three pressure control fittings (PCFs) with bypasses were utilized to connect Supply Line 38-501 with Supply Line 38-501-B and maintain feed to Supply Line 38-501.
 - c. To avoid service disruption to customers, at the recommendation of the RER, the Project Team chose to derate the existing line to medium pressure rather than transfer the customers to the new line.

Pipeline Safety Enhancement Plan Final Report
Supply Line 38-501 Replacement Project

2. Community Impacts: The Project Team planned construction activities to limit the impacts from traffic control plans.
3. Schedule Coordination: The Project Team coordinated design efforts to relocate the existing bridle assembly between Supply Line 44-687 and Supply Line 38-501 during construction of the Supply Line 44-687 Replacement Project. The relocation of the bridle assembly reduced the overall risk to construction of the Supply Line 38-501 Replacement Project by locating the tie-ins to the new bridle assembly in a safer location further from the road and accommodating the Supply Line 38-501 shut-in restrictions.
4. Known Substructures: The Project Team updated the design at the north and south tie-ins based on potholing results to accommodate the field verified depth and location of the existing utilities.
5. Environmental:
 - a. The Project Team identified a private drinking well that could become contaminated during the HDD activities. Additional measures were planned to avoid contamination. The well owner relocated it prior to construction.
 - b. The Project Team anticipated several areas of potentially contaminated soil based on records and planned for verification prior to construction to limit remediation efforts during construction.
6. Valves: The Project Team installed one new [REDACTED] valve to Supply Line 38-504, one new [REDACTED] valve to Supply Line 38-512, a new [REDACTED] MLV, and two new [REDACTED] bridle valves to the blow off at Lemoore Junction.

Pipeline Safety Enhancement Plan Final Report
Supply Line 38-501 Replacement Project

- a. The Project Team required three [REDACTED] valves for temporary connections at Lemoore junction during tie-in procedures to maintain service to Supply Line 38-512.
7. Land Use: The Project Team required multiple private easements to install the replacement pipe due to unsuccessful negotiations with Caltrans.
8. Constructability: The Project Team designed two HDD sections into the new alignment, approximately 3,100 feet and 2,600 feet long. Utilizing an HDD installation reduced the time and cost that otherwise would have been required to remove obstructions from the Right of Way (ROW) for construction. The Project Team required one jack and bore installation to cross a Caltrans ROW.
 - a. The Project Team would not be able to tie over existing taps within the bounds of the HDD. This supported the decision to derate the existing pipeline to medium pressure to provide service to existing customers.
9. Permit Conditions: A portion of the replacement alignment that crossed Lacy Boulevard was within Kings County ROW and Caltrans ROW. The Project Team designed the crossings with a jack and bore to meet the required depth of installation by Caltrans and not impede traffic onto State Route 41.

Pipeline Safety Enhancement Plan Final Report
 Supply Line 38-501 Replacement Project

Figure 6: Supply Line 38-501 Section 2 Replacement Project Schematic

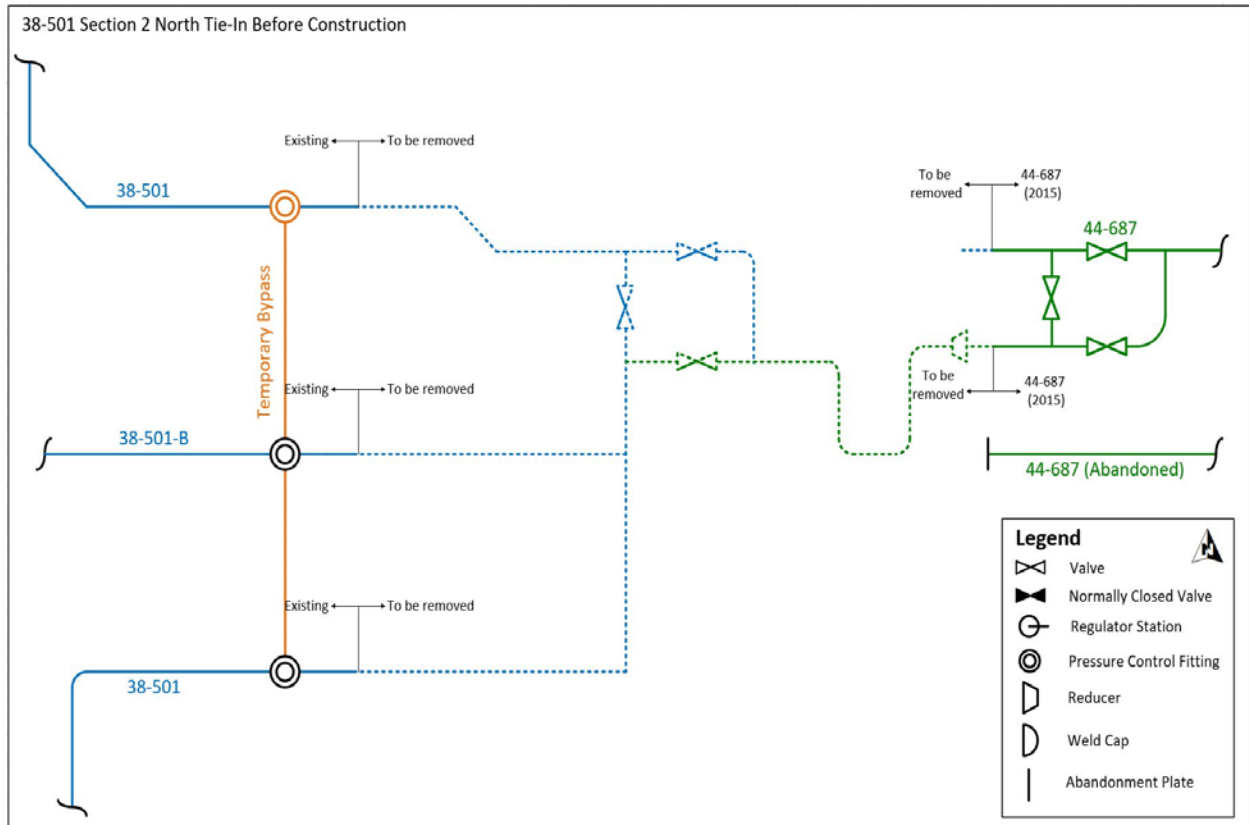

Pipeline Safety Enhancement Plan Final Report
Supply Line 38-501 Replacement Project

Figure 7: Supply Line 38-501 Section 2 Replacement Project Schematic

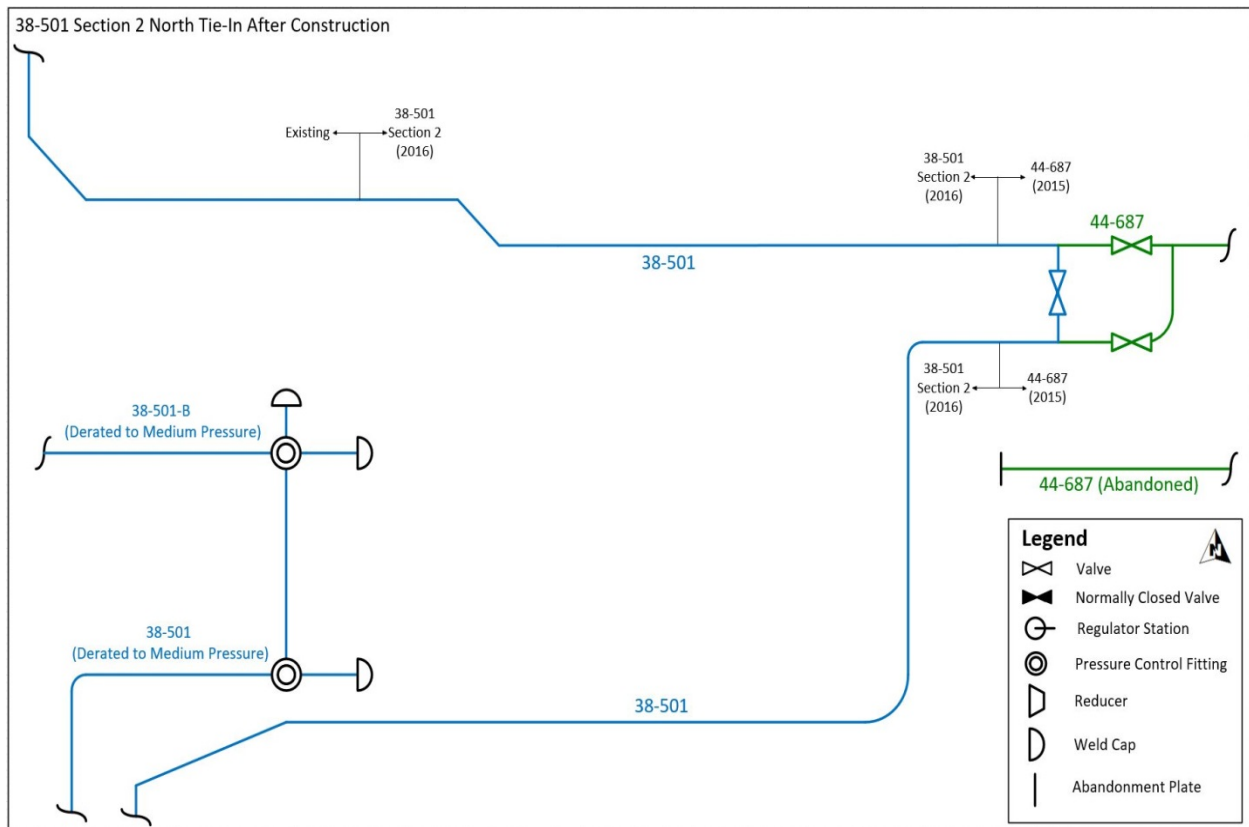

Pipeline Safety Enhancement Plan Final Report
Supply Line 38-501 Replacement Project

Figure 8: Supply Line 38-501 Section 2 Replacement Project Schematic

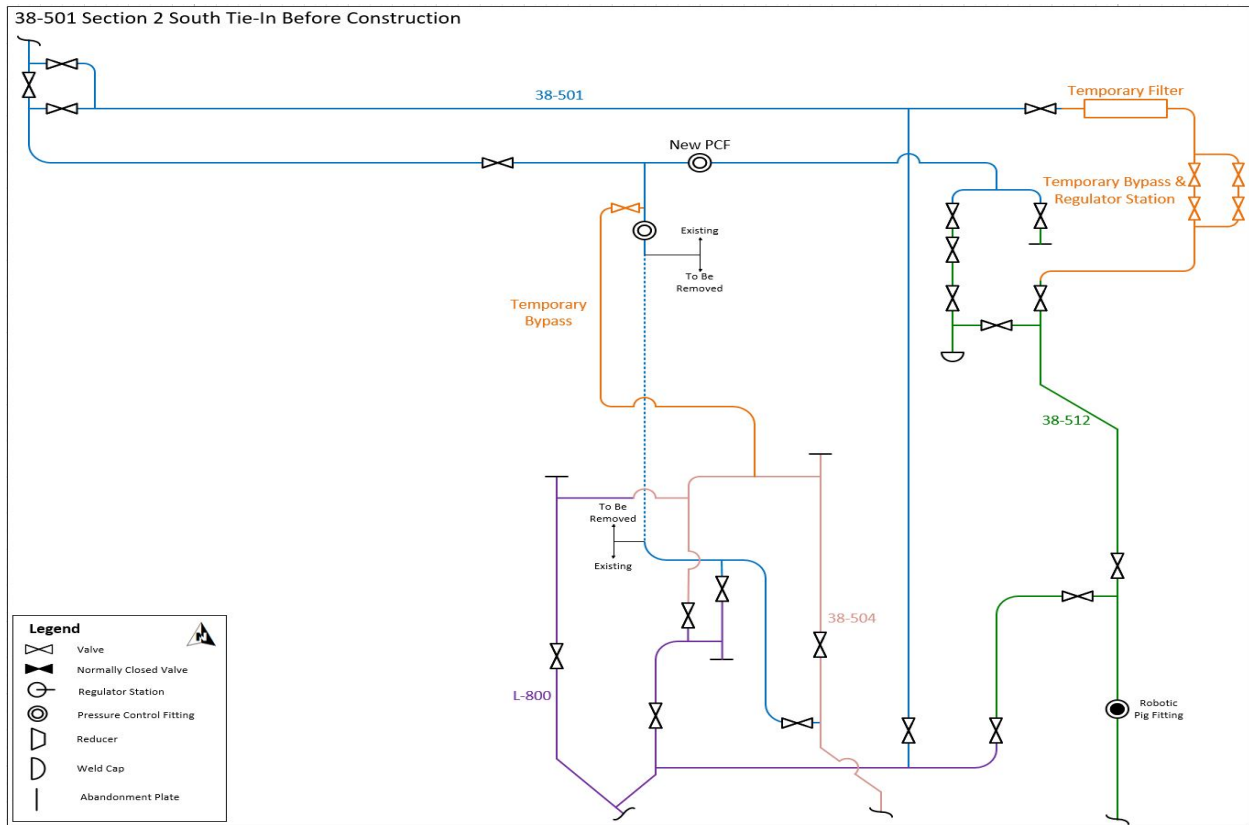

Pipeline Safety Enhancement Plan Final Report
Supply Line 38-501 Replacement Project

Figure 9: Supply Line 38-501 Section 2 Replacement Project Schematic

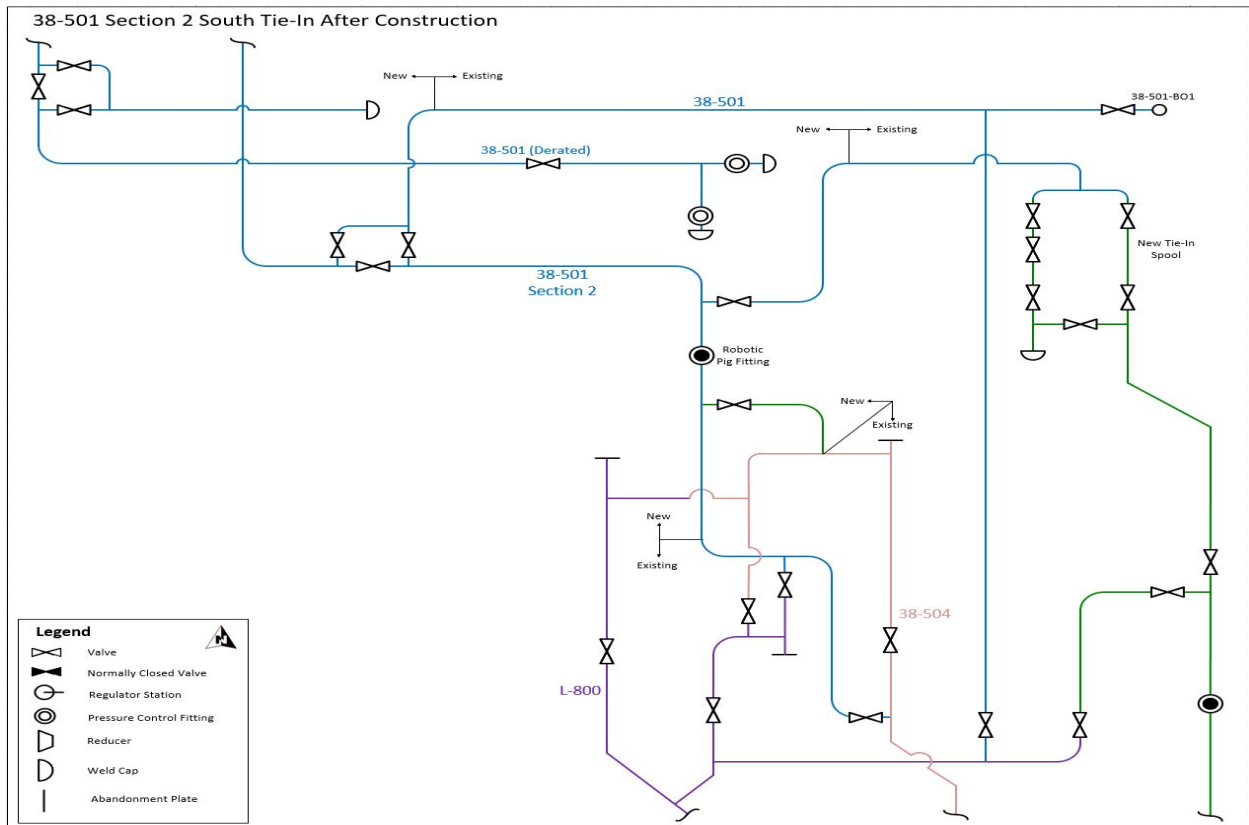

Pipeline Safety Enhancement Plan Final Report
Supply Line 38-501 Replacement Project

C. Scope Changes

SoCalGas and SDG&E did not make any notable scope changes during detailed design.

Pipeline Safety Enhancement Plan Final Report
Supply Line 38-501 Replacement Project

III. CONSTRUCTION

A. Construction Contractor Selection

The Project Team prepared an initial cost estimate based on the preliminary design. Following completion of the engineering, design, and planning activities described above, the Project Team directed the Performance Partner to prepare cost estimates based on a more detailed engineering design package. As indicated above, there were no notable changes in scope between the time when the Project Team prepared the preliminary cost estimate and when the Performance Partner prepared and submitted its Target Price Estimate. SoCalGas and SDG&E awarded the construction contract to the Performance Partner.

1. SoCalGas and SDG&E’s Preliminary Construction Cost Estimate (confidential):

SoCalGas and SDG&E’s preliminary cost estimate for construction was

██████████

2. Construction Contractor’s Target Price Estimate (confidential): The Construction

Contractor’s cost estimate was ██████████, which was ██████████ than SoCalGas and SDG&E’s preliminary cost estimate for construction.

B. Construction Schedule

Table 3: Construction Timeline

Section 1	
Construction Start Date	06/29/2015
Construction Completion Date	09/11/2015
NOP Date	08/27/2015
Section 2	
Construction Start Date	08/15/2016
Construction Completion Date	12/19/2016
NOP Date	11/17/2016

Pipeline Safety Enhancement Plan Final Report
Supply Line 38-501 Replacement Project

C. Changes During Construction

The conditions summarized below were encountered during construction. Activities to address or mitigate these conditions resulted in approximately \$520,000 in change orders.

Section 1

1. Schedule Delays:

- a. The Operating District required two tests for the south PCF, and the pipe for the north PCF was out of round resulting in issues sealing the pipe. During these issues, the Construction Contractor encountered standby charges.
- b. Pipe within the planned PCF location required repair and the PCF was relocated. The Operating District completed the repair with the support of the Construction Contractor. Due to delays to complete the repair, the Construction Contractor experienced additional equipment rental charges.

Section 2

1. Schedule Delays: The Project Team required revisions to the gas handling plans resulting in an extension to the schedule. To remediate the schedule delay, the Project Team approved overtime for the Construction Contractor to meet the original project schedule.

Pipeline Safety Enhancement Plan Final Report
Supply Line 38-501 Replacement Project

2. Constructability:

- a. Existing guy wires were in conflict with the proposed alignment. The Construction Contractor worked on other sections of construction while the utility agent removed the guy wires. The Construction Contractor completed these sections once the conflict was resolved resulting in additional cost to return to previous locations of construction.
- b. The Construction Contractor relocated a bore pit for one of the HDDs to fit equipment onto state owned property. The relocation required land agreements and permitting resulting in delays to the schedule. The Project Team approved overtime to minimize impact to the schedule.

Pipeline Safety Enhancement Plan Final Report
Supply Line 38-501 Replacement Project

Figure 10: Elm Avenue During Construction



Pipeline Safety Enhancement Plan Final Report
Supply Line 38-501 Replacement Project

Figure 11: Backfilling the Pipeline Trench



Pipeline Safety Enhancement Plan Final Report
Supply Line 38-501 Replacement Project

D. Commissioning and Site Restoration

Commissioning activities include restoration of the site, final inspection and placement of the pipeline back into service, transportation and disposal of hydrotested water and hazardous material, and site demobilization. Closeout activities include development of final drawings, finalization of a reconciliation package, and updates to company recordkeeping systems to reflect the completed scope of work.

Pipeline Safety Enhancement Plan Final Report
Supply Line 38-501 Replacement Project

IV. PROJECT COSTS

A. Cost Avoidance Actions

SoCalGas and SDG&E exercised due diligence in the planning, design, and construction activities for this project to minimize or avoid costs when prudent to do so. As discussed above, the Project Team conducted a site visit to identify and incorporate discernible site conditions into the engineering, design, and planning of the Project. Specific examples of cost avoidance actions taken on this project are:

1. Planning and Coordination: Coordination with the Supply Line 44-687 Replacement Project allowed for tie-in procedures without the need to shut in the existing pipelines, reducing costs for gas handling and support during tie-in operations.
2. Materials: Bulk ordered pipe provided volume pricing for the [REDACTED] pipe.
3. Future Maintenance:
 - a. Avoided future maintenance and tie-over labor costs of service taps by converting the existing pipeline to medium pressure allowing the Project Team to utilize the HDDs to avoid conflict with existing obstacles.
 - b. Avoided future maintenance costs by removing the regulators at each customer tap.
4. Land Use: The Project Team shared a laydown yard at State Route 41 and Hanford Armona Road with Supply Line 44-687 and Supply Line 38-512 Replacement Projects.

Pipeline Safety Enhancement Plan Final Report
Supply Line 38-501 Replacement Project

B. Cost Estimate

Based on the preliminary design, once the project scope was confirmed and engineering, design, and planning activities were underway, SoCalGas and SDG&E prepared an estimate of the Direct Costs of the Project in the amount of \$22,271,344. This estimate for Section 1 was prepared in April of 2015, using the “SCG Pipeline Estimate Template Rev 2” estimating tool, the most current version of the PSEP Estimate Template at the time. The estimate for Section 2 was prepared August of 2016 using the “SCG Pipeline Estimate Template Rev 3” estimating tool, the most current version of the PSEP Estimate Template at the time. The Project Team considered the conditions known at the time to prepare the preliminary Direct Cost estimate. This estimate reflects the projected Labor, Material, and Services costs anticipated to be incurred to execute the Project.

SoCalGas and SDG&E estimated Indirect Costs of the Project based on the estimated Direct Costs and other project-related variables.

C. Actual Direct and Indirect Costs

Actual Direct Costs reflect the Labor, Material and Service costs incurred to execute the Project. Actual Indirect Costs reflect costs for incremental overhead loaders in accordance with Company overhead allocation policies. The total loaded cost of the Project is \$22,345,339.

Pipeline Safety Enhancement Plan Final Report
Supply Line 38-501 Replacement Project

Table 4: Estimated and Actual Direct Costs and Variances

Direct Costs (\$)	Estimate	Actuals	Delta Over/(Under)
Company Labor	1,133,750	669,675	(464,075)
Materials	2,452,652	842,953	(1,609,699)
Construction Contractor	11,160,054	9,787,584	(1,372,470)
Construction Management & Support	1,274,548	2,138,120	863,572
Environmental	769,174	595,917	(173,257)
Engineering & Design	2,727,063	2,642,189	(84,874)
Project Management & Services	1,125,489	511,916	(613,573)
ROW & Permits	415,974	606,051	190,077
GMA	1,212,640	2,314,569	1,101,929
Total Direct Costs	22,271,344	20,108,974	(2,162,370)

Table 5: Estimated and Actual Indirect Costs, Total Costs, and Variances

Indirect Costs/Total Costs (\$)	Estimate	Actuals	Delta Over/(Under)
Overheads	1,739,363	1,913,163	173,800
AFUDC	1,000,333	285,536	(714,797)
Property Taxes	233,685	37,666	(196,019)
Total Indirect Costs	2,973,381	2,236,365	(737,016)
Total Direct Costs	22,271,344	20,108,974	(2,162,370)
Total Loaded Costs	25,244,725	22,345,339	(2,899,386)

D. Disallowance

There was no disallowance for Supply Line 38-501 as there were no post-1955 segments included in the Project without records that provide the minimum information to demonstrate compliance with industry standards or regulatory strength testing and recordkeeping requirements.

Pipeline Safety Enhancement Plan Final Report
Supply Line 38-501 Replacement Project

V. CONCLUSION

SoCalGas and SDG&E enhanced the safety of their integrated natural gas transmission system by prudently executing the Supply Line 38-501 Replacement Project. Through this Replacement Project, SoCalGas and SDG&E successfully replaced 2.441 miles of pipe in Fresno County and Kings County. The total loaded cost of the Project is \$22,345,339.

SoCalGas and SDG&E executed this project prudently by utilizing material that was ordered in bulk and readily available for use, sharing a laydown yard across multiple projects, planning temporary bypasses to maintain customer service, coordinating the bridge design and replacement with another project to reduce impact to the system during tie-ins, and installing the pipe with HDDs to avoid existing at grade conflicts in the alignment.

SoCalGas and SDG&E engaged in prudent cost avoidance efforts by mitigating the field design changes encountered during construction to reduce the cost impact to the Project, hydro-mulching during restoration to quickly return properties to their property owners, derating a portion of the existing line, and removing the regulators at each customer tap, reducing long term maintenance.

End of Supply Line 38-501 Final Report

Pipeline Safety Enhancement Plan Final Report
Supply Line 38-504 Replacement Project

I. SUPPLY LINE 38-504 REPLACEMENT PROJECT

A. Background and Summary

Supply Line 38-504 is a predominantly [REDACTED] diameter transmission line that runs approximately 0.3 miles crossing under Highway 43 within the City of Hanford and unincorporated Kings County. The pipeline is routed across a Class 3 location. This report describes the activities associated with the Supply Line 38-504 Replacement Project that consists of the replacement of 0.377 miles of pipeline. The specific attributes of this Project are detailed in Table 1 below. The total loaded cost of the Project is \$5,720,324.

Table 1: General Project Information

Project Name	Supply Line 38-504		
Project Type	Replacement		
Length	0.377 miles		
Location	City of Hanford and unincorporated Kings County		
Class	3		
MAOP (<i>confidential</i>)	[REDACTED]		
Pipe Vintage	1952		
Construction Start	09/06/2016		
Construction Finish	10/28/2016		
Original Pipe Diameter (<i>confidential</i>)	[REDACTED]		
New Diameter (<i>confidential</i>)	[REDACTED]		
Original SMYS ¹ (<i>confidential</i>)	[REDACTED]		
New SMYS (<i>confidential</i>)	[REDACTED]		
Project Costs (\$)	Capital	O&M	Total
Loaded Project Costs	5,713,631	6,693	5,720,324
Disallowed Costs	-	-	-

¹ Highest percentage of Specified Minimum Yield Strength (SMYS) of Category 4 Criteria pipe.

Pipeline Safety Enhancement Plan Final Report
Supply Line 38-504 Replacement Project

B. Maps and Images

Figure 1: Satellite Image of Supply Line 38-504 Replacement

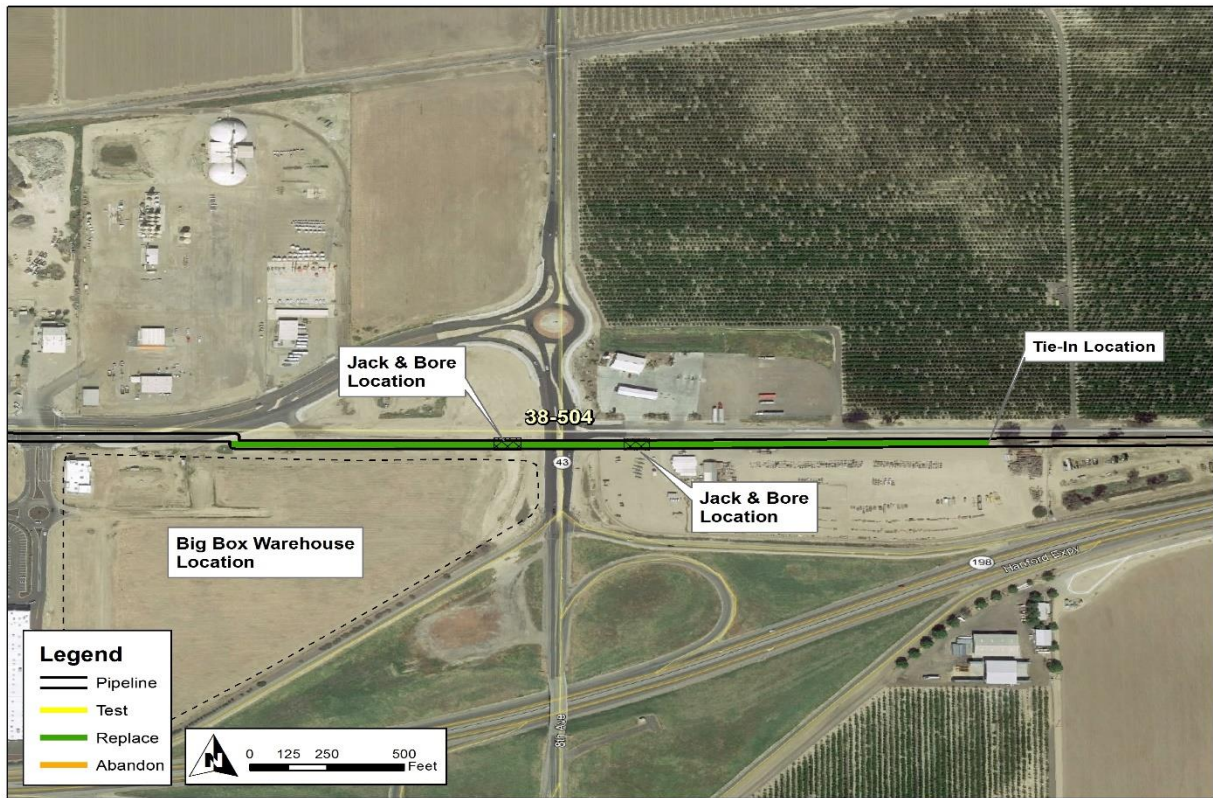

Pipeline Safety Enhancement Plan Final Report Supply Line 38-504 Replacement Project

Figure 2: Overview Map of Supply Line 38-504 Replacement Project

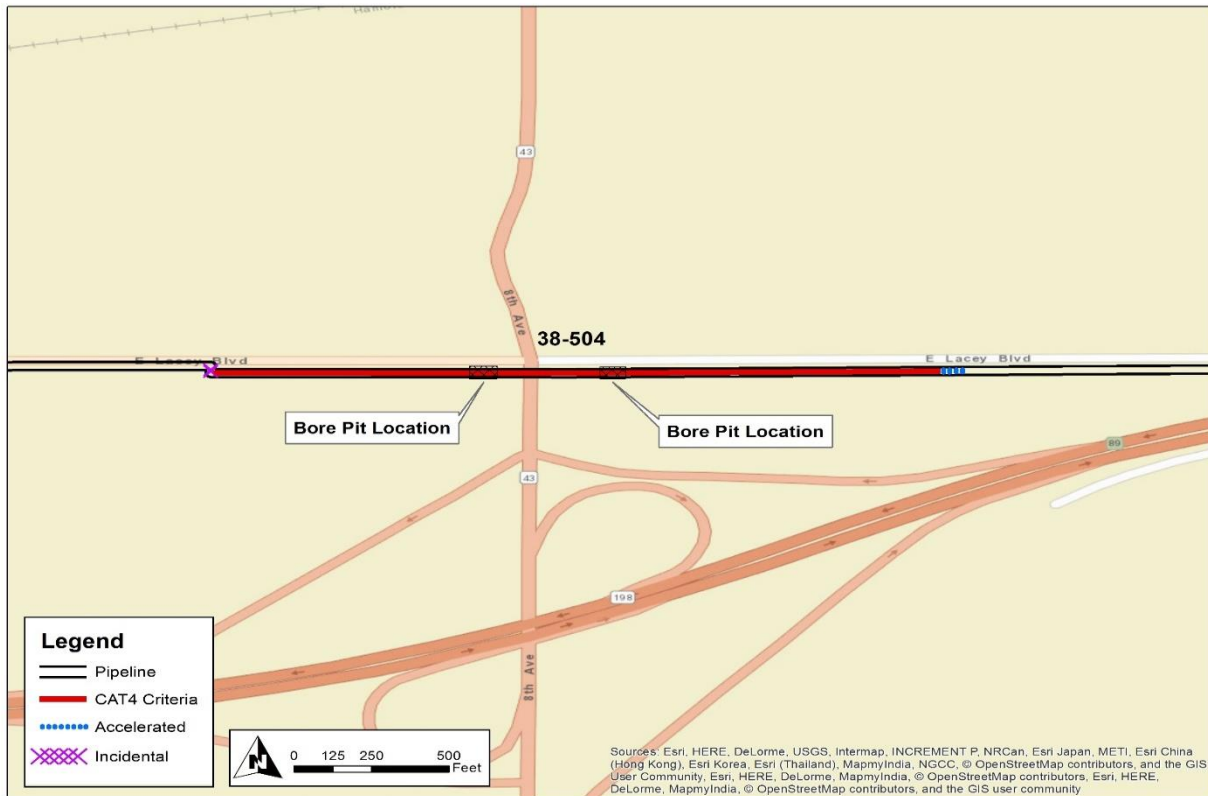

Pipeline Safety Enhancement Plan Final Report
Supply Line 38-504 Replacement Project

II. ENGINEERING, DESIGN, AND PLANNING

A. Project Scope

Table 2: Mileage Information

	Criteria	Accelerated ²	Incidental	New	Total ³
Final Mileage	0.357 mi.	0.012 mi.	0.004 mi.	0.004 mi.	0.377 mi.
	1,884 ft.	63 ft.	21 ft.	23 ft.	1,992 ft.

SoCalGas and SDG&E presented a conceptual project scope in workpapers supporting the 2011 PSEP filing.⁴ Prior to initiating execution of the Project in 2016, SoCalGas and SDG&E reviewed existing pipeline records to validate the scope of the Project. During the Engineering, Design, and Planning phase, SoCalGas and SDG&E further refined the scope. This progression of the project scope is summarized as follows:

1. 2011 PSEP Filing: SoCalGas and SDG&E did not identify Supply Line 38-504 in the 2011 PSEP filing.
2. Scope Validation: Through scope validation activities, after the 2011 filing and before initiating execution of the Project, SoCalGas and SDG&E identified 0.357 miles of Category 4 Criteria pipe and added this as a PSEP Phase 1A project.

² Accelerated mileage includes Phase 2A. Phase 2A includes pipelines without sufficient record of a pressure test in less populated areas. The Accelerated mileage was included to realize efficiencies and to enhance project constructability.

³ Values may not add to total due to rounding.

⁴ See Amended PSEP of SoCalGas and SDG&E, submitted December 2, 2011, in R.11-02-019 and subsequently transferred to A.11-11-002.

Pipeline Safety Enhancement Plan Final Report
Supply Line 38-504 Replacement Project

3. Engineering, Design, and Constructability:
 - a. As engineering and design progressed, the Project Team identified 63 feet of Accelerated pipe and 21 feet of Incidental pipe to the scope for constructability.
 - b. The Project consisted of the replacement of [REDACTED] pipe with approximately 0.369 miles of [REDACTED] and a [REDACTED] transition piece.
 - c. The new pipe alignment resulted in an offset of 23 feet of New pipe.
 - d. All work was constructed via open trench, except for 275 feet under Highway 43, that was replaced via jack and bore.
4. Final Project Scope: The final project scope consists of a 0.377 mile Replacement. The Accelerated mileage consisted of 0.012 miles of Phase 2A pipe and 0.004 miles of Incidental pipe.

B. Decision Tree Analysis

SoCalGas and SDG&E performed a PSEP Decision Tree analysis of Supply Line 38-504 and confirmed the project design should commence as a Replacement Project.

For pipeline segments longer than 1,000 feet in length, under the approved PSEP Decision Tree, SoCalGas and SDG&E complete a preliminary review to determine whether SoCalGas and SDG&E can manage customer service impacts if the pipeline segment is taken out of service for a period of two to six weeks to complete pressure testing. Where mitigation of customer impacts to remove the line from service for pressure testing is feasible, SoCalGas and SDG&E compare the costs, constructability, risks, and benefits of pressure testing and replacement to determine whether pressure testing or replacement is the more prudent option.

Pipeline Safety Enhancement Plan Final Report
Supply Line 38-504 Replacement Project

Through this Decision Tree analysis, SoCalGas and SDG&E identified replacement as the more prudent option. Key considerations that support SoCalGas and SDG&E's determination to replace this segment include:

1. Customer Impact: The isolation of Supply Line 38-504 would primarily impact high pressure customers tapped off Supply Line 38-515, which is fed via Supply Line 38-504 on the western side of the isolation section.
2. Piggability: Non-piggable.
3. Pipe Vintage: 1952.
4. Long Seam Type: Unknown
5. Long Seam Repair History: No identified issues.
6. Condition of Coating: No identified issues.
7. History of Leaks: No identified issues.
8. Site Observations: Adjacent to the project site was on-going construction of a new "big box" warehouse. The City of Hanford imposed a moratorium on street work in the area to lessen the community impacts.

C. Engineering, Design, and Planning Factors

SoCalGas and SDG&E reviewed pipeline drawings and other information, contacted internal planning groups, communicated with external stakeholders, conducted survey activities, including reviewing public records, potholing and ground penetrating radar of the area to confirm the presence of underground utilities and substructures, and completed a pre-design site walk. Key factors that influenced the engineering and design of the Project are as follows:

Pipeline Safety Enhancement Plan Final Report Supply Line 38-504 Replacement Project

1. System Analysis: The original existing pipeline had a [REDACTED] diameter. SoCalGas and SDG&E analyzed typical load demands and future capacity planning for a replacement diameter of [REDACTED] and determined it to be sufficient. The Operating District funded the cost for upsizing of the line. It is not included in the total cost of the PSEP project.
2. Known Substructures: The Project Team slot trenched prior to the start of construction to determine if activities associated with the proposed replacement work would impact the city's future sidewalk work or nearby existing utilities. As a result of the slot trenching, the Project Team identified obstructions and made adjustments to accommodate the existing features.
3. Schedule Coordination: A future "Big Box" warehouse project imposed a schedule constraint that required completion of the pipeline work by a certain date. To ensure the activities associated to the proposed replacement work did not conflict with the City's moratorium, slot trenching was completed several months before construction to avoid interferences between the Project design and the City's road plans.
4. Environmental:
 - a. A eucalyptus tree at the east end of the Project potentially required cutting as it was within the vicinity of the pipe trench;
 - b. Bird surveying during nesting bird season if it coincided with the Project's construction schedule.

D. Scope Changes

SoCalGas and SDG&E did not make any notable scope changes during detailed design.

Pipeline Safety Enhancement Plan Final Report
Supply Line 38-504 Replacement Project

III. CONSTRUCTION

A. Construction Contractor Selection

The Project Team prepared an initial cost estimate based on the preliminary design. Following completion of the engineering, design, and planning activities described above, the Project Team directed the Performance Partner to prepare cost estimates based on a more detailed engineering design package, that included the updated design as described in the discussion of notable Scope Changes above. SoCalGas and SDG&E awarded the construction contract to the Performance Partner.

1. SoCalGas and SDG&E's Preliminary Construction Cost Estimate (*confidential*): SoCalGas and SDG&E's preliminary cost estimate for construction was [REDACTED].
2. Construction Contractor's Target Price Estimate (*confidential*): The Construction Contractor's cost estimate was [REDACTED], which was [REDACTED] than SoCalGas and SDG&E's preliminary cost estimate for construction.

B. Construction Schedule

Table 3: Construction Timeline

Construction Start Date	09/06/2016
Construction Completion Date	10/28/2016
NOP Date	10/19/2016

C. Changes During Construction

SoCalGas and SDG&E successfully mitigated field conditions in a manner that minimized potential impacts on project scope cost and schedule. As result, these conditions did not result in any notable change orders.

Pipeline Safety Enhancement Plan Final Report
Supply Line 38-504 Replacement Project

1. Constructability Issues: The Construction Contractor encountered several alignment conflicts in the field. To avoid these conflicts, the Project Team proposed a new alignment, that moved construction activities away from these obstructions.
2. Substructures: During excavation activities, the Construction Contractor encountered a three inch unidentified line. To avoid the unidentified line, the Construction Contractor installed a box sag to create a vertical offset, creating a clearance of approximately two feet between the unidentified line and the replacement pipeline.
3. Tie-In: During the final tie-in on the west end, the sealing element on the stopple machine was impeded by excessive metal shavings embedded into the sealing element that were left behind after tapping operations. This required the Construction Contractor to replace the sealing element and do one more sweep of the pipe. For safety reasons, and time constraints, the final tie-in operation was completed the following day and traffic control was required.

Pipeline Safety Enhancement Plan Final Report Supply Line 38-504 Replacement Project

Figure 3: Fit Up in Process to [REDACTED] Bottom Out Stopple Fitting



Pipeline Safety Enhancement Plan Final Report
Supply Line 38-504 Replacement Project

Figure 4: Closure Plate Installation on Abandoned [REDACTED] Supply Line



Pipeline Safety Enhancement Plan Final Report Supply Line 38-504 Replacement Project

Figure 5: Backfill and Warning Mesh



Pipeline Safety Enhancement Plan Final Report
Supply Line 38-504 Replacement Project

D. Commissioning and Site Restoration

Commissioning activities include restoration of the site, final inspection and placement of the pipeline back into service, transportation and disposal of hydrotested water and hazardous material, and site demobilization. Closeout activities include development of final drawings, finalization of a reconciliation package, and updates to company recordkeeping systems to reflect the completed scope of work.

Pipeline Safety Enhancement Plan Final Report
Supply Line 38-504 Replacement Project

IV. PROJECT COSTS

A. Cost Avoidance Actions

SoCalGas and SDG&E exercised due diligence in the planning, design, and construction activities for this project to minimize or avoid costs when prudent to do so. As discussed above, the Project Team conducted a site visit to identify and incorporate discernible site conditions into the engineering, design, and planning of the Project. A specific example of Construction Execution cost avoidance action taken on this project was slot trenching, which is the process of digging narrow trenches. Slot trenching confirmed the extent of the Project was outside of the City's moratorium area, avoiding the potential cost of an 80-foot replacement that would have been required to move the project out of the anticipated area.

B. Cost Estimates

Based on the preliminary design, once the project scope was confirmed and engineering, design and planning activities were underway, SoCalGas and SDG&E prepared an estimate of the Direct Costs of the Project in the amount of \$5,294,343. This estimate was prepared in May of 2016, using the "SCG Pipeline Estimate Template Rev 3" estimating tool, the most current version of the PSEP Estimate Template at the time. The Project Team considered the conditions known at the time to prepare the preliminary Direct Cost estimate. This estimate reflects the projected Labor, Material, and Services costs anticipated to be incurred to execute the Project.

SoCalGas and SDG&E estimated Indirect Costs of the Project based on the estimated Direct Costs and other project related variables.

Pipeline Safety Enhancement Plan Final Report
Supply Line 38-504 Replacement Project

C. Actual Direct and Indirect Costs

Actual Direct Costs reflect the Labor, Material, and Service costs incurred to execute the Project. Actual Indirect Costs reflect costs for incremental overhead loaders in accordance with Company overhead allocation policies. The total loaded cost of the Project is \$5,720,324.

Table 4: Estimated and Actual Direct Costs and Variances

Direct Costs (\$)	Estimate	Actuals ⁶	Delta Over/(Under)
Company Labor	318,318	217,068	(101,250)
Materials	285,507	235,132	(50,375)
Construction Contractor	2,122,405	1,813,362	(309,043)
Construction Management & Support	308,840	378,451	69,611
Environmental	199,915	134,436	(65,479)
Engineering & Design	1,213,266	1,494,680	281,414
Project Management & Services	290,542	177,812	(112,730)
ROW & Permits	74,246	90,879	16,633
GMA	481,304	589,523	108,219
Total Direct Costs	5,294,343	5,131,343	(163,000)

Table 5: Estimated and Actual Indirect Costs, Total Costs, and Variances

Indirect Costs/Total Costs (\$)	Estimate	Actuals	Delta Over/(Under)
Overheads	448,242	466,465	18,223
AFUDC	165,333	108,397	(56,936)
Property Taxes	35,978	14,119	(21,859)
Total Indirect Costs	649,553	588,981	(60,572)
Total Direct Costs	5,294,343	5,131,343	(163,000)
Total Loaded Costs	5,943,896	5,720,324	(223,572)

⁶ Actual Material and Construction Contractor costs exclude the cost of upsizing the pipe

Pipeline Safety Enhancement Plan Final Report
Supply Line 38-504 Replacement Project

D. Disallowance

There was no disallowance for the Supply Line 38-504 Replacement Project as there were no post-1955 segments included in the Project without records that provide the minimum information to demonstrate compliance with then applicable industry standards or regulatory strength testing and recordkeeping requirements.

Pipeline Safety Enhancement Plan Final Report
Supply Line 38-504 Replacement Project

V. CONCLUSION

SoCalGas and SDG&E enhanced the safety of their integrated natural gas transmission system by prudently executing the Supply Line 38-504 Replacement Project. Through this Replacement Project, SoCalGas and SDG&E successfully replaced 0.377 miles of pipeline in the City of Hanford. The total loaded cost of the Project is \$5,720,324.

SoCalGas and SDG&E executed this project prudently by close coordination with the City, identifying risks early on, and mitigating these risks by implementing a plan that was developed prior to construction.

SoCalGas and SDG&E engaged in prudent cost avoidance efforts by engaging in scope validation efforts that reduced project mileage, slot trenching to confirm line location with respect to City's moratorium area and avoiding unnecessary installation costs, and responding to numerous unanticipated field conditions. These included unidentified substructures and coordinating schedules with other projects to avoid community impacts.

End of Supply Line 38-504 Replacement Project Final Report

Pipeline Safety Enhancement Plan Final Report
Supply Line 38-512 Replacement Project

I. SUPPLY LINE 38-512 REPLACEMENT PROJECT

A. Background and Summary

Supply Line 38-512 is a [REDACTED] diameter transmission line that runs approximately 4.9 miles along heavily-trafficked Hanford Armona Road in Kings County and the City of Lemoore. The pipeline is primarily routed across a Class 3 location and traverses some Class 2 locations. This report describes the activities associated with the Supply Line 38-512 Replacement Project, which consists of the replacement and reroute of 4.960 miles of pipeline. The specific attributes for this Project are detailed in Table 1 below. The total loaded cost of the Project is \$32,133,994.

Due to a repaving moratorium in Kings County, the Project schedule was separated into Sections 1 and Section 2 so that construction on the section in Kings County could be accelerated and the site restored before the moratorium period. Protracted negotiations with the railroad regarding this permit put completion of Section 1 within the time limits imposed by the moratorium at risk. Section 3 was subsequently split off and constructed later because a very short segment of Section 1 required a railroad license agreement that was not received in a timely manner.

Pipeline Safety Enhancement Plan Final Report
Supply Line 38-512 Replacement Project

Table 1: General Project Information

Project Name		Supply Line 38-512 Section 1 and 2		
Project Type		Replacement		
Length		4.919 miles		
Location		Kings County and City of Lemoore		
Class		3		
MAOP (<i>confidential</i>)		[REDACTED]		
Pipe Vintage		1929		
Construction Start		03/16/2015		
Construction Finish		12/01/2015		
Original Pipe Diameter (<i>confidential</i>)		[REDACTED]		
New Diameter (<i>confidential</i>)		[REDACTED]		
Original SMYS ¹ (<i>confidential</i>)		[REDACTED]		
New SMYS (<i>confidential</i>)		[REDACTED]		
Project Name		Supply Line 38-512 Section 3		
Project Type		Replacement		
Length		220 feet		
Location		Kings County		
Class		3		
MAOP (<i>confidential</i>)		[REDACTED]		
Pipe Vintage		1929		
Construction Start		09/18/2017		
Construction Finish		10/13/2017		
Original Pipe Diameter (<i>confidential</i>)		[REDACTED]		
New Diameter (<i>confidential</i>)		[REDACTED]		
Original SMYS ² (<i>confidential</i>)		[REDACTED]		
New SMYS (<i>confidential</i>)		[REDACTED]		
Project Costs (\$)		Capital	O&M	Total
Loaded Project Costs		30,889,268	1,244,726	32,133,994
Disallowed Costs		-	-	-

¹ Highest percentage of Specified Minimum Yield Strength (SMYS) of Category 4 Criteria pipe.

² Ibid.

Pipeline Safety Enhancement Plan Final Report
Supply Line 38-512 Replacement Project

B. Maps and Images

Figure 1: Satellite Image of the Supply Line 38-512 Replacement Project

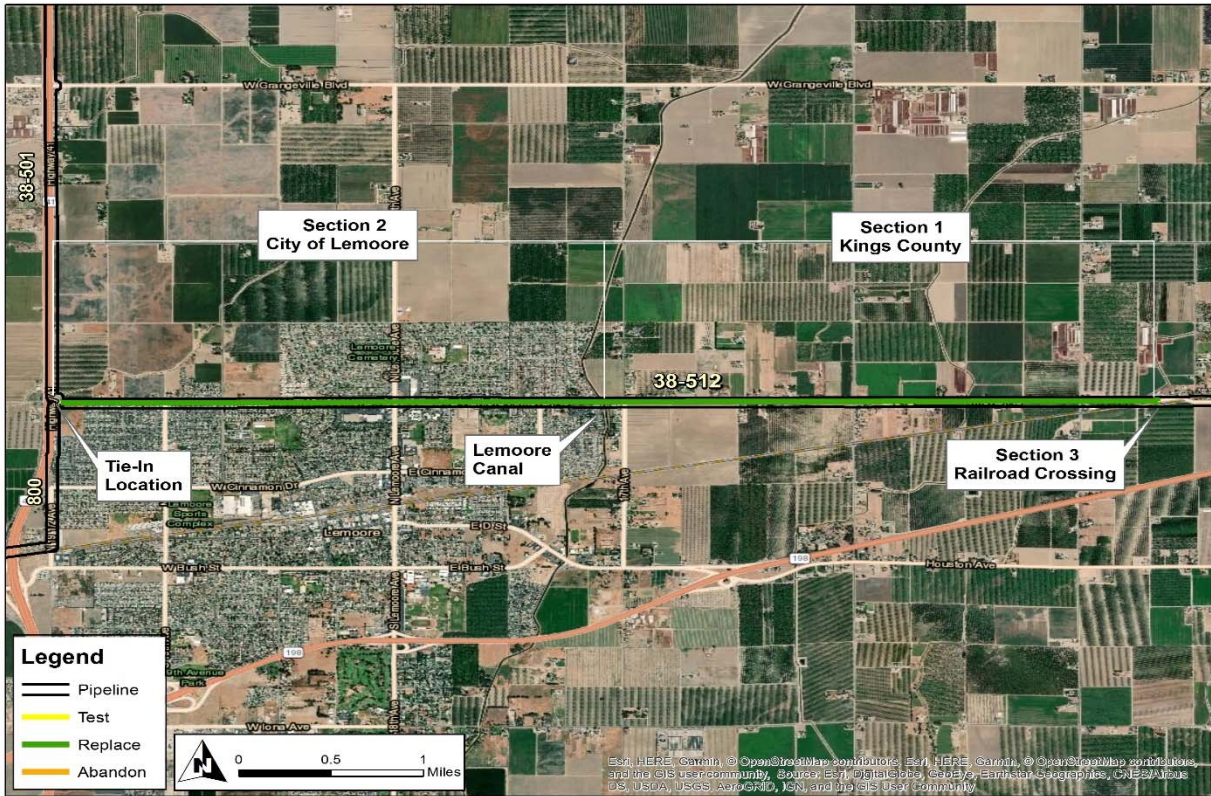

Pipeline Safety Enhancement Plan Final Report
Supply Line 38-512 Replacement Project

Figure 2: Overview Map of the Supply Line 38-512 Replacement Project

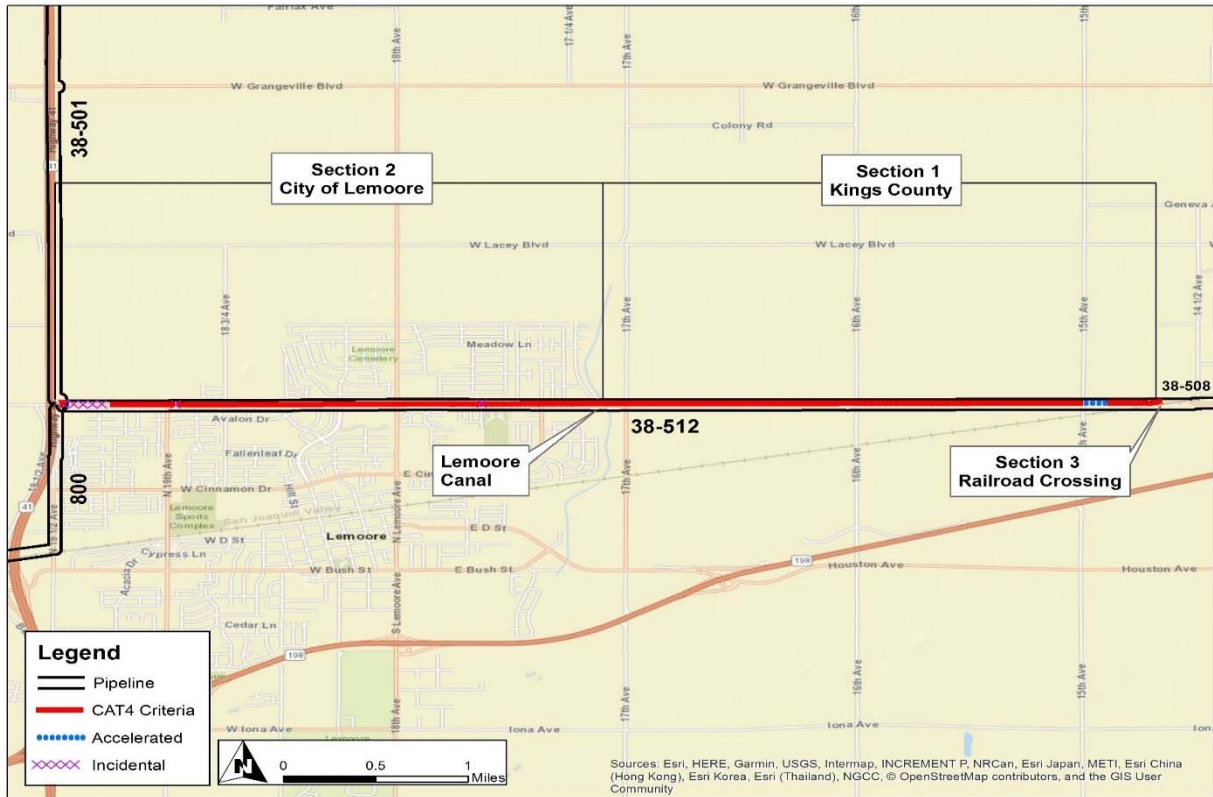

Pipeline Safety Enhancement Plan Final Report
 Supply Line 38-512 Replacement Project

Figure 3: Schematic of the Supply Line 38-512 Section 2 Replacement Project

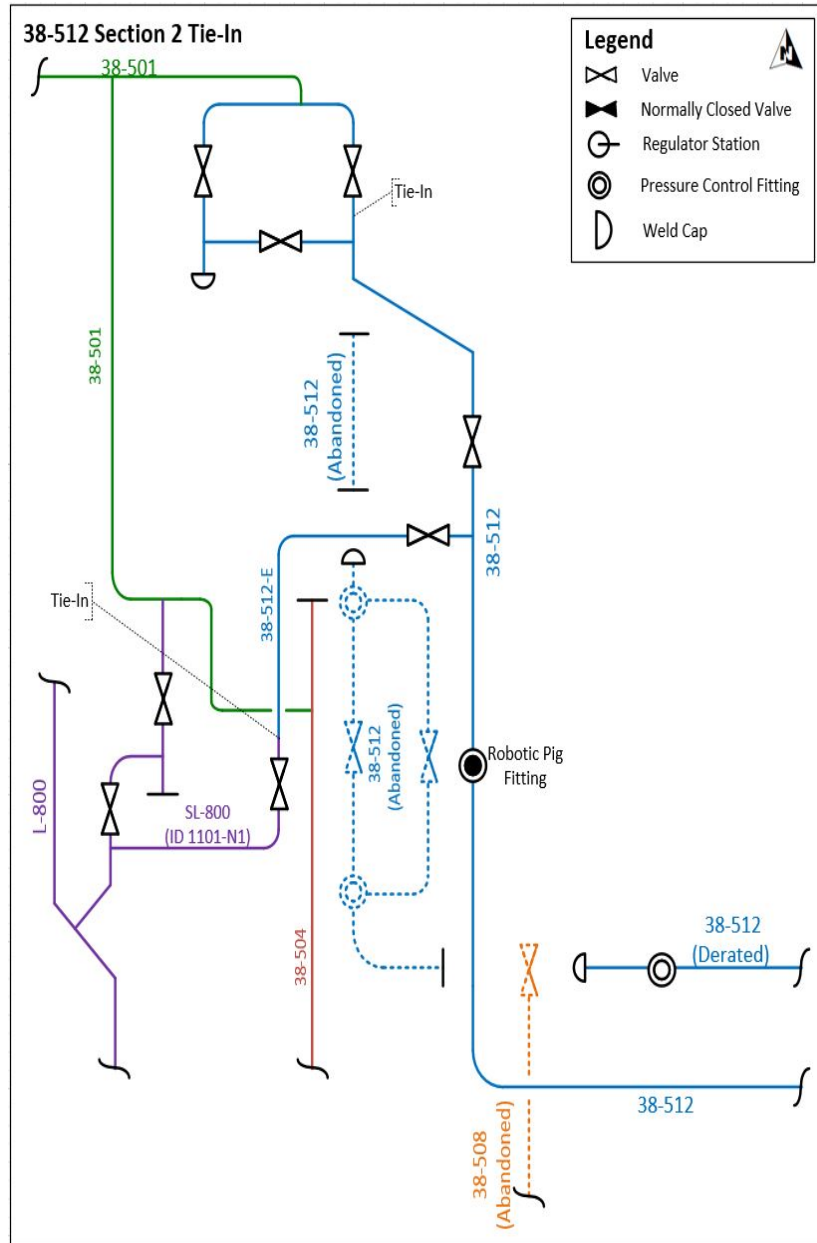

Pipeline Safety Enhancement Plan Final Report
Supply Line 38-512 Replacement Project

Figure 4: Schematic of the Supply Line 38-512 Section 3 Replacement Project

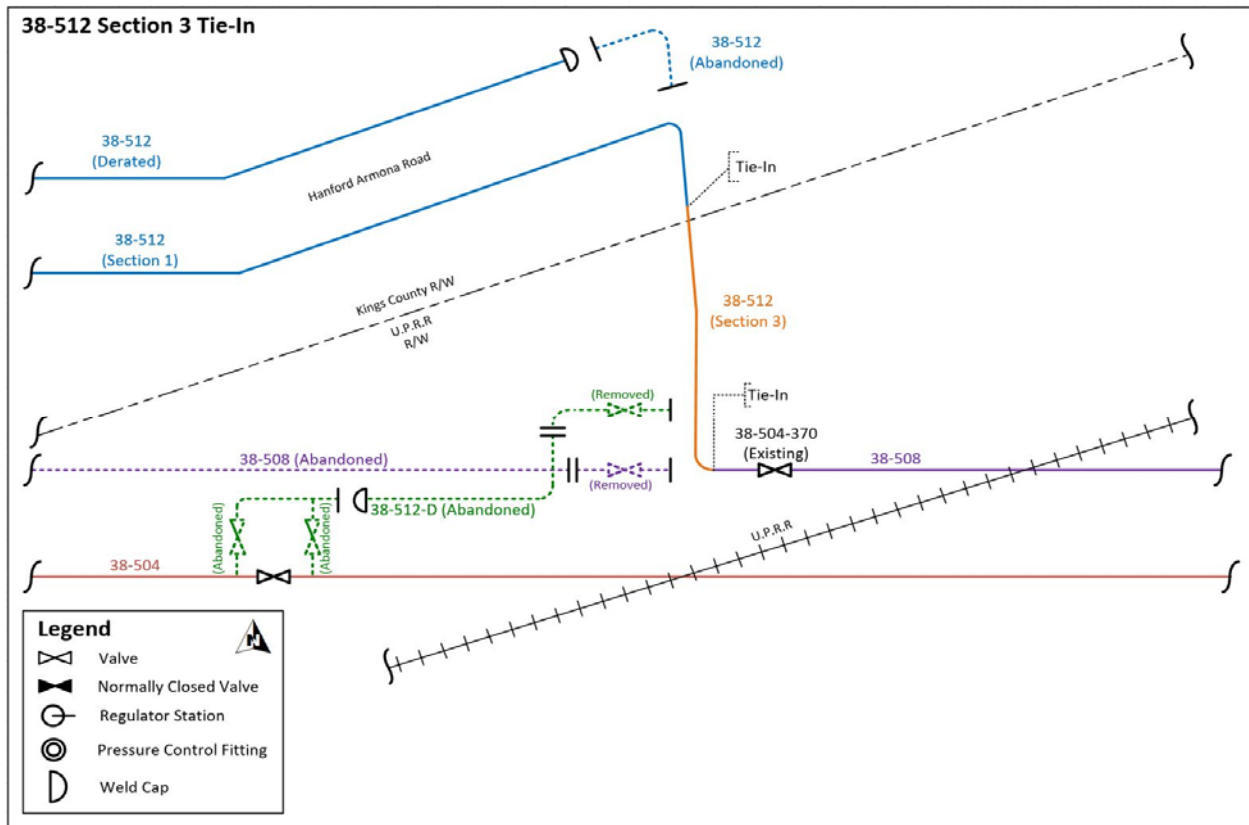

Pipeline Safety Enhancement Plan Final Report
Supply Line 38-512 Replacement Project

II. ENGINEERING, DESIGN, AND PLANNING

A. Project Scope

Table 2: Mileage Information

	Criteria	Accelerated ³	Incidental	New	Total ⁴
Final Mileage	4.322 mi.	0.322 mi.	0.248 mi.	0.068 mi.	4.960 mi.
	22,822 ft.	1,700 ft.	1,311 ft.	358 ft.	26,191 ft.

SoCalGas and SDG&E presented a conceptual project scope in workpapers supporting the 2011 PSEP filing⁵. Prior to initiating execution of the Project in 2015, SoCalGas and SDG&E reviewed existing pipeline records to validate the scope of the Project. During the Engineering, Design, and Planning phase, SoCalGas and SDG&E further refined the scope. This progression of the project scope is summarized as follows:

1. 2011 PSEP Filing: SoCalGas and SDG&E identified Supply Line 38-512 as a Phase 1A Replacement Project comprised of 2.238 miles of Category 4 Criteria pipe and 2.546 miles of Accelerated pipe.
2. Scope Validation: Through scope validation activities, after the 2011 filing and before initiating execution of the Project, SoCalGas and SDG&E increased the scope of the Project by 2.096 miles of Category 4 Criteria pipe.
3. Engineering, Design, and Constructability:
 - a. The Project Team initially planned and designed this project as a single project. The Project was subsequently split into two separate sections to schedule

³ Accelerated mileage includes Phase 1B and Phase 2A pipe. Phase 2A includes pipelines without sufficient record of a pressure test in less populated areas. The Accelerated mileage was included to realize efficiencies and to enhance project constructability.

⁴ Values may not add to total due to rounding.

⁵ See Amended PSEP of SoCalGas and SDG&E, submitted December 2, 2011, in R.11-02-019 and subsequently transferred to A.11-11-002.

Pipeline Safety Enhancement Plan Final Report
Supply Line 38-512 Replacement Project

construction activity around a roadway repaving moratorium in Kings County. Section 1, in Kings County, included approximately 2.46 miles of replacement pipe and Section 2, in the City of Lemoore, included approximately 2.46 miles of replacement pipe.

- b. Due to delays encountered during negotiations for a licensing agreement to a railroad property, the Project Team excluded a short 23-foot section, Section 3, out of Section 1 to complete construction and restore the site before the moratorium.
 - c. Two years after tie-in of Sections 1 and 2, the Project Team obtained the railroad license agreement and Section 3 was executed.
4. Final Project Scope: The final project scope consists of a 4.96-mile Replacement comprised of 0.320 miles of Accelerated Phase 1B pipe, 8 feet of Phase 2A pipe, 0.25 miles of Incidental pipe, and 358 feet of New pipe.

B. Decision Tree Analysis

SoCalGas and SDG&E performed a PSEP Decision Tree analysis of Supply Line 38-512 and confirmed the project design should commence as a Replacement Project.

Pipeline segments installed prior to 1946 that are not capable of being assessed using in-line inspection technology are identified for replacement under the approved PSEP Decision Tree. As explained in the testimony supporting the approved PSEP, as part of the work previously completed during implementation of federal gas transmission pipeline integrity management regulations (49 CFR 192, Subpart O), SoCalGas and SDG&E previously identified, retrofitted and in-line inspected pre-1946 transmission pipelines that were constructed using acceptable welding techniques and are operationally suited to in-line inspection. The remaining pre-1946 segments in the SoCalGas/SDG&E system are not suited for in-line inspection, likely have non-state-of-

Pipeline Safety Enhancement Plan Final Report
Supply Line 38-512 Replacement Project

the-art welds, and would require significant investment for retrofitting to accommodate in-line inspection tools. Accordingly, consistent with the Commission's directive in D.11-06-017 to "address retrofitting pipeline to allow for inline inspection tools," the requirement in California Public Utilities Code section 958 that upon completion of the PSEP, where warranted, pipelines are to be capable of accommodating in-line inspection devices, and the overarching objectives of PSEP to enhance the safety of the pipeline system in a proactive, cost effective manner, the approved PSEP Decision Tree identifies pre-1946 non-piggable pipeline segments for abandonment and/or replacement.

Through this Decision Tree analysis, SoCalGas and SDG&E identified replacement as the more prudent option. Key considerations that support SoCalGas and SDG&E's determination to replace this segment include:

1. Shut-In Analysis: The Project Team completed a Request for Engineering Review (RER) analysis and concluded that a shut-in would not significantly impact the transmission system that Supply Line 38-512 feeds.
2. Piggability: Non-piggable.
3. Existing Pipe Attributes: Unknown.
4. Pipe Vintage: 1929
5. Longseam Type: Unknown.
6. Longseam Repair History: No identified issues.
7. Condition of Coating: No identified issues.
8. History of Leaks: No identified issues.

Pipeline Safety Enhancement Plan Final Report
Supply Line 38-512 Replacement Project

C. Engineering, Design, and Planning Factors

SoCalGas and SDG&E reviewed pipeline drawings and other information, contacted internal planning groups, communicated with external stakeholders, conducted survey activities, including reviewing public records and potholing of the area to confirm the presence of underground utilities and substructures, and completed a pre-design site walk. Key factors that influenced the engineering and design of the Project are as follows:

1. Schedule Coordination:

- a. Kings County had a planned repaving project starting in June 2015, and prevented any non-emergency construction or disturbance to the new pavement. The Project Team determined that it would be necessary to complete construction prior to June 2015 to avoid interfering with the paving project by Kings County and the new roadway's moratorium. Interfering with the paving project and moratorium carried the risk of paying for the entire roadway to be repaved. The Project Team opted to schedule the replacement of Section 1 and Section 2, giving priority to the mileage in Kings County to prevent interference with the planned road moratorium.
- b. Due to significant delays encountered during negotiations for a license agreement to a railroad property, the Project Team found it necessary to isolate a short 27-foot section, Section 3, out of Section 1 in order to execute construction on the majority of the Project before the moratorium took effect.
- c. Execution of Section 3 was delayed for two years after construction was completed on Sections 1 and 2 because the railroad did not issue a license agreement before the tie-in of Section 1 and 2.

Pipeline Safety Enhancement Plan Final Report
Supply Line 38-512 Replacement Project

2. System Analysis: The Project Team replaced the existing [REDACTED] line with a [REDACTED] line based on the recommendation of the RER and to standardize the pipeline diameter to facilitate future pigability and take advantage of cost savings from favorable pricing of bulk-purchased pipe.
3. Customer Impacts: Service taps were not anticipated to experience service interruption, as SoCalGas and SDG&E would derate the existing pipeline to a medium pressure system upon completion of installation of the new pipeline.
4. Community Impacts: The Project Team planned for traffic control to mitigate construction impacts to businesses and residents along the proposed pipeline route (e.g., obstructed driveways).
5. Permit Conditions: SoCalGas and SDG&E were required to obtain permits from three permitting agencies for the Project—Kings County (Section 1 and Section 3), City of Lemoore (Section 2), and Caltrans (Section 2) for the west tie-in location near State Route 41.
6. Known Substructures: The Project Team identified multiple utility crossings within the proposed pipeline route anticipated to require the use of boring construction methods.
7. Constructability:
 - a. Railroad tracks within proximity of the tie-in location prompted safety concerns of project personnel and risked potential encroachment on the railroad right-of-way (ROW).
 - b. Multiple below-ground traffic light sensors/patches were identified within the construction route.

Pipeline Safety Enhancement Plan Final Report
Supply Line 38-512 Replacement Project

8. Environmental: This Project was eligible for incidental take coverage under the San Joaquin programmatic permit for fish and wildlife. Air quality management would require contact prior to the removal of any coal tar pipe wrap.

D. Scope Changes

Through engineering, design, and planning activities, SoCalGas and SDG&E determined that changes in scope were appropriate to enhance the design of the Project and address engineering factors. As a result, the preliminary cost estimate does not fully reflect the final scope. Summarized below is the notable change in scope made after the preliminary cost estimate was developed and approved.

1. Permit Conditions: The project design was split into two separate construction sections to accelerate work in Kings County (Section 1) to avoid potential conflict with a planned repaving project and moratorium by Kings County. This accelerated work would be completed by the beginning of June 2015 to prevent any interference with the planned repaving project. This accelerated work would also avoid costs of repaving the new road.
2. Land Rights: Due to delays encountered while negotiating for a licensing agreement to a railroad property, the Project Team sectionalized Section 3 during construction of Section 1 and 2.

Pipeline Safety Enhancement Plan Final Report
Supply Line 38-512 Replacement Project

III. CONSTRUCTION

A. Construction Contractor Selection

The Project Team prepared an initial cost estimate based on the preliminary design for Sections 1, 2, and 3. Following completion of the engineering, design, and planning activities described above, the Project Team directed the Performance Partner to prepare cost estimates based on a more detailed engineering design package for Sections 1 and 2, that included the updated design as described in the Scope Changes discussion above and Section 3 be executed on a time and material basis. SoCalGas and SDG&E awarded the construction contract to the Performance Partner.

1. SoCalGas and SDG&E’s Preliminary Construction Cost Estimate (confidential):
SoCalGas and SDG&E’s preliminary cost estimate for construction of Sections 1, 2, and 3 was [REDACTED].
2. Construction Contractor’s Target Price Estimate (confidential): The Construction Contractor’s cost estimates for Sections 1, 2, and 3 was [REDACTED], which was [REDACTED] than SoCalGas and SDG&E’s preliminary cost estimate for construction.

B. Construction Schedule

Table 3: Construction Timeline

Section 1 and 2	
Construction Start	03/16/2015
Construction Completion	12/01/2015
NOP Date	10/20/2015
Section 3	
Construction Start	09/18/2017
Construction Completion	10/13/2017
NOP Date	10/03/2017

Pipeline Safety Enhancement Plan Final Report
Supply Line 38-512 Replacement Project

C. Changes During Construction

The conditions summarized below were encountered during construction. Activities to address or mitigate these conditions resulted in approximately \$2,630,000 in change orders for Section 1 and 2. For Section 3, SoCalGas and SDG&E successfully mitigated conditions during construction in a manner that minimized potential impacts on project scope, cost, and schedule. As a result, these conditions did not result in any notable change orders.

Section 1 (Kings County Replacement)

1. Access:

- a. Union Pacific Railroad (UPRR) rejected a proposed ROW crossing in the planned design, resulting in a redesign of the planned pipeline to reroute parallel to the Kings County ROW, requiring an additional open trench pipe installation.

The planned design was a diagonal crossing of the ROW to parallel existing pipeline alignments; however, UPRR asked for the crossing to have the least encroachment on its ROW, which necessitated a perpendicular crossing of the ROW.

- b. The Construction Contractor observed at the construction kickoff meeting that the main laydown and pipe yard was not in usable condition (graded and leveled) and would require additional preparation because the property owner had used a disc plow to clear brush from the site. There was also a trench that had been cut, blocking the entrance for the trucks.
2. Site Conditions: Throughout the planned Project route, the Construction Contractor encountered sandy soil (sugar sand) resulting in a ditch cave-in during excavation and lower-in of shoring. To avert these conditions, the Project Team mobilized an

Pipeline Safety Enhancement Plan Final Report
Supply Line 38-512 Replacement Project

additional crew and shoring equipment to help ensure the Project would be completed before the June 2015 deadline set forth by Kings County.

3. Traffic: Due to concerns for the safety of project personnel and the public, the Project Team added pilot cars to shepherd the public through lane closures. This was in response to the public not obeying traffic signage and flagging personnel around lane closures.
4. Weather: The Project experienced two occurrences of standby due to weather, which included lightning and heavy rain that resulted in flooding at the laydown yard, and led the Project to incur standby charges.
5. Substructures: Additional potholing and traffic control was required to identify the location of multiple unidentified foreign line crossings.
6. Environmental Abatement: Additional hand digging and vacuuming was required to excavate around potentially contaminated soil from asbestos contaminated pipe coating.
7. Other: In preparation for the execution of Section 2 and before the completion of Section 1, the Construction Contractor unloaded and stockpiled pipe and parts.

Section 2 (City of Lemoore Replacement)

1. Substructures:
 - a. The Construction Contractor encountered subsurface asphalt below the assumed thickness, which required additional equipment to remove the asphalt and sift the soil for disposal.
 - b. Due to the presence of multiple unmarked water line crossings in locations with sugar sand, the Project Team determined that additional bores should be added

Pipeline Safety Enhancement Plan Final Report
Supply Line 38-512 Replacement Project

- to advent constructability challenges and reduce costs of open trenching in sugar sand.
- c. Additional slot trenching and traffic control was required when the Construction Contractor encountered unidentified foreign line crossings, subsurface debris, and a large concrete vault in the planned pipeline route near Lemoore Junction that were not identified on city or county maps for the Project.
 - d. Additional potholing and traffic control was required, as the Construction Contractor encountered multiple unidentified line crossings in the path of the Project.
 - e. The Construction Contractor struck an unmarked waterline in the excavated trench, requiring the cleanup of water and mud from the trench and surrounding street. To reopen the intersection, the Construction Contractor backfilled and re-excavated the ditch.
 - f. Due to a conflict with a transite water line and a subsurface concrete vault, the Construction Contractor installed approximately 897 feet of pipe using horizontal directional drilling (HDD).
 - g. Additional potholing, along with backfilling and re-excavation of intended bore pits, was required when the Construction Contractor encountered two fiber optic lines in conflict with the planned pipeline route, requiring the route to be altered. These items were not identified on city or county maps for the Project.
2. Schedule Delay: Multiple construction delays due to sugar sand, unknown substructures, and weather pushed the project schedule into a gas handling conflict with the adjacent Supply Line 44-687 Project, requiring additional time to complete the work. The initial project schedule did not plan for an overlap of the gas handling schedule due to the system not being capable of having both lines shut-in at the

Pipeline Safety Enhancement Plan Final Report
Supply Line 38-512 Replacement Project

same time. Delays were also experienced when this project was completing the tie-in, due to the presence of an unknown vault in the excavation area at the west tie-in (Lemoore Junction). As a result, the tie-in required three separate welds, as opposed to the typical two welds, and was further complicated due to an existing valve located at one of the tie-ins and welds being at a misoriented angle requiring additional fabrication to complete the tie-in.

3. Site Conditions: Throughout the Project, the Construction Contractor encountered sugar sand resulting in ditch cave-in during excavation and lower-in of shoring. The challenges faced due to sugar sand and the work to resolve these issues varied by location. To mitigate these conditions, the Construction Contractor soaked the soil for cohesion to prevent cave-ins, backfilled problematic sections with slurry, and used additional shoring.
4. Traffic: Due to concerns for the safety of project personnel and the public, the Project Team added pilot cars to shepherd the public through lane closures. This was in response to the public not obeying traffic signage and flagging personnel around lane closures.
5. Field Design Changes: The Project Team relocated the planned electrolysis test station locations to the north shoulder of Hanford Aroma Road, instead of the roadway, to increase work safety for operating personnel in the future. This activity required asphalt and concrete demolition and hydro excavating a lateral trench at each of the two stations.
6. Weather: The Project experienced multiple occurrences of standby due to weather, which included lightning on 07/10/2015 and 10/15/2015, dense fog on 10/16/2015, and rain on 11/02/2015.

Pipeline Safety Enhancement Plan Final Report
Supply Line 38-512 Replacement Project

7. Equipment Needs: To efficiently complete post construction redlining and documentation closeout, the Construction Contractor maintained an office trailer past the demobilization date of the other project equipment and sites.

Section 3 (Railroad ROW Replacement)

SoCalGas and SDG&E successfully mitigated conditions during construction in a manner that minimized potential impacts on project scope, cost, and schedule. As a result, these conditions did not result in any notable change orders.

Figure 5: Section 2 - Broken Waterline



Pipeline Safety Enhancement Plan Final Report
Supply Line 38-512 Replacement Project

Figure 6: Section 2 - Broken Waterline Clean Up



Pipeline Safety Enhancement Plan Final Report
Supply Line 38-512 Replacement Project

Figure 7: Section 2 - Bore Pit



Pipeline Safety Enhancement Plan Final Report
Supply Line 38-512 Replacement Project

Figure 8: Section 2 – Checking Integrity of Coating



Pipeline Safety Enhancement Plan Final Report
Supply Line 38-512 Replacement Project

Figure 9: Section 2 - Lowering Fabricated Section of Pipe into Trench with Sugar Sand



Pipeline Safety Enhancement Plan Final Report
Supply Line 38-512 Replacement Project

D. Commissioning and Site Restoration

Commissioning activities include restoration of the site, final inspection and placement of the pipeline back into service, transportation and disposal of hydrotested water and hazardous material, and site demobilization.

Closeout activities include development of final as-built drawings, finalization of a reconciliation package, and updates to company recordkeeping systems to reflect the completed scope of work.

Pipeline Safety Enhancement Plan Final Report
Supply Line 38-512 Replacement Project

IV. PROJECT COSTS

A. Cost Avoidance Actions

SoCalGas and SDG&E exercised due diligence in the planning, design, and construction activities for this Project to minimize or avoid costs when prudent to do so. As discussed above, the Project Team conducted a site visit to identify and incorporate discernible site conditions into the engineering, design, and planning of the Project. Specific examples of cost avoidance actions taken on this project are:

1. Engineering and Design: The Project Team reduced a portion of the existing pipeline to medium pressure to avoid installation of customer service taps on the new transmission pipeline and to reduce cost to temporarily provide service to customers when transferring taps from the old line to the new line. The Project Team abandoned in place the remaining portions of the existing pipeline that did not have a reduction to medium pressure.
2. Planning and Coordination:
 - a. Kings County scheduled a repaving project starting in June 2015 and constrained any third party from performing construction in the newly-paved area for the first five years. PSEP opted to replace Supply Line 38-512 in two continuous construction phases, giving priority to the mileage in Kings County (Section 1) to avoid repaving costs.
 - b. Section 2 in the City of Lemoore was accelerated to avoid demobilization costs following the completion of the Section 1 construction in Kings County.
3. Construction Execution:
 - a. The Project Team utilized pipe roping over installation of bends.

Pipeline Safety Enhancement Plan Final Report
Supply Line 38-512 Replacement Project

- b. The Project Team reduced the depth of cover from 52 inches to 42 inches to remediate sugar sand conditions. This avoided additional soil sifting and disposal, along with increasing the trenching production.
4. Materials: Bulk ordering enabled SoCalGas and SDG&E to obtain favorable volume pricing for the [REDACTED] pipe.
5. Water Management: The Project Team reused water from the hydrotest for dust control.
6. Permit Conditions: The Project Team obtained county approval to work ten-hour days, six days per week to meet the county's imposed hard stop for the street repaving project.

B. Cost Estimate

Based on the preliminary design, once the project scope was confirmed and engineering, design, and planning activities were underway, SoCalGas and SDG&E prepared an estimate of the Direct Costs of the Project in the amount of \$22,538,313. This estimate was prepared in January of 2015, using the "SCG Pipeline Estimate Template Rev 1"⁶ estimating tool, the most current version of the PSEP Estimate Template at the time. The Project Team considered the conditions known at the time to prepare the preliminary Direct Cost estimate. This estimate reflects the projected Labor, Material and Services costs anticipated to be incurred to execute the Project.

SoCalGas and SDG&E estimated Indirect Costs of the Project based on the estimated Direct Costs and other project-related variables.

⁶ The estimate for Section 3 was prepared using the Rev 4 version of the estimating tool created in June of 2017

Pipeline Safety Enhancement Plan Final Report
Supply Line 38-512 Replacement Project

C. Actual Direct and Indirect Costs

Actual Direct Costs reflect the Labor, Material, and Service costs incurred to execute the Project. Actual Indirect Costs reflect costs for incremental overhead loaders in accordance with Company overhead allocation policies. The total loaded costs to complete the Project is \$32,133,994.

Table 4: Estimated and Actual Direct Costs and Variances

Direct Costs (\$)	Estimate	Actuals	Delta Over/(Under)
Company Labor	834,342	653,266	(181,076)
Materials	1,551,316	841,943	(709,373)
Construction Contractor	14,467,808	16,720,798	2,252,990
Construction Management & Support	1,641,639	3,100,782	1,459,143
Environmental	485,218	601,065	115,847
Engineering & Design	1,396,421	2,770,087	1,373,666
Project Management & Services	1,767,560	653,330	(1,114,230)
ROW & Permits	44,397	282,840	238,443
GMA	349,612	3,331,080	2,981,468
Total Direct Costs	22,538,313	28,955,191	6,416,878

Table 5: Estimated and Actual Indirect Costs, Total Costs, and Variances

Indirect Costs/Total Costs (\$)	Estimate	Actuals	Delta Over/(Under)
Overheads	1,972,823	2,336,136	363,313
AFUDC	865,068	747,260	(117,808)
Property Taxes	183,638	95,407	(88,231)
Total Indirect Costs	3,021,529	3,178,803	157,274
Total Direct Costs	22,538,313	28,955,191	6,416,878
Total Loaded Costs	25,559,842	32,133,994	6,574,152

Pipeline Safety Enhancement Plan Final Report
Supply Line 38-512 Replacement Project

D. Disallowance

There is no disallowance calculation for the Supply Line 38-512 Project, as there were no post-1955 segments included in the Project without records that provide the minimum information to demonstrate compliance with then applicable industry standards or regulatory strength testing and recordkeeping requirements.

Pipeline Safety Enhancement Plan Final Report
Supply Line 38-512 Replacement Project

V. CONCLUSION

SoCalGas and SDG&E enhanced the safety of their integrated natural gas transmission system by prudently executing the Supply Line 38-512 Replacement Project. Through this Replacement Project, SoCalGas and SDG&E successfully replaced 4.96 miles of pipe in the City of Lemoore and Kings County. The total loaded cost of the Project is \$32,133,994.

SoCalGas and SDG&E executed this Project prudently through engaging in scope validation efforts that identified additional project mileage and responding to numerous unanticipated field conditions, including unknown substructures, sandy soil conditions, and weather.

SoCalGas and SDG&E engaged in prudent cost avoidance efforts by coordinating with Kings County to avoid a paving moratorium, participating in the bulk order purchase of [REDACTED] pipe, reusing water from the hydrotest for dust control, utilizing pipe roping construction methods over the installation of bends, and avoiding installation of customer service taps on the new transmission pipeline by derating a portion of the existing pipeline to medium pressure.

End of Supply Line 38-512 Replacement Project Final Report

Pipeline Safety Enhancement Plan Final Report
Supply Line 38-514 Replacement Project

I. SUPPLY LINE 38-514 SECTION 1 AND 2 REPLACEMENT PROJECT

A. Background and Summary

Supply Line 38-514 is a [REDACTED] diameter transmission line that runs approximately 15 miles through farmland from the unincorporated community of Hub to the unincorporated community of Burrel in Fresno County. The pipeline is primarily routed across Class 1 and 2 locations and traverses some Class 3 locations. This report describes the activities associated with the Supply Line 38-514 Replacement Project that consists of the replacement of 2.930 miles of pipeline and replacement of one mainline valve (MLV). The specific attributes of this Project are detailed in Table 1 below. The total loaded cost of the Project is \$14,774,343.

Table 1: General Project Information

Project Name	Supply Line 38-514		
Project Type	Replacement		
Length	2.930 miles		
Location	City of Hub, City of Riverdale, and Fresno County		
Class	3		
MAOP (<i>confidential</i>)	[REDACTED]		
Pipe Vintage	1945		
Construction Start	02/16/2016		
Construction Finish	06/30/2016		
Original Pipe Diameter (<i>confidential</i>)	[REDACTED]		
New Diameter (<i>confidential</i>)	[REDACTED]		
Original SMYS ¹ (<i>confidential</i>)	[REDACTED]		
New SMYS (<i>confidential</i>)	[REDACTED]		
Project Costs (\$)	Capital	O&M	Total
Loaded Project Costs	14,751,198	23,145	14,774,343
Disallowed Costs	-	-	-

¹ Highest percentage of Specified Minimum Yield Strength (SMYS) of Category 4 Criteria pipe.

Pipeline Safety Enhancement Plan Final Report
Supply Line 38-514 Replacement Project

B. Maps and Images

Figure 1: Satellite Image of Supply Line 38-514 Replacement Projects

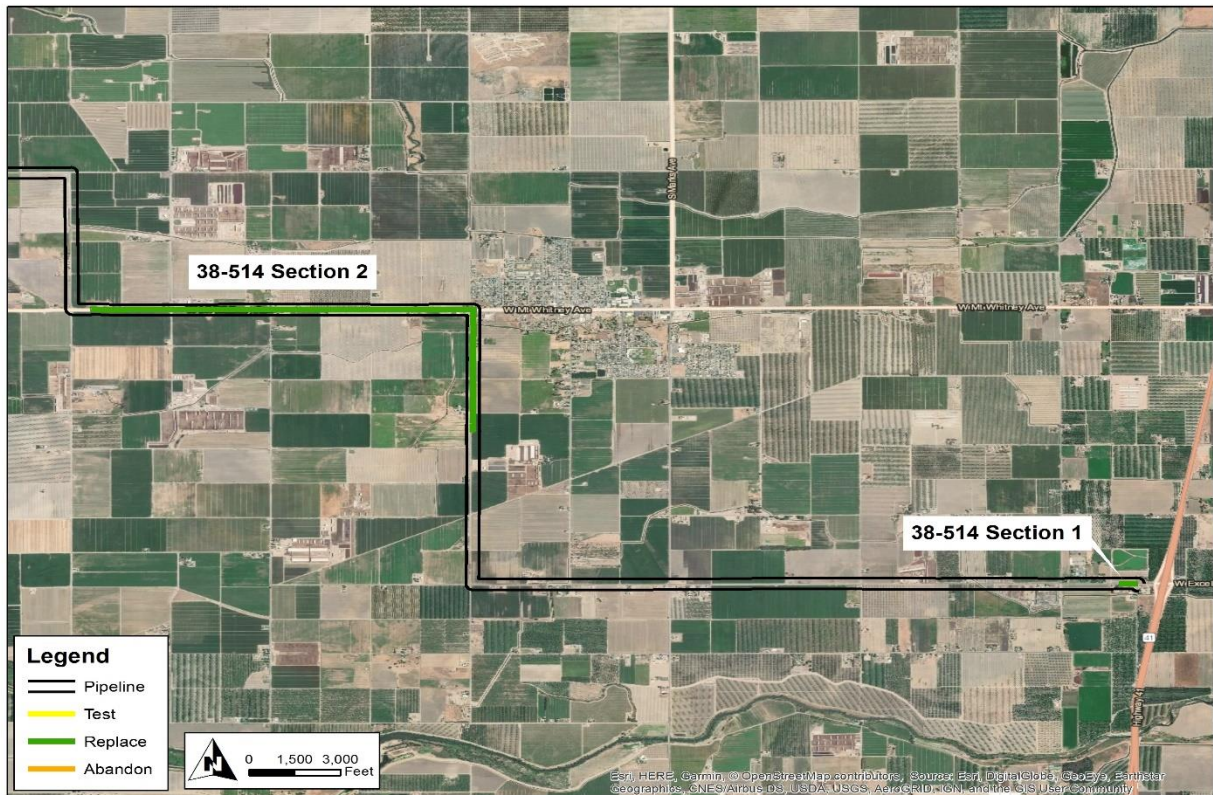

Pipeline Safety Enhancement Plan Final Report
Supply Line 38-514 Replacement Project

Figure 2: Satellite Image of Supply Line 38-514 Section 1 Replacement Project



Pipeline Safety Enhancement Plan Final Report
Supply Line 38-514 Replacement Project

Figure 3: Overview Map of Supply Line 38-514 Section 1 Replacement Project

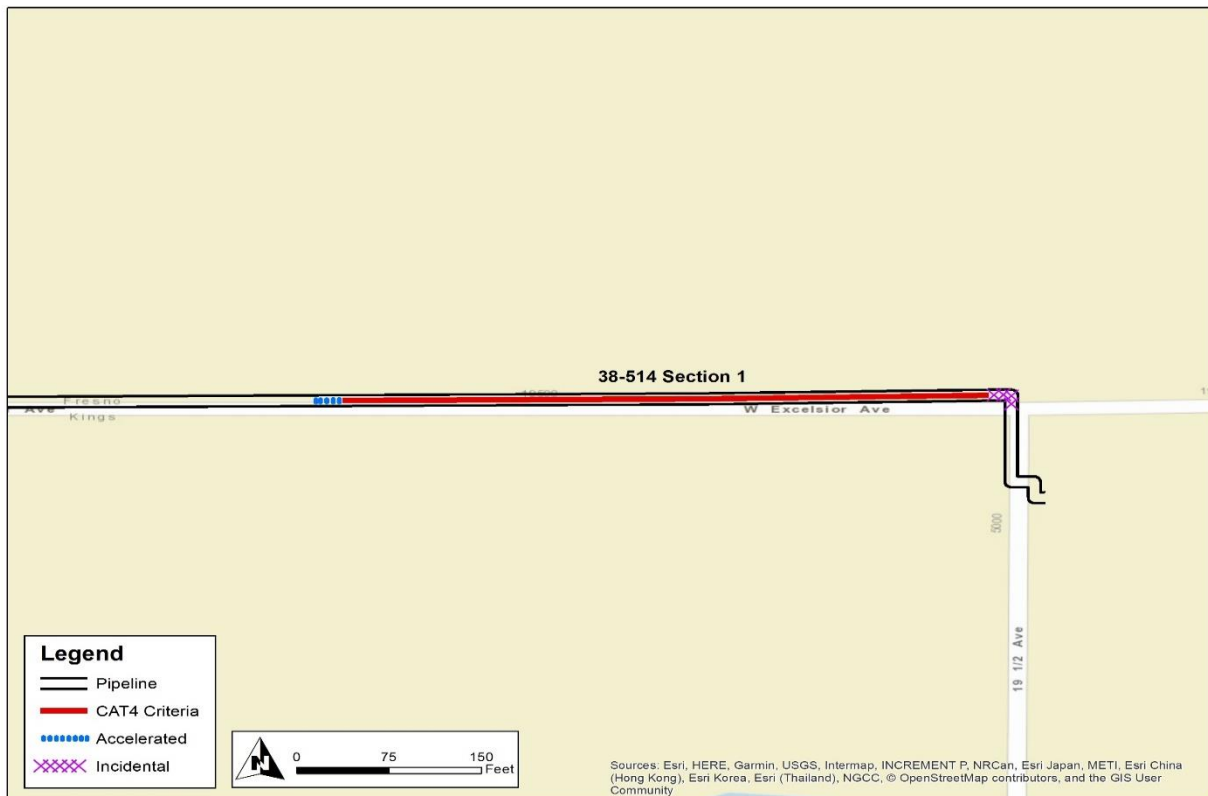

Pipeline Safety Enhancement Plan Final Report Supply Line 38-514 Replacement Project

Figure 5: Overview Map of Supply Line 38-514 Section 2 Replacement Project



Pipeline Safety Enhancement Plan Final Report
Supply Line 38-514 Replacement Project

II. ENGINEERING, DESIGN, AND PLANNING

A. Project Scope

Table 2: Mileage Information

	Criteria	Accelerated ²	Incidental	New	Total ³
Final Mileage	1.406 mi.	1.489 mi.	0.026 mi.	0.009 mi.	2.930 mi.
	7,422 ft.	7,862 ft.	141 ft.	47 ft.	15,472 ft.

SoCalGas and SDG&E presented a conceptual project scope in workpapers supporting the 2011 PSEP filing.⁴ Prior to initiating execution of the Project in 2016, SoCalGas and SDG&E reviewed existing pipeline records to validate the scope of the Project. During the Engineering, Design, and Planning phase, SoCalGas and SDG&E further refined the scope. The progression of project scope is summarized as follows:

1. 2011 PSEP Filing: SoCalGas and SDG&E identified Supply Line 38-514 as a Phase 1A Replacement Project comprised of 0.174 miles Category 4 Criteria pipe and 4.098 miles of Accelerated pipe.
2. Scope Validation: Through scope validation activities, after the 2011 filing and before initiating execution of the Project, SoCalGas and SDG&E increased the scope of the Project by 1.232 miles of Category 4 Criteria pipe.

² Accelerated mileage includes Phase 1B pipe. The Accelerated mileage was included to realize efficiencies and to enhance project constructability.

³ Values may not add to total due to rounding.

⁴ See Amended PSEP of SoCalGas and SDG&E, submitted December 2, 2011, in R.11-02-019 and subsequently transferred to A.11-11-002.

Pipeline Safety Enhancement Plan Final Report
Supply Line 38-514 Replacement Project

3. Engineering, Design, and Constructability:

- a. Based on the non-contiguous location of the Category 4 Criteria pipe, the Project Team planned the execution of the Supply Line 38-514 Replacement Project in two sections.
- b. Based on the class location differences along Excelsior Avenue, Section 1 was further split creating a new project section, Section 3. Section 1 consists of 0.081 miles of Category 4 Criteria pipe. The remaining portion, Section 3⁵, consists of 1.382 miles of Phase 1B pipe located between Section 1 and Section 2 that will be completed in the future.
- c. Section 2 consists of 1.325 miles of Category 4 Criteria pipe and 1.486 miles of Accelerated Phase 1B pipe.
- d. The Project Team included Accelerated pipe for Section 2 due to similar permitting and design requirements and included Incidental pipe for tie-in locations extending beyond the limits of the Accelerated pipe.

4. Final Project Scope: The final project scope consists of a 2.930 mile Replacement. The Accelerated mileage consists of 1.489 miles of Phase 1B pipe and 141 feet of Incidental pipe.

B. Decision Tree Analysis

SoCalGas and SDG&E performed a PSEP Decision Tree analysis of Supply Line 38-514 and confirmed the project design should commence as a Replacement Project.

⁵ Line 38-514 Section 3 is a Phase 1B project and was included in A.17-03-021 2017 PSEP Forecast Application.

Pipeline Safety Enhancement Plan Final Report
Supply Line 38-514 Replacement Project

Pipeline segments installed prior to 1946 that are not capable of being assessed using in-line inspection technology are identified for replacement under the approved PSEP Decision Tree. As explained in the testimony supporting the approved PSEP, as part of the work previously completed during implementation federal gas transmission pipeline integrity management regulations (49 CFR 192, Subpart O), SoCalGas and SDG&E have already identified, retrofitted and in-line inspected pre-1946 transmission pipelines that were constructed using acceptable welding techniques and are operationally suited to in-line inspection. The remaining pre-1946 segments in the SoCalGas/SDG&E system are not suited for in-line inspection, likely have non-state-of-the-art welds, and would require significant investment for retrofitting to accommodate in-line inspection tools. Accordingly, consistent with the Commission’s directive in D.11-06-017 to “address retrofitting pipeline to allow for inline inspection tools,” the requirement in California Public Utilities Code section 958 that upon completion of the PSEP, where warranted, pipelines are to be capable of accommodating in-line inspection devices, and the overarching objectives of PSEP to enhance the safety of the pipeline system in a proactive, cost effective manner, the approved PSEP Decision Tree identifies pre-1946 non-piggable pipeline segments for abandonment and/or replacement.

Through Decision Tree analysis, SoCalGas and SDG&E identified replacement as the more prudent option. Key considerations that support SoCalGas and SDG&E’s determination to replace this segment include:

1. Shut-In Analysis: The Project Team completed a Request for Engineering Review (RER) analysis and concluded that the pipeline could be shut-in during tie-in if compressed natural gas (CNG) is used to maintain service to one regulator station.
2. Customer Impacts: The Project Team would need to maintain feed to one regulator station during tie-in.

Pipeline Safety Enhancement Plan Final Report
Supply Line 38-514 Replacement Project

3. Community Impacts: No identified issues.
4. Permit Conditions: No identified issues.
5. Piggability: Non-piggable.
6. Pipe Vintage: 1945.
7. Existing Pipe Attributes: No identified issues.
8. Longseam Type: Unknown.
9. Longseam Repair History: No identified issues.
10. Condition of Coating: No identified issues.
11. History of Leaks: No identified issues.

C. Engineering, Design, and Planning Factors

SoCalGas and SDG&E reviewed pipeline drawings and other information, contacted internal planning groups, communicated with external stakeholders, conducted survey activities, including reviewing public records and potholing of the area to confirm the presence of underground utilities and substructures, and completed a pre-design site walk. Key factors that influenced the engineering and design of the Project are as follows:

Section 1 and Section 2

1. Diameter Changes: The Project Team replaced the existing [REDACTED] line with a [REDACTED] line based on the recommendation from the RER and the Operating District. The additional cost to upsize the supply line was funded by the Operating District as discussed below in Actual Direct and Indirect Costs.

Pipeline Safety Enhancement Plan Final Report
Supply Line 38-514 Replacement Project

2. Land Use: The Project Team planned on extending the lease on the laydown yard to be available for construction of Supply Line 38-514 Section 1 Replacement Project, that was scheduled for construction immediately following the completion of Section 2.

Section 1

1. Customer Impacts: The Project Team planned tie-ins utilizing pressure control fittings (PCFs) to maintain customer feed.
2. Valves: The Project Team designed a new [REDACTED] MLV at the west tie-in point for future isolation capabilities on Supply Line 38-514.

Section 2

3. Customer Impacts: The Project Team planned tie-ins utilizing PCFs at the mainline tie-ins and at the regulator station to maintain customer feed during construction and CNG bottles as needed during customer tap tie-ins.
4. Valves: The Project Team designed a new [REDACTED] ball valve at the east tie-in to replace the existing [REDACTED] MLV.

D. Scope Changes

SoCalGas and SDG&E did not make any notable scope changes during detailed design.

Pipeline Safety Enhancement Plan Final Report
Supply Line 38-514 Replacement Project

III. CONSTRUCTION

A. Construction Contractor Selection

The Project Team prepared an initial cost estimate based on the preliminary design. Following completion of the engineering, design, and planning activities described above, the Project Team directed the Performance Partner to prepare cost estimates based on a more detailed engineering design package. As indicated above, there were no notable changes in scope between the time when the Project Team prepared the preliminary cost estimate and when the Performance Partner prepared and submitted its Target Price Estimate. SoCalGas and SDG&E awarded the construction contract to the Performance Partner.

1. SoCalGas and SDG&E’s Preliminary Construction Cost Estimate (confidential):

SoCalGas and SDG&E’s preliminary cost estimate for construction was [REDACTED].

2. Construction Contractor’s Target Price Estimate (confidential): The Construction

Contractor’s cost estimate was [REDACTED], which was [REDACTED] than SoCalGas and SDG&E’s preliminary cost estimate for construction.

B. Construction Schedule

Table 3: Construction Timeline

Construction Start Date	02/16/2016
Construction Completion Date	06/30/2016
NOP Date	06/17/2016

Pipeline Safety Enhancement Plan Final Report
Supply Line 38-514 Replacement Project

C. Changes During Construction

The conditions summarized below were encountered during construction. Activities to address or mitigate these conditions resulted in approximately \$460,000 in change orders.

1. Constructability Issues: The Operating District performed the tapping procedures for the PCFs. During this activity, the tapping machine failed resulting in the need to relocate and install a new PCF. The Construction Contractor aided in the efforts to excavate and install the new PCF.
2. Soil Conditions: The Construction Contractor encountered sandy soil (sugar sand) during construction for both replacement sections reducing the Construction Contractor's productivity in stabilizing the sugar sand.
3. Site Conditions: The Construction Contractor temporarily graded the shoulder of the road to ensure public safety during construction. The Construction Contractor restored the road shoulder after construction.

D. Commissioning and Site Restoration

Commissioning activities include restoration of the site, final inspection and placement of the pipeline back into service, transportation, and disposal of hydrotested water and hazardous material, and site demobilization. Closeout activities include development of final drawings, finalization of a reconciliation package, and updates to company recordkeeping systems to reflect the completed scope of work.

Pipeline Safety Enhancement Plan Final Report
Supply Line 38-514 Replacement Project

IV. PROJECT COSTS

A. Cost Avoidance Actions

SoCalGas and SDG&E exercised due diligence in the planning, design, and construction activities for this project to minimize or avoid costs when prudent to do so. As discussed above, the Project Team conducted a site visit to identify and incorporate discernible site conditions into the engineering, design, and planning of the Project. Specific examples of cost avoidance actions taken on this project are:

1. Engineering and Design: The Construction Contractor roped the pipeline at utility crossings where possible, reducing the cost for elbows and additional welding.
2. Planning and Coordination: The Construction Contractor worked on Supply Line 38-514 Section 1 Replacement Project during delays on Supply Line 38-514 Section 2 Replacement Project, avoiding potential standby charges.

B. Cost Estimate

Based on the preliminary design, once the project scope was confirmed and engineering, design, and planning activities were underway, SoCalGas and SDG&E prepared an estimate of the Direct Costs of the Project in the amount of \$22,174,864. The Section 1 estimate was prepared in May of 2016 and the Section 2 estimate was prepared in October of 2015, both sections using the “SCG Pipeline Estimate Template Rev 3” estimating tool, the most current version of the PSEP Estimate Template at the time. The Project Team considered the conditions known at the time to prepare the preliminary Direct Cost estimate.

Pipeline Safety Enhancement Plan Final Report
Supply Line 38-514 Replacement Project

This estimate reflects the projected Labor, Material, and Services costs anticipated to be incurred to execute the Project.

SoCalGas and SDG&E estimated Indirect Costs of the Project based on the estimated Direct Costs and other project-related variables.

C. Actual Direct and Indirect Costs

Actual Direct Costs reflect the Labor, Material, and Service costs incurred to execute the Project. Actual Indirect Costs reflect costs for incremental overhead loaders in accordance with Company overhead allocation policies. The total loaded cost of the Project is \$14,774,343.

The total Direct and Indirect costs for this project include a credit provided by the Operating District to fund the cost difference associated with the change in pipeline diameter. The Project Team completed a comparative cost estimate during the preliminary design cost estimate of the two diameters to calculate the incremental cost difference associated with the change in pipeline diameter.

Pipeline Safety Enhancement Plan Final Report
Supply Line 38-514 Replacement Project

Table 4: Estimated and Actual Direct Costs and Variances

Direct Costs (\$)	Estimate	Actuals ⁶	Delta Over/(Under)
Company Labor	759,375	493,167	(266,208)
Materials	1,768,765	297,825	(1,470,940)
Construction Contractor	13,138,630	7,598,855	(5,539,775)
Construction Management & Support	1,146,282	771,264	(375,018)
Environmental	403,995	380,277	(23,718)
Engineering & Design	1,806,255	1,917,393	111,138
Project Management & Services	937,041	300,225	(636,816)
ROW & Permits	57,924	101,014	43,090
GMA	2,156,597	1,553,050	(603,547)
Total Direct Costs	22,174,864	13,413,070	(8,761,794)

Table 5: Estimated and Actual Indirect Costs, Total Costs, and Variances

Indirect Costs/Total Costs (\$)	Estimate	Actuals	Delta Over/(Under)
Overheads	1,612,796	1,203,060	(409,736)
AFUDC	1,625,561	134,981	(1,490,580)
Property Taxes	372,432	23,232	(349,200)
Total Indirect Costs	3,610,789	1,361,273	(2,249,516)
Total Direct Costs	22,174,864	13,413,070	(8,761,794)
Total Loaded Costs	25,785,653	14,774,343	(11,011,310)

D. Disallowance

There was no disallowance for Supply Line 38-514 Replacement Project as there were no post-1955 segments included in the Project without records that provide the minimum information to demonstrate compliance with then applicable industry standards or regulatory strength testing and recordkeeping requirements.

⁶ Actual Material and Construction Contractor costs exclude the cost of upsizing the pipe.

Pipeline Safety Enhancement Plan Final Report
Supply Line 38-514 Replacement Project

V. CONCLUSION

SoCalGas and SDG&E enhanced the safety of their integrated natural gas transmission system by prudently executing the Supply Line 38-514 Replacement Project. Through this Replacement Project, SoCalGas and SDG&E successfully installed 2.930 miles of pipeline in Fresno County. The total loaded cost of the Project is \$14,774,343.

SoCalGas and SDG&E executed this project prudently by including the Replacement of Accelerated pipe that would not impact the Planning, Design, and Construction of the Project to limit additional costs that otherwise would have been incurred for a separate project in the same location.

SoCalGas and SDG&E engaged in prudent cost avoidance efforts by moving the Construction Contractor to work on Supply Line 38-514 Section 1 to avoid standby charges during delays to Section 2, and roping the pipeline beneath utilities where possible, reducing the material and construction costs.

End of Supply Line 38-514 Replacement Project Final Report

Pipeline Safety Enhancement Plan Final Report
Supply Line 38-931 Replacement Project

I. SUPPLY LINE 38-931 REPLACEMENT PROJECT

A. Background and Summary

Supply Line 38-931 is a predominantly [REDACTED] diameter transmission line that traverses through orchards and crop land approximately two miles within the unincorporated community of Buttonwillow in Kern County. The pipeline is primarily routed across a Class 1 location. This report describes the activities associated with the Supply Line 38-931 Replacement Project, that consists of the replacement and reroute of 2.406 miles of pipeline, the derate of approximately 1.391 miles, a jack and bore of approximately 327 feet under Interstate 5, and the installation of a new regulator station. The specific attributes for this Project are detailed in Table 1 below. The total loaded cost of the Project is \$7,466,791.

Pipeline Safety Enhancement Plan Final Report
Supply Line 38-931 Replacement Project

Table 1: General Project Information

Project Name		Supply Line 38-931		
Project Type	Replacement			
Length	2.406 miles			
Location	Unincorporated Buttonwillow, Kern County			
Class	1			
MAOP (<i>confidential</i>)	[REDACTED]			
Pipe Vintage	1942			
Construction Start	01/09/2017			
Construction Finish	03/31/2017			
Original Pipe Diameter (<i>confidential</i>)	[REDACTED]			
New Diameter (<i>confidential</i>)	[REDACTED]			
Original SMYS ¹ (<i>confidential</i>)	[REDACTED]			
New SMYS (<i>confidential</i>)	[REDACTED]			
Project Costs (\$)	Capital	O&M	Total	
Loaded Project Costs	7,466,791	-	7,466,791	
Disallowed Costs	-	-	-	

¹ Highest percentage of Specified Minimum Yield Strength (SMYS) of Category 4 Criteria pipe.

Pipeline Safety Enhancement Plan Final Report
Supply Line 38-931 Replacement Project

B. Maps and Images

Figure 1: Satellite Image of Supply Line 38-931 Replacement Project

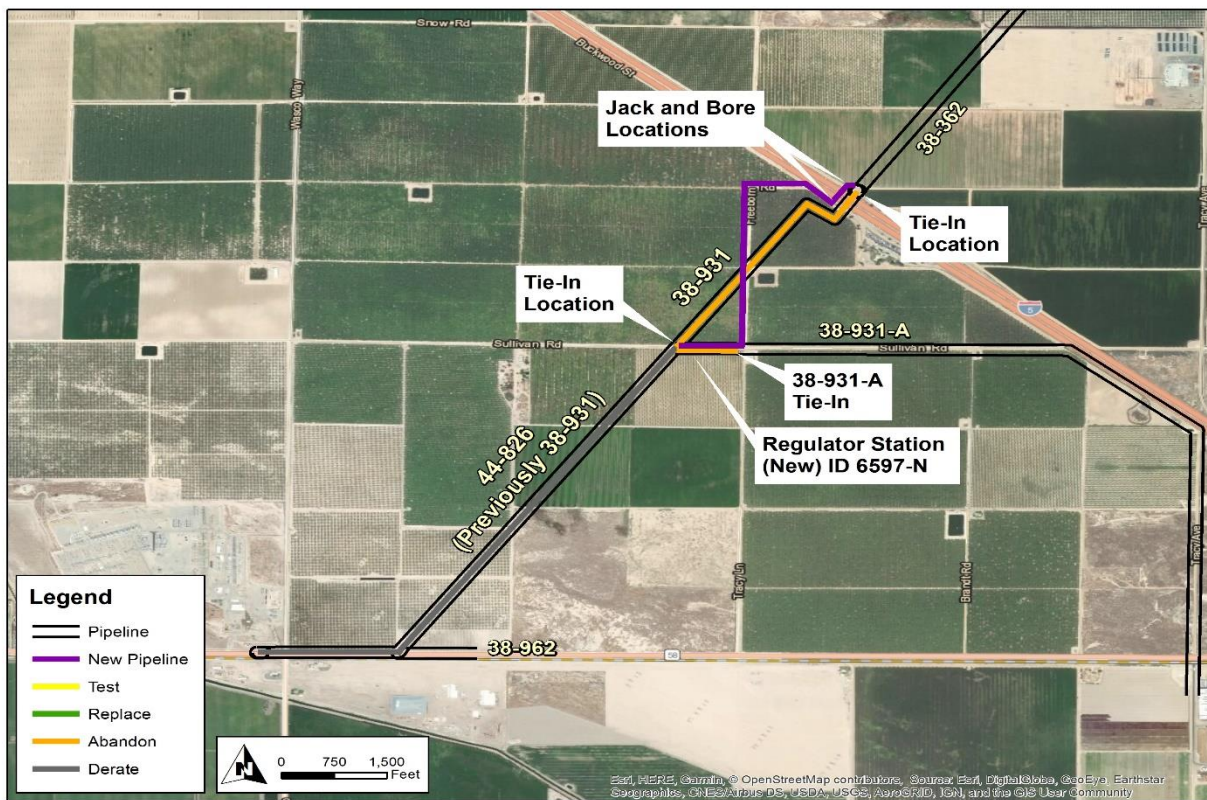

Pipeline Safety Enhancement Plan Final Report Supply Line 38-931 Replacement Project

Figure 2: Overview Map of Supply Line 38-931 Replacement Project

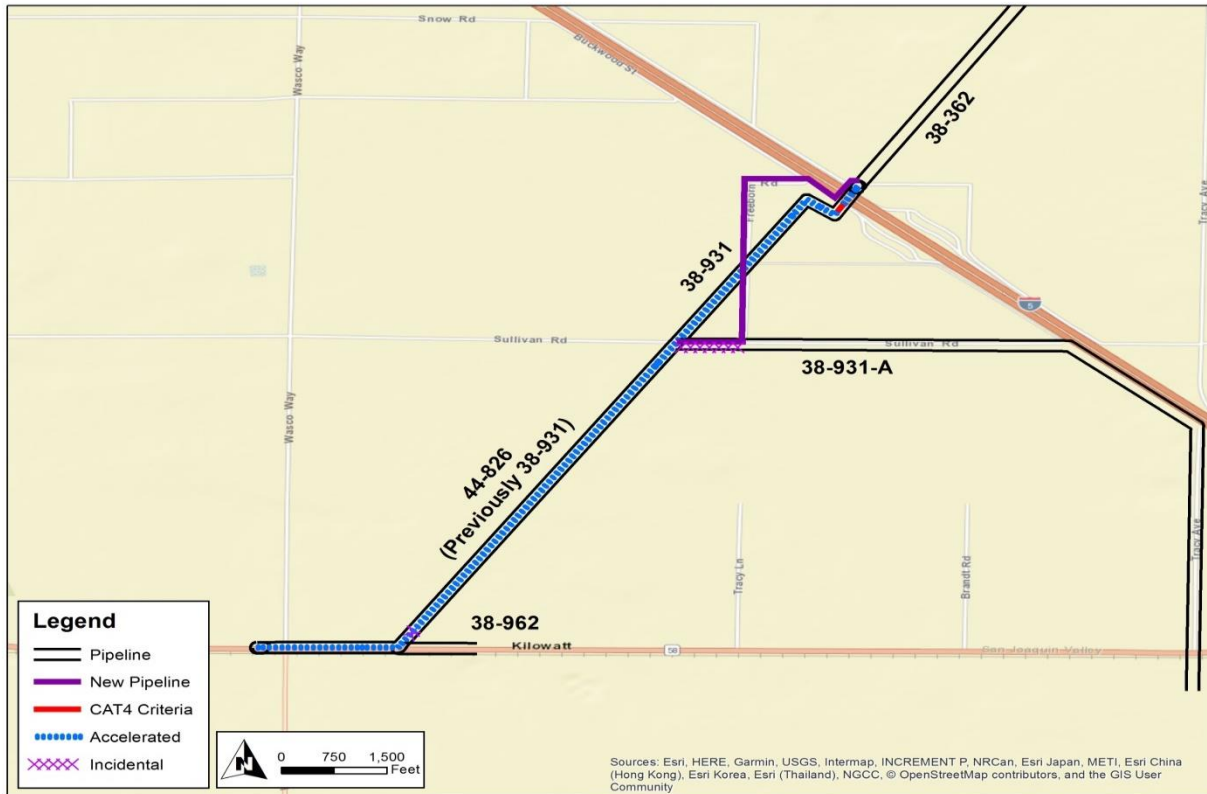

Pipeline Safety Enhancement Plan Final Report
Supply Line 38-931 Replacement Project

II. ENGINEERING, DESIGN, AND PLANNING

A. Project Scope

Table 2: Mileage Information

	Criteria	Accelerated ²	Incidental	New	Total ³
Final Mileage	0.028 mi.	2.138 mi.	0.194 mi.	0.046 mi.	2.406 mi.
	146 ft.	11,291 ft.	1,023 ft.	242 ft.	12,702 ft.

SoCalGas and SDG&E presented a conceptual project scope in workpapers supporting the 2011 PSEP filing⁴, however, at that time, it did not identify Supply Line 38-931 as a PSEP Project. Prior to initiating execution of the Project in 2017, SoCalGas and SDG&E reviewed existing pipeline records and determined that Supply Line 38-931 contained Category 4 Criteria mileage that should be remediated as a Phase 1A project. During the Engineering, Design, and Planning phase, SoCalGas and SDG&E further refined the scope. The progression of project scope is summarized as follows:

1. 2011 PSEP Filing: SoCalGas and SDG&E did not identify Supply Line 38-931 in the 2011 PSEP filing.
2. Scope Validation: Through scope validation activities, after the 2011 filing and before initiating execution of the Project, SoCalGas and SDG&E identified 146 feet of Category 4 Criteria pipe and added this as a PSEP Phase 1A project.

² Accelerated mileage includes Phase 1B and Phase 2A. Phase 2A includes pipelines without sufficient record of a pressure test in less populated areas. The Accelerated mileage was included to realize efficiencies and to enhance project constructability.

³ Values may not add to total due to rounding.

⁴ See Amended PSEP of SoCalGas and SDG&E, submitted December 2, 2011, in R.11-02-019 and subsequently transferred to A.11-11-002.

Pipeline Safety Enhancement Plan Final Report
Supply Line 38-931 Replacement Project

3. Engineering, Design, and Constructability:

a. Four Project options were analyzed:

- i. Replace Phase 1A portions, and return in 2 – 3 years to abandon.
- ii. Replace Phase 1A portion with partial acceleration of Phase 1B pipe.
- iii. Replace Phase 1A portion with acceleration of all Phase 1B pipe.
- iv. Two mobilization option – executing option ii in one mobilization, and then the remaining Phase 1B in a second mobilization.

b. The final option selected was to remediate all Phase 1A and Phase 1B portions in one mobilization and demobilization (option iii above) as this was the most cost-efficient option. This included 42 feet of Incidental pipe, and 2.125 miles of Accelerated Phase 1B pipe.

4. Final Project Scope: The final project scope consisted of a replacement and reroute of 2.406 miles of pipeline, the derating of 1.391 miles, a jack and bore of 327 feet under Interstate 5, and the installation of a new regulator station. The Accelerated mileage consists of 2.122 miles of Phase 1B pipe, 87 feet of Phase 2A pipe, and 0.194 miles of Incidental pipe.

B. Decision Tree Analysis

SoCalGas and SDG&E performed a PSEP Decision Tree analysis of Supply Line 38-931 and confirmed the project design should commence as a Replacement Project.

Pipeline Safety Enhancement Plan Final Report
Supply Line 38-931 Replacement Project

Pipeline segments installed prior to 1946 that are not capable of being assessed using in-line inspection technology are identified for replacement under the approved PSEP Decision Tree. As explained in the testimony supporting the approved PSEP, as part of the work previously completed during implementation federal gas transmission pipeline integrity management regulations (49 CFR 192, Subpart O), SoCalGas and SDG&E have already identified, retrofitted and in-line inspected pre-1946 transmission pipelines that were constructed using acceptable welding techniques and are operationally suited to in-line inspection. The remaining pre-1946 segments in the SoCalGas/SDG&E system are not suited for in-line inspection, likely have non-state-of-the-art welds, and would require significant investment for retrofitting to accommodate in-line inspection tools. Accordingly, consistent with the Commission’s directive in D.11-06-017 to “address retrofitting pipeline to allow for inline inspection tools,” the requirement in California Public Utilities Code section 958 that upon completion of the PSEP, where warranted, pipelines are to be capable of accommodating in-line inspection devices, and the overarching objectives of PSEP to enhance the safety of the pipeline system in a proactive, cost effective manner, the approved PSEP Decision Tree identifies pre-1946 non-piggable pipeline segments for abandonment and/or replacement.

Through this Decision Tree analysis, SoCalGas and SDG&E determined replacement as the more prudent option. Key considerations that support SoCalGas and SDG&E’s determination to replace this segment include:

1. Shut-In Analysis: The Project Team completed a Request for Engineering Review (RER) analysis and concluded that the line could be shut-in as long as the four high pressure customer taps and the one pressure district could be back fed with compressed natural gas (CNG) / liquified natural gas (LNG), as there were no alternate feeds for these customers.

Pipeline Safety Enhancement Plan Final Report
Supply Line 38-931 Replacement Project

It was also recommended by the Operating District to conduct construction activities between late fall and early summer conditions, which were inactive months for one of the high-pressure customers.

2. Piggability: Non-piggable.
3. Pipe Vintage: 1942.
4. Existing Pipe Attributes: Two pressure control fittings (PCFs) on the existing line making the pipeline non-piggable.
5. Longseam Type: Unknown.

C. Engineering, Design, and Planning Factors

SoCalGas and SDG&E reviewed pipeline drawings and other information, contacted internal planning groups, communicated with external stakeholders, conducted survey activities, including reviewing public records, ground penetrating radar (GPR), and potholing of the area to confirm the presence of underground utilities and substructures, and completed a pre-design site walk. Key factors that influenced the engineering and design of the Project are as follows:

1. Shut-In Analysis: The Project Team completed an additional RER analysis and concluded that shut-in of the line and providing the customers CNG/LNG was not necessary, as all tie-ins could be performed by tapping into active lines utilizing PCFs.
2. Customer Impacts: There were no impacts to the four high pressure customer taps and one pressure district as tie-ins were performed utilizing PCFs.

Pipeline Safety Enhancement Plan Final Report
Supply Line 38-931 Replacement Project

3. Reroute: The Project Team designed the reroute of the new Supply Line 38-931 along dirt roads, in order to reduce the risk of third party damage due to “ripping” operations that normally occur in agricultural areas. Ripping is a term used to describe the practice of mechanically plowing fields.
4. Diameter Changes: The original existing pipeline had a [REDACTED] diameter. SoCalGas and SDG&E analyzed typical load demands and future capacity planning for a replacement diameter of [REDACTED] and determined it to be sufficient.
5. Known Substructures: Potholing confirmed the existence of irrigation lines for which the design incorporated avoiding space conflicts.
6. Permit Conditions: Kern County permits were anticipated for the work along Sullivan Road. Caltrans permits were required for the jack and bore under the Interstate 5.
7. Land Use: Outside of the areas that required permits above, the majority of the work areas were identified within private properties that would require temporary rights of entry (TRE), and permanent easements for the new pipeline route. A small portion of the work was completed within SoCalGas and SDG&E’s Buttonwillow Valve Station and Bowerbank Plant.
8. Environmental: The following were planned for:
 - a. Encountering special status species of wildlife at or near the project site.
 - b. Implementing Dust Control Plan (DCP), Hazardous Materials Business Plan (HMBP), and Storm Water Pollution Prevention Plan (SWPPP) requirements.
 - c. Removing coatings presumed to contain asbestos fibers (e.g., coal tar wrap) or heavy metals (e.g., paint).

Pipeline Safety Enhancement Plan Final Report
Supply Line 38-931 Replacement Project

9. Valves: The following valve work was planned for:
- a. A preexisting [REDACTED] tap valve for Supply Line 38-931-A would be replaced for tie-over to new Supply Line 38-931.
 - b. Six preexisting valves within the above ground meter station would be abandoned or removed as part of the replacement work.
 - c. Three new valves to be installed – two [REDACTED] valves to serve as fire control valves for the new regulator station and one [REDACTED] valve for the existing regulator station tie-over at the north tie-in.

Pipeline Safety Enhancement Plan Final Report Supply Line 38-931 Replacement Project

Figure 3: Schematic of Supply Line 38-931 North Tie-In

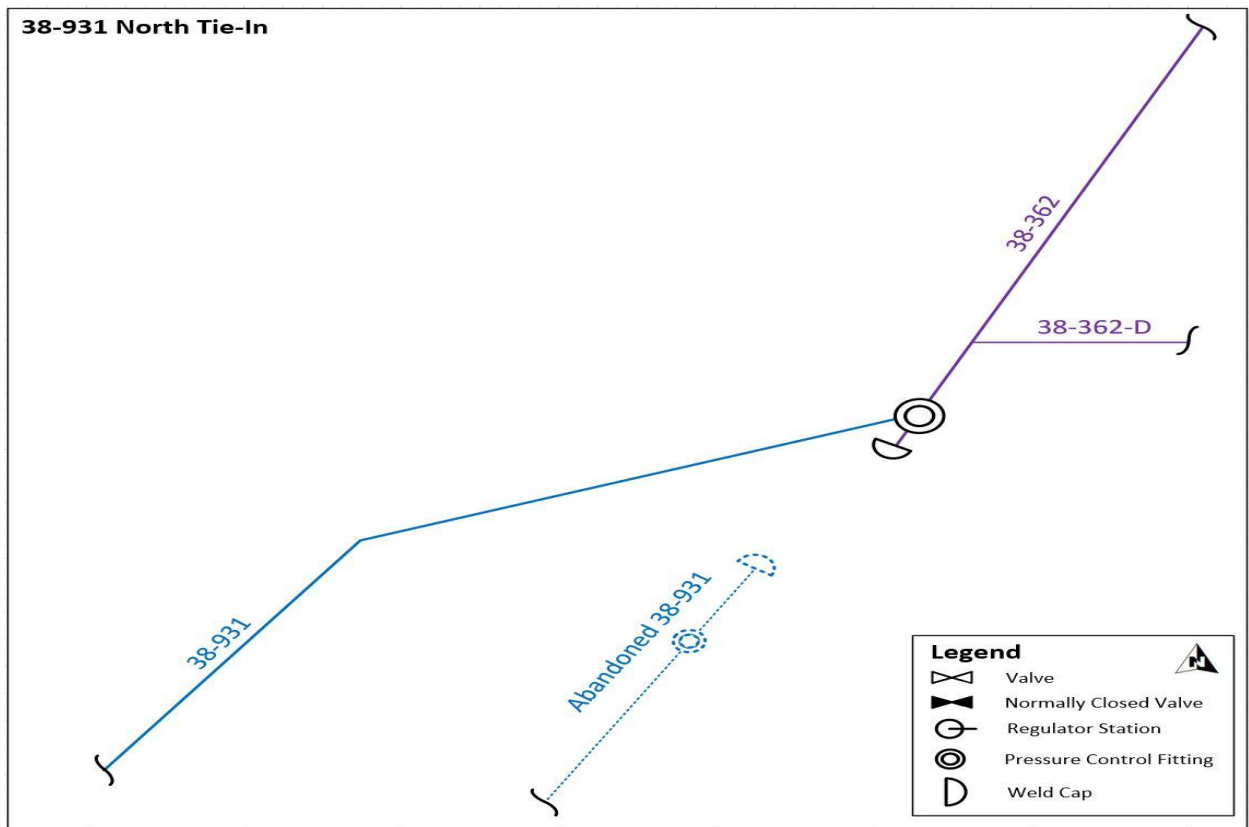

Pipeline Safety Enhancement Plan Final Report Supply Line 38-931 Replacement Project

Figure 4: Schematic of Supply Line 38-931 South Tie-In

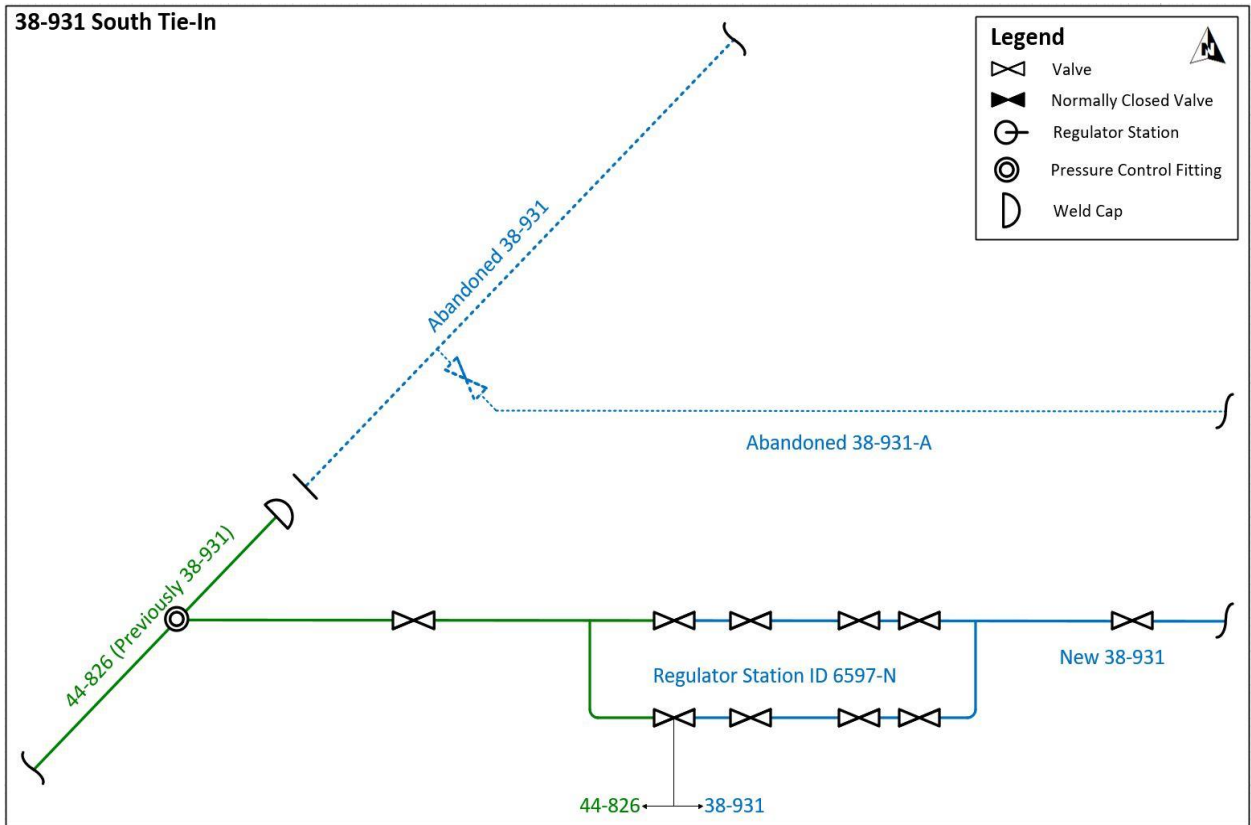

Pipeline Safety Enhancement Plan Final Report
Supply Line 38-931 Replacement Project

D. Scope Changes

SoCalGas and SDG&E did not make any notable scope changes during detailed design.

Pipeline Safety Enhancement Plan Final Report
Supply Line 38-931 Replacement Project

III. CONSTRUCTION

A. Construction Contractor Selection

The Project Team prepared an initial cost estimate based on the preliminary design. Following completion of the engineering, design, and planning activities described above, the Project Team directed the Performance Partner to prepare cost estimates based on a more detailed engineering design package. As indicated above, there were no notable changes in scope between the time when the Project Team prepared the preliminary cost estimate and when the Performance Partner prepared and submitted its Target Price Estimate. SoCalGas and SDG&E awarded the construction contract to the Performance Partner.

1. SoCalGas and SDG&E’s Preliminary Construction Cost Estimate (confidential):
SoCalGas and SDG&E’s preliminary estimate for construction was [REDACTED].
2. Construction Contractor’s Target Price Estimate (confidential): The Construction Contractor’s cost estimate was [REDACTED], which was [REDACTED] than SoCalGas and SDG&E’s preliminary cost estimate for construction.

B. Construction Schedule

Table 3: Construction Timeline

Construction Start Date	01/09/2017
Construction Completion Date	03/31/2017
NOP Date	03/13/2017

C. Changes During Construction

SoCalGas and SDG&E successfully mitigated conditions during construction in a manner that minimized potential impacts on project scope, cost, and schedule. As a result, these conditions did not result in any notable change orders.

Pipeline Safety Enhancement Plan Final Report
Supply Line 38-931 Replacement Project

Figure 5: Tie-In to Existing [REDACTED] Line



Pipeline Safety Enhancement Plan Final Report
Supply Line 38-931 Replacement Project

Figure 6: Regulator Station Vault



Pipeline Safety Enhancement Plan Final Report
Supply Line 38-931 Replacement Project

Figure 7: Welding Plate on Abandoned [REDACTED] Line



Pipeline Safety Enhancement Plan Final Report Supply Line 38-931 Replacement Project

Figure 8: [REDACTED] Line Prior to Cut and Cap



Pipeline Safety Enhancement Plan Final Report
Supply Line 38-931 Replacement Project

Figure 9: Fittings Wrapped



Pipeline Safety Enhancement Plan Final Report
Supply Line 38-931 Replacement Project

Figure 10: Slurry Backfill



Pipeline Safety Enhancement Plan Final Report
Supply Line 38-931 Replacement Project

D. Commissioning and Site Restoration

Commissioning activities include restoration of the site, final inspection, and placement of the pipeline back into service, transportation, and disposal of hydrotested water and hazardous material, and site demobilization. Closeout activities include development of final drawings, finalization of a reconciliation package, and updates to company recordkeeping systems to reflect the completed scope of work.

Pipeline Safety Enhancement Plan Final Report
Supply Line 38-931 Replacement Project

IV. PROJECT COSTS

A. Cost Avoidance Actions

SoCalGas and SDG&E exercised due diligence in the planning, design, and construction activities for this project to minimize or avoid costs when prudent to do so. As discussed above, the Project Team conducted a site visit to identify and incorporate discernible site conditions into the engineering, design, and planning of the Project. Specific examples of cost avoidance actions taken on this project are:

1. Engineering and Design:
 - a. The design option that was selected, routing the Phase 1A pipe out of the existing orchard along a roadway and accelerating replacement of the Phase 1B pipe, eliminated the future cost of a second construction mobilization and demobilization that would have been scheduled within the near term.
 - b. By derating a portion of the line to operate below 20% SMYS, the Project Team minimized the length of pipe that needed to be replaced, and avoided additional engineering and design costs to explore alternate route options, potholing and additional CalTrans permitting costs.
2. Construction Execution: The Project Team replaced the box sag with a bell hole excavation, resulting in a credit from the Construction Contractor, the schedule was brought forward by a day as less welding and backfilling was required, and a tie-in was eliminated.

Pipeline Safety Enhancement Plan Final Report
Supply Line 38-931 Replacement Project

B. Cost Estimate

Based on the preliminary design, once the project scope was confirmed and engineering, design, and planning activities were underway, SoCalGas and SDG&E prepared an estimate of the Direct Costs of the Project in the amount of \$7,898,027. This estimate was prepared in October of 2016, using the “SCG Pipeline Estimate Template Rev 3” estimating tool, the most current version of the PSEP Estimate Template at the time. The Project Team considered the conditions known at the time to prepare the preliminary Direct Cost estimate. This estimate reflects the projected Labor, Material, and Services costs anticipated to be incurred to execute the Project.

SoCalGas and SDG&E estimated Indirect Costs of the Project based on the estimated Direct Costs and other project-related variables.

C. Actual Direct and Indirect Costs

Actual Direct Costs reflect the Labor, Material, and Service costs incurred to execute the Project. Actual Indirect Costs reflect costs for incremental overhead loaders in accordance with Company overhead allocation policies. The total loaded cost of the Project is \$7,466,791.

Pipeline Safety Enhancement Plan Final Report
Supply Line 38-931 Replacement Project

Table 4: Estimated and Actual Direct Costs and Variances

Direct Costs (\$)	Estimate	Actuals	Delta Over/(Under)
Company Labor	516,859	280,587	(236,272)
Materials	408,781	465,688	56,907
Construction Contractor	3,855,808	2,851,665	(1,004,143)
Construction Management & Support	580,254	373,462	(206,792)
Environmental	201,381	148,575	(52,806)
Engineering & Design	1,109,469	1,413,194	303,725
Project Management & Services	349,918	98,776	(251,142)
ROW & Permits	157,555	194,905	37,350
GMA	718,002	744,306	26,304
Total Direct Costs	7,898,027	6,571,158	(1,326,869)

Table 5: Estimated and Actual Indirect Costs, Total Costs, and Variances

Indirect Costs/Total Costs (\$)	Estimate	Actuals	Delta Over/(Under)
Overheads	704,445	685,054	(19,391)
AFUDC	1,479,360	184,718	(1,294,642)
Property Taxes	331,412	25,861	(305,551)
Total Indirect Costs	2,515,217	895,633	(1,619,584)
Total Direct Costs	7,898,027	6,571,158	(1,326,869)
Total Loaded Costs	10,413,244	7,466,791	(2,946,453)

D. Disallowance

There was no disallowance for Supply Line 38-931 as there were no post-1955 segments included in the Project without records that provide the minimum information to demonstrate compliance with then applicable industry standards or regulatory strength testing and recordkeeping requirements.

Pipeline Safety Enhancement Plan Final Report
Supply Line 38-931 Replacement Project

V. CONCLUSION

SoCalGas and SDG&E enhanced the safety of their integrated natural gas transmission system by prudently executing the Supply Line 38-931 Replacement Project. Through this Replacement Project, SoCalGas and SDG&E successfully remediated 2.406 miles and installed a regulator station in the unincorporated community of Buttonwillow in Kern County. The total loaded cost of the Project is \$7,466,791.

SoCalGas and SDG&E executed this project prudently by analyzing four design options, selected the option that derated a portion of the pipe in order to lessen the amount of pipe that required remediation, and accelerated Phase 1B pipe thus remediating all the PSEP pipe and avoiding a second construction effort. SoCalGas and SDG&E rerouted the transmission pipe from under an orchard onto the easement along a roadway, which is safer and provides better access for future maintenance.

SoCalGas and SDG&E engaged in prudent cost avoidance efforts by making the determination in the field to revise construction methods by replacing the box sag with a bell hole excavation that resulted in less welding, backfilling, eliminated a tie-in, and revised the alignment at the north tie-in.

End of Supply Line 38-931 Replacement Project Final Report

Pipeline Safety Enhancement Plan Final Report
Supply Line 41-17 Replacement Project

I. SUPPLY LINE 41-17 REPLACEMENT PROJECT

A. Background and Summary

Supply Line 41-17 is a predominantly [REDACTED] diameter transmission line that runs approximately 15 miles between Moreno Valley and Hemet. Although the pipeline traverses class 3 locations and high consequence areas (HCAs), the pipeline is primarily routed across Class 1 locations, through a mix of agricultural land, undeveloped land, commercial, and industrial areas. This report describes the activities associated with Supply Line 41-17 Project, which runs along North Ramona Boulevard in San Jacinto, and consists of the replacement of 2.620 miles of pipeline. The specific attributes of this Project are detailed in Table 1 below. The total loaded cost of the Project is \$2,743,703.

Pipeline Safety Enhancement Plan Final Report
Supply Line 41-17 Replacement Project

Table 1: General Project Information

Project Name		Supply Line 41-17		
Project Type	Replacement			
Length	2.620 miles			
Location	San Jacinto			
Class	3			
MAOP (<i>confidential</i>)	[REDACTED]			
Pipe Vintage	1955			
Construction Start	09/15/2016			
Construction Finish	02/09/2017			
Original Pipe Diameter (<i>confidential</i>)	[REDACTED]			
New Diameter (<i>confidential</i>)	N/A			
Original SMYS ¹ (<i>confidential</i>)	[REDACTED]			
New SMYS (<i>confidential</i>)	[REDACTED] ²			
Project Costs (\$)	Capital	O&M	Total	
Loaded Project Costs	2,743,551	153	2,743,703	
Disallowed Costs	-	-	-	

¹ Highest percentage of Specified Minimum Yield Strength (SMYS) of Category 4 Criteria pipe.

² New SMYS for newly installed section only.

Pipeline Safety Enhancement Plan Final Report
Supply Line 41-17 Replacement Project

B. Maps and Images

Figure 1: Satellite Image of Supply Line 41-17 Replacement Project

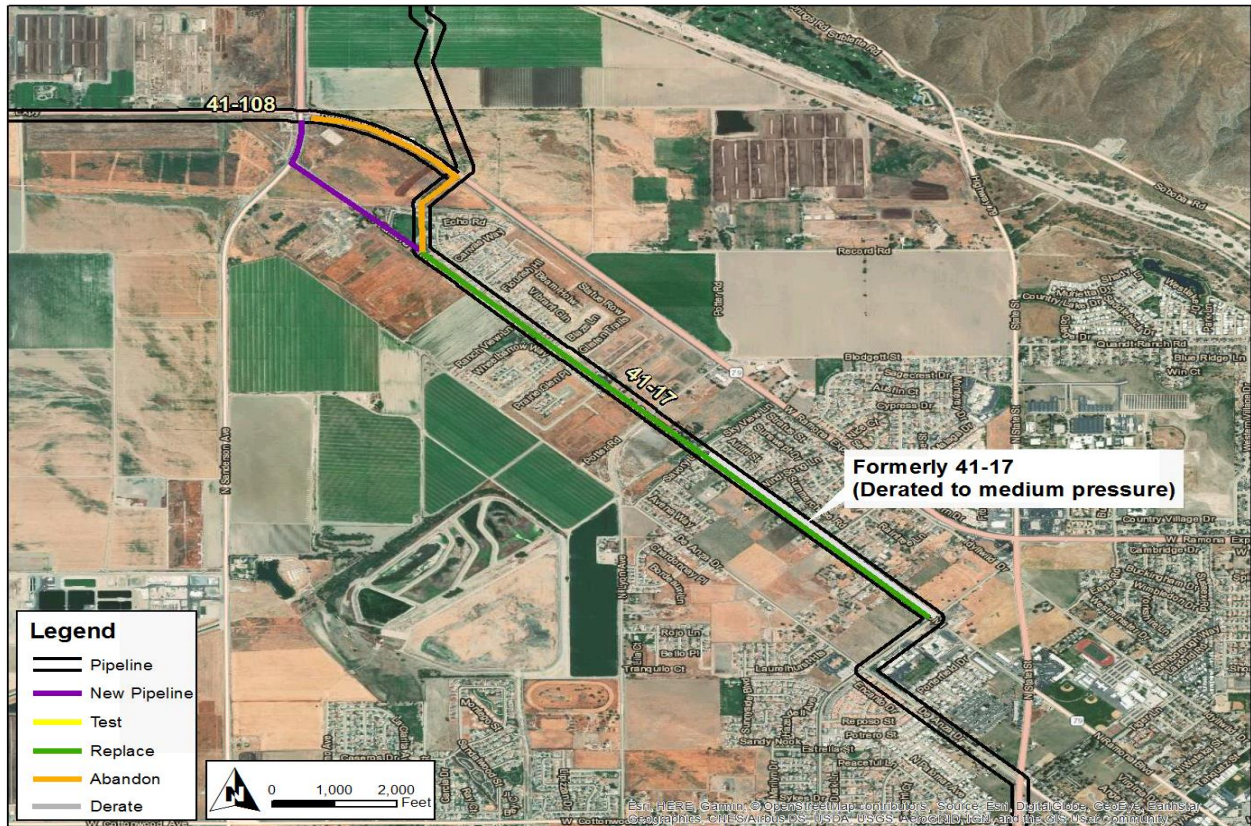

Pipeline Safety Enhancement Plan Final Report Supply Line 41-17 Replacement Project

Figure 2: Overview Map of Supply Line 41-17 Replacement Project

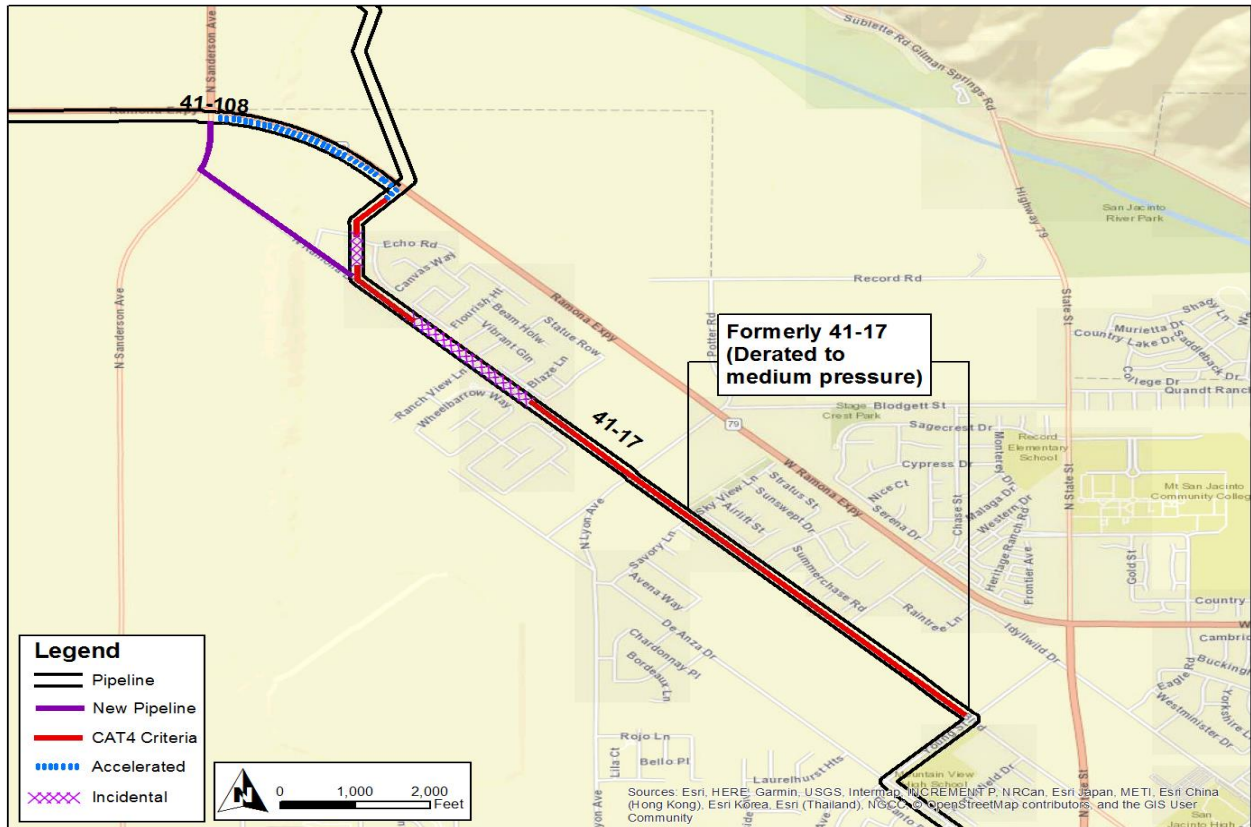

Pipeline Safety Enhancement Plan Final Report Supply Line 41-17 Replacement Project

Figure 3: Satellite Image of Supply Line 41-17 Abandonment, Derate, and New Sections

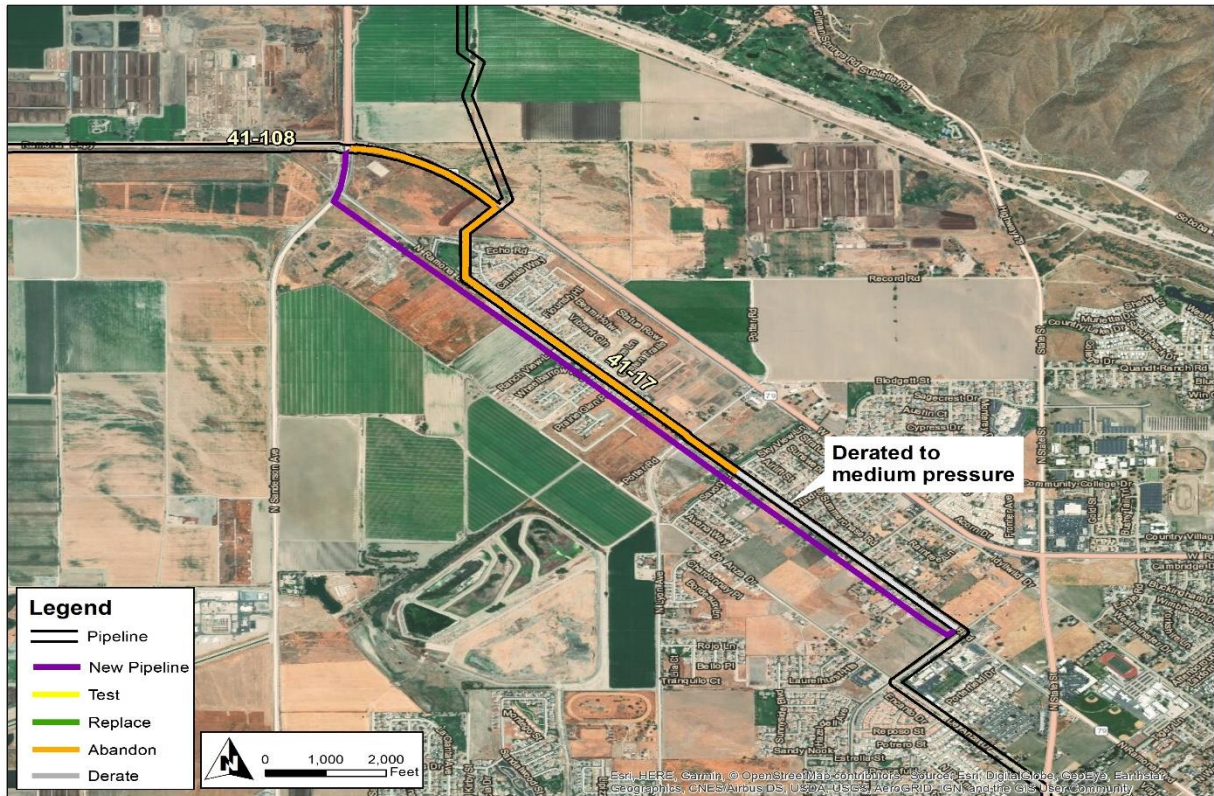

Pipeline Safety Enhancement Plan Final Report
Supply Line 41-17 Replacement Project

II. ENGINEERING, DESIGN, AND PLANNING

A. Project Scope

Table 2: Mileage Information

	Criteria	Accelerated ³	Incidental	Total ⁴
Final Mileage	1.688 mi.	0.557 mi.	0.374 mi.	2.620 mi.
	8,912 ft.	2,943 ft.	1,977 ft.	13,831 ft.

SoCalGas and SDG&E presented a conceptual project scope in workpapers supporting the 2011 PSEP filing.⁵ Prior to initiating execution of the Project in 2016, SoCalGas and SDG&E reviewed existing pipeline records to validate the scope of the Project. During the Engineering, Design, and Planning phase, SoCalGas and SDG&E further refined the scope. This progression of the project scope is summarized as follows:

1. 2011 PSEP Filing: SoCalGas and SDG&E identified Supply Line 41-17 as a Phase 1A Replacement Project comprised of 1.686 miles of Category 4 Criteria pipe and 1.889 miles of Accelerated pipe.
2. Scope Validation: Through scope validation activities, after the 2011 filing, SoCalGas and SDG&E increased the scope of this project to include an additional 10 feet of Category 4 Criteria pipe.

³ Accelerated mileage includes Phase 2A and Phase 2B pipe. Phase 2 includes pipelines without sufficient record of a pressure test in less populated areas (Phase 2A) or pipelines with record of a pressure test, but without record of a pressure test to modern – Subpart J – standards (Phase 2B). The Accelerated mileage was included to realize efficiencies and to enhance project constructability.

⁴ Values may not add to total due to rounding.

⁵ See Amended PSEP of SoCalGas and SDG&E, submitted December 2, 2011, in R.11-02-019 and subsequently transferred to A.11-11-002.

Pipeline Safety Enhancement Plan Final Report
Supply Line 41-17 Replacement Project

3. Engineering, Design, and Constructability: The Project Team initiated communications with internal stakeholders early on and determined the Operating District was in the initial planning stages for a project that could also address the PSEP scope. The Operating District identified the need to upsize Supply Line 41-17 to support an operationally-constrained area and had initiated a project to replace portions of Supply Line 41-17 with larger diameter pipe. The initial PSEP plan to hydrotest the existing line would address the PSEP scope but would not address the operationally-constrained area identified by the Operating District. In addition, there was a proposed roadway widening project along the Ramona Expressway that would have potentially required a relocation of a portion of Supply Line 41-17, after the completion of pressure testing as part of PSEP. Taking these factors into consideration, SoCalGas and SDG&E determined that hydrotesting the Category 4 Criteria footage within Supply Line 41-17 solely to address PSEP requirements, and then subsequently completing a replacement project to address operational constraints and the roadway widening project, would not be the most cost-effective approach for customers. SoCalGas and SDG&E determined the most cost-effective approach would be to design the project to address all three objectives in a single project.

4. Final Project Scope: The final project scope consists of the abandonment of a 1.790-mile portion of pipe, the derate of a 0.830-mile portion of pipe which addressed the 1.688 Category 4 Criteria mileage after Supply Line 41-17 was rerouted.

B. Decision Tree Analysis

SoCalGas and SDG&E performed an analysis of Supply Line 41-17 and confirmed the project design should commence as a hydrotest project.

Pipeline Safety Enhancement Plan Final Report
Supply Line 41-17 Replacement Project

For pipeline segments longer than 1,000 feet in length, under the approved PSEP Decision Tree, SoCalGas and SDG&E complete a preliminary review to determine whether SoCalGas and SDG&E can manage customer service impacts if the pipeline segment is taken out of service for a period of two to six weeks to complete pressure testing. Where mitigation of customer impacts to remove the line from service for pressure testing is feasible, SoCalGas and SDG&E compare the costs, constructability, risks, and benefits of pressure testing and replacement to determine whether pressure testing or replacement is the more prudent option.

As discussed above, SoCalGas and SDG&E determined it would not be cost-effective to perform a hydrotest of Supply Line 41-17, but rather, it would be more cost-effective for customers to address PSEP requirements through completion of a more comprehensive project that addresses not only the PSEP requirements, but also the identified need to install a larger diameter pipeline section to address operationally-constrained area, and a proposed roadway widening project along the Ramona Expressway that would have potentially required a relocation of a portion of Supply Line 41-17. As part of this more comprehensive project, the Category 4 segments were identified for abandonment or derating to medium pressure.

C. Engineering, Design, and Planning Factors

SoCalGas and SDG&E completed detailed engineering reviewed pipeline drawings and other information, contacted internal planning groups, communicated with external stakeholders, conducted survey activities, including reviewing public records of the area to confirm the presence of underground utilities and substructures, and completed a pre-design site walk. Key factors that influenced the engineering and design of the Project are as follows:

Pipeline Safety Enhancement Plan Final Report
Supply Line 41-17 Replacement Project

1. Abandonment/Derate Coordination: The Operating District planned and executed the Project to install larger diameter pipe (██████ versus ██████) as a non-PSEP project and the PSEP Project Team reviewed design packages to evaluate the Category 4 PSEP segments included in the abandonment and derate portions of the final project.
2. Schedule Coordination: As discussed above, the Project Team initiated communications with stakeholders within SoCalGas and SDG&E and external to PSEP early on and identified that the PSEP scope could be more cost-effectively addressed in conjunction with a project being planned by the Operating District.

D. Scope Changes

Through engineering, design, and planning activities, SoCalGas and SDG&E determined that changes in scope were appropriate to more cost effectively address both PSEP and operational requirements. As a result, the preliminary cost estimate does not fully reflect the final scope. For the reasons discussed previously, the original plan to hydrotest was not pursued and SoCalGas and SDG&E opted to execute a more comprehensive project that included replacement of Supply Line 41-17 with larger diameter pipeline to address the operationally-constrained area, abandon/derate the Category 4 sections of pipe to meet the PSEP objectives, and relocate portions of Line 41-17 in anticipation of a potential roadway widening project along the Ramona Expressway.

Based on this scope change, SoCalGas and SDG&E determined the estimated cost to hydrotest the pipeline to be a reasonable estimate of the portion of costs attributable to the PSEP scope of work. Accordingly, this amount of the overall costs is allocated as the PSEP-related cost.

Pipeline Safety Enhancement Plan Final Report
Supply Line 41-17 Replacement Project

III. CONSTRUCTION

A. Construction Contractor Selection

SoCalGas and SDG&E's Operating District selected a contractor from a competitively bid Master Service Agreement (MSA) to perform the specified work.

1. SoCalGas and SDG&E's Preliminary Construction Cost Estimate (confidential):
SoCalGas and SDG&E's preliminary cost estimate for construction was [REDACTED] for hydrotesting the existing pipeline.
2. Construction Contractor's Price Estimate: There was no Construction Contractor cost estimate for this projects as it was completed as a replacement project on a Time and Expense basis.

B. Construction Schedule

Table 3: Construction Timeline

Construction Start Date	09/15/2016
Construction Completion Date	02/09/2017
NOP Date	12/28/2016

C. Changes During Construction

There were no conditions that were raised by the SoCalGas and SDG&E Operating District that resulted in any notable change orders.

Pipeline Safety Enhancement Plan Final Report
Supply Line 41-17 Replacement Project

D. Commissioning and Site Restoration

Commissioning activities include restoration of the site, final inspection and placement of the pipeline back into service, transportation and disposal of hydrotested water and hazardous material, and site demobilization. Closeout activities include development of final drawings, finalization of a reconciliation package, and updates to company recordkeeping systems to reflect the completed scope of work.

Pipeline Safety Enhancement Plan Final Report
Supply Line 41-17 Replacement Project

IV. PROJECT COSTS

A. Cost Avoidance Actions

SoCalGas and SDG&E exercised due diligence in the planning, design, and construction activities for this project to minimize or avoid costs when prudent to do so. The Operating District conducted a site visit to identify and incorporate discernible site conditions into the engineering, design, and planning of the Project. A specific example of cost avoidance action taken on this project is the decision to not hydrotest the preexisting line once it was determined that a portion of the tested pipeline would eventually be replaced or abandoned as part of an Operating District Project and a roadway expansion project. The expense to hydrotest Supply Line 41-17 would have been a short-term solution, with the pending pipeline upsize and potential relocation projects to be executed in the near future. By addressing the scopes of work comprehensively as a single project, SoCalGas and SDG&E reduced overall costs for the benefit of customers.

B. Cost Estimate

Based on the preliminary design, once the project scope was confirmed and engineering, design, and planning activities were underway, SoCalGas and SDG&E prepared an estimate of the Direct Costs of the Project in the amount of \$2,205,336 for Hydrotesting. As discussed above, SoCalGas and SDG&E determined the estimated cost to hydrotest the pipeline to be a reasonable estimate of the portion of the overall project costs attributable to the PSEP scope of work. Accordingly, this amount of the overall costs is allocated as the PSEP-related cost.

Pipeline Safety Enhancement Plan Final Report
Supply Line 41-17 Replacement Project

C. Actual Direct and Indirect Costs

Actual Direct Costs for this project reflects the pre-determined and agreed to cost PSEP would contribute to completing the Operating District project. Actual Indirect Costs reflect costs for incremental overhead loaders in accordance with Company overhead allocation policies. The total loaded cost of the PSEP portion of the Project is \$2,743,703.

Table 4: Estimated and Actual Direct Costs and Variances

Direct Costs (\$)	Estimate	Actuals ⁶	Delta Over/(Under)
Company Labor	120,658	11,182	(109,476)
Materials	88,608	-	(88,608)
Construction Contractor	1,251,734	2,200,000 ⁷	948,266
Construction Management & Support	7,130	-	(7,130)
Environmental	2,300	-	(2,300)
Engineering & Design	-	41,155	41,155
Project Management & Services	-	795	795
ROW & Permits	13,800	-	(13,800)
GMA	721,106	287,581	(433,525)
Total Direct Costs	2,205,336	2,540,713	335,377

⁶ Actual Material and Construction Contractor costs exclude the cost of upsizing the pipe.

⁷ Actual Contractor Costs for replacement, and abandonment, and derate activities exceeded \$2,200,000., PSEP agreed to fund \$2,200,000 of the Contractor Costs.

Pipeline Safety Enhancement Plan Final Report
Supply Line 41-17 Replacement Project

Table 5: Estimated and Actual Indirect Costs, Total Costs, and Variances

Indirect Costs/Total Costs (\$)	Estimate	Actuals	Delta Over/(Under)
Overheads	77,406	187,941	110,535
AFUDC	320,942	13,322	(307,620)
Property Taxes	65,788	1,727	(64,061)
Total Indirect Costs	464,136	202,990	(261,146)
Total Direct Costs	2,205,336	2,540,713	335,377
Total Loaded Costs	2,669,472	2,743,703	74,231

D. Disallowance

There was no disallowance for Supply Line 41-17 as there were no post-1955 segments included in the Project without records that provide the minimum information to demonstrate compliance with then applicable industry standards or regulatory strength testing and recordkeeping requirements.

Pipeline Safety Enhancement Plan Final Report
Supply Line 41-17 Replacement Project

V. CONCLUSION

SoCalGas and SDG&E enhanced the safety of their integrated natural gas transmission system by prudently executing the Supply Line 41-17 Replacement Project in conjunction with a Non-PSEP project that upsized the pipeline diameter to address an operational need and relocated the pipeline to address a potential street widening project. Through this Replacement Project, SoCalGas and SDG&E successfully addressed the Category 4 PSEP segments in the City of San Jacinto. The total loaded cost of the PSEP portion of the Project is \$2,743,703.

SoCalGas and SDG&E executed this project prudently through completing planning and design in conjunction with the Operating District, eliminating the potential for duplicative and redundant work.

SoCalGas and SDG&E engaged in prudent cost avoidance efforts by working in conjunction with Operating District in several different aspects of the project – planning and design, construction, and the overall scope change from hydrotest to replacement, abandonment and derate.

End of Supply Line 41-17 Replacement Final Report

Pipeline Safety Enhancement Plan Final Report
Supply Line 41-116 Replacement Project

I. SUPPLY LINE 41-116 REPLACEMENT PROJECT

A. Background and Summary

Supply Line 41-116 is a [REDACTED] diameter inlet line that runs approximately 55 feet within SoCalGas and SDG&E's Magnolia Avenue Regulator and Meter Station surrounded by both residential and commercial properties. The pipeline is primarily routed across a Class 3 location. Although Supply Line was identified on the initial PSEP filing, it was agreed that the Operating District would complete engineering and design for the project, along with the replacement of PSEP sections. This report describes the activities associated with Supply Line 41-116 Replacement Project that consists of the replacement of 49 feet of pipeline from within the regulator and meter station to the inlet of an adjoining transmission Line 2000. The specific attributes of this Project are detailed in Table1 below. The total loaded cost of the Project is \$226,755.

Pipeline Safety Enhancement Plan Final Report Supply Line 41-116 Replacement Project

Table 1: General Project Information

Project Name	Supply Line 41-116		
Project Type	Replacement		
Length	49 feet		
Location	Riverside		
Class	3		
MAOP (<i>confidential</i>)	[REDACTED]		
Pipe Vintage	1957		
Construction Start	10/08/2016		
Construction Finish	11/08/2016		
Original Pipe Diameter (<i>confidential</i>)	[REDACTED]		
New Diameter (<i>confidential</i>)	[REDACTED]		
Original SMYS ¹ (<i>confidential</i>)	[REDACTED]		
New SMYS (<i>confidential</i>)	[REDACTED]		
Project Costs (\$)	Capital	O&M	Total
Loaded Project Costs	226,755	-	226,755
Disallowed Costs	-	-	-

¹ Highest percentage of Specified Minimum Yield Strength (SMYS) of Category 4 Criteria pipe.

Pipeline Safety Enhancement Plan Final Report
Supply Line 41-116 Replacement Project

B. Maps and Images

Figure 1: Satellite Image of Supply Line 41-116 Replacement Project



Pipeline Safety Enhancement Plan Final Report Supply Line 41-116 Replacement Project

Figure 2: Overview Map of Supply Line 41-116 Replacement Project

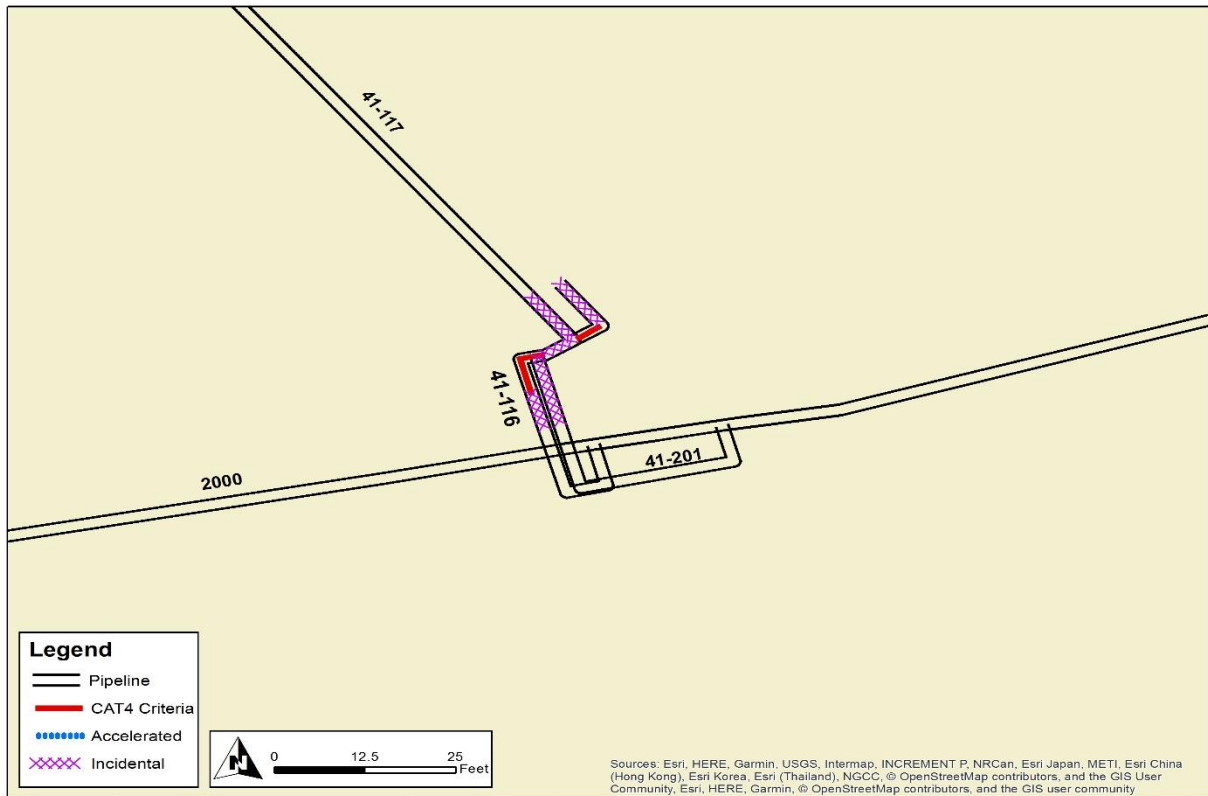

Pipeline Safety Enhancement Plan Final Report
Supply Line 41-116 Replacement Project

II. ENGINEERING, DESIGN, AND PLANNING

A. Project Scope

Table 2: Mileage Information

	Criteria	Accelerated	Incidental	New	Total ²
Final Mileage	13 ft.	0 ft.	26 ft.	11 ft.	49 ft.

SoCalGas and SDG&E presented a conceptual project scope in workpapers supporting the 2011 PSEP filing.³ Prior to initiating execution of the Project in 2016, SoCalGas and SDG&E reviewed existing pipeline records to validate the scope of the Project. During the Engineering, Design, and Planning phase, SoCalGas and SDG&E further refined the scope. This progression of the project scope is summarized as follows:

1. 2011 PSEP Filing: SoCalGas and SDG&E identified Supply Line 41-116, Supply Line 41-116-BP1, and Supply Line 41-201 as a Phase 1A Replacement Project comprised of 33 feet of Category 4 Criteria pipe and 35 feet of Accelerated pipe.
2. Scope Validation: Through scope validation activities, after the 2011 filing and before initiating execution of the Project, SoCalGas and SDG&E successfully eliminated both Category 4 Criteria pipe and Accelerated pipe for Supply Line 41-201, and reduced the scope of the Project by 17 feet of Category 4 Criteria pipe, and 37 feet of Accelerated pipe.

² Values may not add to total due to rounding.

³ See Amended PSEP of SoCalGas and SDG&E, submitted December 2, 2011, in R.11-02-019 and subsequently transferred to A.11-11-002.

Pipeline Safety Enhancement Plan Final Report
Supply Line 41-116 Replacement Project

3. Engineering, Design, and Constructability: The Project Team initiated communications with stakeholders external to PSEP early on and identified that the PSEP scope could be completed in conjunction with the Operating District's Magnolia Avenue Regulator Station upgrade project. Although Supply Line 41-116 was identified on the initial PSEP filing, it was agreed that the Operating District would complete engineering and design for the project along with replacing the segments of Category 4 Criteria pipe.
4. Final Project Scope: The final project scope consists of a 49 foot Replacement. There was no Accelerated pipe and 26 feet of Incidental pipe.

B. Decision Tree Analysis

SoCalGas and SDG&E performed a PSEP Decision Tree analysis of Supply Line 41-116 and confirmed the project design should commence as a Replacement Project.

Segments of less than 1,000 feet are identified for replacement under the approved PSEP Decision Tree because, for short segments of pipe, the logistical costs associated with pressure testing (for example, permitting, construction, water handling, and service disruptions for a non-looped system) can approach or exceed the cost of replacement. In such circumstances, replacement affords a more cost-effective approach to achieving compliance with D.11-06-017 while providing equal safety enhancement benefits. Moreover, installation of the new segment can usually be performed while the existing service is maintained to customers, thereby avoiding service disruptions that may otherwise occur during pressure testing.

Pipeline Safety Enhancement Plan Final Report
Supply Line 41-116 Replacement Project

C. Engineering, Design, and Planning Factors

SoCalGas and SDG&E reviewed pipeline drawings and other information, contacted internal planning groups, communicated with external stakeholders, conducted survey activities, including reviewing public records of the area to confirm the presence of underground utilities and substructures, and completed a pre-design site walk. Key factors that included the engineering and design of the Project are as follows:

1. Schedule Coordination: As discussed above, the Project Team initiated communications with stakeholders external to PSEP early on, and identified that the PSEP scope could be completed in conjunction with the Operating District's Magnolia Avenue Regulator Station upgrade project. Due to Supply Line 41-116 being identified on the initial PSEP filing, it was agreed that the Operating District and PSEP would collaborate engineering and design in an effort to eliminate duplicative and redundant work. Execution by the Operating District with PSEP oversight would be more efficient and cost effective.
2. Land Use: The Project was completed within SoCalGas and SDG&E's Magnolia Avenue Regulator and Meter Station.
3. Shut-In Analysis: The Project Team completed a Request for Engineering Review (RER) analysis and concluded that the station could be shut-in during summer conditions, and that station upgrades would not be required as originally recommended.
4. Permit Conditions: No permits were required since the Project was within SoCalGas and SDG&E property.

Pipeline Safety Enhancement Plan Final Report Supply Line 41-116 Replacement Project

Figure 3: Supply Line 41-116 Replacement Project Schematic

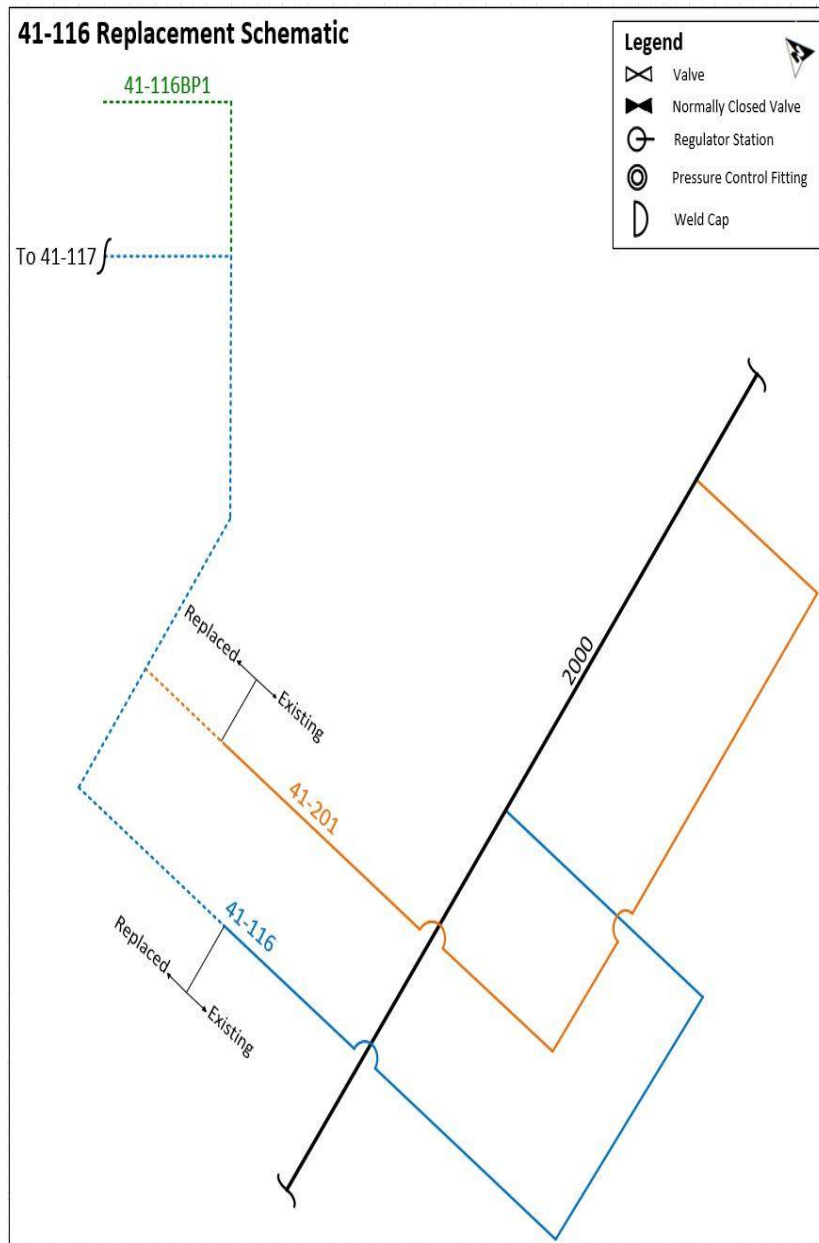

Pipeline Safety Enhancement Plan Final Report
Supply Line 41-116 Replacement Project

D. Scope Changes

Through engineering, design, and planning activities, SoCalGas and SDG&E determined that changes in scope were appropriate to enhance the design of the Project and address engineering factors. These changes in scope did not impact the preliminary cost estimate. The notable change in scope, made after the preliminary cost estimate was developed and approved, was the descoping of Supply Line 41-116-BP1 and Supply Line 41-201 from this project due to the elimination of Category 4 Criteria pipe and Accelerated pipe. The Operating District removed Supply Line 41-116-BP1 and Supply Line 41-201 from the engineering and drawing package. SoCalGas and SDG&E decided to have the Operating District continue with the Line 41-116 portion of the station project that addressed the PSEP segments of Category 4 Criteria pipe.

Pipeline Safety Enhancement Plan Final Report
Supply Line 41-116 Replacement Project

III. CONSTRUCTION

A. Construction Contractor Selection

SoCalGas and SDG&E’s Distribution Organization selected a contractor from a competitively bid Master Service Agreement (MSA) to perform the specified work.

1. SoCalGas and SDG&E’s Preliminary Construction Cost Estimate (confidential):
SoCalGas and SDG&E’s preliminary cost estimate for construction was [REDACTED].
2. Construction Contractor’s Price Estimate: There was no Construction Contractor cost estimate for this project as it was completed on a Time and Expense basis.

B. Construction Schedule

Table 3: Construction Timeline

Construction Start Date	10/08/2016
Construction Completion Date	11/08/2016
NOP Date	11/08/2016

C. Changes During Construction

There were no conditions that were raised by the SoCalGas and SDG&E’s Distribution Organization that resulted in notable change orders.

Pipeline Safety Enhancement Plan Final Report
Supply Line 41-116 Replacement Project

D. Commissioning and Site Restoration

Commissioning activities include restoration of the site, final inspection and placement of the pipeline back into service, transportation and disposal of hydrotested water and hazardous material, and site demobilization. Closeout activities include development of final drawings, finalization of a reconciliation package, and updates to company recordkeeping systems to reflect the completed scope of work.

Pipeline Safety Enhancement Plan Final Report
Supply Line 41-116 Replacement Project

IV. PROJECT COSTS

A. Cost Avoidance Actions

SoCalGas and SDG&E exercised due diligence in the planning, design, and construction activities for this project to minimize or avoid costs when prudent to do so. As discussed above, the Project Team conducted a site visit to identify and incorporate discernible site conditions into the engineering, design, and planning of the Project. A specific example of a cost avoidance action taken on this project is:

1. Engineering and Design: The Project eliminated the Category 4 Criteria pipe and Accelerated pipe for Supply Line 41-201, that led to a scope reduction.

B. Cost Estimate

Based on the preliminary design, once the project scope was confirmed and engineering, design, and planning activities were underway, SoCalGas and SDG&E prepared an estimate of the Direct Costs of the Project in the amount of \$194,612. The estimate was prepared using the SoCalGas and SDG&E Distribution Operating District's Construction Management System (CMS). The planner representing the operating district considered the conditions known at the time to prepare the preliminary Direct Cost estimate. This estimate reflects the projected Labor, Material, and Services costs anticipated to be incurred to execute the Project.

SoCalGas and SDG&E estimated Indirect Costs of the Project based on the estimated Direct Costs and other project related variables.

Pipeline Safety Enhancement Plan Final Report
Supply Line 41-116 Replacement Project

C. Actual Direct and Indirect Costs

Actual Direct Costs reflect the Labor, Material, and Service costs incurred to execute the Project. Actual Indirect Costs reflect costs for incremental overhead loaders in accordance with Company overhead allocation policies. The total loaded cost of the Project is \$226,755.

Table 4: Estimated and Actual Direct Costs and Variances

Direct Costs (\$)	Estimate	Actuals ⁴	Delta Over/(Under)
Company Labor	48,621	11,936	(36,685)
Materials	12,427	144,153	131,726
Construction Contractor	106,563	-	(106,563)
Construction Management & Support	7,000	2,598	(4,402)
Environmental	0	2,232	2,232
Engineering & Design	20,001	9,506	(10,495)
Project Management & Services	-	450	450
ROW & Permits	-	-	-
GMA	-	26,745	26,745
Total Direct Costs	194,612	197,620	3,008

⁴ Actual Material and Construction Contractor costs exclude the cost of upsizing the pipe.

Pipeline Safety Enhancement Plan Final Report
Supply Line 41-116 Replacement Project

Table 5: Estimated and Actual Indirect Costs, Total Costs, and Variances

Indirect Costs/Total Costs (\$)	Estimate	Actuals	Delta Over/(Under)
Overheads	36,805	27,910	(8,895)
AFUDC	50,301	384	(49,917)
Property Taxes	10,482	841	(9,641)
Total Indirect Costs	97,588	29,135	(68,453)
Total Direct Costs	194,612	197,620	3,008
Total Loaded Costs	292,200	226,755	(65,445)

D. Disallowance

There was no disallowance for Supply Line 41-116 as there were no post-1955 segments included in the Project without records that provide the minimum information to demonstrate compliance with then applicable industry standards or regulatory strength testing and recordkeeping requirements.

Pipeline Safety Enhancement Plan Final Report
Supply Line 41-116 Replacement Project

V. CONCLUSION

SoCalGas and SDG&E enhanced the safety of their integrated natural gas transmission system by prudently executing the Supply Line 41-116 Replacement Project. Through this Replacement Project, SoCalGas and SDG&E successfully addressed the Category 4 Criteria segments in the City of Riverside. The total loaded cost of the Project is \$226,755.

SoCalGas and SDG&E executed this project prudently through completing planning and design in conjunction with the Operating District, eliminating the potential for duplicative and redundant work.

SoCalGas and SDG&E engaged in prudent cost avoidance efforts by working in conjunction with Operating District in several different aspects of the project planning and design, construction, and the overall scope reduction by eliminating Supply Line 41-116-BP1 and Supply Line 41-201.

Pipeline Safety Enhancement Plan Final Report for
Supply Line 41-6000-2 Replacement Project

I. SUPPLY LINE 41-6000-2 REPLACEMENT PROJECT¹

A. Background and Summary

Supply Line 41-6000-2 is a predominantly [REDACTED] diameter transmission line located just east of the Salton Sea in the City of Calipatria that runs to the Mexico border. The pipeline is primarily routed across a Class 1 location that traverses over flat terrain, through farmland, expansive networks of irrigation, drainage canals, along with cattle, dairy and feed lots. This report describes the activities associated with the Supply Line 41-6000-2 Replacement Project, which includes the installation of 11.741 miles of new pipeline to the north of Line 6914 to allow for the planned abandonment of Supply Line 41-6000-2². This 11.741 mile installation to the north extends Line 6914 and is now known as Line 6921. The specific attributes of this Project are detailed in Table 1 below. The total loaded cost for this project is \$84,857,381.

This project extends existing Line 6914 northwards and installs piping for two crossover stations at Young Station and Dowden Station. The installation must be fully operational before Supply Line 41-6000-2 can be abandoned in order to maintain service to the southern portion of the system. The original work plan was to abandon and replace 26 miles of Line 41-6000-2 (located several miles south of Line 6914), but through initial engineering, design and planning activities, SoCalgas and SDG&E determined that isolating Line 41-6000-2 to abandon the segment, would detrimentally impact system capacity to the extent that reliable service to customers could not be maintained.

¹ In the monthly CPUC report this project is listed as 6914.

² Supply Line 41-6000-2 Abandonment Project is scheduled to complete construction in the first quarter of 2019.

Pipeline Safety Enhancement Plan Final Report for
Supply Line 41-6000-2 Replacement Project

The estimated cost to replace and abandon Line 41-6000-2 exceeded the estimated cost to extend Line 6914 to the north and abandon Line 41-6000-2. Moreover, the extension of Line 6914 provides overall, improved system capacity and was specifically proposed in SoCalGas and SDG&E A.11-11-002.³

³ A.11-11-002, SoCalGas and SDG&E Rebuttal Testimony of David Bisi Chapter 10 at pp. 1-2 (“SoCalGas and SDG&E propose to abandon 36 miles of Line 41-6000-2, and replace its functionality with a new [REDACTED] diameter, 11-mile extension of existing Line 6914. Another 2.5 miles of [REDACTED] diameter pipeline will extend from the existing Line 6914 to the distribution system south of El Centro, and the remaining 13 miles of smaller diameter pipeline are necessary to tie the distribution system that is currently supplied by Line 41-6000-2 into Line 6914.”)

Pipeline Safety Enhancement Plan Final Report for
Supply Line 41-6000-2 Replacement Project

Table 1: General Project Information

Project Name	Supply Line 41-6000-2 Replacement Project (New Line 6921)		
Project Type	Replacement		
Length	11.741 miles		
Class	1		
Location	City of Calipatria, City of Niland (Imperial County)		
MAOP (Supply Line 41-6000-2) (<i>confidential</i>)	[REDACTED]		
MAOP (Line 6921) (<i>confidential</i>)	[REDACTED]		
Pipe Vintage (SL 41-6000-2)	1948		
Construction Start	09/08/2015		
Construction Finish	11/23/2016		
Original Pipe Diameter (<i>confidential</i>)	[REDACTED]		
New Diameter (<i>confidential</i>)	[REDACTED]		
Original SMYS ⁴ (Supply Line 41-6000-2) (<i>confidential</i>)	[REDACTED]		
New SMYS (Line 6921) (<i>confidential</i>)	[REDACTED]		
Project Costs (\$)	Capital	O&M	Total
Loaded Project Costs	84,857,381	-	84,857,381
Disallowed Costs	-	-	-

⁴ Highest percentage of Specified Minimum Yield Strength (SMYS) of Category 4 Criteria pipe.

Pipeline Safety Enhancement Plan Final Report for
Supply Line 41-6000-2 Replacement Project

B. Maps and Images

Figure 1: Satellite Image of Line 6914

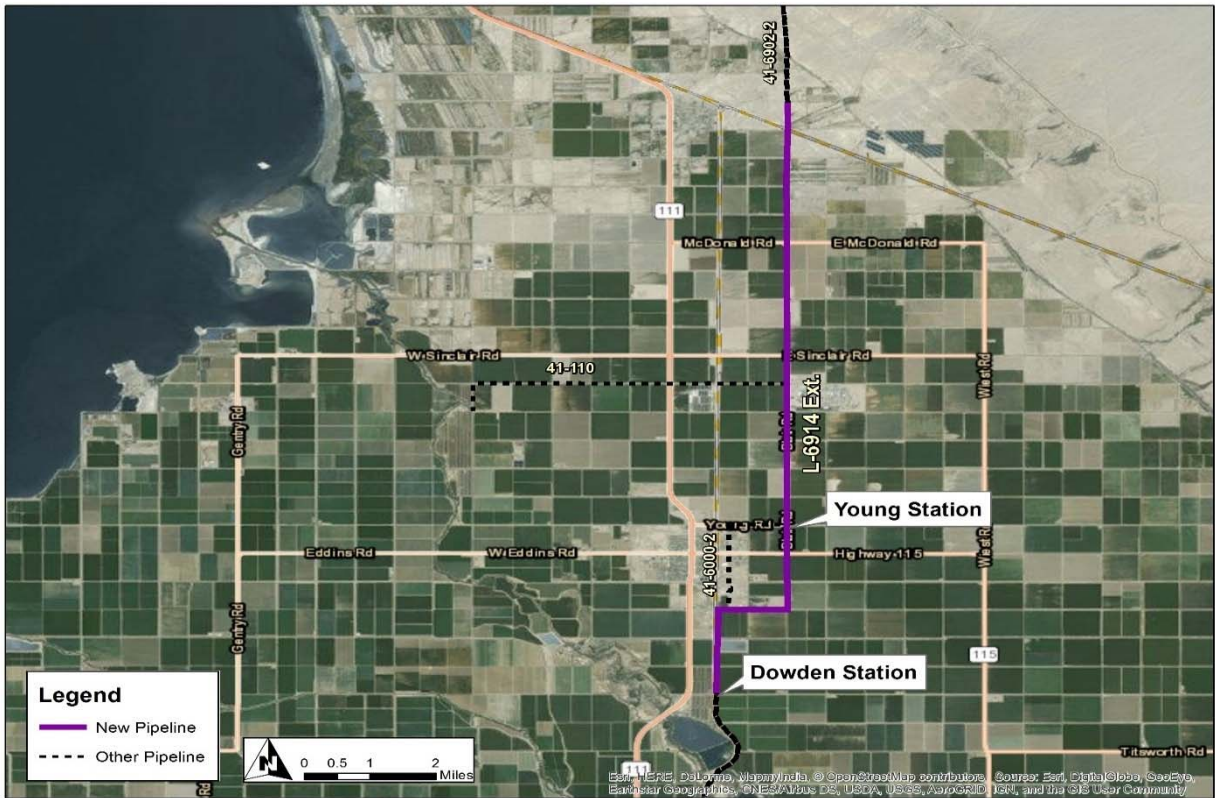

Pipeline Safety Enhancement Plan Final Report for
 Supply Line 41-6000-2 Replacement Project

Figure 2: Overview Map of Line 6914



Pipeline Safety Enhancement Plan Final Report for Supply Line 41-6000-2 Replacement Project

Figure 3: Crossover Schematic of Supply Line 41-6000-2 Replacement Project

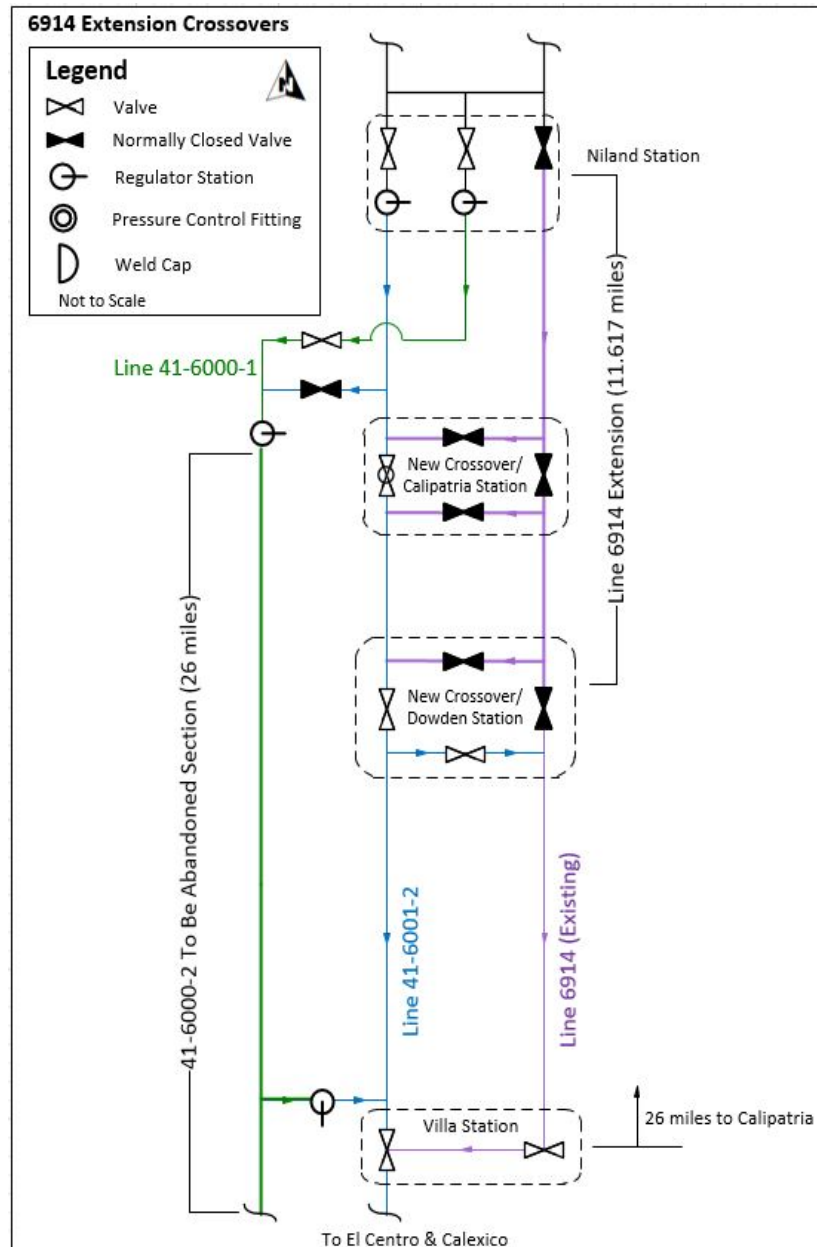

Pipeline Safety Enhancement Plan Final Report for
Supply Line 41-6000-2 Replacement Project

II. ENGINEERING, DESIGN, AND PLANNING

A. Project Scope

Table 2: Mileage Information

	Criteria	Accelerated ⁵	Incidental	New	Total ⁶
Final Mileage	0 mi.	0.063 mi.	0.021 mi.	11.657 mi.	11.741 mi.
	0 ft.	332 ft.	113 ft.	61,547 ft.	61,993 ft.

SoCalGas and SDG&E presented a conceptual project scope in workpapers supporting the 2011 PSEP filing⁷ for Line 41-6000-2. Prior to initiating execution of the Project in 2015, SoCalGas and SDG&E reviewed existing pipeline records to validate the scope of the project. During the Engineering, Design and Planning phase, SoCalGas and SDG&E further refined the scope. The progression of the project scope is summarized as follows:

1. 2011 PSEP Filing: SoCalGas and SDG&E identified Line 41-6000-2 as a Phase 1A replacement project comprised of 11.373 Category 4 Criteria miles and 24.577 Accelerated miles, for a total of 35.950 miles. The cost estimate included the extension of existing Line 6914 in conjunction with the abandonment of Line 41-6000-2 to mitigate detrimental impacts to system capacity.

⁵ Accelerated mileage includes Phase 2B pipe. Phase 2B includes pipelines without record of a pressure test to modern – Subpart J – standards (Phase 2B). The Accelerated mileage was included to realize efficiencies and to enhance project constructability.

⁶ Values may not add to total due to rounding.

⁷ See Amended PSEP of SoCalGas and SDG&E, submitted December 2, 2011, in R.11-02-019 and subsequently transferred to A.11-11-002.

Pipeline Safety Enhancement Plan Final Report for
Supply Line 41-6000-2 Replacement Project

2. Scope Validation: Through scope validation activities, after the 2011 filing and before initiating execution of the Project, SoCalGas and SDG&E confirmed that the installation of the Line 6914 extension had to be completed before the abandonment of Line 41-6000-2 could begin, due to system capacity limitations and anticipated customer impacts.
3. Engineering, Design, and Constructability: Based on the alternative designs described below, the Project Team determined that the best option for this project was to install a new extension to the north of existing Line 6914.
4. Alternative Designs: In evaluating Line 41-6000-2, the Project Team considered three options:
 - a. The Project Team considered hydrotesting, but did not select this option, as the line could not be taken out of service with manageable customer impacts due to the existence of nine regulator stations on this line.
 - b. The Project Team also considered replacing the line. While there were only five miles of pipe to be addressed in Phase 1A, the balance of 20 miles of pipe would need to be addressed in Phase 2. Rather than replace five miles of pipe in Phase 1 and then replace the remaining 20 miles three to four years later, the Project Team reviewed the entire system and developed the selected alternative (listed below) as the most cost effective safety enhancement design. The construction duration of this option would have been much longer than the selected option, with further increased the estimated costs of this option.
 - c. The Project Team made the final decision to install the extension of Line 6914, as it was more cost efficient and improved overall system capacity, with manageable customer impacts.

Pipeline Safety Enhancement Plan Final Report for
Supply Line 41-6000-2 Replacement Project

5. Final Project Scope: The final project scope consists of installation of 11.741 miles of new [REDACTED] pipe, one mainline valve (MLV) and 22 jack-and-bore crossings under irrigation canals or drainage crossings.

B. Decision Tree Analysis

As described above, during the Decision Tree analysis for Line 41-6000-2, SoCalGas and SDG&E concluded that abandonment of Line 41-6000-2⁸ and an 11.741 mile extension of Line 6914, rather than the replacement of Line 41-6000-2, would be more cost efficient, and also improve overall system capacity.

C. Engineering, Design, and Planning Factors

SoCalGas and SDG&E reviewed pipeline drawings and other information, contacted internal planning groups, communicated with external stakeholders, conducted survey activities, including reviewing public records, utilizing ground penetrating radar technology, and potholing of the area to confirm the presence of underground utilities and substructures, and completed a pre-design site walk. Key factors that influenced the engineering and design of the Project are as follows:

1. Shut-In Analysis: SoCalGas and SDG&E completed a shut-in analysis and determined that parallel Lines 41-6001-2 and 41-6000-1 can be isolated in order to complete the crossover tie-ins.
2. Site Observations:
 - a. Several farm irrigation and drainage canals cross along the pipe alignment, presenting a potential requirement for casing and/or deep horizontal directional drilling (HDD) or jack-and-bore installations.

⁸ The Line 41-6000-2 Abandonment Project will be submitted for reasonableness review in a future filing.

Pipeline Safety Enhancement Plan Final Report for
Supply Line 41-6000-2 Replacement Project

- b. Land Acquisitions required to expand Niland Station, Calipatria Station, and Dowden/Kershaw Station.
 - c. Necessary rights-of-way (ROW) acquisitions required from a private entity and Los Angeles Department of Water and Power (LADWP) for the northern most portion of project.
 - d. Flooded farm fields may potentially impact ground water level.
 - e. Indications of burrowing owl nesting sites along the pipe alignment.
3. Customer Impact: To facilitate crossover tie-ins, the Project Team had to shut-in parallel Lines 41-6001-2 and 41-6000-1. Most of the customers and regulator stations on these lines had dual taps or feeds, so there was little to no anticipated impact. There was impact to some of the electric generation (EG) loads (power plants) downstream of the system, but the Project Team minimized this by coordinating with planned EG outages.
4. Known Substructures: Prior to construction, the Project Team utilized ground penetrating radar to confirm optimal pipeline alignment and ensure that there were no major conflicts with underground structures. Results did not impact engineering design. The Project Team performed potholing during construction to verify these findings.
5. Permit Restrictions: The Project Team anticipated delays for Caltrans and Union Pacific Railroad (UPRR) crossings; however, both permits were received in time for construction.
6. Traffic Control: County permits would not authorize large segments of the roadway to be closed simultaneously, impacting the construction schedule, but did not impact design.

Pipeline Safety Enhancement Plan Final Report for
Supply Line 41-6000-2 Replacement Project

7. Land Use: Land Services was able to obtain easements at a reasonable rate.
8. Environmental: Several work areas contained burrowing owl nesting habitats. In preparation for this, PSEP planned for environmental monitors to be on site.
9. Valves: The Project Team installed one new MLV, and crossover piping and tap valves for the two new crossover stations.
10. Bypass: To facilitate crossover tie-ins, the Project Team had to shut-in parallel Lines 41-6001-2 and 41-6001-1. Most of the customers and regulator stations on these lines had dual taps or feeds so there was little to no anticipated impact.

D. Scope Changes

SoCalGas and SDG&E did not make any notable scope changes during detailed design.

Pipeline Safety Enhancement Plan Final Report for
Supply Line 41-6000-2 Replacement Project

III. CONSTRUCTION

A. Construction Contractor Selection

The Project Team prepared an initial cost estimate based on the preliminary design. Following completion of the engineering, design, and planning activities described above, SoCalGas and SDG&E entered into a competitive bidding process to select a construction contractor. SoCalGas and SDG&E awarded the construction contract to the bidder that best met the selection criteria for this project.

1. SoCalGas and SDG&E’s Preliminary Construction Cost Estimate (confidential):
SoCalGas and SDG&E’s preliminary cost estimate for construction was [REDACTED].
2. Construction Contractor’s Bid (confidential): The Construction Contractor’s Bid was [REDACTED], which was [REDACTED] than SoCalGas and SDG&E’s preliminary cost estimate for construction.

B. Construction Schedule

Table 3: Construction Timeline

Construction Start Date	09/08/2015
Construction Completion Date	11/23/2016
NOP Date	05/27/2016

C. Changes During Construction

The conditions summarized below were encountered during construction. Activities to address or mitigate these conditions resulted in approximately \$11,400,000 in change orders.

1. Site Conditions: The Construction Contractor did not anticipate needing additional shoring for deeper bore pit depths at jack-and-bore crossings during the planning

Pipeline Safety Enhancement Plan Final Report for
Supply Line 41-6000-2 Replacement Project

and design phase, but they were required by the Imperial Irrigation District (IID) permit, which was obtained after bidding and contractor selection. A permit agency provided a late, unanticipated requirement that the pipeline be placed underneath all irrigation facilities rather than crossover the top. This necessitated deeper, longer bores and significant dewatering efforts. These efforts added 35 days to the overall construction schedule.

2. Soil Conditions: The Project Team encountered soft soil conditions at three locations that required additional slope excavations to prevent cave-ins, ensure a safe working environment, and zero sack slurry as backfill. These activities did not impact the schedule.
3. Permit Conditions:
 - a. Additional requirements the Project Team did not plan for but that Imperial County required added 24 days to the schedule. These are as follows:
 - i. Requirement for two sack slurry backfill on all non-paved roads;
 - ii. Compaction testing of existing paving sub-base; and
 - iii. The county allowed limited road closures; however, it did not allow simultaneous road closures.
 - b. In addition, the county imposed unanticipated land restoration (paving) activities due to the minimal thickness and poor condition of the exiting paving.
4. Environmental: Although the Project Team planned for biological monitors during the planning and design phase, additional biological monitors and sound and visual barriers were required for burrowing owl nesting habitats. This did not impact the schedule. Additional Best Management Practices (BMPs) were also required to supplement what the Project Team originally proposed in the Storm Water Pollution Prevent Plan (SWPPP).

Pipeline Safety Enhancement Plan Final Report for
Supply Line 41-6000-2 Replacement Project

5. Access: The Project Team encountered delays in receiving an executed land agreement, which added seven days to the schedule.
6. Weather: Heavy rainfall encountered in early January 2016 delayed work by three days due to slippery site conditions.
7. Environmental Abatement: During hydro excavating activities dark material appeared. As a precaution, the Project Team assumed that the material could have the potential to contain asbestos. The Project Team put work on hold and collected soil samples for testing. Results returned negative, and work resumed. The construction crew was on standby for one day and a hydrovac truck was brought in to collect the soil samples.
8. Schedule Delay: The following factors delayed construction start:
 - a. The Project Team assumed a 30-day Pipeline and Hazardous Materials Administration (PHMSA) notification, versus a 60-day notification, which pushed the construction start date by one month.
 - b. The Project Team did not complete land acquisition for the north end of the Project by the anticipated construction start date. At that point, the team decided to separate the Project into two sections, to begin mobilization and construction at the southern end as soon as practicable.
9. Substructures: The Construction Contractor encountered the following substructure issues during construction:
 - a. During bore operations, an auger encountered an obstruction impeding bore operations for over two days. The pilot drill struck an unknown obstruction impeding bore operations. The Construction Contractor then excavated the bore pits to a greater depth of 28 feet in hopes of being able to complete boring operations underneath the obstruction. The bore then struck another obstruction.

Pipeline Safety Enhancement Plan Final Report for
Supply Line 41-6000-2 Replacement Project

The Construction Contractor and IID then decided to open trench and lay pipe over their existing facilities.

- b. The Construction Contractor struck and damaged an unmarked clay drain line from a farmer's field during this excavation. The Project Team uncovered and repaired the pipe.
 - c. At Young Station, the Construction Contractor identified a drain line that interfered with the alignment of the new crossover station. The Project Team relocated the drain line.
 - d. During the excavation of bore pits, the Project Team determined that the room between the shoring boxes and the existing gas lines was insufficient. To remediate the issue, the team moved the shoring box located at Sinclair Road 130 feet to the south and shifted the shoring box at Hooper Road 85 feet to the south.
 - e. The Project Team identified an unmarked water line after the start of excavation work, and this required a change from the original pipeline alignment.
 - f. The Project Team identified a large concrete slab during excavation activities at the Dowden Station. Due to its proximity to live gas lines, the slab had to be demolished and removed by hand.
 - g. Several jack-and-bore locations along the line paralleled active, high pressure pipelines that needed to be exposed (for safety reasons) prior to drilling dewatering wells.
10. Tie-In: The Project Team completed several tie-ins for the entire project, both hot and cold. For the final tie-in, the Project Team installed a pressure control valve downstream of the MLV to fully isolate the pipeline after it was determined that the existing valve would not provide the necessary gas isolation for the required work.

Pipeline Safety Enhancement Plan Final Report for
Supply Line 41-6000-2 Replacement Project

The final crossover tie-in was delayed until November 2016 as anticipated system demands would not allow the line to be shutdown during the peak summer period. The team demobilized and remobilized the Project.

11. Utility Coordination: The Project Team brought in temporary city power for the construction trailer yard for the Project and disconnected or de-energized overhead power lines at some work sites to allow for safer construction activities.

Pipeline Safety Enhancement Plan Final Report for
Supply Line 41-6000-2 Replacement Project

Figure 4: Excavation of Bore Pit

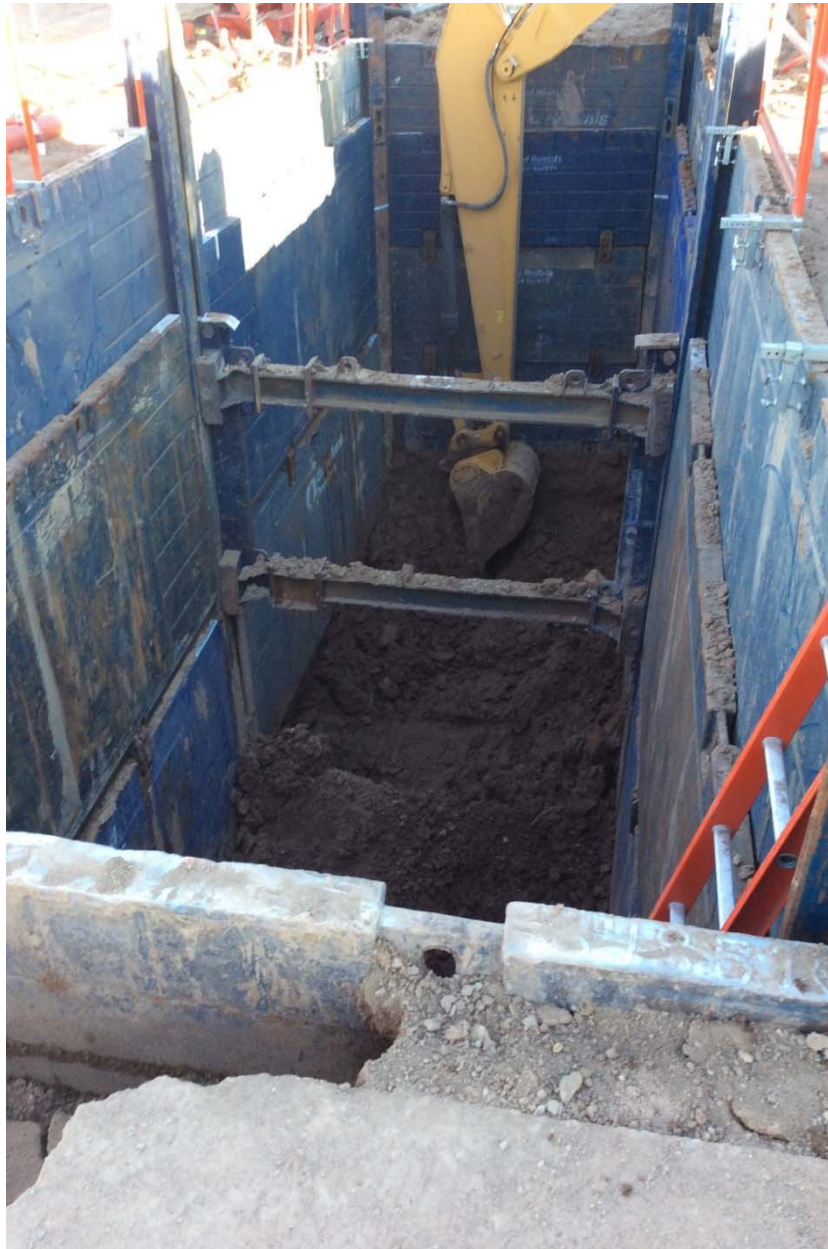

Pipeline Safety Enhancement Plan Final Report for
Supply Line 41-6000-2 Replacement Project

Figure 5: Boring Machine with Dewatering Tank

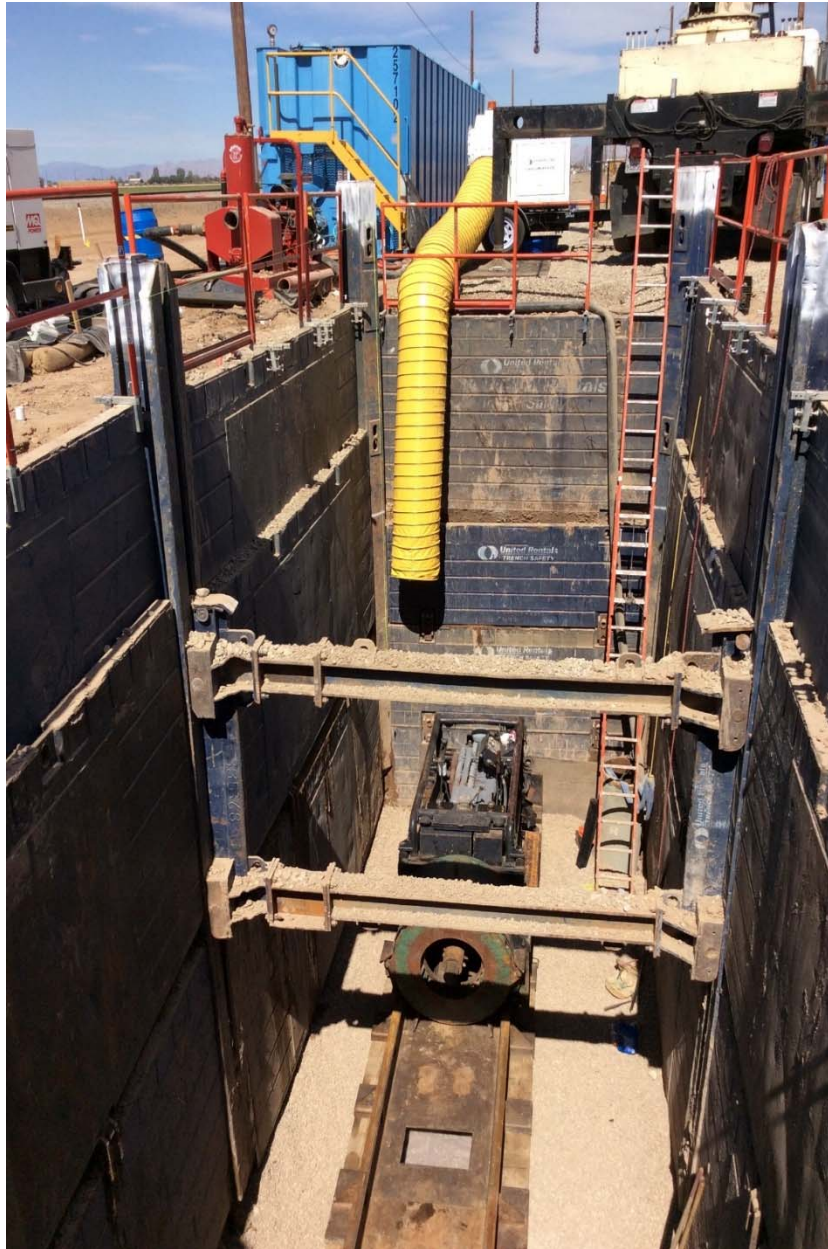

Pipeline Safety Enhancement Plan Final Report for
Supply Line 41-6000-2 Replacement Project

Figure 6: Boring Machine Pushing [REDACTED] Abrasive Resistance Overcoat Pipe



Pipeline Safety Enhancement Plan Final Report for
Supply Line 41-6000-2 Replacement Project

Figure 7: Pipe Tie-in Complete and Preparation of Bore Pit for Backfill



Pipeline Safety Enhancement Plan Final Report for
Supply Line 41-6000-2 Replacement Project

D. Commissioning and Site Restoration

Commissioning activities include restoration of the site, final inspection and placement of the pipeline into service, transportation and disposal of any hazardous material and site demobilization. The hydrotested water was treated and gifted to the Calipatria State Prison.

Closeout activities include development of final as-built drawings, the reconciliation package, and updates to company recordkeeping systems to reflect the completed scope of work, which included naming this 11.741 mile pipe Line 6921.

Pipeline Safety Enhancement Plan Final Report for
Supply Line 41-6000-2 Replacement Project

IV. PROJECT COSTS

A. Cost Avoidance Actions

SoCalGas and SDG&E exercised due diligence in the planning, design, and construction activities for this project to minimize or avoid costs when prudent to do so. As discussed above, the Project Team conducted a site visit to identify and incorporate discernible site conditions into the engineering, design and planning of the Project. Specific examples of cost avoidance actions taken on this project are:

1. Materials: SoCalGas and SDG&E purchased pipe and standard fittings in bulk.
2. Land Use: SoCalGas and SDG&E were successfully obtained easements at a favorable rate.
3. Water Management: One lake tank was utilized in lieu of multiple water storage tanks.

B. Cost Estimates

Based on the preliminary design, once the project scope was confirmed and engineering, design and planning activities were underway, SoCalGas and SDG&E prepared an estimate of the Direct Costs of the Project in the amount of \$75,426,005. This estimate was prepared in December of 2014, using the “SCG Pipeline Estimate Template Rev 1” estimating tool, the most current version of the PSEP Estimate Template at the time. The Project Team considered the conditions known at the time to prepare the preliminary Direct Cost estimate. This estimate reflects the projected Labor, Material, and Services costs anticipated to be incurred to execute the Project.

SoCalGas and SDG&E estimated Indirect Costs of the Project based on the estimated Direct Costs and other project-related variables.

Pipeline Safety Enhancement Plan Final Report for
Supply Line 41-6000-2 Replacement Project

C. Actual Direct and Indirect Costs

Actual Direct Costs reflect the Labor, Material, and Service costs incurred to execute the Project. Actual Indirect Costs reflect costs for incremental overhead loaders in accordance with Company overhead allocation policies. The total loaded cost of the Project is \$84,857,381.

Table 4: Estimated and Actual Direct Costs and Variances

Direct Costs (\$)	Estimate	Actuals	Delta Over/(Under)
Company Labor	1,221,000	1,323,552	102,552
Materials	13,268,107	5,770,905	(7,497,202)
Construction Contractor	39,649,036	39,735,008	85,972
Construction Management & Support	923,628	5,889,066	4,965,438
Environmental	3,908,520	6,443,198	2,534,678
Engineering & Design	4,966,460	6,079,639	1,113,179
Project Management & Services	2,381,100	1,786,327	(594,773)
ROW & Permits	1,136,300	637,844	(498,456)
GMA	7,971,854	8,811,855	840,001
Total Direct Costs	75,426,005	76,477,394	1,051,389

Table 5: Estimated and Actual Indirect Costs, Total Costs, and Variances

Indirect Costs/Total Costs (\$)	Estimate	Actuals	Delta Over/(Under)
Overheads	7,416,100	5,595,935	(1,820,165)
AFUDC	6,596,312	2,357,832	(4,238,480)
Property Taxes	1,390,095	426,220	(963,875)
Total Indirect Costs	15,402,507	8,379,987	(7,022,520)
Total Direct Costs	75,426,005	76,477,394	1,051,389
Total Loaded Costs	90,828,512	84,857,381	(5,971,131)

Pipeline Safety Enhancement Plan Final Report for
Supply Line 41-6000-2 Replacement Project

D. Disallowance

There is no disallowance calculation for Supply Line 32-21 Section 1, as there were no post-1955 segments included in the Project without records that provide the minimum information to demonstrate compliance with then-applicable industry standards or regulatory strength testing and recordkeeping requirements.

Pipeline Safety Enhancement Plan Final Report for
Supply Line 41-6000-2 Replacement Project

V. CONCLUSION

SoCalGas and SDG&E enhanced the safety of their integrated natural gas transmission system by prudently executing the Supply Line 41-6000-2 Replacement Project.

Through this project, SoCalGas and SDG&E successfully installed 11.741 miles of pipe to enable the future abandonment of Supply Line 41-6000-2. The total loaded cost of the project is \$84,857,381.

SoCalGas and SDG&E engaged in prudent cost avoidance efforts by purchasing pipe via the bulk order program and bidding this project to find a competitive rate for the construction contractor.

SoCalGas and SDG&E executed this project prudently by engaging in scope validation efforts that confirmed the optimal design was to install this new line prior to Line 41-6000-2 being taken out of service and abandoned, by phasing the sequence of work into two phases to allow for mobilizations before all land rights were obtained, and by executing a complicated design using 22 jack-and-bore crossings under irrigation canals or drainage crossings. The Project Team mitigated anticipated customer impacts by coordinating the outage schedule with the local power plant, addressed many unknown and unmarked obstructions, and gifted the treated hydrotest water to the local state prison.

SoCalGas and SDG&E's total loaded project cost of \$84,857,381 is reasonable and should be approved.

End of Supply Line 41-6000-2 Replacement Project Final Report

Pipeline Safety Enhancement Plan Final Report
Supply Line 43-121 North Section 1 Replacement Project

I. SUPPLY LINE 43-121 NORTH SECTION 1 REPLACEMENT PROJECT

A. Background and Summary

Supply Line 43-121 is a [REDACTED] diameter transmission pipeline that runs approximately 15 miles along several major arterial roads, parallels Interstate 405, and runs through highly developed and congested residential and commercial areas in the City of Los Angeles. The pipeline is primarily routed across a Class 3 location and traverses some Class 4, 2, and 1 locations. This report describes the activities associated with the Supply Line 43-121 North Section 1 Replacement Project, that consists of the Replacement of 1.009 miles of pipeline, installation of one new mainline valve (MLV), and installation of a protective slab within the Caltrans right of way (ROW). The specific attributes of this Project are detailed in Table 1 below. Total loaded cost of the Project is \$15,990,508.

Pipeline Safety Enhancement Plan Final Report Supply Line 43-121 North Section 1 Replacement Project

Table 1: General Project Information

Project Name	Supply Line 43-121 North Section 1		
Project Type	Replacement		
Length	1.009 miles		
Location	Los Angeles		
Class	Class 4		
MAOP (<i>confidential</i>)	████████		
Pipe Vintage	1930		
Construction Start	08/01/2016		
Construction Finish	04/27/2017		
Original Pipe Diameter (<i>confidential</i>)	████████		
New Diameter (<i>confidential</i>)	████████		
Original SMYS ¹ (<i>confidential</i>)	██████		
New SMYS (<i>confidential</i>)	██████		
Project Costs (\$)	Capital	O&M	Total
Loaded Project Costs	15,990,508	-	15,990,508
Disallowed Costs	-	-	-

¹ Highest percentage of Specified Minimum Yield Strength (SMYS) of Category 4 Criteria pipe.

Pipeline Safety Enhancement Plan Final Report
Supply Line 43-121 North Section 1 Replacement Project

B. Maps and Images

Figure 1: Overall Map of Supply Line 43-121 North Section 1 and 43-121 South Replacement Projects

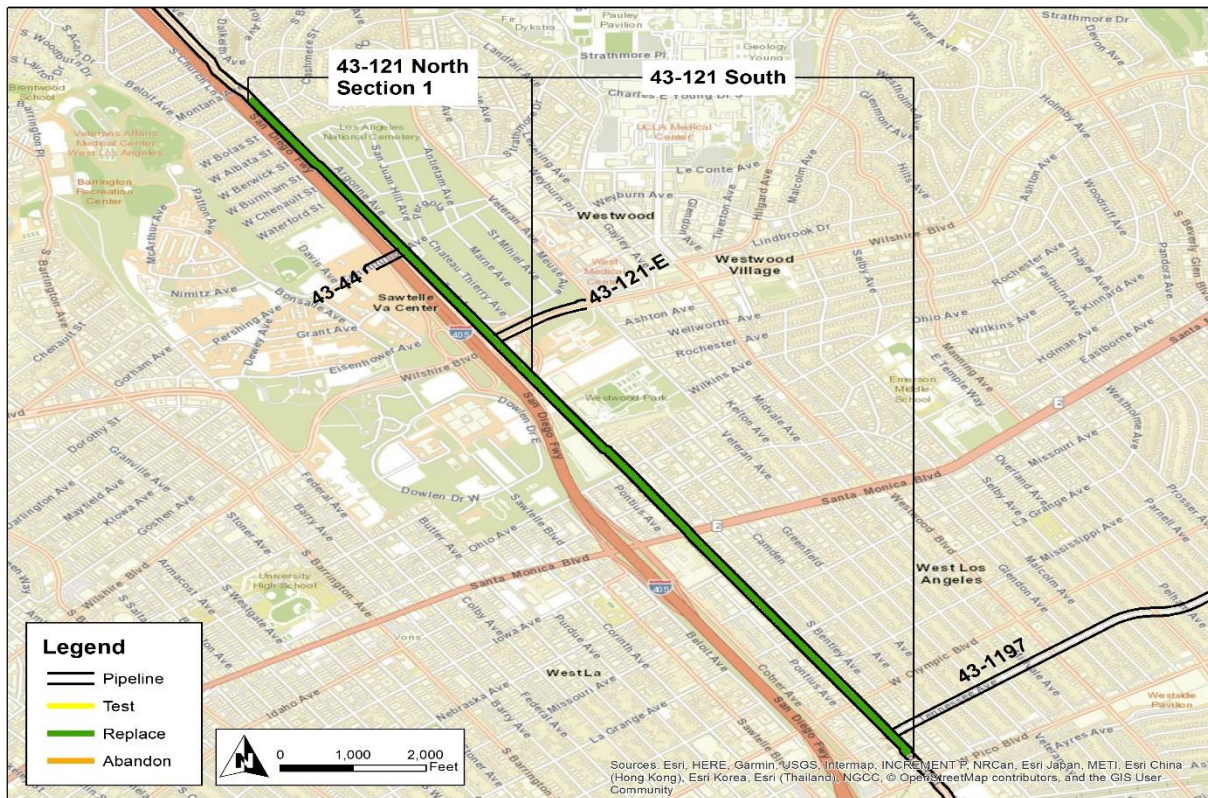

Pipeline Safety Enhancement Plan Final Report Supply Line 43-121 North Section 1 Replacement Project

Figure 2: Satellite Map of Supply Line 43-121 North Section 1 Replacement Project



Pipeline Safety Enhancement Plan Final Report Supply Line 43-121 North Section 1 Replacement Project

Figure 3: Overview Map of Supply Line 43-121 North Section 1 Replacement Project

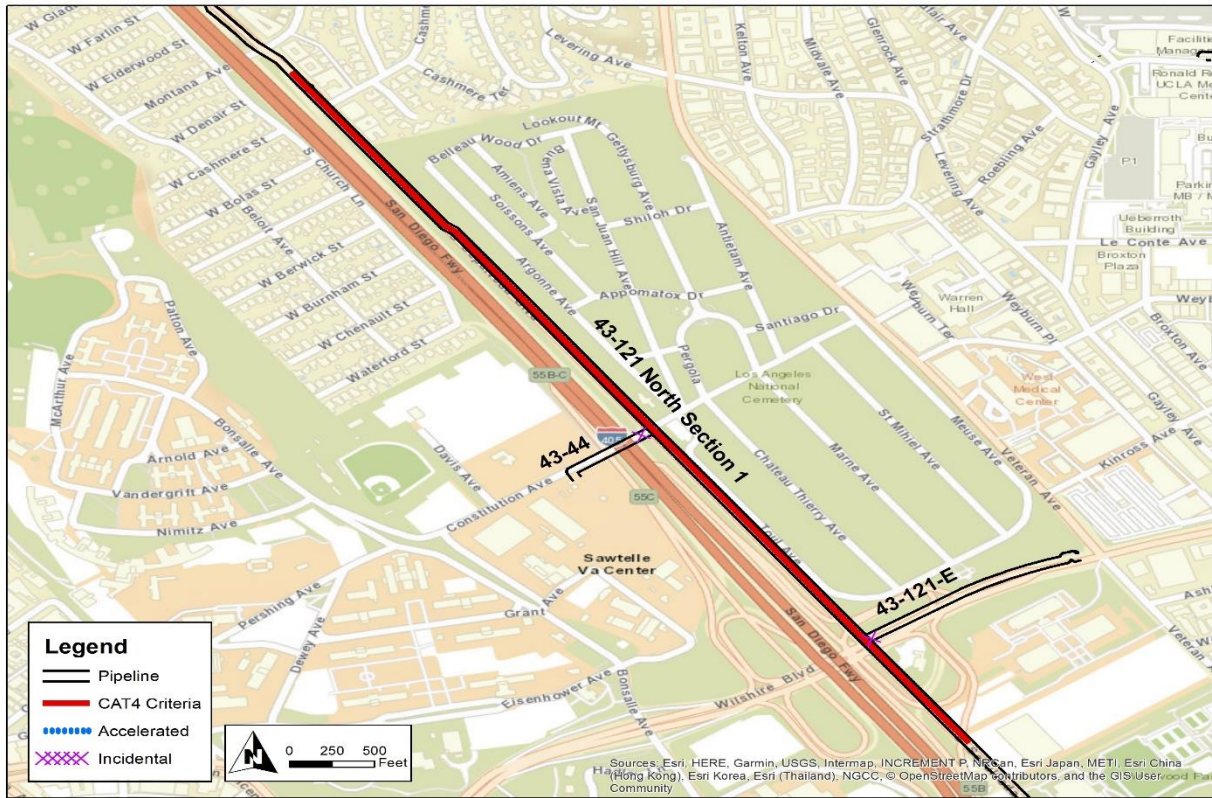

Pipeline Safety Enhancement Plan Final Report
Supply Line 43-121 North Section 1 Replacement Project

II. ENGINEERING, DESIGN, AND PLANNING

A. Project Scope

Table 2: Mileage Information²

	Criteria	Accelerated	Incidental	Total ³
Final Mileage	1.024 mi.	0 mi.	0.001 mi.	1.009 mi.
	5,407 ft.	0 ft.	6 ft.	5,325 ft.

SoCalGas and SDG&E presented a conceptual project scope in workpapers supporting the 2011 PSEP filing.⁴ Prior to initiating execution of the Project in 2016, SoCalGas and SDG&E reviewed existing pipeline records to validate the scope of the Project. During the Engineering, Design, and Planning phase, SoCalGas and SDG&E further refined the scope. This progression of project scope is summarized as follows:

1. 2011 PSEP Filing: SoCalGas and SDG&E identified Supply Line 43-121 as a Phase 1A Replacement Project comprised of 2.766 miles Category 4 Criteria pipe and 1.645 miles of Accelerated pipe.
2. Scope Validation: Through scope validation activities, after the 2011 filing and before initiating execution of the Project, SoCalGas and SDG&E successfully reduced the scope of the Project by 1.742 miles of Category 4 Criteria pipe and removed Accelerated mileage from the project scope.

² Total mileage of the completed project differs from the mileage of the pipe addresses due to realignment of the pipeline route.

³ Values may not add to total due to rounding.

⁴ See Amended PSEP of SoCalGas and SDG&E, submitted December 2, 2011, in R.11-02-019 and subsequently transferred to A.11-11-002.

Pipeline Safety Enhancement Plan Final Report
Supply Line 43-121 North Section 1 Replacement Project

3. Engineering, Design, and Constructability:

- a. To mitigate customer impacts, the Project Team decided to sectionalize the project into two separate replacement projects, Supply Line 43-121 North Replacement Project and Supply Line 43-121 South Replacement Project⁵. The Project Team further separated Supply Line 43-121 North into four sections⁶ to better manage construction efforts.
- b. The Project Team determined that the scope of Supply Line 43-121 North Section 1 Replacement Project consisted of 1.003 miles of Category 4 Criteria pipe and was constructed in two phases.

4. Final Project Scope: The final project scope consists of a 1.009 mile pipeline Replacement and the installation of one new MLV.

B. Decision Tree Analysis

SoCalGas and SDG&E performed a PSEP Decision Tree analysis of Supply Line 43-121 and confirmed the project design should commence as a Replacement project.

Pipeline segments installed prior to 1946 that are not capable of being assessed using in-line inspection technology are identified for replacement under the approved PSEP Decision Tree.

⁵ Supply Line 43-121 South Replacement Project is included in SoCalGas and SDG&E's 2018 Reasonableness Review filing.

⁶ Supply Line 43-121 North Section 2, 3, 4 Replacement Project will be included for reasonableness review in a future filing.

Pipeline Safety Enhancement Plan Final Report
Supply Line 43-121 North Section 1 Replacement Project

As explained in the testimony supporting the approved PSEP, as part of the work previously completed during implementation federal gas transmission pipeline integrity management regulations (49 CFR 192, Subpart O), SoCalGas and SDG&E have already identified, retrofitted and in-line inspected pre-1946 transmission pipelines that were constructed using acceptable welding techniques and are operationally suited to in-line inspection. The remaining pre-1946 segments in the SoCalGas/SDG&E system are not suited for in-line inspection, likely have non-state-of-the-art welds, and would require significant investment for retrofitting to accommodate in-line inspection tools. Accordingly, consistent with the Commission’s directive in D.11-06-017 to “address retrofitting pipeline to allow for inline inspection tools,” the requirement in California Public Utilities Code section 958 that upon completion of the PSEP, where warranted, pipelines are to be capable of accommodating in-line inspection devices, and the overarching objectives of PSEP to enhance the safety of the pipeline system in a proactive, cost effective manner, the approved PSEP Decision Tree identifies pre-1946 non-piggable pipeline segments for abandonment and/or replacement.

Through this Decision Tree analysis, SoCalGas and SDG&E identified replacement as the more prudent option. Key considerations that support SoCalGas and SDG&E’s determination to replace this segment include:

1. Customer Impacts: The Project Team determined that it was not feasible to shut-in customers for the duration of a hydrotest. Major customers on this line include a cogeneration (cogen) plant (that feeds a major university and a hospital), along with Producers.
2. Community Impacts: No identified issues.
3. Permit Conditions: No identified issues.

Pipeline Safety Enhancement Plan Final Report
Supply Line 43-121 North Section 1 Replacement Project

4. Piggability: Non-piggable.
5. Pipe Vintage: 1930.
6. Existing Pipe Attributes: Varying pipe diameters.
7. Longseam Type: Unknown.
8. Longseam Repair History: No identified issues.
9. Condition of Coating: Deteriorating.
10. History of Leaks: No identified issues.

C. Engineering, Design, and Planning Factors

SoCalGas and SDG&E reviewed pipeline drawings and other information, contacted internal planning groups, communicated with external stakeholders, conducted survey activities, including reviewing public records and potholing of the area to confirm the presence of underground utilities and substructures, and completed a pre-design site walk. Key factors that influenced the engineering and design of the Project are as follows:

1. Shut-In Analysis: The Project Team completed a Request for Engineering Review (RER) analysis and concluded that the line could be shut-in provided that customer service would be maintained through alternative means.
2. Customer Impacts:
 - a. Per the RER, there were several customers and Producers that would be affected. The Project Team planned to provide compressed natural gas (CNG) to the customers and coordinate a shut-in with the Producers.

Pipeline Safety Enhancement Plan Final Report
Supply Line 43-121 North Section 1 Replacement Project

- b. The Project Team determined that a shut-in of the cogen plant should be avoided since it serves a hospital and a university and utilized the bridge at the isolation point to maintain feed to the cogen plant.
3. Diameter Changes: The original existing pipeline had a [REDACTED] diameter. SoCalGas and SDGE analyzed typical load demands and future capacity planning for a replacement diameter of [REDACTED] and determined the smaller diameter pipe to be sufficient.
4. Constructability: The Project Team planned to remove and replace the existing pipe in the same alignment except for a small segment of the pipeline that was replaced alongside the existing pipeline.
5. Reroute: Due to the congested nature of Sepulveda Boulevard, the Project Team performed a reroute analysis to study different route options away from Sepulveda Boulevard to avoid removing and replacing the pipe. The Project Team determined that the other options created impacts to the community, traffic, and would result in higher expected costs with no added benefit.
6. Permit Conditions: The Project Team required a Caltrans permit for construction within the Interstate 405 freeway ROW.
7. Schedule Coordination: The Project Team coordinated with other PSEP projects to fully maintain feed and pressure to this portion of the integrated natural gas transmission system.
 - a. The Project Team scheduled the construction of Supply Line 43-121 North Replacement Project following the construction of Supply Line 43-121 South to maintain feed from the south and the north, respectively, during both construction projects.

Pipeline Safety Enhancement Plan Final Report
Supply Line 43-121 North Section 1 Replacement Project

- b. The Project Team coordinated with the tie-in work on Supply Line 37-07 Replacement Project, that had to be completed and in operation before Supply Line 43-121 could be shut-in to maintain pressure. The upsizing of Supply Line 37-07 allowed for increased capacity to the system to meet the demand of isolating Supply Line 43-121.
8. Land Use: The Project Team planned to utilize the same laydown yard with the Supply Line 43-121 South Project for all sections of the Supply Line 43-121 North Project.
9. Valves: The Project Team planned to install a new [REDACTED] MLV on the pipeline and planned for a new [REDACTED] valve on the lateral Supply Line 43-44.
10. Tie-In: The Project Team planned to tie-in directly to Supply Line 43-121 South Replacement Project in the south and existing Supply Line 43-121 at the north.

D. Scope Changes

Through engineering, design, and planning activities, SoCalGas and SDG&E determined that changes in scope were appropriate to enhance the design of the Project and address engineering factors. As a result, the preliminary cost estimate does not fully reflect the final scope. The Project Team planned to execute the entirety of Supply Line 43-121 North as a single project (Sections 1 through 4), however due to unsuitable pipe on Supply Line 43-121, the Supply Line 43-121 South Replacement Project relocated the tie-in location to tie-in to Supply Line 43-121 North Section 1 and separated Section 1 from the remaining work on Supply Line 43-121 North. This allowed the Project Team to accommodate the tie-in requirements and complete the tie-in for the Supply Line 43-121 South Replacement Project into new pipe of Supply Line 43-121 North Section 1, as shown in Figure 3.

Pipeline Safety Enhancement Plan Final Report Supply Line 43-121 North Section 1 Replacement Project

Figure 3: Supply Line 43-121 North and South Isolation Schematic

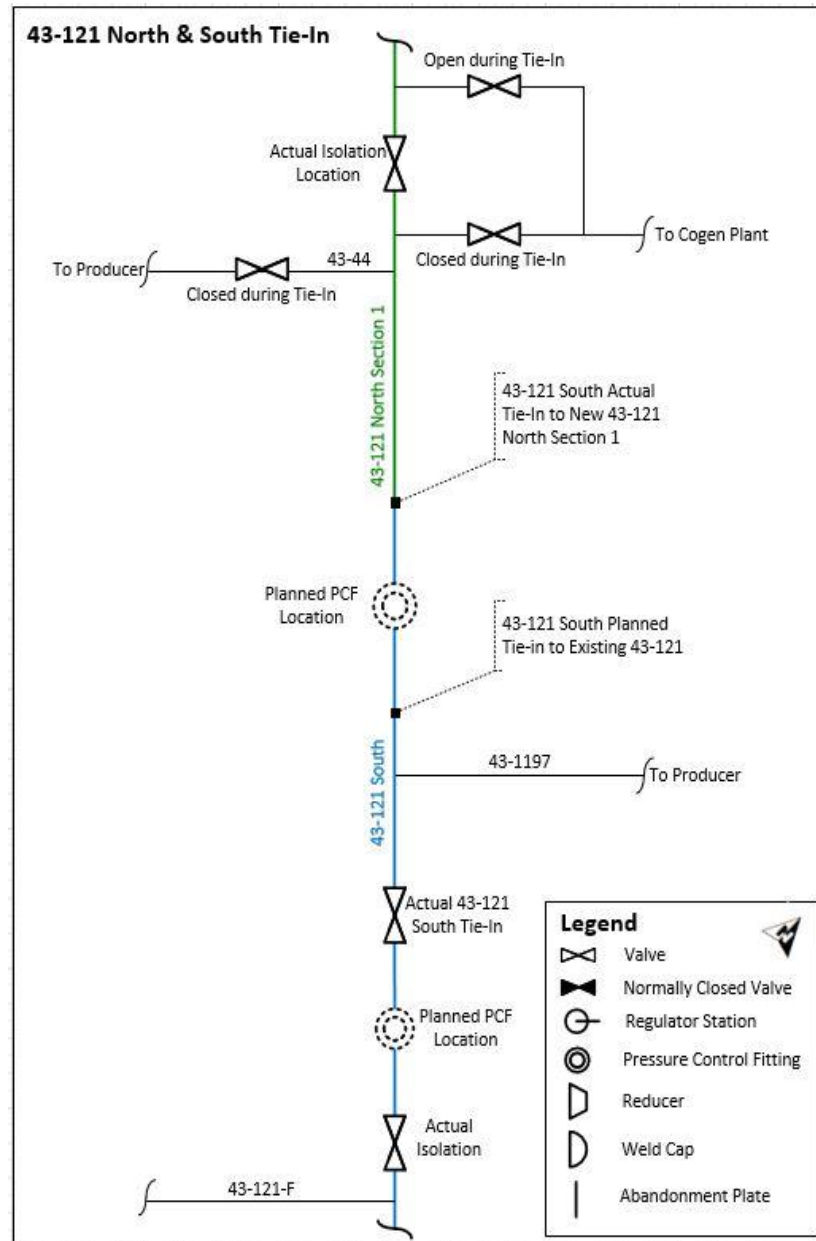

Pipeline Safety Enhancement Plan Final Report
Supply Line 43-121 North Section 1 Replacement Project

III. CONSTRUCTION

A. Construction Contractor Selection

The Project Team prepared an initial cost estimate based on the preliminary design including all Replacement Sections on Supply Line 43-121 North. Following completion of the engineering, design, and planning activities described above, SoCalGas and SDG&E entered into a competitive bidding process to select a construction contractor, that included the updated design described in the discussion of notable Scope Changes above. SoCalGas and SDG&E awarded the construction contract to the bidder that best met the selection criteria for this project.

1. SoCalGas and SDG&E's Preliminary Construction Cost Estimate (*confidential*):

SoCalGas and SDG&E's preliminary cost estimate for construction was

██████████⁷.

2. Construction Contractor's Bid (*confidential*): The Construction Contractor's Bid was

██████████⁸, which was ██████████ than SoCalGas and SDG&E's preliminary cost estimate for construction.

⁷ Estimated cost is for the original scope of Supply Line 43-121 North containing all four sections.

⁸ Construction Contractor Bid only accounts for cost of Supply Line 43-121 North Section 1.

Pipeline Safety Enhancement Plan Final Report
Supply Line 43-121 North Section 1 Replacement Project

B. Construction Schedule

Table 3: Construction Timeline

Phase 1	
Construction Start Date	08/01/2016
Construction Completion Date	11/16/2016
NOP Date	11/11/2016
Phase 2	
Construction Start Date	02/13/2017
Construction Completion Date	04/27/2017
NOP Date	03/30/2017

C. Changes During Construction

The conditions summarized below were encountered during construction. Activities to address or mitigate these conditions resulted in approximately \$1,677,000 in change orders is for the caused by an unanticipated Caltrans permit condition. The Caltrans permit was received after construction had begun for the sections permitted by other agencies. The Caltrans permit terms approved a portion of the project and required a redesign and review of a concrete cap. In order to continue construction activity, the project was broken into two phases to allow construction to proceed on the permitted portion while the Project Team redesigned and waited to receive approval from Caltrans for the final portion; however the project was demobilized before final Caltrans approval was received.

Pipeline Safety Enhancement Plan Final Report Supply Line 43-121 North Section 1 Replacement Project

1. The Project Team anticipated receipt of the Caltrans permit during construction. Caltrans approved the permit but requested additional design and review for a concrete cap over the replacement pipe due to limited depth of installation not meeting Caltrans' depth requirements. The Project Team required another phase of construction due the delay for the concrete cap design and approval. The Construction Contractor demobilized after the completion of the installation work up to the Caltrans offramp crossing. Once Caltrans approved the concrete cap design, the Project Team had already awarded the Supply Line 43-121 North Section 2, 3, and 4 construction contract and requested the awarded Construction Contractor to complete the replacement work within Caltrans ROW, construction of the concrete cap due to limited depth of cover, and final tie-in work on Supply Line 43-121 North Section 1 under a time and material basis.

Pipeline Safety Enhancement Plan Final Report Supply Line 43-121 North Section 1 Replacement Project

Figure 4: Excavation of Trench

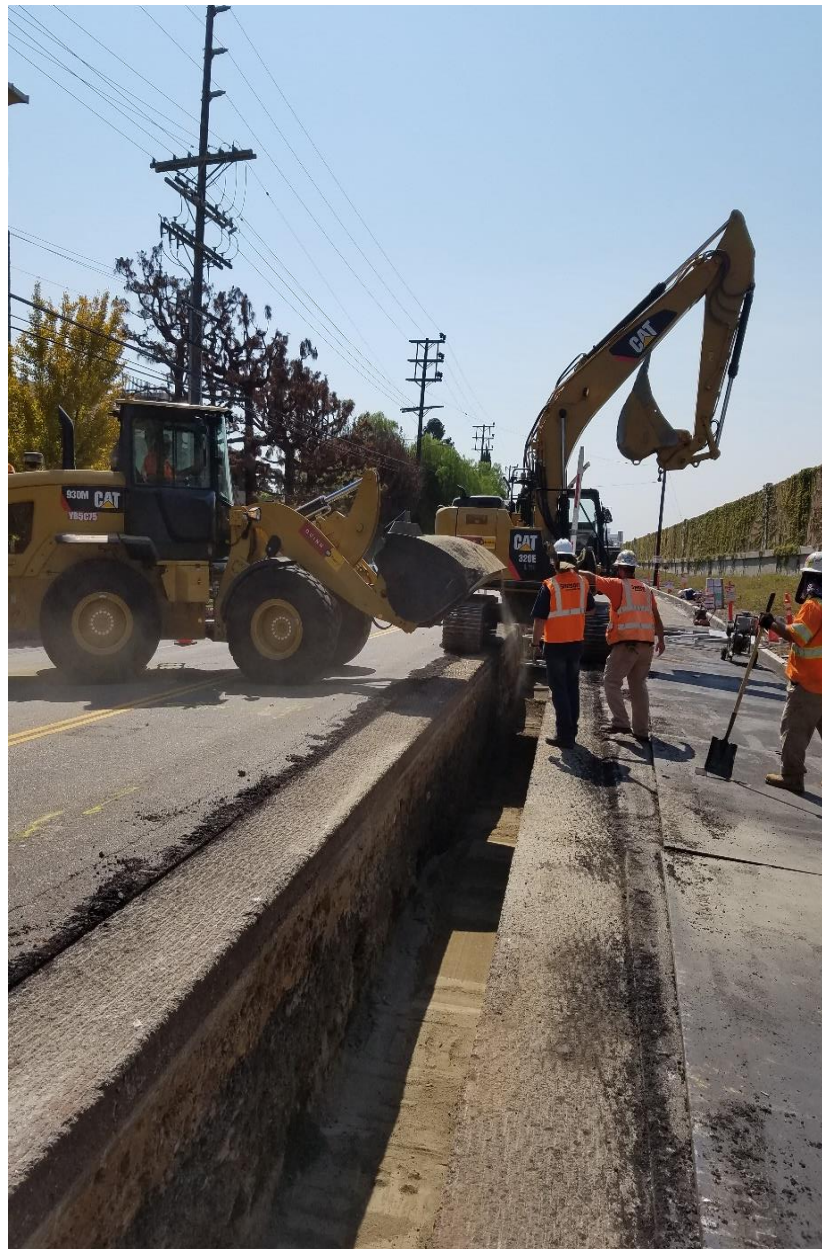

Pipeline Safety Enhancement Plan Final Report
Supply Line 43-121 North Section 1 Replacement Project

Figure 5: Installing Pipe String into Trench



Pipeline Safety Enhancement Plan Final Report
Supply Line 43-121 North Section 1 Replacement Project

Figure 6: Removal of Existing Pipeline for Section of Remove and Replace

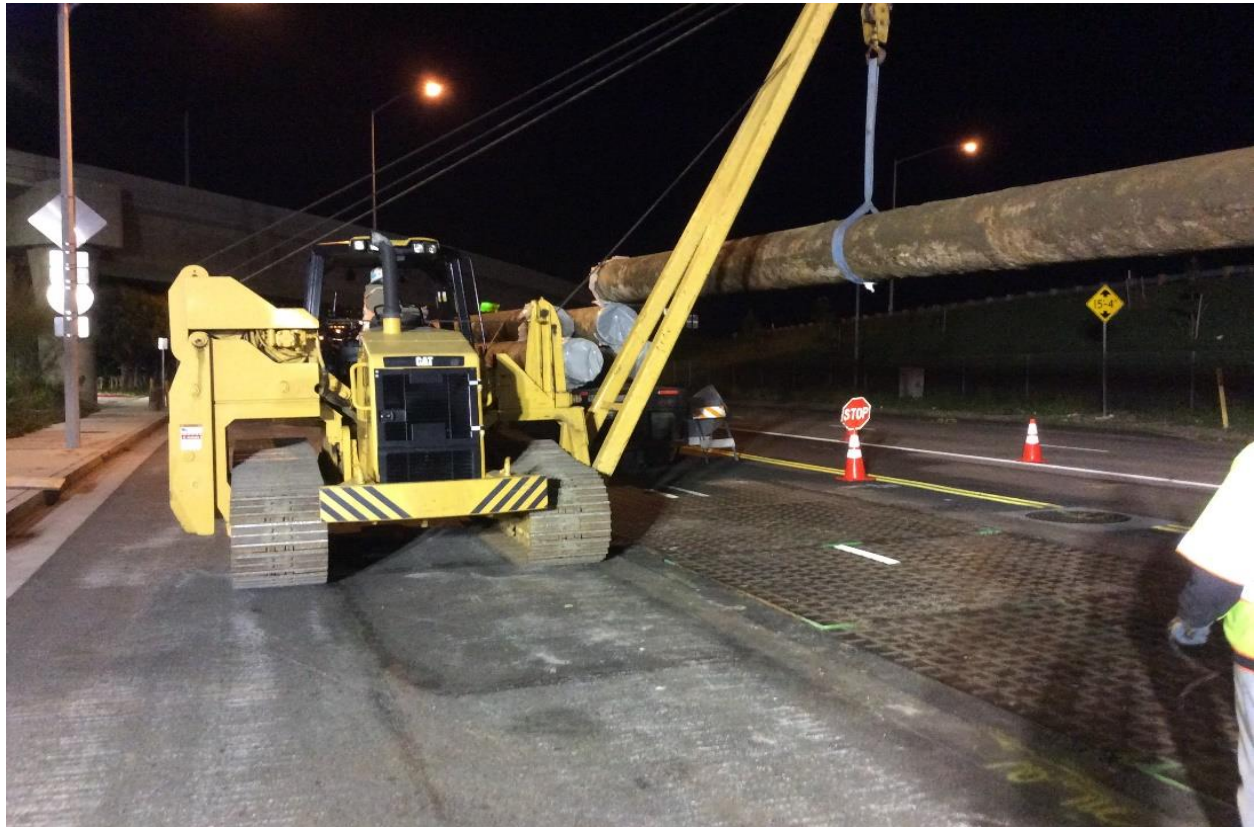

Pipeline Safety Enhancement Plan Final Report Supply Line 43-121 North Section 1 Replacement Project

Figure 7: Installed Concrete Cap Over Pipeline within Caltrans ROW

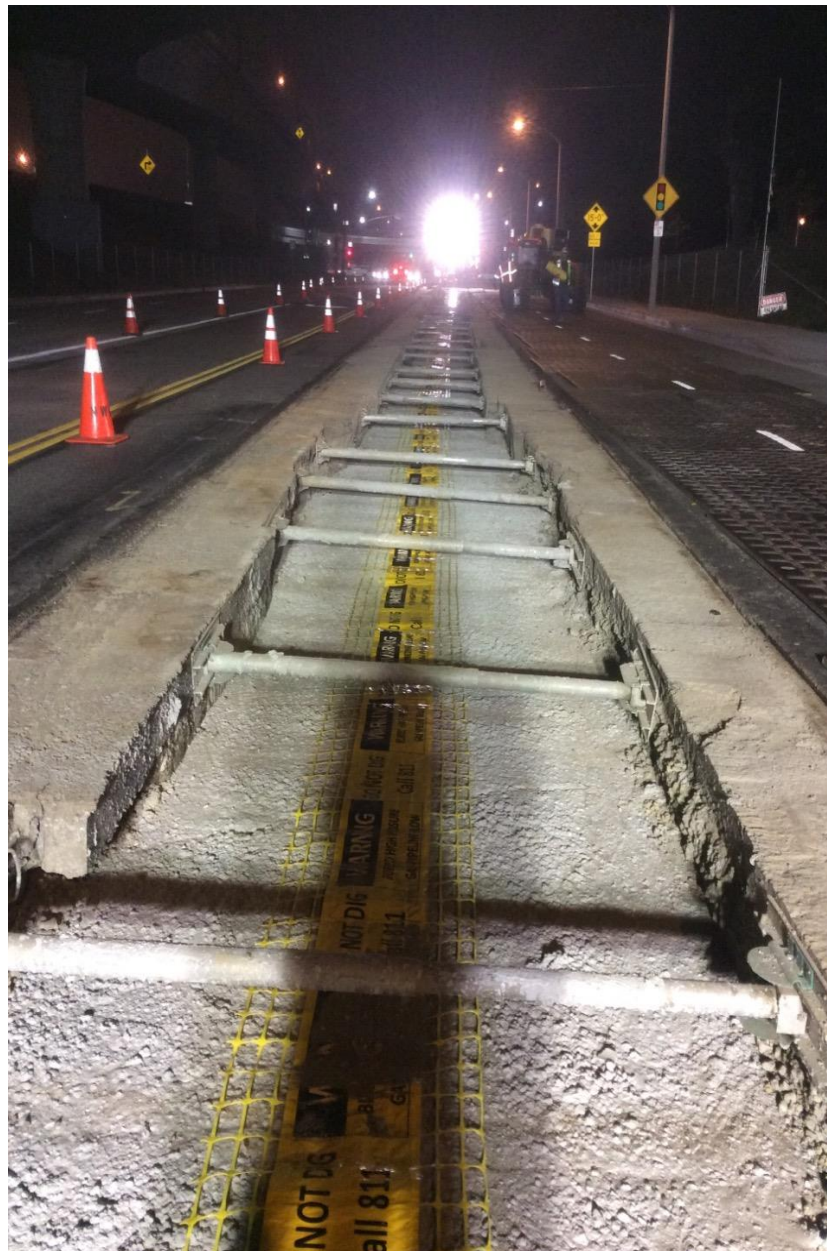

Pipeline Safety Enhancement Plan Final Report
Supply Line 43-121 North Section 1 Replacement Project

D. Commissioning and Site Restoration

Commissioning activities include restoration of the site, final inspection and placement of the pipeline back into service, transportation and disposal of hydrotested water and hazardous material, and site demobilization. Closeout activities include development of final drawings, finalization of a reconciliation package, and updates to company recordkeeping systems to reflect the completed scope of work.

Pipeline Safety Enhancement Plan Final Report
Supply Line 43-121 North Section 1 Replacement Project

IV. PROJECT COSTS

A. Cost Avoidance Actions

SoCalGas and SDG&E exercised due diligence in the planning, design, and construction activities for this project to minimize or avoid costs when prudent to do so. As discussed above, the Project Team conducted a site visit to identify and incorporate discernible site conditions into the engineering, design, and planning of the Project. Specific example of cost avoidance action taken on this project are:

1. Materials: The change in pipe diameter reduced costs for material because a standard pipe diameter was selected, along with all costs associated with handling and installing the replacement line.
2. Land Use: A month to month lease and a shared yard across multiple sections of the Supply Line 43-121 Replacement minimized the cost of long term leases.

B. Cost Estimate

Based on the preliminary design, once the project scope was confirmed for all sections of Supply Line 43-121 North and engineering, design, and planning activities were underway, SoCalGas and SDG&E prepared an estimate of the Direct Costs of the Project in the amount of \$48,651,895. This estimate was prepared in March of 2014, using the “SCG Pipeline Estimate Template Rev 2” estimating tool, the most current version of the PSEP Estimate Template at the time. The Project Team considered the conditions known at the time to prepare the preliminary Direct Cost estimate. This estimate reflects the projected Labor, Material, and Services costs anticipated to be incurred to execute the Project.

SoCalGas and SDG&E estimated Indirect Costs of the Project based on the estimated Direct Costs and other project-related variable

Pipeline Safety Enhancement Plan Final Report
Supply Line 43-121 North Section 1 Replacement Project

C. Actual Direct and Indirect Costs

Actual Direct Costs reflect the Labor, Material and Service costs incurred to execute the Project. Actual Indirect Costs reflect costs for incremental overhead loaders in accordance with Company overhead allocation policies. The total loaded cost of the Project is \$15,990,508.

Table 4: Estimated and Actual Direct Costs and Variances

Direct Costs (\$)	Estimate ⁹	Actuals ¹⁰	Delta Over/(Under)
Company Labor	832,858	350,100	(482,758)
Materials	2,198,166	514,962	(1,683,204)
Construction Contractor	29,476,194	7,832,982	(21,643,212)
Construction Management & Support	2,811,868	1,050,695	(1,761,173)
Environmental	1,348,600	236,017	(1,112,583)
Engineering & Design	1,791,947	1,514,375	(277,572)
Project Management & Services	3,528,892	533,884	(2,995,008)
ROW & Permits	1,521,300	527,245	(994,055)
GMA	5,142,070	1,602,396	(3,539,674)
Total Direct Costs	48,651,895	14,162,655	(34,489,240)

⁹ Estimated cost is for the original scope of Supply Line 43-121 North containing all four sections.

¹⁰ Actual cost only accounts for cost of Supply Line 43-121 North Section 1.

Pipeline Safety Enhancement Plan Final Report
Supply Line 43-121 North Section 1 Replacement Project

Table 5: Estimated and Actual Indirect Costs, Total Costs, and Variances

Indirect Costs/Total Costs (\$)	Estimate ¹¹	Actuals ¹²	Delta Over/(Under)
Overheads	3,885,420	1,123,790	(2,761,630)
AFUDC	7,759,032	675,355	(7,083,677)
Property Taxes	1,606,305	28,708	(1,577,597)
Total Indirect Costs	13,250,757	1,827,853	(11,422,904)
Total Direct Costs	48,651,895	14,162,655	(34,489,240)
Total Loaded Costs	61,902,652	15,990,508	(45,912,144)

D. Disallowance

There was no disallowance for Supply Line 43-121 North Section 1 Replacement Project as there were no post-1955 segments included in the Project without records that provide the minimum information to demonstrate compliance with then applicable industry standards or regulatory strength testing and recordkeeping requirements.

¹¹ Estimated cost is for the original scope of Supply Line 43-121 North containing all four sections.

¹² Actual cost only accounts for cost of Supply Line 43-121 North Section 1.

Pipeline Safety Enhancement Plan Final Report
Supply Line 43-121 North Section 1 Replacement Project

V. CONCLUSION

SoCalGas and SDG&E enhanced the safety of their integrated natural gas transmission system by prudently executing the Supply Line 43-121 North Section 1 Replacement Project. Through this Replacement Project, SoCalGas and SDG&E successfully replaced 1.009 miles of pipe and increased piggability in the City of Los Angeles. The total loaded cost of the Project is \$15,990,508.

SoCalGas and SDG&E executed this project prudently by analyzing alternative routes to verify an offset alignment prior to proceeding with the replace in place efforts and coordinating with other replacement projects to maintain system capacity and feed during shut-ins.

SoCalGas and SDG&E engaged in prudent cost avoidance efforts by negotiating change order values with the Construction Contractor reducing overall cost impact to the Project.

End of Supply Line 43-121 North Section 1 Replacement Project Final Report

Pipeline Safety Enhancement Plan Final Report
Supply Line 43-121 South Replacement Project

I. SUPPLY LINE 43-121 SOUTH REPLACEMENT PROJECT

A. Background and Summary

Supply Line 43-121 is a [REDACTED] diameter transmission pipeline that runs approximately 15 miles along several major arterial roads and parallels Interstate 405, through highly-developed and congested residential and commercial areas in the City of Los Angeles. The pipeline is primarily routed across a Class 3 location and traverses some Class 1, 2, and 4 locations. This report describes the activities associated with the Supply Line 43-121 South Replacement Project, which consists of the replacement of 1.477 miles of pipeline and the installation of two mainline valves (MLVs) and bridle assemblies. The specific attributes of this Project are detailed in Table 1 below. The total loaded cost of the Project is \$35,844,365.

Pipeline Safety Enhancement Plan Final Report
Supply Line 43-121 South Replacement Project

Table 1: General Project Information

Project Name	Supply Line 43-121 South		
Project Type	Replacement		
Length	1.477 miles		
Location	Los Angeles		
Class	Class 4		
MAOP (<i>confidential</i>)	[REDACTED]		
Pipe Vintage	1930		
Construction Start	08/25/2014		
Construction Finish	11/08/2016		
Original Pipe Diameter (<i>confidential</i>)	[REDACTED]		
New Diameter (<i>confidential</i>)	[REDACTED]		
Original SMYS ¹ (<i>confidential</i>)	[REDACTED]		
New SMYS (<i>confidential</i>)	[REDACTED]		
Project Costs (\$)	Capital	O&M	Total
Loaded Project Costs	35,844,365	-	35,844,365
Loaded Disallowed Costs	-	-	-

¹ Highest percentage of Specified Minimum Yield Strength (SMYS) of Category 4 Criteria pipe.

Pipeline Safety Enhancement Plan Final Report
Supply Line 43-121 South Replacement Project

B. Maps and Images

Figure 1: Satellite Image of Supply Line 43-121 South Replacement Project

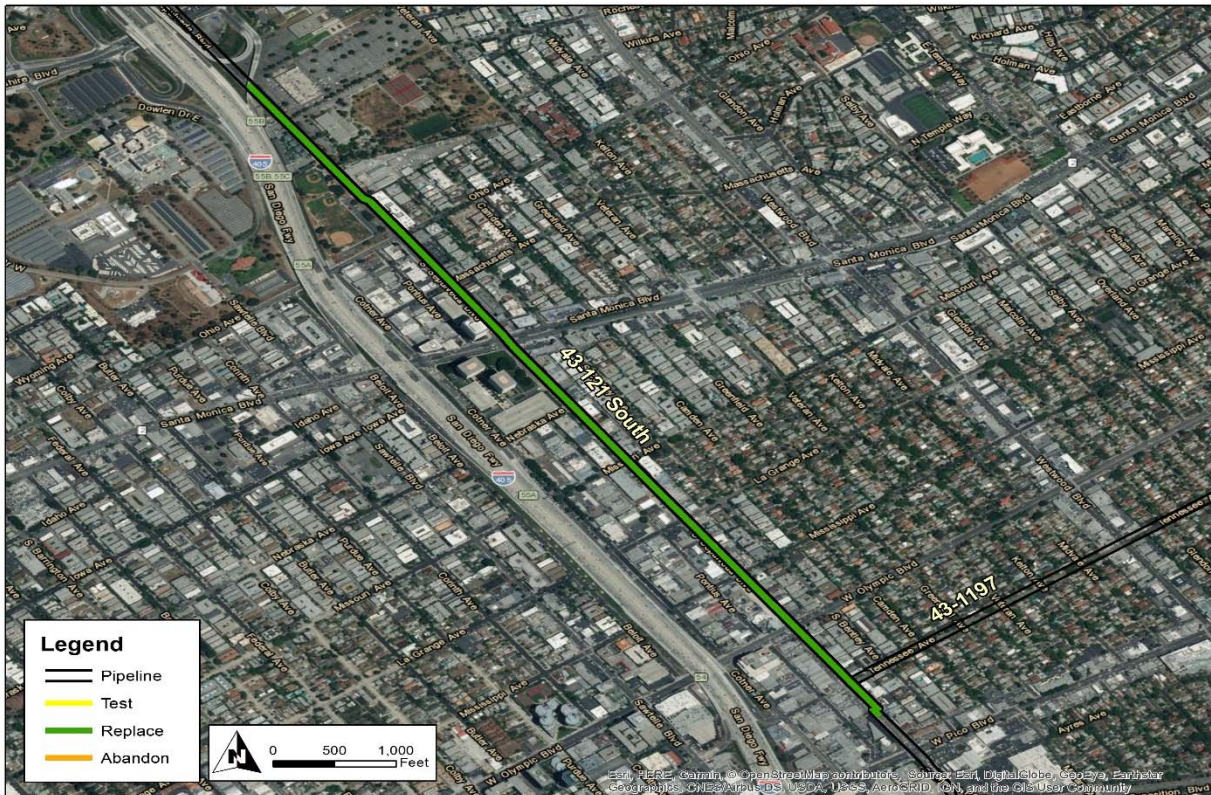

Pipeline Safety Enhancement Plan Final Report
 Supply Line 43-121 South Replacement Project

Figure 2: Overview Map of Supply Line 43-121 South Replacement Project

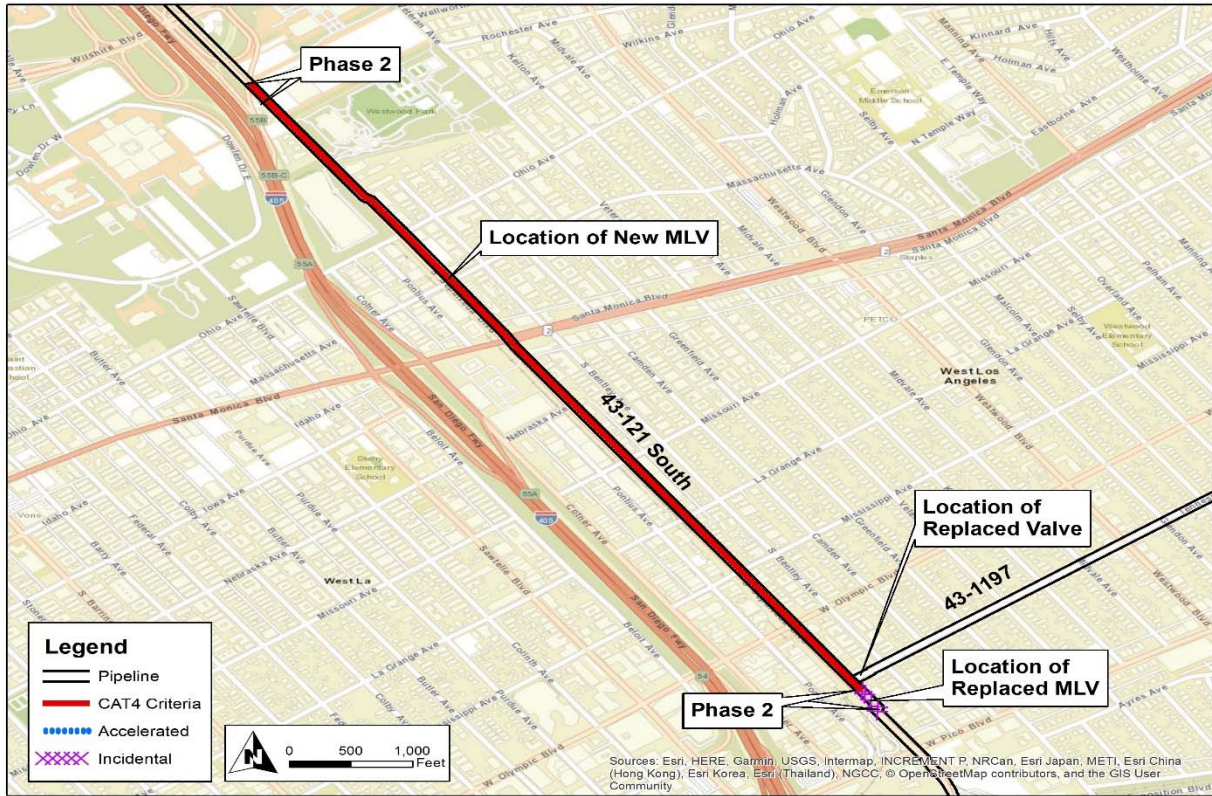

Pipeline Safety Enhancement Plan Final Report
Supply Line 43-121 South Replacement Project

II. ENGINEERING, DESIGN, AND PLANNING

A. Project Scope

Table 2: Mileage Information

	Criteria	Accelerated	Incidental	New	Total ²
Final Mileage	1.358 mi.	0 mi.	0.039 mi.	0.080 mi.	1.477 mi.
	7,171 ft.	0 ft.	203 ft.	425 ft.	7,799 ft.

SoCalGas and SDG&E presented a conceptual project scope in workpapers supporting the 2011 PSEP filing³. Prior to initiating execution of the Project in 2014, SoCalGas and SDG&E reviewed existing pipeline records to validate the scope of the Project. During the Engineering, Design, and Planning phase, SoCalGas and SDG&E further refined the scope. The progression of project scope is summarized as follows:

1. 2011 PSEP Filing: SoCalGas and SDG&E identified Supply Line 43-121 as a Phase 1A Replacement Project comprised of 2.766 miles of Category 4 Criteria pipe and 1.645 miles of Accelerated pipe.
2. Scope Validation:
 - a. Through scope validation activities, after the 2011 filing and before initiating execution of the Project, SoCalGas and SDG&E increased the scope of the Project by 0.524 miles of Category 4 Criteria pipe and removed Accelerated mileage from the project scope. The net effect was a reduction of the total Project mileage to 3.72 miles.

² Values may not add to total due to rounding.

³ See Amended PSEP of SoCalGas and SDG&E, submitted December 2, 2011, in R.11-02-019 and subsequently transferred to A.11-11-002.

Pipeline Safety Enhancement Plan Final Report
Supply Line 43-121 South Replacement Project

- b. After additional review, the Project Team determined that the remaining Accelerated mileage was either Category 4 Criteria or removed from scope. Total Category 4 Criteria mileage for the Project increased to 3.310 miles.
3. Engineering, Design, and Constructability:
- a. To mitigate customer impacts, the Project Team decided to sectionalize the Project into two separate replacement projects: Supply Line 43-121 North Replacement Project⁴ and Supply Line 43-121 South Replacement Project.
 - b. The Project Team determined that the scope of Supply Line 43-121 South Replacement Project consisted of 1.376 miles of Category 4 Criteria pipe. Due to permitting conflicts within Caltrans right-of-way (ROW), the Project Team deferred 0.018 miles of Category 4 Criteria pipe to the Supply Line 43-121 North Section 1 Replacement Project, reducing the scope of the Supply Line 43-121 South Replacement Project.
 - c. The Project Team included 0.08 miles of new pipe to navigate conflicting utilities and for tie-ins to existing lateral connections.
 - d. The Project Team included Incidental mileage to extend the tie-in location to an unobstructed location and to replace the bridle connection with a piggable MLV.

⁴ Supply Line 43-121 North Section 2, 3, 4 Replacement Project will be included for reasonableness review in a future filing.

Pipeline Safety Enhancement Plan Final Report
Supply Line 43-121 South Replacement Project

4. Final Project Scope: The final project scope consists of a 1.477-mile Replacement. This is 424 feet longer than the original length due to pipeline offset and routing around utilities extending the tie-in location during construction, and the installation of two MLVs and bridle assemblies.

B. Decision Tree Analysis

SoCalGas and SDG&E performed a PSEP Decision Tree analysis of Supply Line 43-121 South and confirmed the project design should commence as a Replacement Project.

Pipeline segments installed prior to 1946 that are not capable of being assessed using in-line inspection technology are identified for replacement under the approved PSEP Decision Tree. As explained in the testimony supporting the approved PSEP, as part of the work previously completed during implementation of federal gas transmission pipeline integrity management regulations (49 CFR 192, Subpart O), SoCalGas and SDG&E previously identified, retrofitted and in-line inspected pre-1946 transmission pipelines that were constructed using acceptable welding techniques and are operationally suited to in-line inspection. The remaining pre-1946 segments in the SoCalGas/SDG&E system are not suited for in-line inspection, likely have non-state-of-the-art welds, and would require significant investment for retrofitting to accommodate in-line inspection tools. Accordingly, consistent with the Commission's directive in D.11-06-017 to "address retrofitting pipeline to allow for inline inspection tools," the requirement in California Public Utilities Code section 958 that upon completion of the PSEP, where warranted, pipelines are to be capable of accommodating in-line inspection devices, and the overarching objectives of PSEP to enhance the safety of the pipeline system in a proactive, cost effective manner, the approved PSEP Decision Tree identifies pre-1946 non-piggable pipeline segments for abandonment and/or replacement.

Pipeline Safety Enhancement Plan Final Report
Supply Line 43-121 South Replacement Project

Through this Decision Tree analysis, SoCalGas and SDG&E identified replacement as the more prudent option. Key considerations that support SoCalGas and SDG&E's determination to replace this segment include:

1. Shut-In Analysis: The Project Team completed a Request for Engineering Review (RER) analysis and concluded that customers could not be shut-in for the duration of a hydrotest. Major customers on this line include a cogeneration plant that feeds a major university and a hospital, along with Producers.
2. Community Impacts: Significant traffic impacts and occasional noise.
3. Permit Conditions: Multiple issues relating to traffic control, work times, moratoriums, and coordinating between multiple permitting agencies.
4. Piggability: Non-piggable.
5. Pipe Vintage: 1930.
6. Existing Pipe Attributes: Varying pipe diameters.
7. Longseam Type: Unknown.
8. Longseam Repair History: No identified issues.
9. Condition of Coating: Deteriorating.
10. History of Leaks: No identified issues.

C. Engineering, Design, and Planning Factors

SoCalGas and SDG&E reviewed pipeline drawings and other information, contacted internal planning groups, communicated with external stakeholders, conducted survey activities, including reviewing public records and ground penetrating radar of the area to confirm the presence of underground utilities and substructures, and completed a pre-

Pipeline Safety Enhancement Plan Final Report
Supply Line 43-121 South Replacement Project

design site walk. Key factors that influenced the engineering and design of the Project are as follows:

1. Shut-In Analysis: As discussed above, the Project Team completed an RER analysis that concluded SoCalGas and SDG&E could not shut-in the line and needed to maintain service to customers through alternative means.
2. Customer Impacts:
 - a. The Project Team determined that a shut-in of the cogeneration plant should be avoided since it serves a hospital and a university.
 - b. The Project Team also determined that a shut-in would require coordination with the Producers on this line. When a Producer is shut-in, an alternative means of capturing or transporting the produced natural gas is desired unless the processing facility can simultaneously shutdown operations. A large Producer's shut in schedule could not accommodate SoCalGas and SDG&E's shut-in schedule; therefore, the Project Team designed an offset replacement with stopples to avoid isolation of the large Producer and customers.
3. Diameter Changes: Although this pipeline was comprised of varying diameters, the predominant existing pipeline diameter was [REDACTED]. SoCalGas and SDG&E analyzed typical load demands and future capacity planning for a replacement diameter of [REDACTED] and determined that to be sufficient. In addition, by standardizing the pipeline it would be made piggable.
4. Schedule Coordination: The Project Team coordinated with other PSEP projects to fully maintain feed and pressure to this portion of the integrated natural gas transmission system.

Pipeline Safety Enhancement Plan Final Report
Supply Line 43-121 South Replacement Project

- a. The Project Team scheduled the construction of Supply Line 43-121 South Replacement Project and Supply Line 43-121 North Replacement Project to be sequential to maintain feed from the north and the south respectively during both construction projects.
 - b. The Project Team coordinated with the tie-in work on the Supply Line 37-07 Replacement Project, which had to be completed and in operation before Supply Line 43-121 could be shut-in. The upsizing of Supply Line 37-07 allowed for increased capacity to the system to meet the demand of isolating Supply Line 43-121.
5. Valves: The Project Team planned for an MLV with bridle at the connection to Supply Line 43-121-F (at the south tie-in).
6. Permit Conditions: The Project Team identified significant permitting challenges due to the heavily-trafficked and congested area along Sepulveda Boulevard including encroachment and traffic control permits from the City of Los Angeles, County of Los Angeles, and Caltrans and a noise variance permit from the Los Angeles Police Department.

D. Scope Changes

Through engineering, design, and planning activities, SoCalGas and SDG&E determined that changes in scope were appropriate to enhance the design of the Project and address engineering factors. As a result, the preliminary cost estimate does not fully reflect the final scope. Summarized below are notable changes in scope made after the preliminary cost estimate was developed and approved.

1. Construction Schedule: To complete the project as soon as practicable and ahead of the Holiday Moratorium, the Project Team mobilized construction for the straight

Pipeline Safety Enhancement Plan Final Report
Supply Line 43-121 South Replacement Project

sections of pipe that were already designed while continuing the engineering, design, and permitting of the tie-ins and major crossings. The Project Team planned to complete the engineering, design and permitting prior to completing construction of the straight sections of pipe.

2. Known Substructures: Based on information gathered from utility research, the Project Team had adjusted the alignment to avoid substructures. The Project Team planned to complete potholing ahead of construction to complete Engineering and Design of the remaining scope of the project.
 - a. Potholing relies heavily on the information received from historical records of utility owners to initiate points of inspection. Potholing only provides information regarding the exposed point and does not capture any additional information beyond or beneath the exposed section and is primarily used to validate the results of received records.
 - b. Due to the considerable number of existing substructures along Sepulveda Boulevard found through potholing and construction, the Project Team also conducted assessments using Ground Penetrating Radar (GPR) to verify the presence of utilities between potholed locations. This provided additional information to validate known alignments where a utility was not exposed during potholing or capture possible unknown substructures that were not captured in utility research. GPR is limited to identifying utilities that are unobstructed and does not reveal any information about conditions beneath an identified utility or obstruction.
 - c. Sepulveda Boulevard is a highly-congested utility corridor. During recent widening projects of the Interstate 405 freeway, utility agencies utilized Sepulveda Boulevard for many of the needed replacements and relocations in

Pipeline Safety Enhancement Plan Final Report
Supply Line 43-121 South Replacement Project

this area. Records from recent work were not always readily available due to in progress record keeping at the time of the requests.

3. Permit Conditions: The Project Team encountered delays obtaining the Caltrans encroachment permit for the tie-in work on the north end of the Project underneath the on and off ramps to the Interstate 405 freeway. As a result, the Project Team could not complete the permitting ahead of the completion of construction as originally planned. This resulted in the Project Team splitting construction into two phases with separate mobilizations, Phase 1 for pipe lay activities that had already been initiated, and Phase 2 for pipe lay activities requiring an encroachment permit in Caltrans ROW for traffic control plans, hydrotesting, and tie-ins.
4. Pipe Condition: At the onset of Phase 2 construction, the Project Team identified the condition of the 1930 pipe at the planned tie-in point and stopple isolations as non-suitable. The Project Team selected a new isolation point to extend beyond the 1930-vintage pipe. By extending the isolation location, the Project Team then removed the stopple isolations from the design and used the existing valve locations for isolation upstream and downstream of the tie-in locations.
 - a. The new isolation locations affected additional customers and required coordination with a remaining Producer to schedule the shut-in. As a result, the Project Team required compressed natural gas (CNG) for only one customer and served the cogeneration plant through a bridle at the isolation location.
5. Schedule Coordination: The new isolation locations encompassed the extents of the Supply Line 43-121 North Section 1 Replacement Project⁵ originally scheduled to start after the Supply Line 43-121 South Project and would resume construction from

⁵ The Supply Line 43-121 North Section 1 Replacement Project is included for review in this Application. Details can be found in these workpapers.

Pipeline Safety Enhancement Plan Final Report
Supply Line 43-121 South Replacement Project

the north tie-in. Due to delays during construction of the Supply Line 43-121 South Replacement Project, the construction schedules overlapped. The Project Team utilized the extended shut-in location for a single isolation of this section of the pipeline for both replacement projects and proceeded with construction of Supply Line 43-121 North Section 1 during construction of Phase 2. This also resolved the tie-in constraints as the North Section 1 Project would tie into suitable pipe, see Figure 4.

6. Land Acquisition: Three properties were acquired for this project near the project location to utilize as a laydown yard and work areas to perform construction activities, store equipment and materials and station mobile office trailers. These properties were maintained for the duration between construction of Phase 1 and Phase 2, as well as the overall extended duration for construction than what had been assumed in the original preliminary cost estimate.
7. Lateral Connections:
 - a. The Project Team learned through communications with the Operating District of the District's plan to install a new regulator station that would be supplied from Supply Line 43-121 through a new lateral Supply Line 43-121-O and revised the project design to accommodate the planned system change with a new MLV and bridles.
 - b. The Project Team added an [REDACTED] tap valve at the connection to Supply Line 43-1197.

Pipeline Safety Enhancement Plan Final Report
Supply Line 43-121 South Replacement Project

Figure 3: Overall Map of Supply Line 43-121 North Section 1 and 43-121 South Replacement Projects

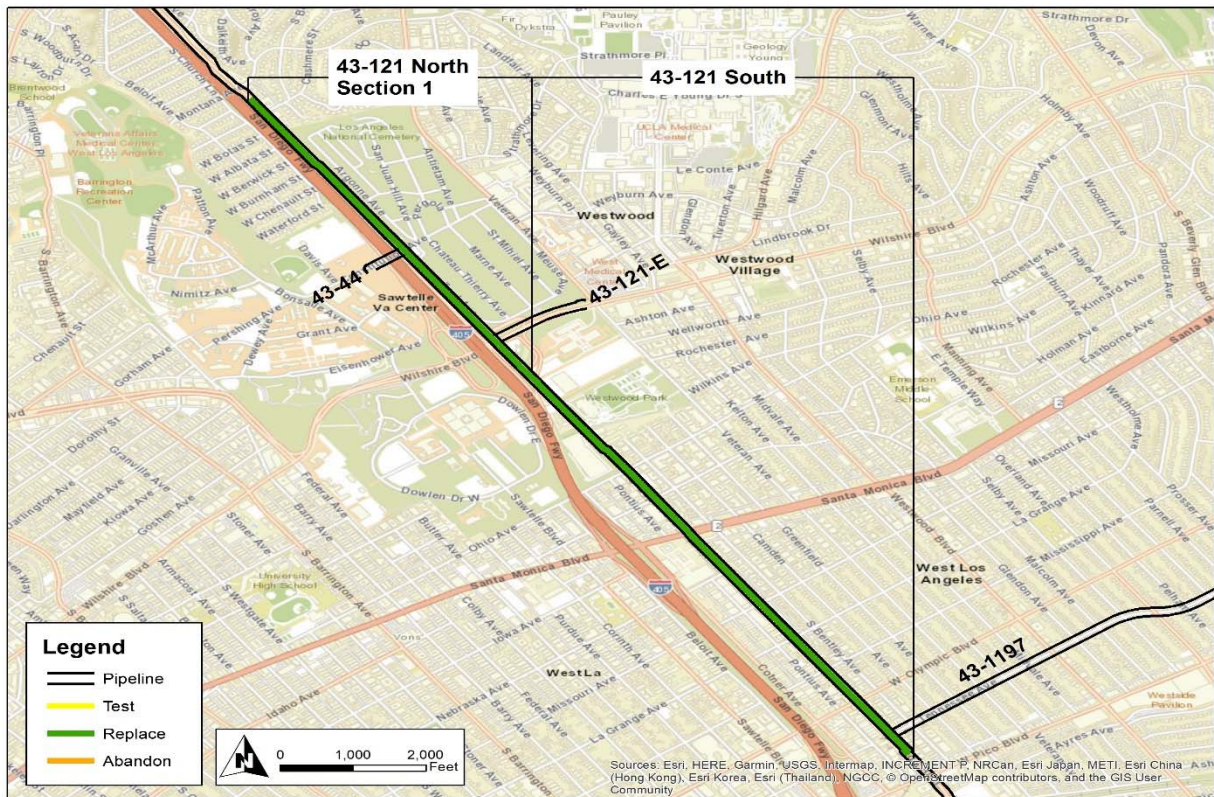

Pipeline Safety Enhancement Plan Final Report Supply Line 43-121 South Replacement Project

Figure 4: Supply Line 43-121 North and South Isolation Schematic

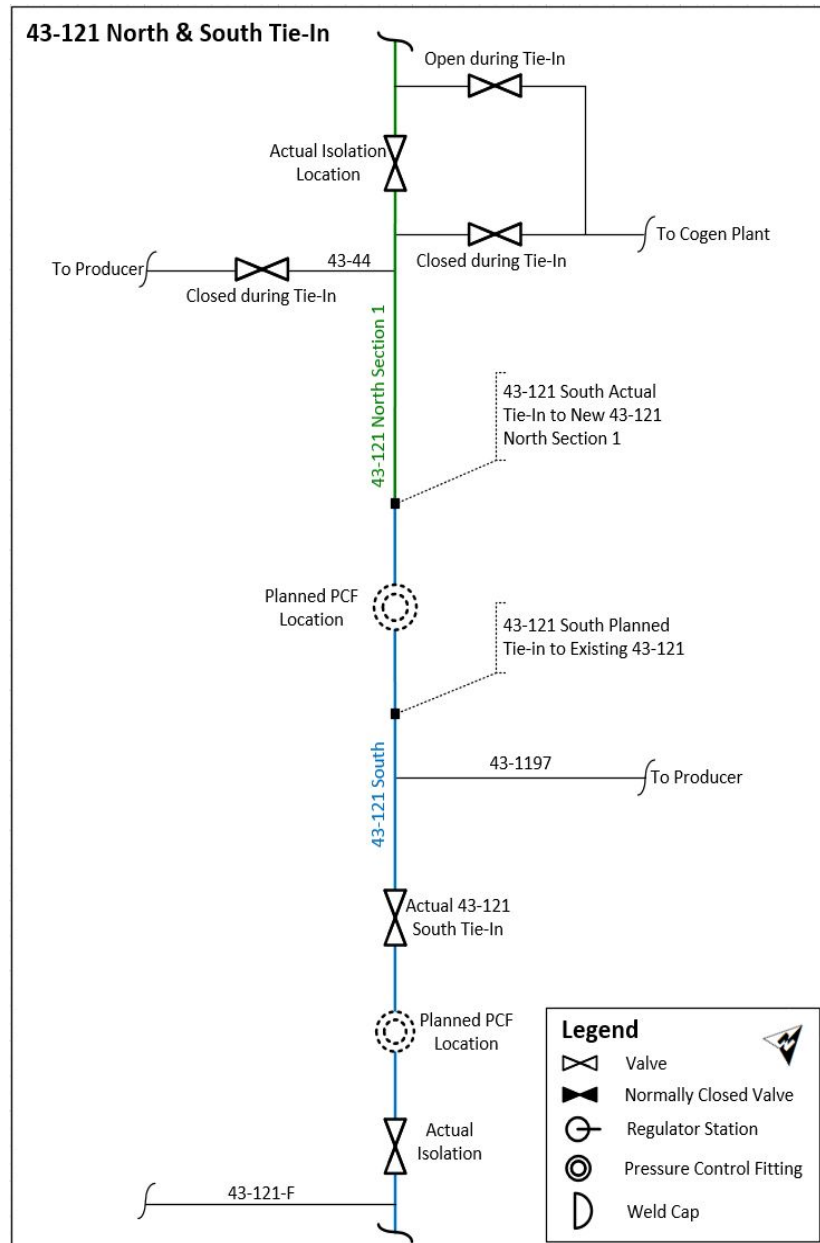

Pipeline Safety Enhancement Plan Final Report
Supply Line 43-121 South Replacement Project

III. CONSTRUCTION

A. Construction Contractor Selection

The Project Team prepared an initial cost estimate based on the preliminary design. During completion of the engineering, design, and planning activities described above, the Project Team directed the Performance Partner to prepare cost estimates for the pipe lay, Phase 1, based on a more detailed engineering design package. SoCalGas and SDG&E awarded the construction contract to the Performance Partner for Phase 1.

Permitting delays were encountered during Engineering, Design and Planning, which led SoCalGas and SDG&E to plan for a second phase of construction to complete pipe lay activities that required an encroachment permit into Caltrans ROW for traffic control plans, hydrotesting, and tie-in activities. SoCalGas and SDG&E bid out the Phase 2 work and awarded it to a different contractor.

1. SoCalGas and SDG&E's Preliminary Construction Cost Estimate (*confidential*):
SoCalGas and SDG&E's preliminary cost estimate for construction was [REDACTED].
2. Construction Contractor's Target Price Estimate for Phase 1 & 2 (*confidential*): The Construction Contractor's cost estimate for Phase 1 was [REDACTED] and for Phase 2 was [REDACTED] for a total of [REDACTED], that was [REDACTED] than SoCalGas and SDG&E's preliminary cost estimate for construction.

Pipeline Safety Enhancement Plan Final Report
Supply Line 43-121 South Replacement Project

B. Construction Schedule

Table 3: Construction Timeline

Phase 1	
Construction Start Date	08/25/2014
Construction Completion Date	05/08/2015
NOP Date	10/11/2016
Phase 2	
Construction Start Date	06/16/2016
Construction Completion Date	11/08/2016
NOP Date	10/11/2016

C. Changes During Construction

Phase 1

The conditions summarized below were encountered during construction of Phase 1. Activities to address or mitigate these unanticipated conditions resulted in approximately \$4,600,000 in change orders.

Constructability Issues: As discussed above, Sepulveda Boulevard is a highly congested utility corridor with many recently installed utilities. Figure 5 illustrates the underground congestion of utilities along Sepulveda Boulevard that inevitably led to significant construction challenges on this project. This example of a typical cross section showing underground utilities was developed for Caltrans as part of the Interstate 405 Sepulveda Pass Widening Project. Finding a suitable slot for a new pipeline with the required cover and clearances from other substructures was challenging.

During construction, the Construction Contractor exposed many petroleum, telecommunication, water, and sewer lines. It is common for substructures to not be identified in records in old streets. Due to the condition of exposed utilities and

Pipeline Safety Enhancement Plan Final Report
Supply Line 43-121 South Replacement Project

proximity of the planned installation, the Construction Contractor required additional efforts to support the exposed utilities or provide additional shoring to allow for sufficient excavation of the trench along the length of the replacement alignment.

The original engineering and design planned for bored crossings of Olympic Boulevard and Santa Monica Boulevard. Since the existing substructures were directly in conflict with the proposed bore pits, the Project Team was required to revise the design. The Project Team potholed both crossings to find a suitable path for open trench installation.

Discovery of unknown utilities along numerous locations along the alignment required a redesign of the proposed replacement to route under the substructures in various places. This extended the length of the replacement line.

Pipeline Safety Enhancement Plan Final Report
 Supply Line 43-121 South Replacement Project

Figure 5: Cross Section of Typical Substructures Beneath Sepulveda Boulevard

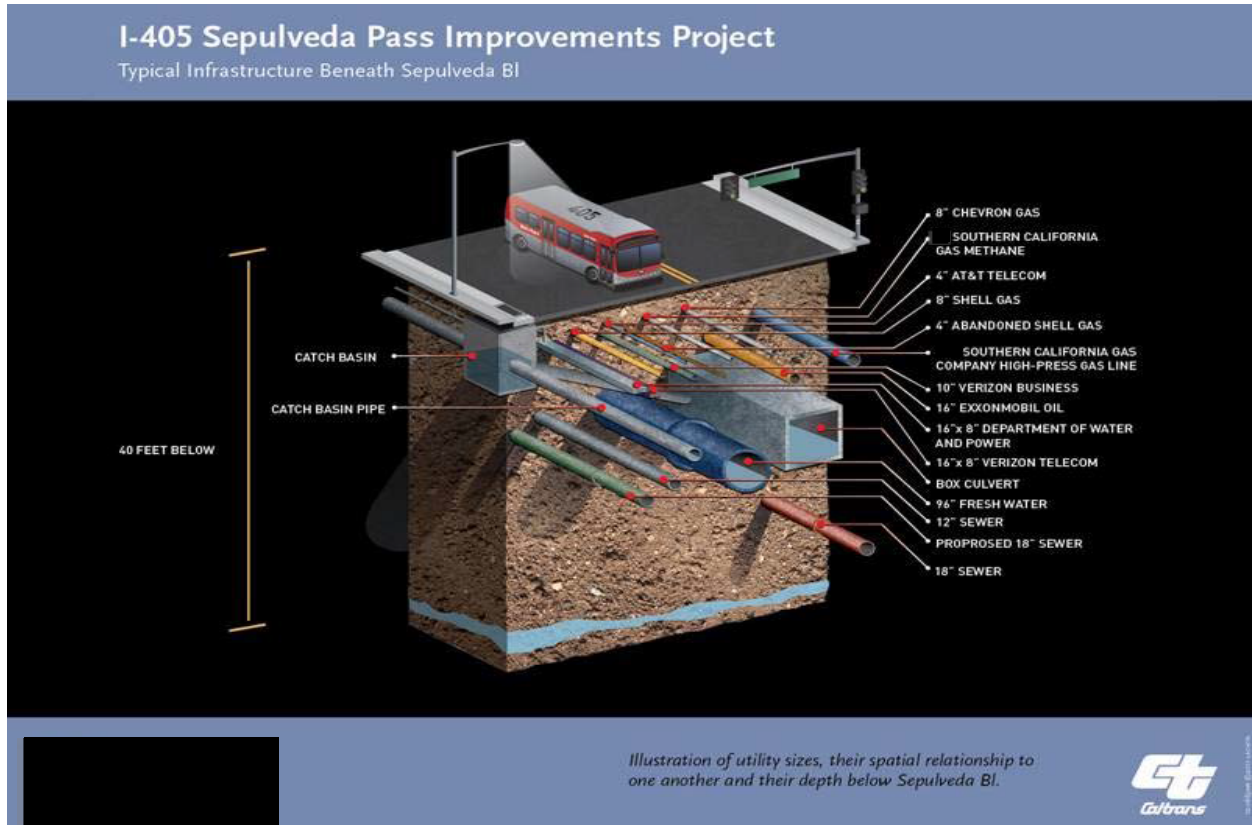

Pipeline Safety Enhancement Plan Final Report
Supply Line 43-121 South Replacement Project

2. Permit Conditions:

The construction permit initially included work hours for day and night shifts. Shortly after the start of construction, the City Inspector shortened the work hours by removing the day shift from construction to address traffic concerns. This resulted in a significant extension to the construction schedule by cutting the work hours in half. The city also requested that the Construction Contractor remove all heavy equipment daily from the ROW along Sepulveda Boulevard. This further shortened the amount of productive time each day, since the first and last portion of each shift was required to be spent moving equipment from the offsite yard to the work site in the street.

The Project Team mobilized construction with the expectation of receiving the required construction permit from the City and County of Los Angeles soon after. The Project Team did not receive the permit as expected. The Construction Contractor completed limited work within the laydown yard preparing pipe and materials between mobilization and receiving the permits.

Due to changes in the work hours, the schedule extended into a construction moratorium imposed by the City of Los Angeles. The original construction schedule indicated that construction of Phase 1 would be completed prior to the moratorium in November and Phase 2 would be ready for crews to return to complete in January of 2015. By the time of the holiday moratorium in November, however, installation of the Phase 1 pipe was not complete, and the Project Team demobilized. After the moratorium, the Construction Contractor remobilized to complete the pipe lay for phase 1 in January of 2015.

3. Materials: The Construction Contractor performed field repairs to coating.

Pipeline Safety Enhancement Plan Final Report
Supply Line 43-121 South Replacement Project

4. Schedule Delay: Unplanned delays extended the Project by approximately five months. Additional field support costs were incurred to support the completion of this project.

Phase 2

The conditions summarized below were encountered during construction of Phase 2. Activities to address or mitigate these unanticipated conditions resulted in approximately \$1,200,000 in change orders.

Soil Contamination: The Construction Contractor encountered harder than anticipated slurry backfill within the proposed pipe alignment. The Construction Contractor brought in additional equipment to excavate through the slurry and utilized the equipment in several areas.

Gas Handling: As mentioned above, the Project Team redesigned the isolation locations at the onset of construction, which necessitated gas handling changes.

The Construction Contractor assisted with the additional isolations required to address the extended isolation extents.

At the time of construction, the Project Team decided to abandon rather than isolate an existing [REDACTED] lateral. Additional effort from the Construction Contractor was required to locate and properly abandon the section of the line.

Due to the complexity of the gas handling plan, SoCalGas and SDG&E spent additional time evaluating each site prior to isolation to reduce safety risks.

The Project Team planned all lateral tie-in activities for a single 24 hour period. The actual lateral tie-ins were spread over a three-day period, due to system and resource restrictions.

Pipeline Safety Enhancement Plan Final Report
Supply Line 43-121 South Replacement Project

Substructures: As discussed above, Sepulveda Boulevard is a highly congested corridor with many installed utilities. During construction, the Construction Contractor exposed many petroleum, telecommunication, water, and sewer lines that utility outreach and subsequent potholing did not identify due to unreceived records or location adjacent to known utilities. Due to the condition of exposed utilities and proximity of the planned installation, the Construction Contractor required additional efforts to support the exposed utilities or provide additional shoring to allow for sufficient excavation of the trench along the length of the replacement alignment.

An adjacent petroleum line was determined to be too close to the new Supply Line 43-121, thus the Project Team installed steel plates as a barrier.

The Construction Contractor modified the alignment of the new pipe two feet deeper, to avoid a sewer utility in conflict with the planned installation of a valve.

During construction, a portion of an existing vault was determined to be in conflict with the location of the new proposed pipe installation. The Construction Contractor proceeded by partially removing the vault to accommodate the new pipe installation.

Pipeline Safety Enhancement Plan Final Report
Supply Line 43-121 South Replacement Project

Figure 6: Utility Congestion Within Trench at South Tie-In Location

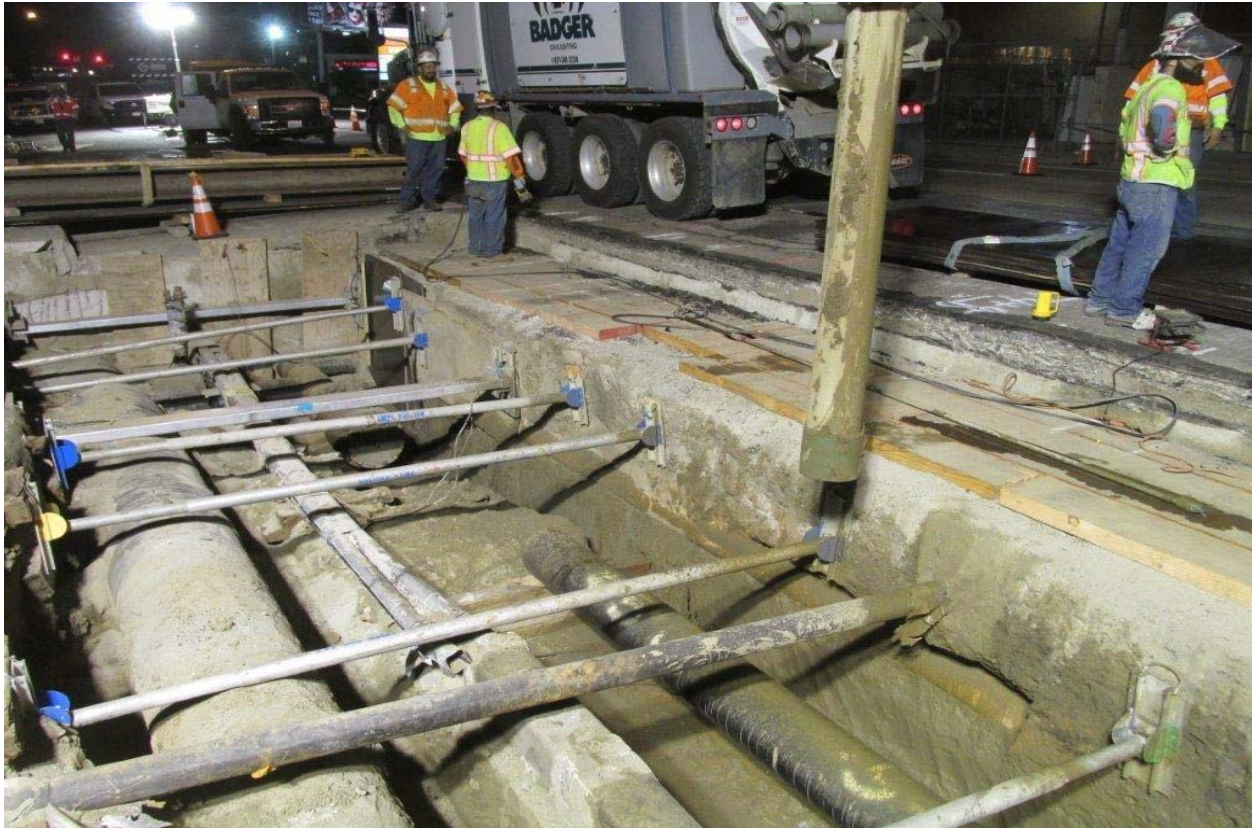

Pipeline Safety Enhancement Plan Final Report
Supply Line 43-121 South Replacement Project

Figure 7: Preparing Pipe String for Installation in Trench



Pipeline Safety Enhancement Plan Final Report
Supply Line 43-121 South Replacement Project

Figure 8: Laying Pipe String in Trench



Pipeline Safety Enhancement Plan Final Report
Supply Line 43-121 South Replacement Project

D. Commissioning and Site Restoration

Commissioning activities include restoration of the site, final inspection and placement of the pipeline back into service, transportation and disposal of hydrotested water and hazardous material, and site demobilization.

Closeout activities include development of final as-built drawings, finalization of a reconciliation package, and updates to company recordkeeping systems to reflect the completed scope of work.

Pipeline Safety Enhancement Plan Final Report
Supply Line 43-121 South Replacement Project

IV. PROJECT COSTS

A. Cost Avoidance Actions

SoCalGas and SDG&E exercised due diligence in the planning, design, and construction activities for this project to minimize or avoid costs when prudent to do so. As discussed above, the Project Team conducted a site visit to identify and incorporate discernible site conditions into the engineering, design, and planning of the Project. Specific examples of cost avoidance actions taken on this project are:

1. Engineering and Design: In lieu of using stopple fittings, the Project used existing valves as isolation points, reducing material and installation costs. The change in pipe diameter reduced costs for material because a standard pipe diameter was selected, along with costs associated with handling and installing the replacement line.
2. Land Use: A month-to-month lease and a shared yard across multiple sections of the Supply Line 43-121 Replacement Project minimized the cost of long-term leases.

B. Cost Estimate

Based on the preliminary design, once the project scope was confirmed and engineering, design, and planning activities were underway, SoCalGas and SDG&E prepared an estimate of the Direct Costs of the Project in the amount of \$16,537,140. This estimate was prepared in July of 2014, using the “SCG Pipeline Estimate Template Rev 0” estimating tool, the most current version of the PSEP Estimate Template at the time. The Project Team considered the conditions known at the time to prepare the preliminary Direct Cost estimate. This estimate reflects the projected Labor, Material and Services costs anticipated to be incurred to execute the Project.

Pipeline Safety Enhancement Plan Final Report
Supply Line 43-121 South Replacement Project

SoCalGas and SDG&E estimated Indirect Costs of the Project based on the estimated Direct Costs and other project related variables.

C. Actual Direct and Indirect Costs

Actual Direct Costs reflect the Labor, Material and Service costs incurred to execute the Project. Actual Indirect Costs reflect costs for incremental overhead loaders in accordance with Company overhead allocation policies. The total loaded cost of the Project is \$35,844,365.

Table 4: Estimated and Actual Direct Costs and Variances

Direct Costs (\$)	Estimate	Actuals	Delta Over/ (Under)
Company Labor	460,566	383,419	(77,147)
Materials	1,783,152	1,042,279	(740,873)
Construction Contractor	7,737,279	14,760,151	7,022,872
Construction Management & Support	1,238,050	3,176,180	1,938,130
Environmental	328,440	260,447	(67,993)
Engineering & Design	1,140,340	3,222,295	2,081,955
Project Management & Services	1,137,352	2,203,189	1,065,837
ROW & Permits	963,050	1,732,821	769,771
GMA	1,748,911	3,478,047	1,729,136
Total Direct Costs	16,537,140	30,258,828	13,721,688

Pipeline Safety Enhancement Plan Final Report
Supply Line 43-121 South Replacement Project

Table 5: Estimated and Actual Indirect Costs, Total Costs, and Variances

Indirect Costs/Total Costs (\$)	Estimate	Actuals	Delta Over/(Under)
Overheads	2,280,629	2,232,073	(48,556)
AFUDC	1,922,234	2,973,822	1,051,588
Property Taxes	383,011	379,642	(3,369)
Total Indirect Costs	4,585,874	5,585,537	999,663
Total Direct Costs	16,537,140	30,258,828	13,721,688
Total Loaded Costs	21,123,014	35,844,365	14,721,351

D. Disallowance

There is no disallowance calculation for the Supply Line 43-121 South Replacement Project as there were no post-1955 segments included in the Project without records that provide the minimum information to demonstrate compliance with then applicable industry standards or regulatory strength testing and recordkeeping requirements.

Pipeline Safety Enhancement Plan Final Report
Supply Line 43-121 South Replacement Project

V. CONCLUSION

SoCalGas and SDG&E enhanced the safety of their integrated natural gas transmission system by prudently executing the Supply Line 43-121 South Replacement Project. Through this Replacement Project, SoCalGas and SDG&E successfully replaced 1.477 miles of pipeline and installed two mainline valves and bridle assemblies in the City of Los Angeles. The total loaded cost of the Project is \$35,844,365.

SoCalGas and SDG&E executed this project prudently by splitting the Project into multiple sections to avoid costly and prolonged customer outages, and by verifying field conditions before and during design to incorporate any known issues before construction.

SoCalGas and SDG&E engaged in prudent cost avoidance efforts by revising the design during construction to open cut, removing the use of stopples, and designing an isolation plan that utilized existing valves.

End of Supply Line 43-121 South Final Report

Pipeline Safety Enhancement Plan Final Report
Supply Line 44-137 Replacement Project

I. SUPPLY LINE 44-137 REPLACEMENT PROJECT

A. Background and Summary

Supply Line 44-137 is a [REDACTED] diameter transmission line in a residential area that runs approximately one mile from Garvey Avenue and Santa Anita Avenue to El Monte Busway (MTA Way) and [REDACTED] in the City of El Monte. The pipeline is primarily routed across a Class 3 location. This report describes the activities associated with the Supply Line 44-137 Replacement Project that consists of the replacement of 1.039 miles of pipeline and bridle assembly valves. The specific attributes of this Project are detailed in Table 1 below. The total loaded cost of the Project is \$27,620,871.

Table 1: General Project Information

Project Name	Supply Line 44-137		
Project Type	Replacement		
Original Length	1.039 miles		
Location	City of El Monte, South El Monte		
Class	3		
MAOP (<i>confidential</i>)	[REDACTED]		
Pipe Vintage	1950		
Construction Start	11/03/2014		
Construction Finish	02/29/2016		
Original Pipe Diameter (<i>confidential</i>)	[REDACTED]		
New Diameter (<i>confidential</i>)	[REDACTED]		
Original SMYS ¹ (<i>confidential</i>)	[REDACTED]		
New SMYS (<i>confidential</i>)	[REDACTED]		
Project Costs (\$)	Capital	O&M	Total
Loaded Project Costs	27,604,726	16,145	27,620,871
Disallowed Costs	-	-	-

¹ Highest percentage Specified Minimum Yield Strength (SMYS) of Category 4 Criteria pipe.

Pipeline Safety Enhancement Plan Final Report
Supply Line 44-137 Replacement Project

B. Maps and Images

Figure 1: Satellite Image of Supply Line 44-137 Replacement Project

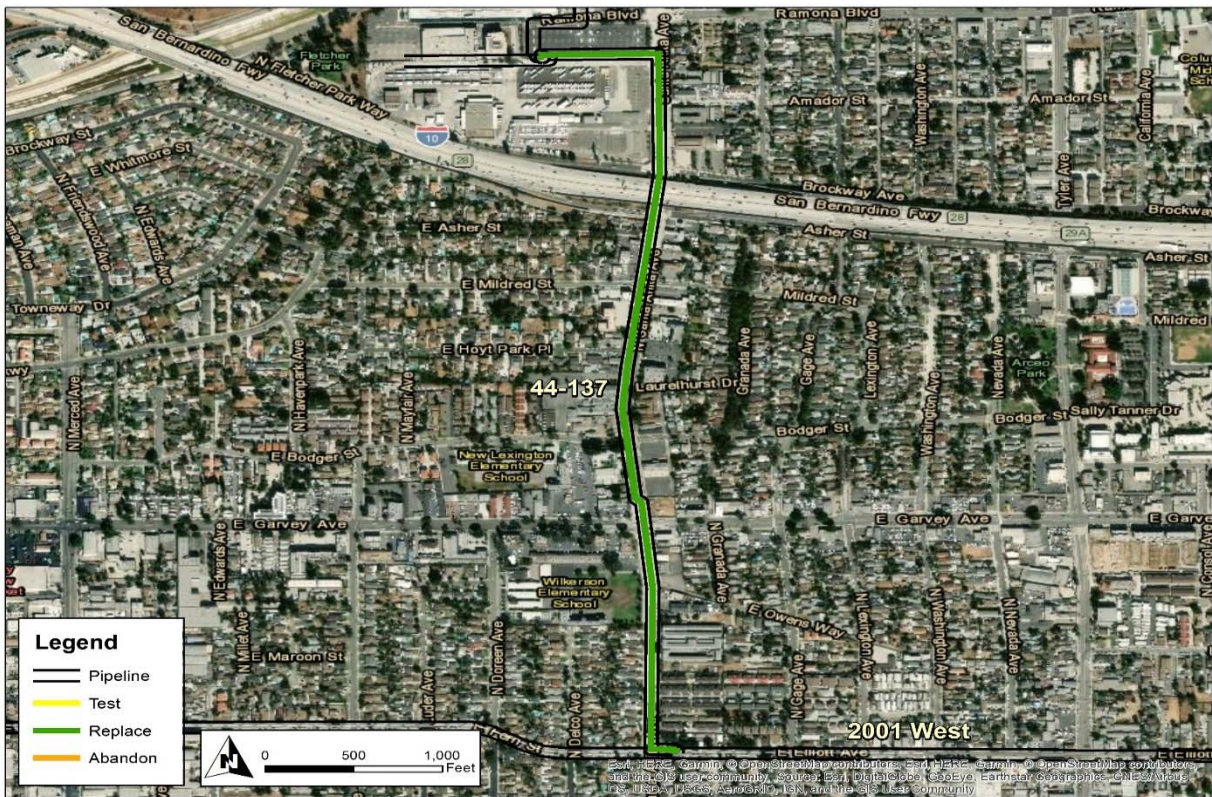

Pipeline Safety Enhancement Plan Final Report Supply Line 44-137 Replacement Project

Figure 2: Overview Map of Supply Line 44-137 Replacement Project



Pipeline Safety Enhancement Plan Final Report
Supply Line 44-137 Replacement Project

II. ENGINEERING, DESIGN, AND PLANNING

A. Project Scope

Table 2: Mileage Information

	Criteria	Accelerated	Incidental	New	Total ²
Final Mileage	1.003 mi.	0 mi.	0.020 mi.	0.016 mi.	1.039 mi.
	5,298 ft.	0 ft.	105 ft.	84 ft.	5,486 ft.

SoCalGas and SDG&E presented a conceptual project scope in workpapers supporting the 2011 PSEP filing.³ Prior to initiating execution of the Project in 2014, SoCalGas and SDG&E reviewed existing pipeline records to validate the scope of the Project. During the Engineering, Design, and Planning phase, SoCalGas and SDG&E further refined the scope. This progression of the project scope is summarized as follows:

- 2011 PSEP Filing: SoCalGas and SDG&E identified Supply Line 44-137 as a Phase 1A Replacement Project comprised of 0.996 miles of Category 4 Criteria pipe and 0.007 miles of Accelerated pipe.
- Scope Validation: Through scope validation activities, after the 2011 filing and before initiating execution of the Project, SoCalGas and SDG&E successfully reduced the project scope by 0.053 miles of Category 4 Criteria pipe and 0.007 miles of Accelerated pipe.
- Engineering, Design, and Constructability: SoCalGas and SDG&E routed the pipeline alignment around existing utilities and substructures, adding 84 feet of New pipe to the project scope.

² Values may not add to total due to rounding.

³ See Amended PSEP of SoCalGas and SDG&E, submitted December 2, 2011, in R.11-02-019 and subsequently transferred to A.11-11-002.

Pipeline Safety Enhancement Plan Final Report
Supply Line 44-137 Replacement Project

4. Final Project Scope: The final project scope consists of a 1.039 mile Replacement and the installation of a new bridle assembly.

B. Decision Tree Analysis

SoCalGas and SDG&E performed a PSEP Decision Tree analysis of Supply Line 44-137 and initially confirmed the project design should commence as a Hydrotest Project.

For pipeline segments longer than 1,000 feet in length, under the approved PSEP Decision Tree, SoCalGas and SDG&E complete a preliminary review to determine whether SoCalGas and SDG&E can manage customer service impacts if the pipeline segment is taken out of service for a period of two to six weeks to complete pressure testing. Where mitigation of customer impacts to remove the line from service for pressure testing is feasible, SoCalGas and SDG&E compare the costs, constructability, risks, and benefits of pressure testing and replacement to determine whether pressure testing or replacement is the more prudent option.

However, through this Decision Tree analysis, SoCalGas and SDG&E identified Replacement as the more prudent option. Key considerations that support SoCalGas and SDG&E's determination to replace this segment include:

1. Shut-In Analysis: The Project Team completed a Request for Engineering Review (RER) analysis and concluded that the line could be shut-in between spring and fall conditions, provided ██████ is fed with compressed natural gas (CNG) or liquified natural gas (LNG) for the duration of the shut-in.

Pipeline Safety Enhancement Plan Final Report
Supply Line 44-137 Replacement Project

2. Customer Impact: The reliability of temporary service to [REDACTED] was uncertain regarding whether the LNG equipment could sustain the constant start and stop of the unstable demand. Additionally, [REDACTED] fueling requirements would require cryogenic pumps and vaporizers as part of the LNG equipment. These LNG conditions posed significant risk to the [REDACTED] fueling requirements.

Upon receiving final quotes for the LNG vendors, the estimated hydrotest project cost exceeded the estimated replacement cost because the cost for the LNG for the bus fueling terminal increased significantly from the original quote (from \$750,000 to \$3.2 million). The high cost of LNG supported the decision to change the scope of the Project to a replacement.

3. Community Impacts: The replacement location would affect several busy intersections along the alignment, including the entrance to the bus terminal at the north side of the project site.
4. Permit Conditions: No identified issues.
5. Piggability: Non-piggable.
6. Pipe Vintage: 1950.
7. Existing Pipe Attributes: Known locations of pipe wall loss between 20% and 80% of the nominal wall thickness.
8. Longseam Type: Unknown.
9. Longseam Repair History: No identified issues.
10. Condition of Coating: Known locations of coating disbanding and significant degradation with large or numerous holidays.

Pipeline Safety Enhancement Plan Final Report
Supply Line 44-137 Replacement Project

11. History of Leaks: No identified issues.

12. Constructability: No identified issues.

C. Engineering, Design, and Planning Factors

SoCalGas and SDG&E reviewed pipeline drawings and other information, contacted internal planning groups, communicated with external stakeholders, conducted survey activities, including reviewing public records and potholing of the area to confirm the presence of underground utilities and substructures, and completed a pre-design site walk. Key factors that influenced the engineering and design of the Project are as follows:

1. Shut-In Analysis: As discussed above, the Project Team completed an RER analysis and concluded that the system could sustain a shut-in of Supply Line 44-137 between spring and fall conditions provided [REDACTED] was fed through CNG or LNG. The Project Team determined this was not feasible.
2. Tie-In: The Project Team initially planned for isolation of the line utilizing [REDACTED] stopple fittings with bypasses to accommodate a tie-in.
3. Diameter Changes: The original existing pipeline had a [REDACTED] diameter. SoCalGas and SDG&E analyzed typical load demands and future capacity planning for a replacement diameter of [REDACTED] and determined it would be sufficient.
4. Constructability: The Project Team engineered and designed a majority of the replacement as open-cut trench installation, with the exception of two slick bores at the intersections of Garvey Avenue and Interstate 10 Freeway with North Santa Anita Avenue. The bore at Garvey Avenue, approximately 143 feet in length, was required to install the replacement pipe beneath an existing culvert.

Pipeline Safety Enhancement Plan Final Report
Supply Line 44-137 Replacement Project

The bore at the Interstate 10 Freeway, approximately 440 feet in length, was required as part of Caltrans permit conditions. Caltrans preferred a bored pipe installation over open-cut trench, with the bore pits located outside their right of way (ROW). Caltrans preferred this method because it minimizes soil disturbance and possible integrity issues around their assets; in this case, the substructure and foundations for the Interstate 10 Freeway overpass.

5. Environmental: An environmental review of the replacement route located environmental sensitive areas (ESA) present on the replacement route. Agency coordination, compliance review, and field surveys determined no additional permits, nor additional environmental provisions were required for construction.
6. Valves: Through analysis of typical load demand and future capacity planning, the design level of the pipeline required seven new higher rated flange valves, consisting of two mainline valves (MLVs) and five other bridles or tap valves.
7. Taps: The Project identified one [REDACTED] service tap in the RER for shut-in. The design included tie-in of the tap to the replacement pipe utilizing a pressure control fitting (PCF) with a bottom out connection and demolition of the existing tap connection. The Project Team designed and planned the PCF so there would be no service interruption. The PCF with the bottom out connection allowed for the Project Team to put the new pipe in service prior to taking the old tap connection out of service.

Pipeline Safety Enhancement Plan Final Report
Supply Line 44-137 Replacement Project

D. Scope Changes

Through engineering, design, and planning activities, SoCalGas and SDG&E determined that changes in scope were appropriate to enhance the design of the Project and address engineering factors. As a result, the preliminary cost estimate does not fully reflect the final scope. Summarized below are notable changes in scope made after the preliminary cost estimate was developed and approved.

1. Due to requirements from the City of El Monte and permit conditions for addressing traffic impacts to a nearby school, the Project Team changed the Bodger Street crossing, approximately 120 feet, from an open-cut trench to a slick bore construction. The Project Team designed the bore pits outside the limits of both intersections as to not impede traffic to and from the school.
2. When [REDACTED] and the City of El Monte learned of the proposed slick bore across Caltrans' ROW under the Interstate 10 Freeway overpass, they greatly opposed the design, since the bore pits were in traffic lanes and would have a construction duration that would significantly impact vehicular traffic and bus traffic to and from [REDACTED]. [REDACTED] and City of El Monte refused to support the slick bore construction method. For this reason, the Project Team altered the design to open-cut trench installation through Caltrans' ROW and revised their permit package accordingly and resubmitted it to Caltrans. The Project Team worked with Caltrans for eight months to get the permit approved as an open-cut trench. A traffic statistic report and support of [REDACTED] and City of El Monte persuaded Caltrans to approve the requested open-cut installation. This report made a case for the difference in duration and traffic impact for each installation method; bore (five to seven weeks) versus open-cut bore (no impact to peak traffic, night work only). Caltrans ultimately approved the permit allowing for open-cut trench as night work only.

Pipeline Safety Enhancement Plan Final Report
Supply Line 44-137 Replacement Project

3. The City of El Monte permit conditions stated, “removal and replacement of the plain cement concrete (PCC) street sections shall be from panel to panel.”, so the permit required replacement of an entire panel (approximately 25 feet by 10 feet and others varying in dimension) rather than just concrete restoration of the trench width used for installation of the pipe. Approximately 0.303 miles of the replacement alignment along Santa Anita Avenue from Mildred Street to Elliott Avenue required restoration of these concrete road panels.

Pipeline Safety Enhancement Plan Final Report
Supply Line 44-137 Replacement Project

III. CONSTRUCTION

A. Construction Contractor Selection

The Project Team prepared an initial cost estimate based on the preliminary design. Following completion of the engineering, design, and planning activities described above, SoCalGas and SDG&E entered into a competitive bidding process to select a construction contractor, that included the updated design described in the discussion of notable Scope Changes above. SoCalGas and SDG&E awarded the construction contract to the bidder that best met the selection criteria for this project.

1. SoCalGas and SDG&E’s Preliminary Construction Cost Estimate (*confidential*):
SoCalGas and SDG&E’s preliminary cost estimate for construction was [REDACTED].
2. Construction Contractor’s Bid (*confidential*): The Construction Contractor’s bid was [REDACTED], which was [REDACTED] than SoCalGas and SDG&E’s preliminary cost estimate for construction.

B. Construction Schedule

Table 3: Construction Timeline

Construction Start Date	11/03/2014
Construction Completion Date	02/29/2016
NOP Date	12/03/2015

C. Changes During Construction

The conditions summarized below were encountered during construction. Activities to address or mitigate these conditions resulted in approximately \$3,485,000 in change orders.

Pipeline Safety Enhancement Plan Final Report
Supply Line 44-137 Replacement Project

1. Field Design Change:

- a. After a field meeting with [REDACTED] the Project Team was made aware that the replacement design alignment was in conflict with a future [REDACTED] parking structure planned for the [REDACTED] parking lot. To avoid this conflict, the Project Team relocated the alignment outside the limits of the planned parking structure site, further north in the parking lot, and closer to the fence line. This new location necessitated the removal of approximately 500 feet of existing Supply Line 44-137 and approximately 1,000 feet of two medium pressure pipelines that were connected to a regulator station in the [REDACTED] parking lot. These two pipelines were replaced with new lines that were installed parallel to the replacement alignment of this project. This design change also required installation of a fire control valve, riser, and branch connection at the regulator station that feeds the [REDACTED] compressors. This new location also required removal and replacement of trees, landscape, and a drip irrigation system. This field design change and resulting impacts delayed the construction schedule and produced additional costs.

- b. As referenced in Table 4 below, the original plan to install pipe across the intersection of Santa Anita Avenue and MTA Way was by methods of open-cut trench. [REDACTED] asserted that this construction method would be detrimental to bus traffic entering and exiting the station. The alignment that crossed MTA Way was redesigned to a shallow horizontal directional drill (HDD), with a minimum depth of cover comparable to open-cut trench installation and low entry angle relative to conventional HDD designs, minimizing the traffic impact. [REDACTED] agreed with the shallow HDD alternative.

Pipeline Safety Enhancement Plan Final Report
Supply Line 44-137 Replacement Project

The Project Team implemented additional traffic control measures, including flaggers and message boards, to prevent disruption of bus traffic coming into and out of the station entrance on MTA Way. This field design change and resulting traffic control and shuttle services produced additional traffic control costs.

Table 4: Engineered Crossing Design Changes

	MTA Way	I-10 Freeway	Garvey Ave	Bodger St
Preliminary Estimate Design	Open-cut	Slick bore	Slick bore	Open-cut
TPE Design	Open-cut	Open-cut	Slick bore	Slick bore
Actual Installation Method	Shallow HDD	Open-cut	Slick bore	Slick bore

2. Gas Handling: Due to isolation complications from an adjacent SoCalGas and SDG&E Non-PSEP project, the south MLV planned for the replacement tie-in isolation was unavailable. As a result, the isolation plan required additional analysis to identify alternative gas flow and potential customer impacts. During this duration, the Construction Contractor was on stand-by for 28 days.
3. Schedule Delay: The Project Team extended the construction schedule multiple times due to field design changes and permit delays related to the City of El Monte, County of Los Angeles, [REDACTED], and Caltrans.
4. Substructures: The Construction Contractor found an unidentified storm drain in conflict with the south tie-in design alignment at Elliott Avenue. As a result, SoCalGas and SDG&E performed additional exploratory excavations and potholing to determine a suitable alternative alignment relative to the identified storm drain.

Pipeline Safety Enhancement Plan Final Report
Supply Line 44-137 Replacement Project

Due to the high density of adjacent utilities at this location, the alternative alignment required a change from an open-cut trench shoring method to a Beam and Lag Engineered Shoring System, and the excavation of a 25 foot by 16 foot by 10 foot pit. The new alignment and traffic plating allowed the street to remain open to traffic while hydrotest and tie-in operations were performed. These activities delayed the construction schedule and resulted in additional costs.

5. Constructability Issues: During a post-construction quality review, it was determined to repair one girth weld due to identification of porosity within the weld, and to reexamine seven girth welds due to defective x-ray film density. Prior to the quality review, the locations of these eight welds were backfilled, and the street was restored to its previous existing condition. The Project Team located three of these welds beneath concrete road panels and the other five beneath an asphalt road. The Project Team re-excavated all eight welds, re-shored the trenches, and re-radiographed the welds to produce quality film records. This additional work for the weld repair and reexaminations delayed the construction schedule and resulted in additional costs.
6. Site Restoration: As part of the restoration near the Santa Anita Avenue and MTA Way intersection, [REDACTED] requested two new Americans with Disabilities Act (ADA) compliant handicapped pedestrian ramps be installed at the northwest and southwest corners of the intersection. The new sidewalk impacted a four way firewater valve connection.
7. Other: [REDACTED] requested that SoCalGas and SDG&E provide shuttle bus service to safely transport commuters from their south parking lot to the bus terminal during construction. Commuter shuttle services were provided for 42 days.

Pipeline Safety Enhancement Plan Final Report
Supply Line 44-137 Replacement Project

8. Permits Conditions: Delays to the construction schedule increased the cost reimbursement to the City of El Monte Police Department required by the city permit.
9. System Upgrades: As discussed in field design changes, [REDACTED] requested relocation of a medium pressure line that conflicted with the planned development areas. SoCalGas and SDG&E conducted regulator station work during this time period in conjunction with PSEP work to relocate the existing medium pressure away from a future planned development of the areas. This work upgraded the regulator station to a bi-directional station to provide redundancy to the system and customer. The Operating District funded this work.

Pipeline Safety Enhancement Plan Final Report
Supply Line 44-137 Replacement Project

Figure 3: Shallow HDD Pullback Preparation at Santa Anita Avenue and MTA Way

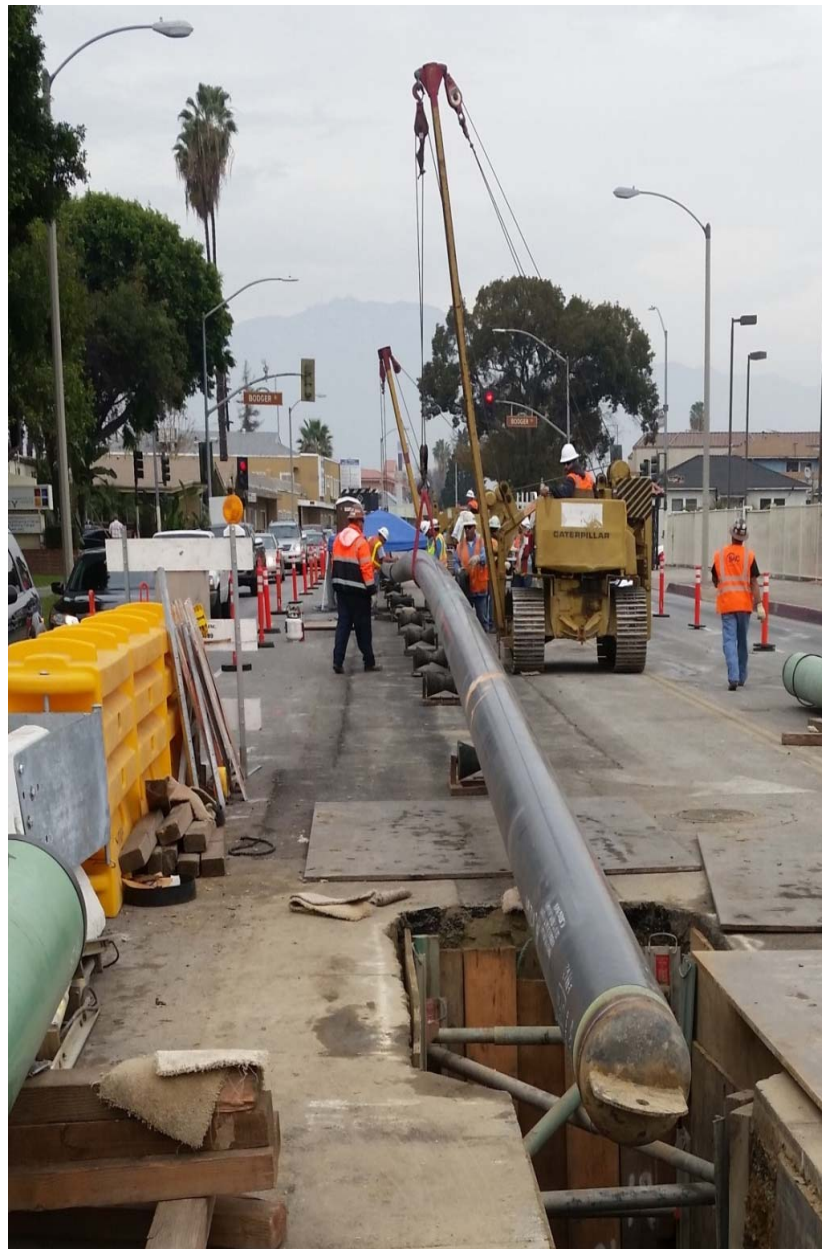

Pipeline Safety Enhancement Plan Final Report
Supply Line 44-137 Replacement Project

D. Commissioning and Site Restoration

Commissioning activities include restoration of the site, final inspection and placement of the pipeline back into service, transportation and disposal of hydrotested water and hazardous material, and site demobilization. Closeout activities include development of final drawings, finalization of a reconciliation package, and updates to company recordkeeping systems to reflect the completed scope of work.

Pipeline Safety Enhancement Plan Final Report
Supply Line 44-137 Replacement Project

IV. PROJECT COSTS

A. Cost Avoidance Actions

SoCalGas and SDG&E exercised due diligence in the planning, design, and construction activities for this project to minimize or avoid costs when prudent to do so. As discussed above, the Project Team conducted a site visit to identify and incorporate discernible site conditions into the engineering, design, and planning of the Project. Specific examples of cost avoidance actions taken on this project are:

1. Engineering and Design: The original existing pipeline had a [REDACTED] diameter. SoCalGas and SDG&E planned a replacement diameter of [REDACTED] through analysis of typical load demands and future capacity. This effort provided a cost savings by avoiding the larger diameter material costs and additional associated construction labor that would have been required for installation and fabrication.
2. Planning and Coordination:
 - a. The Project Team strategically scheduled construction activities to coincide with non-peak [REDACTED] demands and avoid the cost and use of stopples and bypass fittings to accommodate the replacement tie-ins.
 - b. The Project Team changed the alignment of the new line after discussions with [REDACTED] regarding future improvements to the site location that would have required the line to be moved once those improvements began, successfully avoiding another mobilization, demobilization, shut-in, and other related construction costs. SoCalGas and SDG&E redesigned the regulator station and feed connection to [REDACTED] at this time in order to improve the system reliability.

Pipeline Safety Enhancement Plan Final Report
Supply Line 44-137 Replacement Project

Cost Estimates

Based on the preliminary design, once the project scope was confirmed and engineering, design, and planning activities were underway, SoCalGas and SDG&E prepared an estimate of the Direct Costs of the Project in the amount of \$9,081,074. This estimate was prepared in July of 2014, using the “SCG Pipeline Estimate Template Rev 0” estimating tool, the most current version of the PSEP Estimate Template at the time. The Project Team considered the conditions known at the time to prepare the preliminary Direct Cost estimate. This estimate reflects the projected Labor, Material and Services costs anticipated to be incurred to execute the Project.

SoCalGas and SDG&E estimated Indirect Costs of the Project based on the estimated Direct Costs and other project related variables.

B. Actual Direct and Indirect Costs

Actual Direct Costs reflect the Labor, Material, and Service costs incurred to execute the Project. Actual Indirect Costs reflect costs for incremental overhead loaders in accordance with Company overhead allocation policies. The total loaded cost of the Project is \$27,620,871.

Pipeline Safety Enhancement Plan Final Report
Supply Line 44-137 Replacement Project

Table 5: Estimated and Actual Direct Costs and Variances

Direct Costs (\$)	Estimate	Actuals	Delta Over/(Under)
Company Labor	385,833	405,536	19,703
Materials	811,236	491,032	(320,204)
Construction Contractor	4,187,612	11,716,962	7,529,350
Construction Management & Support	725,505	2,802,974	2,077,469
Environmental	140,800	461,825	321,025
Engineering & Design	1,027,001	3,030,220	2,003,219
Project Management & Services	778,399	2,308,497	1,530,098
ROW & Permits	64,900	456,783	391,883
GMA	959,788	2,841,805	1,882,017
Total Direct Costs	9,081,074	24,515,634	15,434,560

Table 6: Estimated and Actual Indirect Costs, Total Costs and Variances

Indirect Costs / Total Costs (\$)	Estimate	Actuals	Delta Over/(Under)
Overheads	800,277	1,841,987	1,041,710
AFUDC	1,224,627	1,114,558	(110,069)
Property Taxes	240,035	148,692	(91,343)
Total Indirect Costs	2,264,939	3,105,237	840,298
Total Direct Costs	9,081,074	24,515,634	15,434,560
Total Loaded Costs	11,346,013	27,620,871	16,274,858

C. Disallowances

There was no disallowance for Supply Line 44-137 as there were no post-1955 segments included in the Project without records that provide the minimum information to demonstrate compliance with then applicable industry standards or regulatory strength testing and recordkeeping requirements

Pipeline Safety Enhancement Plan Final Report
Supply Line 44-137 Replacement Project

V. CONCLUSION

SoCalGas and SDG&E enhanced the safety of their integrated natural gas transmission system by prudently executing the Supply Line 44-137 Replacement Project. Through this replacement project, SoCalGas and SDG&E successfully replaced 1.039 miles of pipe in the Cities of El Monte and South El Monte. The total loaded Project cost is \$27,620,871.

SoCalGas and SDG&E executed this project prudently through using construction methods of open-cut trenching, slick bore, and HDD; routing the alignment for tie-ins and demolishing conflicting abandoned substructures; improving system connectivity through design coordination for new MLVs, and bridle assembly installations at the north and south tie-ins in an effort to accomplish the Commission's directive to complete work as soon as practicable.

SoCalGas and SDG&E engaged in prudent cost avoidance efforts by conducting analyses to determine the most cost effective isolation conditions for tie-ins and replacement pipe diameter selection. SoCalGas also used reasonable efforts to promote competitive and market-based rates for contractor services to achieve a balanced amount of company and contractor resources given the complex scope of work and field design changes.

End of Supply Line 44-137 Replacement Project Final Report

Pipeline Enhancement Safety Plan Final Report
Supply Line 44-687 Replacement Project

I. SUPPLY LINE 44-687 REPLACEMENT PROJECT

A. Background and Summary

Supply Line 44-687 is a [REDACTED] diameter transmission line that runs approximately 0.3 miles along Grangeville Boulevard east of Highway 41, passing through a flat and largely agricultural area in Kings County. The pipeline is routed across a Class 3 location. This report describes the activity associated with the Supply Line 44-687 Replacement Project, which consists of the replacement of 0.303 miles of pipeline and bridle assembly. The specific attributes for this Project are detailed in Table 1 below. The total loaded cost of the Project is \$5,901,175.

Table 1: General Project Information

Project Name		Supply Line 44-687		
Project Type	Replacement			
Length	0.303 miles			
Location	Kings County			
Class	3			
MAOP (<i>confidential</i>)	[REDACTED]			
Pipe Vintage	1946			
Construction Start	09/29/2014			
Construction Finish	10/30/2015			
Original Pipe Diameter (<i>confidential</i>)	[REDACTED]			
New Diameter (<i>confidential</i>)	[REDACTED]			
Original SMYS ¹ (<i>confidential</i>)	[REDACTED]			
New SMYS (<i>confidential</i>)	[REDACTED]			
Project Costs (\$)	Capital	O&M	Total	
Loaded Project Costs	5,891,540	9,635	5,901,175	
Disallowed Costs	-	-	-	

¹ Highest percentage of Specified Minimum Yield Strength (SMYS) of Category 4 Criteria pipe.

Pipeline Enhancement Safety Plan Final Report Supply Line 44-687 Replacement Project

B. Maps and Images

Figure 1: Satellite Image of Supply Line 44-687 Replacement Project

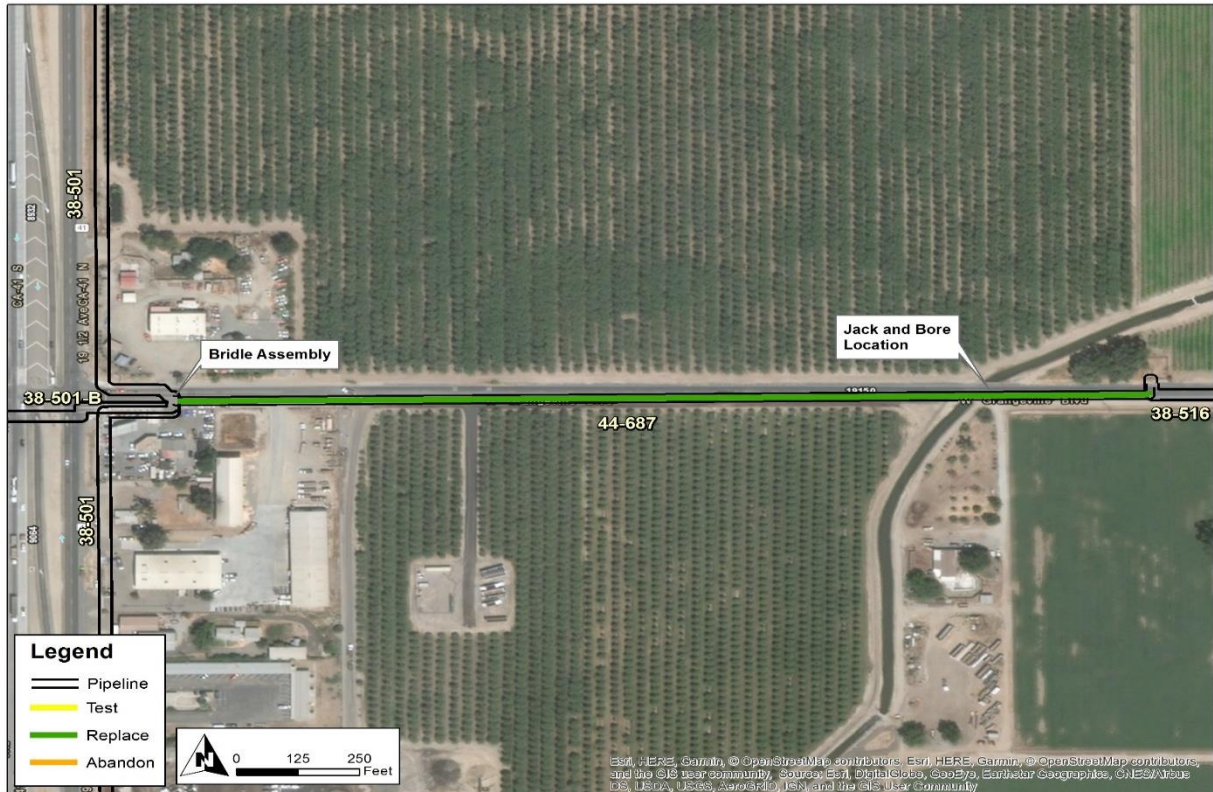

Pipeline Enhancement Safety Plan Final Report Supply Line 44-687 Replacement Project

Figure 2: Overview Map of Supply Line 44-687 Replacement Project

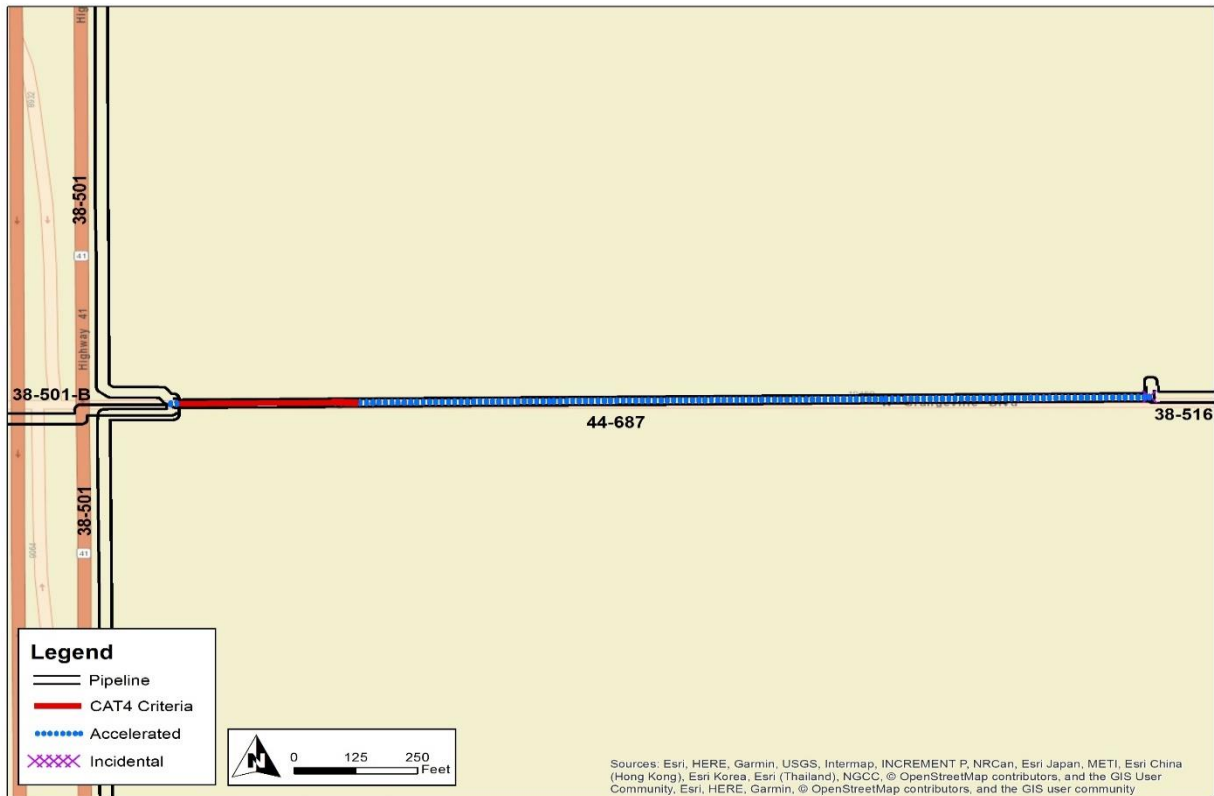

Pipeline Enhancement Safety Plan Final Report
Supply Line 44-687 Replacement Project

II. ENGINEERING, DESIGN, AND PLANNING

A. Project Scope

Table 2: Mileage Information²

	Criteria	Accelerated ³	Incidental	New	Total ⁴
Final Mileage	0.056 mi.	0.244 mi.	0.002 mi.	0.001 mi.	0.303 mi.
	296 ft.	1,288 ft.	13 ft.	4 ft.	1,600 ft.

SoCalGas and SDG&E presented a conceptual project scope in workpapers supporting the 2011 PSEP filing.⁵ Prior to initiating execution of the Project in 2014, SoCalGas and SDG&E reviewed existing pipeline records to validate the scope of the Project. During the Engineering, Design, and Planning phase, SoCalGas and SDG&E further refined the scope. This progression of the project scope is summarized as follows:

1. 2011 PSEP Filing: SoCalGas and SDG&E identified Supply Line 44-687 as a Phase 1A Replacement Project comprised of approximately 290 feet of Category 4 Criteria pipe and 898 feet of Accelerated pipe.
2. Scope Validation: Through scope validation activities, after the 2011 filing and before initiating execution of the Project, SoCalGas and SDG&E increased the scope of this project to include an additional 296 feet of Category 4 Criteria pipe, and identified an additional 427 feet of Accelerated pipe, and 13 feet of Incidental pipe.

² Total mileage of the completed project differs from the mileage of the pipe addressed due to realignment of the pipeline route.

³ Accelerated mileage includes Phase 2A. Phase 2A includes pipelines without sufficient record of a pressure test in less populated areas. The Accelerated mileage was included to realize efficiencies and to enhance project constructability.

⁴ Values may not add to total due to rounding.

⁵ See Amended PSEP of SoCalGas and SDG&E, submitted December 2, 2011, in R.11-02-019 and subsequently transferred to A.11-11-002.

Pipeline Enhancement Safety Plan Final Report
Supply Line 44-687 Replacement Project

3. Engineering, Design, and Constructability:

- a. Due to the complexities of the Grangeville Boulevard and Highway 41 (west) tie-in configuration, SoCalGas and SDG&E deferred replacement of 13 feet of Accelerated pipe to the Supply Line 38-501 Section 2 Replacement Project. The west tie-in configuration included installation of a bridle assembly that includes three ball valves to replace the existing bridle containing Category 4 Criteria pipe on Supply Line 38-501 and Accelerated pipe on Supply Line 44-687. The new bridle design at the west end will also accommodate future tie-ins to the Supply Line 38-501 Section 2 Replacement Project due to the inability to shut-in Supply Line 38-501, reducing the cost of the future tie-in.
- b. SoCalGas and SDG&E maximized efficiencies by addressing 0.244 miles of Accelerated Phase 2 pipe while the pipeline was taken out of service, and thereby eliminated the need for a future Phase 2 project, along with the associated costs and community impacts.
- c. The Project Team included Incidental mileage to tie in beyond the Accelerated mileage.

4. Final Project Scope: The final project scope consists of a 0.303 mile Replacement and a valve bridle assembly. The Accelerated mileage consists of 0.244 miles of Phase 2A pipe and 13 feet of Incidental pipe.

Pipeline Enhancement Safety Plan Final Report Supply Line 44-687 Replacement Project

Figure 3: Schematic of Supply Line 44-687 West Tie-In

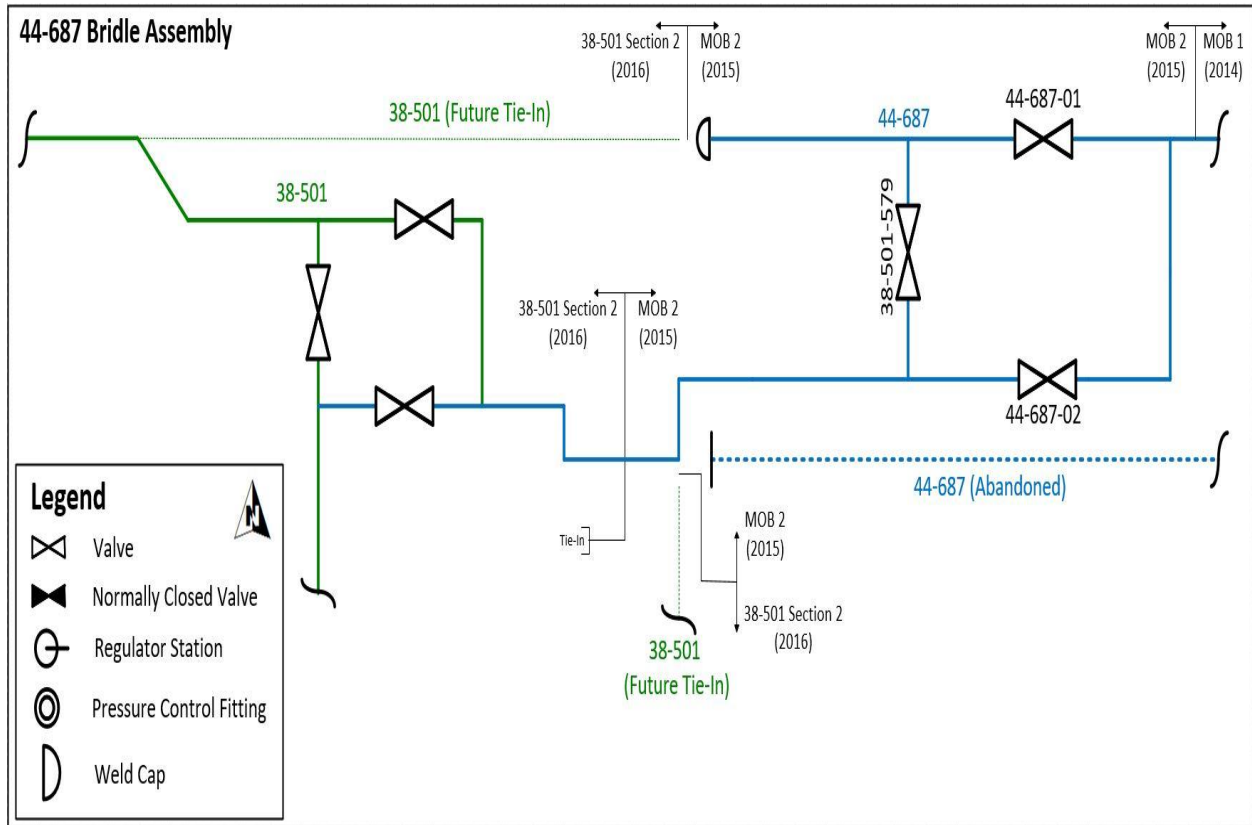

Pipeline Enhancement Safety Plan Final Report
Supply Line 44-687 Replacement Project

B. Decision Tree Analysis

SoCalGas and SDG&E performed a PSEP Decision Tree analysis of Supply Line 44-687 and confirmed the project design should commence as a Replacement Project.

For pipeline segments longer than 1,000 feet in length, under the approved PSEP Decision Tree, SoCalGas and SDG&E complete a preliminary review to determine whether SoCalGas and SDG&E can manage customer service impacts if the pipeline segment is taken out of service for a period of two to six weeks to complete pressure testing. Where mitigation of customer impacts to remove the line from service for pressure testing is feasible, SoCalGas and SDG&E compare the costs, constructability, risks, and benefits of pressure testing and replacement to determine whether pressure testing or replacement is the more prudent option.

Through this Decision Tree analysis, SoCalGas and SDG&E identified replacement as the more prudent option. Key considerations that support SoCalGas and SDG&E's determination to replace this segment include:

1. Shut-In Analysis: The Project Team completed a Request for Engineering Review (RER) analysis and concluded the existing line can be shut in, but only during summer conditions. The analysis determined a shut-in during spring, fall, and winter conditions was unsustainable for reliable customer service without supplying temporary service. The analysis also identified two taps that would require temporary service during the tap tie-over.
2. Customer Impact: Per the RER, this Supply Line 44-687 provides service to residential customers.
3. Community Impacts: No identified issues.

Pipeline Enhancement Safety Plan Final Report
Supply Line 44-687 Replacement Project

4. Permit Conditions: No identified issues.
5. Piggability: Non-piggable.
6. Pipe Vintage: 1946.
7. Existing Pipe Attributes: Features on the line limited piggability.
8. Long Seam Type: Unknown.
9. Long Seam Repair History: No identified issues.
10. Condition of Coating: No identified issues.
11. History of Leaks: No identified issues.
12. Other Identified Risks: Based on engineering judgment and operational experience, the cumulative costs, burdens and risks associated with taking the line out of service to pressure test were higher than those of replacing the segment with new pipe. Moreover, new lines can have structural advantages compared to earlier vintage lines that improve the overall quality and extend the life of the pipeline asset; as such, replacement of a pipe may reduce expenditures incurred and presented in a future regulatory proceeding.

C. Engineering, Design, and Planning Factors

SoCalGas and SDG&E reviewed pipeline drawings and other information, contacted internal planning groups, communicated with external stakeholders, conducted survey activities, including reviewing public records and potholing of the area to confirm the presence of underground utilities and substructures, and completed a pre-design site walk. Key factors that influenced the engineering and design of the Project are as follows:

Pipeline Enhancement Safety Plan Final Report
Supply Line 44-687 Replacement Project

1. Shut-In Analysis: As discussed above, the Project Team completed an RER analysis and concluded that the existing line can be shut in, but only during summer load conditions. The analysis determined a shut-in during spring, fall, and winter load conditions was unsustainable for reliable customer service without supplying temporary service. The analysis also identified two taps that would require temporary service to during tap tie-over.
2. Customer Impact: Per the RER, temporary service would be required to provide temporary support to two customer taps using compressed natural gas (CNG).
3. Diameter Changes: The Project Team replaced the existing [REDACTED] line with a [REDACTED] line to standardize the pipeline for future piggability purposes and take advantage of cost savings from favorable pricing of bulk purchased pipe.
4. Schedule Coordination: The Project Team coordinated construction schedules between two adjacent projects, Supply Line 38-512 Replacement Project and Supply Line 38-501 Section 1 Replacement Project in order to share a laydown yard.
5. Known Substructures: To address crossing an irrigation canal owned by the Lemoore Canal and Irrigation Company, the Project Team designed and engineered a jack and bore installation.
6. Valves: The Project Team designed a new three valve bridle installation to accommodate the future removal of the existing bridle and to better accommodate a future tie-into Supply Line 38-501.
7. Land Use: The Project Team verified that the alignment could be placed within street right of way (ROW) in the dirt shoulder of Grangeville Boulevard.

Pipeline Enhancement Safety Plan Final Report
Supply Line 44-687 Replacement Project

D. Scope Changes

Through engineering, design, and planning activities, SoCalGas and SDG&E determined that changes in scope were appropriate to enhance the design of the Project and address engineering factors. As a result, the preliminary cost estimate does not fully reflect the final scope. Summarized below are notable changes in scope made after the preliminary cost estimate was developed and approved.

1. Construction Schedule: The Project Team modified the design into two construction phases to achieve the goal of project execution as soon as practicable, coordinated with the design for Supply Line 38-501 Section 2 Replacement Project for the west end tie-in, and addressed permit complications and constraints with Caltrans and Kings County for the west end tie-in.
 - a. Phase 1 consisted of installation of 1,515 feet of replacement pipe, and Phase 2 consisted of preparing the two customer taps for temporary CNG service, hydrotesting the replacement pipe, installation of the valves and bridle assembly at west end, tie-ins replacement, and abandonment of original pipeline.
 - b. The Project Team encountered conflicting traffic control requirements between Caltrans and Kings County at the west tie-in location. By phasing the projects, the Project Team alleviated the concerns of Kings County regarding traffic control.
2. Constructability: The Project Team coordinated design efforts with the Supply Line 38-501 Section 2 Replacement Project to include installation of the new bridle at the west End tie-in with the Phase 2 of Supply Line 44-687 Replacement Project. This reduced the overall risk to construction by locating the future Supply Line 38-501 tie-in in a safer location and accommodated requirements for Supply Line 38-501 shut-in restrictions.

Pipeline Enhancement Safety Plan Final Report
Supply Line 44-687 Replacement Project

3. Customer Impact:

- a. The Project Team revised the west tie-in to include a new [REDACTED] mainline valve (MLV) and bridle assembly connection to the existing Supply Line 38-501. This design change was required in order to maintain gas service during the subsequent tie-in of the Supply Line 38-501 Section 2 Replacement Project.
- b. Prior to construction and to mitigate the impact of construction to a local property, SoCalGas and SDG&E constructed a temporary driveway for the property owner to maintain uninterrupted access to their property.

Pipeline Enhancement Safety Plan Final Report
Supply Line 44-687 Replacement Project

III. CONSTRUCTION

A. Construction Contractor Selection

The Project Team prepared an initial cost estimate based on the preliminary design. Following completion of the engineering, design, and planning activities described above, the Project Team directed the Performance Partner to prepare cost estimates based on a more detailed engineering design package, which included the updated design described in the discussion of notable Scope Changes above. SoCalGas and SDG&E awarded the construction contract to the Performance Partner.

1. SoCalGas and SDG&E’s Preliminary Construction Cost Estimate (*confidential*):
SoCalGas and SDG&E’s preliminary cost estimate for construction was [REDACTED].
2. Construction Contractor’s Target Price Estimate (*confidential*): The Construction Contractor’s cost estimate was [REDACTED], which was [REDACTED] than SoCalGas and SDG&E’s preliminary cost estimate for construction.

B. Construction Schedule

Table 3: Construction Timeline

Construction Start Date	09/29/2014
Construction Completion Date	10/30/2015
NOP Date	10/07/2015

C. Changes During Construction

The conditions summarized below were encountered during construction. Activities to address or mitigate these conditions resulted in approximately \$206,000 in change orders.

Pipeline Enhancement Safety Plan Final Report Supply Line 44-687 Replacement Project

1. Traffic: Although the permit called for a full lane closure on Grangeville Boulevard, after construction started, the county inspector did not allow the closure. The Project Team modified the traffic plan to allow for through traffic on Grangeville Boulevard, that limited construction productivity.
2. Other: In anticipation of a future PSEP project that would install a pressure control fitting (PCF) on Supply Line 38-501, SoCalGas and SDG&E requested the Construction Contractor to perform additional bell hole excavations in the construction area to verify the pipeline condition. This provided a future cost savings by eliminating a separate mobilization and obtaining additional permits in the same location to perform potholing activities.
3. Substructure: The Project Team identified an unmarked abandoned vault at the west tie-in location that required demolition prior to the installation of a new valve.
4. Environmental: The unmarked abandoned vault required asbestos abatement for pipe wrap containing asbestos.

Pipeline Enhancement Safety Plan Final Report
Supply Line 44-687 Replacement Project

Figure 4: Test Head Assembly During Hydrotest Operations



Pipeline Enhancement Safety Plan Final Report
Supply Line 44-687 Replacement Project

D. Commissioning and Site Restoration

Commissioning activities include restoration of the site, final inspection and placement of the pipeline back into service, transportation and disposal of hydrotested water and hazardous material, and site demobilization. Closeout activities include development of final drawings, finalization of a reconciliation package, and updates to company recordkeeping systems to reflect the completed scope of work.

Pipeline Enhancement Safety Plan Final Report
Supply Line 44-687 Replacement Project

IV. PROJECT COSTS

A. Cost Avoidance Actions

SoCalGas and SDG&E exercised due diligence in the planning, design, and construction activities for this Project to minimize or avoid costs when prudent to do so. As discussed above, the Project Team conducted a site visit to identify and incorporate discernible site conditions into the engineering, design, and planning of the Project. Specific examples of cost avoidance actions taken on this Project are:

1. Planning and Coordination: The Project Team coordinated construction schedules among three PSEP projects, Supply Line 44-687, Supply Line 38-512, and Supply Line 38-501 Section 1, to share one laydown yard, avoiding the need to acquire three separate laydown yards.
2. Engineering and Design: The Project Team revised the west tie-in design to include a new [REDACTED] valve and bridle assembly for a connection to Supply Line 38-501. This design change was required to maintain gas service during the tie-in of Supply Line 38-501 Section 2 Replacement Project. This provided cost savings by efficiently incorporating compatible design features for two pipelines, Supply Line 44-687 and Supply Line 38-501, reducing the risk of customer service outages and increasing future operational integrity.
3. Construction Execution: During construction at the west tie-in location, SoCalGas and SDG&E requested three additional bell hole excavations be added to the scope of work. These bell holes were needed to verify the pipeline condition for a PCF installation scheduled for Supply Line 38-501 Section 2 Replacement project. This avoided a second mobilization in the same location to perform necessary investigative work.

Pipeline Enhancement Safety Plan Final Report
Supply Line 44-687 Replacement Project

4. Materials: Bulk ordered pipe provided volume pricing for the [REDACTED] pipe.

B. Cost Estimate

Based on the preliminary design, once the project scope was confirmed and engineering, design, and planning activities were underway, SoCalGas and SDG&E prepared an estimate of the Direct Costs of the Project in the amount of \$1,786,093. This estimate was prepared in June of 2014, using the “SCG Pipeline Estimate Template Rev 0” estimating tool, the most current version of the PSEP Estimate Template at the time. The Project Team considered the conditions known at the time to prepare the preliminary Direct Cost estimate. This estimate reflects the projected Labor, Material, and Services costs anticipated to be incurred to execute the Project

SoCalGas and SDG&E estimated Indirect Costs of the Project based on the estimated Direct Costs and other project-related variables.

C. Actual Direct and Indirect Costs

Actual Direct Costs reflect the Labor, Material, and Services costs incurred to execute the Project. Actual Indirect Costs reflect costs for incremental overhead loaders in accordance with Company overhead allocation policies. The total loaded cost of the Project is \$5,901,175.

Pipeline Enhancement Safety Plan Final Report
Supply Line 44-687 Replacement Project

Table 4: Estimated and Actual Direct Costs and Variances

Direct Costs (\$)	Estimate	Actuals ⁶	Delta Over/(Under)
Company Labor	148,377	165,655	17,278
Materials	213,183	117,529	(95,654)
Construction Contractor	628,079	1,967,259	1,339,180
Construction Management & Support	49,879	854,575	804,696
Environmental	200,332	172,254	(28,078)
Engineering & Design	227,639	938,790	711,151
Project Management & Services	91,556	274,225	182,669
ROW & Permits	70,400	80,723	10,323
GMA	156,648	595,011	438,363
Total Direct Costs	1,786,093	5,166,021	3,379,928

Table 5: Estimated and Actual Indirect Costs, Total Costs and Variances

Indirect Costs/Total Costs (\$)	Estimate	Actuals	Delta Over/(Under)
Overheads	224,356	464,942	240,586
AFUDC	42,498	240,865	198,367
Property Taxes	7,821	29,347	21,526
Total Indirect Costs	274,675	735,154	460,479
Total Direct Costs	1,786,093	5,166,021	3,379,928
Total Loaded Costs	2,060,768	5,901,175	3,840,407

D. Disallowance

There was no disallowance for Supply Line 44-687 as there were no post-1955 segments included in the Project without records that provide the minimum information to demonstrate compliance with then applicable industry standards or regulatory strength testing and recordkeeping requirements.

⁶ Actual Material and Construction Contractor costs to exclude the cost of upsizing the pipe.

Pipeline Enhancement Safety Plan Final Report
Supply Line 44-687 Replacement Project

V. CONCLUSION

SoCalGas and SDG&E enhanced the safety of their integrated natural gas transmission system by prudently executing the Supply Line 44-687 Replacement Project. Through this Replacement Project, SoCalGas and SDG&E successfully replaced 0.303 miles of pipe in Kings County. The total loaded cost of the Project is \$5,901,175.

SoCalGas and SDG&E executed this project prudently through using construction methods of open-cut trenching and jack and bore; routing the alignment for tie-ins and demolishing conflicting abandoned substructures; and improving system connectivity through design coordination with adjacent PSEP projects for new valve and bridle assembly installation at the west tie-in in an effort to accomplish the Commission's directive to complete work as soon as practicable.

SoCalGas and SDG&E engaged in prudent cost avoidance efforts by: bulk ordering materials, reasonable efforts to promote competitive and market-based rates for contractor services, optimized permitted working space by performing investigative excavations for an adjacent PSEP project, reducing mobilization needs in this same location for the adjacent PSEP project, coordinated construction schedules among three PSEP projects to accommodate a shared laydown yard, and used a reasonable amount of company and contractor resources given the complex scope of work (valve bridle assembly installations) and work scope changes (two construction phases due to permit constraints).

End of Supply Line 44-687 Final Report

Pipeline Safety Enhancement Plan Final Report
Supply Line 44-720 Replacement Project

I. SUPPLY LINE 44-720 REPLACEMENT PROJECT

A. Background and Summary

Supply Line 44-720 is a [REDACTED] diameter transmission pipeline that runs approximately one mile crossing under Highway 99, passing through agricultural and residential areas in the City of Tipton. The pipeline is primarily routed across a Class 3 location and traverses some Class 1 locations. This report describes the activity associated with the Supply Line 44-720 Replacement Project, which consists of the replacement of the 1.493 miles of pipeline. The specific attributes for this Project are detailed in Table 1 below. The total loaded cost of the Project is \$10,990,155.

Table 1: General Project Information

Project Name		Supply Line 44-720		
Project Type	Replacement			
Length ¹	1.493 miles			
Location	Tipton			
Class	3			
MAOP (<i>confidential</i>)	[REDACTED]			
Pipe Vintage	1947			
Construction Start	06/22/2015			
Construction Finish	10/09/2015			
Original Pipe Diameter (<i>confidential</i>)	[REDACTED]			
New Diameter (<i>confidential</i>)	[REDACTED]			
Original SMYS ² (<i>confidential</i>)	[REDACTED]			
New SMYS (<i>confidential</i>)	[REDACTED]			
Project Costs (\$)	Capital	O&M	Total	
Loaded Projects Costs	10,980,992	9,163	10,990,155	
Disallowed Costs	-	-	-	

¹ Length includes the mileage from both Supply Line 44-720 and Supply Line 38-539.

² Highest percentage of Specified Minimum Yield Strength (SMYS) of Category 4 Criteria pipe.

Pipeline Safety Enhancement Plan Final Report Supply Line 44-720 Replacement Project

B. Maps and Images

Figure 1: Satellite Image of Supply Line 44-720 Replacement Project

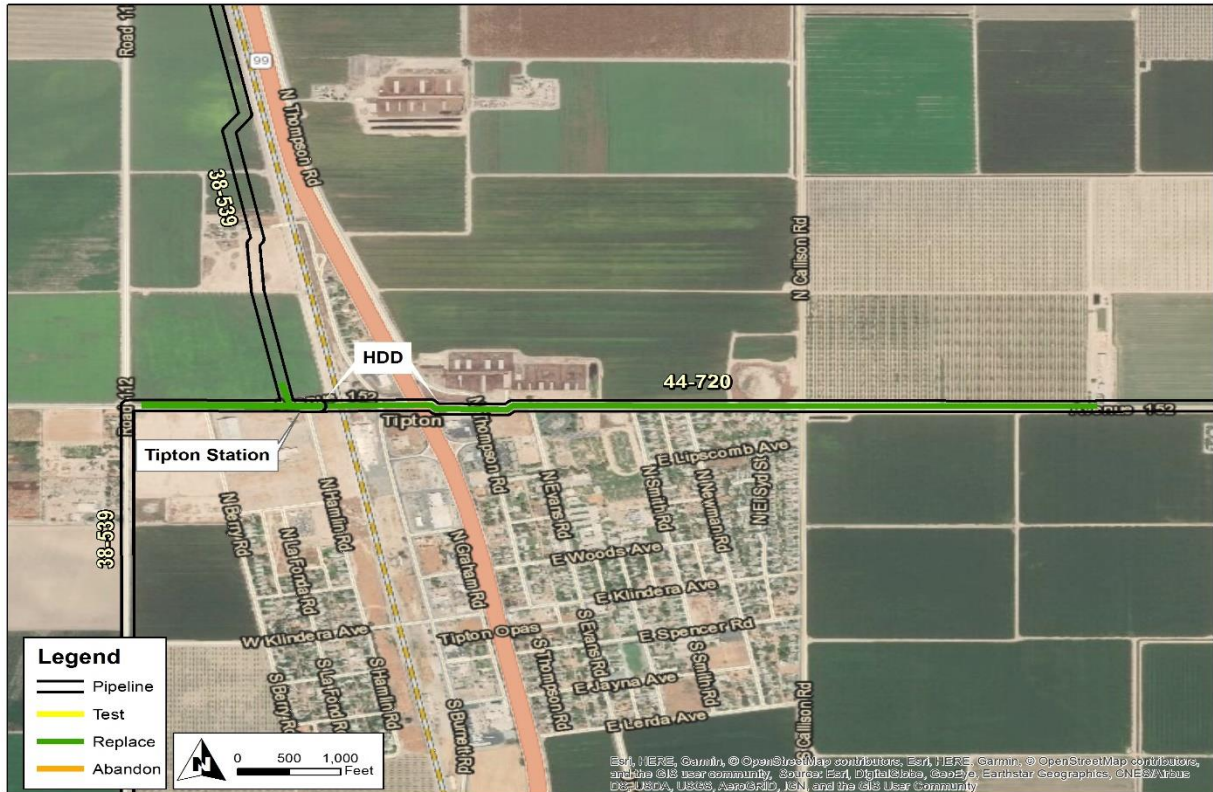

Pipeline Safety Enhancement Plan Final Report Supply Line 44-720 Replacement Project

Figure 2: Overview Map of Supply Line 44-720 Replacement Project



Pipeline Safety Enhancement Plan Final Report
Supply Line 44-720 Replacement Project

II. ENGINEERING, DESIGN, AND PLANNING

A. Project Scope

Table 2: Mileage Information³

	Criteria	Accelerated ⁴	Incidental	New	Total ⁵
SL 44-720	0.703 mi.	0.463 mi.	0.016 mi.	0.066 mi.	1.247 mi.
	3,712 ft.	2,442 ft.	83 ft.	348 ft.	6,585 ft.
SL 38-539	0.023 mi.	0.300 mi.	0.005 mi.	0 mi.	0.246 mi.
	123 ft.	1,585 ft.	25 ft.	0 ft.	1,299 ft.
Total Final Mileage	0.726 mi.	0.763 mi.	0.020 mi.	0 mi.	1.493 mi.
	3,834 ft.	4,027 ft.	108 ft.	0 ft.	7,884 ft.

SoCalGas and SDG&E presented a conceptual project scope in workpapers supporting the 2011 PSEP filing.⁶ Prior to initiating execution of the Project in 2015, SoCalGas and SDG&E reviewed existing pipeline records to validate the scope of the Project. During the Engineering, Design, and Planning phase, SoCalGas and SDG&E further refined the scope. This progression of the project scope is summarized as follows:

1. 2011 PSEP Filing: SoCalGas and SDG&E identified Supply Line 44-720 as a Phase 1A Replacement Project comprised of 0.952 miles of Category 4 Criteria pipe and 0.216 miles of Accelerated pipe.

³ Total mileage of the completed project differs from the mileage of the pipe addressed due to realignment of the pipeline route.

⁴ Accelerated mileage includes Phase 2A and Phase 2B pipe. Phase 2 includes pipelines without sufficient record of a pressure test in less populated areas (Phase 2A) or pipelines with record of a pressure test, but without record of a pressure test to modern – Subpart J – standards (Phase 2B). The Accelerated mileage was included to realize efficiencies and to enhance project constructability.

⁵ Values may not add to total due to rounding.

⁶ See Amended PSEP of SoCalGas and SDG&E, submitted December 2, 2011, in R.11-02-019 and subsequently transferred to A.11-11-002.

Pipeline Safety Enhancement Plan Final Report
Supply Line 44-720 Replacement Project

2. Scope Validation: Through scope validation activities, after the 2011 filing and before initiating execution of the Project, SoCalGas and SDG&E successfully reduced the scope of the Project by 0.225 miles of Category 4 Criteria pipe, and identified an additional 0.546 miles of Accelerated pipe, and 0.021 miles of Incidental pipe.
3. Engineering, Design, and Constructability:
 - a. The Project Team relocated the new west tie-in to the adjacent Supply Line 38-539 to improve the integrity of the system.
 - b. Accelerated pipe was included due to characteristics of the long seam type.
4. Final Project Scope: The final project scope consists of a 1.493 mile Replacement. The Accelerated mileage consists of 0.637 miles of Phase 2A pipe, 664 feet of Phase 2B pipe, and 0.02 miles of Incidental pipe.

B. Decision Tree Analysis

SoCalGas and SDG&E performed a PSEP Decision Tree analysis of Supply Line 44-720 and confirmed the project design should commence as a Replacement Project.

For pipeline segments longer than 1,000 feet in length, under the approved PSEP Decision Tree, SoCalGas and SDG&E complete a preliminary review to determine whether SoCalGas and SDG&E can manage customer service impacts if the pipeline segment is taken out of service for a period of two to six weeks to complete pressure testing. Where mitigation of customer impacts to remove the line from service for pressure testing is feasible, SoCalGas and SDG&E compare the costs, constructability, risks, and benefits of pressure testing and replacement to determine whether pressure testing or replacement is the more prudent option.

Pipeline Safety Enhancement Plan Final Report Supply Line 44-720 Replacement Project

Through this Decision Tree analysis, SoCalGas and SDG&E identified replacement as the more prudent option. Key considerations that support SoCalGas and SDG&E's determination to replace this segment include:

1. Shut-In Analysis: The Project Team completed a Request for Engineering Review (RER) analysis and concluded the system demand was too high to accommodate a shut-in.
2. Customer Impacts: Supply Line 44-720 is the primary feed to two other supply line systems, as well as two Pressure Districts. These systems' demands were too high to be fed by alternative means during a shut-in.
3. Community Impacts: Traffic impacts and occasional noise.
4. Permit Conditions: No identified issues.
5. Piggability: Non-piggable.
6. Predominant Pipe Vintage: 1947.
7. Existing Pipe Attributes: Historical records indicated a long seam failure along a segment of spiral welded pipe. Additionally, testing would have increased the risk due to a known seam failure. Replacement offered several advantages, the primary one being increased system integrity.
8. Long Seam Type: Spiral weld.
9. Long Seam Repair History: Records show failure of long seam.
10. Condition of Coating: No identified issues.
11. History of Leaks: No identified issues.

Pipeline Safety Enhancement Plan Final Report
Supply Line 44-720 Replacement Project

C. Engineering, Design, and Planning Factors

SoCalGas and SDG&E reviewed pipeline drawings, other information, contacted internal planning groups, communicated with external stakeholders, conducted survey activities, including reviewing public records, and potholing of the area to confirm the presence of underground utilities and substructures, and completed a pre-design site walk. Key factors that influenced the engineering and design of the Project are as follows:

1. Shut-in Analysis: As discussed above, the Project Team completed an RER analysis and concluded Supply Line 44-720 could not be taken out of service. The pipeline is a primary feed to two major supply line systems (Supply Line 38-556 and Supply Line 38-552) and Pressure Districts with high demand. As a result, the Project Team installed pressure control fittings (PCFs) with bypass capabilities to the design to maintain gas service during tie-in operations.
2. Installation Method: The Project Team utilized horizontal directional drilling (HDD) to route through Caltrans and Union Pacific Railroad (UPRR) right of ways (ROW). For construction outside Caltrans and UPRR ROW, the Project Team utilized open trench installation.
3. Diameter Changes: For piggability, the Project Team utilized [REDACTED] diameter pipe to achieve uniform diameter with the connected pipeline Supply Line 38-539 and to take advantage of the more cost-effective pipeline that SoCalGas and SDG&E had purchased at a bulk discount.
4. Customer Impact: Through the use of PCFs with bypass capabilities, the Project Team prevented any customer outages, and temporary service was not required.

Pipeline Safety Enhancement Plan Final Report
Supply Line 44-720 Replacement Project

5. Known Substructures: Prior to construction, multiple utilities were identified and included in the Project design.
6. Valves: The Project Team identified existing reduced port valves for replacement with full port ball valves to enable pigability.
7. Taps: The Project Team identified three service taps and two lateral connection replacements.
8. Other Identified Risks: The Project Team identified that the existing pipeline had known failures and repairs of the spiral weld longseam. As a result, the Project Team included replacement of the Accelerated pipe by designing the east tie-in location to connect the new replacement pipe to the adjacent Supply Line 38-556, thereby eliminating all the spiral welded pipe of Supply Line 44-720 and eliminating a future separate short section replacement project in Phase 2A.

D. Scope Changes

Through engineering, design, and planning activities, SoCalGas and SDG&E determined that changes in scope were appropriate to enhance the design of the Project and address engineering factors. Summarized below are notable changes:

1. SoCalGas and SDG&E's preliminary estimate assumed use of three PCFs to accommodate tie-ins. The new west tie-in design configuration provided a cost avoidance since it only utilized one PCF, whereas the original design utilized three PCFs.

Pipeline Safety Enhancement Plan Final Report
Supply Line 44-720 Replacement Project

Prior to construction, the Project Team identified one of the taps scoped for tie-in with the replacement was already scheduled for abandonment as part of an upcoming non-PSEP project. The Project Team removed this tap tie-in from the replacement scope as a result.

Pipeline Safety Enhancement Plan Final Report Supply Line 44-720 Replacement Project

III. CONSTRUCTION

A. Construction Contractor Selection

The Project Team prepared an initial cost estimate based on the preliminary design. Following completion of the engineering, design, and planning activities described above, the Project Team directed the Performance Partner to prepare cost estimates based on a more detailed engineering design package, which included the updated design described in the discussion of notable Scope Changes above. SoCalGas and SDG&E awarded the construction contract to the Performance Partner.

1. SoCalGas and SDG&E's Preliminary Construction Cost Estimate (*confidential*):

SoCalGas and SDG&E's preliminary cost estimate for construction was [REDACTED].

2. Construction Contractor's Target Price Estimate (*confidential*): The Construction

Contractor's construction cost estimate was [REDACTED], which was [REDACTED] than SoCalGas and SDG&E's preliminary cost estimate for construction.

B. Construction Schedule

Table 3: Construction Timeline

Construction Start Date	06/22/2015
Construction Completion Date	10/09/2015
NOP Date	09/22/2015

Pipeline Safety Enhancement Plan Final Report
Supply Line 44-720 Replacement Project

C. Changes During Construction

The conditions summarized below were encountered during construction. Activities to address or mitigate these conditions resulted in approximately \$760,000 in change orders.

1. Tie-in:

- a. Once excavated, the condition of the existing pipeline at the original west tie-in location was not suitable to provide a quality tie-in weld due to existing spiral welded pipe. The Project Team investigated an alternative tie-in location on the north side of Olive Street. Construction activities included investigative potholing and hand digging to not disturb the existing pipeline coating. Based on the findings, the alternative tie-in location was also not feasible for the same reason.
- b. The Project Team located a second alternative location for the west tie-in on downstream adjacent pipeline Supply Line 38-539, approximately 1,200 feet west from the original tie-in location on Olive Street (Avenue 152). The Project Team extended the length of the replacement to relocate the west tie-in beyond a spiral welded pipe segment that was previously repaired and because upon exposing the originally planned tie-in location the pipe was found to be in poor condition. Similarly, tie-in locations on the section of Supply Line 38-539 that was north (see figure 2) was also moved to a new location to eliminate spiral welded pipe in poor condition. The replacement of the spiral welded pipe segment increased the integrity of Supply Line 38-539. SoCalGas and SDG&E initially recognized the additional replacement of the spiral welded pipe on Supply Line 38-539 as an Accelerated Phase 2A project. Due to changes in the Class location for this area that occurred after the 2011 Filling, a section of Supply Line 38-539 changed to a Class 3 location.

Pipeline Safety Enhancement Plan Final Report
Supply Line 44-720 Replacement Project

The Class location change resulted in an additional 126 feet of the Accelerated Phase 2A pipe becoming Category 4 Criteria pipe. Changes in construction activities required for this additional installation and alignment included:

- i. To safely shore and maintain the integrity of the road, the Construction Contractor backfilled the trenched alignment and excavated a new alignment through the same area.
 - ii. Approximately 1,200 feet of additional open-cut trench installation, of that approximately 100 feet was excavated 16-inches deeper leading up to the HDD tie-in to achieve required separation from existing utilities.
 - iii. Fabrication of a new tie-in spool and installation of small diameter fittings for gas handling and seasoning.
2. Gas Handling: The Project Team experienced complications during isolation for tie-ins. A PCF did not seal effectively. The Project Team installed an additional PCF through hot tapping to achieve effective isolation. In the interim of setting the PCFs, passed gas required additional aeration and ongoing gas monitoring. Difficulties with the completion plug removals and tapping machine malfunctions caused additional delays.
 3. Laydown Yard: In accordance with Storm Water Pollution Prevention Plan (SWPPP) closeout, the Construction Contractor hydroseeded 2.25 acres of the laydown yard as a post construction erosion control measure.
 4. Substructures: During construction, the Project Team identified additional unmarked utilities, that resulted in field changes of the alignment, including installing the pipeline two feet deeper for approximately 100 feet and increasing the installed depth of a new mainline valve and bridle connection.

Pipeline Safety Enhancement Plan Final Report Supply Line 44-720 Replacement Project

5. Work Hours: The Construction Contractor scheduled line seasoning to occur on 08/20/2015; however, the SoCalGas and SDG&E seasoning crew was only available on 08/18/2015. To accommodate the schedule, SoCalGas and SDG&E scheduled the contractor work on a Saturday to complete the required work to prepare the line for seasoning.
6. Traffic: Caltrans required a shoulder closure for survey to monitor grade during HDD construction.

Pipeline Safety Enhancement Plan Final Report Supply Line 44-720 Replacement Project

Figure 3: HDD Pullback String Installation



Pipeline Safety Enhancement Plan Final Report Supply Line 44-720 Replacement Project

D. Commissioning and Site Restoration

Commissioning activities include restoration of the site, final inspection and placement of the pipeline back into service, transportation and disposal of hydrotested water and hazardous material, and site demobilization. Closeout activities include development of final drawings, finalization of a reconciliation package, and updates to company recordkeeping systems to reflect the completed scope of work.

IV. PROJECT COSTS

A. Cost Avoidance Actions

SoCalGas and SDG&E exercised due diligence in the planning, design, and construction activities for this project to minimize or avoid costs when prudent to do so. As discussed above, the Project Team conducted a site visit to identify and incorporate discernable site conditions into the engineering, design, and planning of the Project. Specific examples of cost avoidance actions taken on this project are:

1. Engineering and Design:
 - a. During Project planning, the Project Team identified one of the taps scoped for tie-in with the replacement that was scheduled for abandonment as part of an upcoming non-PSEP project. They removed this tap tie-in from the replacement scope.
 - b. The Project Team redesigned the new west tie-in configuration utilizing one PCF, whereas the original design utilized three PCFs.
2. Materials: Bulk ordered pipe provided volume pricing for the [REDACTED] pipe.
3. Permit Conditions: The Tulare County encroachment permit initially required backfilling of all open trench daily and restricted open trench to 1,000 feet. Following the start of construction, SoCalGas and SDG&E successfully negotiated more efficient construction conditions. Tulare County allowed traffic plating of open trenches instead of backfilling each night and increased the maximum allowable open trench to 1,500 feet. This favorable outcome greatly reduced the required excavation, increasing productivity, and saved costs that would have resulted from re-excavating the trench daily.

Pipeline Safety Enhancement Plan Final Report
Supply Line 44-720 Replacement Project

4. Construction Execution:

- a. Due to the known condition of the pipe, SoCalGas and SDG&E opted to have the Construction Contractor excavate the tie-in locations at the beginning of the Project. As a result, SoCalGas and SDG&E found that the planned west tie-in was not suitable and relocated it. The Project Team investigated alternative tie-in options and completed the redesign without impacting the construction schedule.
- b. Shoring for a new [REDACTED] tap installation was not feasible due to the position of an existing [REDACTED] line identified during construction. As a result, the Construction Contractor moved the [REDACTED] tee connection to a different installation location. This location required less excavation than the original design location due to shallower depth of the existing pipe. This field change produced a cost savings.

B. Cost Estimate

Based on the preliminary design, once the project scope was confirmed and engineering, design, and planning activities were underway, SoCalGas and SDG&E prepared an estimate of the Direct Costs of the Project in the amount of \$10,438,832. This estimate was prepared in February of 2015, using the “SCG Pipeline Estimate Template Rev 0” estimating tool, the most current version of the PSEP Estimate Template at the time. The Project Team considered the conditions known at the time to prepare the preliminary Direct Cost estimate. This estimate reflects the projected Labor, Material and Services costs anticipated to be incurred to execute the Project.

SoCalGas and SDG&E estimated Indirect Costs of the Project based on the estimated Direct Costs and other project-related variables.

Pipeline Safety Enhancement Plan Final Report
Supply Line 44-720 Replacement Project

C. Actual Direct and Indirect Costs

Actual Direct Costs reflect the Labor, Material, and Service costs incurred to execute the Project. Actual Indirect Costs reflect costs for incremental overhead loaders in accordance with Company overhead allocation policies. The total loaded cost of the Project is \$10,990,155.

Table 4: Estimated and Actual Direct Costs and Variances

Direct Costs (\$)	Estimate	Actuals	Delta Over/(Under)
Company Labor	440,712	307,840	(132,872)
Materials	631,443	448,539	(182,904)
Construction Contractor	5,597,392	4,508,305	(1,089,087)
Construction Management & Support	728,158	1,012,937	284,779
Environmental	481,104	302,501	(178,603)
Engineering & Design	942,205	1,746,258	804,053
Project Management & Services	334,996	302,907	(32,089)
ROW & Permits	179,531	155,860	(23,671)
GMA	1,103,291	1,143,616	40,325
Total Direct Costs	10,438,832	9,928,763	(510,069)

Table 5: Estimated and Actual Indirect Costs, Total Costs, and Variances

Indirect Cost/Total Costs (\$)	Estimate	Actuals	Delta Over/(Under)
Overheads	985,178	856,473	(128,705)
AFUDC	265,941	182,381	(83,560)
Property Taxes	53,083	22,538	(30,545)
Total Indirect Costs	1,304,202	1,061,392	(242,810)
Direct Costs	10,438,832	9,928,763	(510,069)
Total Loaded Costs	11,743,034	10,990,155	(752,879)

Pipeline Safety Enhancement Plan Final Report Supply Line 44-720 Replacement Project

D. Disallowances

There was no disallowance for Supply Line 44-720 Replacement Project as there were no post-1955 segments included in the Project without records that provide the minimum information to demonstrate compliance with then applicable industry standards or regulatory strength testing and recordkeeping requirements then applicable.

Pipeline Safety Enhancement Plan Final Report
Supply Line 44-720 Replacement Project

V. CONCLUSION

SoCalGas and SDG&E enhanced the safety of their integrated natural gas transmission system by prudently executing the Supply Line 44-720 Replacement Project. Through this Replacement Project, SoCalGas and SDG&E successfully replaced 1.493 miles of pipe in the City of Tipton. The total loaded cost of the Project is \$10,990,155.

SoCalGas and SDG&E executed this project prudently by using construction methods of HDD, open trench, and routing the alignment for tie-ins around existing utilities, and enhancing piggability through the replacement of non-piggable pipe with a known history of long seam failure along a segment of spiral welded pipe. Also, SoCalGas and SDG&E effectively addressed other unknown conditions as they occurred in the field (such as a PCF that would not seal, and unmarked underground utilities that required realignment) to accomplish the Commission's directive to complete work as soon as practicable.

SoCalGas and SDG&E engaged in prudent cost avoidance efforts through bulk ordering materials and making reasonable efforts to promote competitive and market-based rates for contractor services and materials, using market-based rates based on a recent competitive sourcing, reasonably utilized company and contractor resources given the complex scope of work and scope changes (e.g. engineering redesigns driven by substructures).

End of Supply Line 44-720 Replacement Project Final Report
