

Volume II

PIPELINE SAFETY AND ENHANCEMENT PLAN (PSEP)
2018 REASONABLENESS REVIEW – A.18-11-010
AMENDED WORKPAPERS
TABLE OF CONTENTS

Workpaper Page No.	Workpaper Chapter Title
WP-Intro-1 - 16	Introduction to Workpapers Supporting the Testimony of Rick Phillips: Chapter II, Chapter III, and Hugo Mejia: Chapter IV
WP-SCS-1 - 19	Appendix A - Standard Construction Summary for Replacement, Hydrotest and PSEP Valve Projects
WP-G-1 - 13	Appendix B - Glossary
WP-III-A1 - A1037	Pipeline Pressure Test/Replacement Projects
WP-IV-A1 - A914	Valve Enhancement Projects
WP-VII-A1 - A6	Company Overheads
WP-IX-A1 - A8	Revenue Requirements

Pipeline Safety Enhancement Plan Final Report
Supply Line 49-15 Replacement Project

I. SUPPLY LINE 49-15 REPLACEMENT PROJECT

A. Background and Summary

Supply Line 49-15 is a [REDACTED] diameter transmission line that runs approximately 7.4 miles from the City of El Cajon to the City of La Mesa. The pipeline is primarily routed across a Class 3 location. This report describes the activities associated with the Supply Line 49-15 Replacement Project, which consists of the replacement and reroute of 1.013 miles (Section 1)¹, the replacement of 1.777 miles for Section 2 and Section 3, and the addition of a new regulator station. The specific attributes of this Project are detailed in Table 1 below. The total loaded cost of the Project is \$43,488,794.

Table 1: General Project Information

Project Name	Section 1
Project Type	Replacement
Length	1.013 miles
Location	City of La Mesa
Class	3
MAOP (<i>confidential</i>)	[REDACTED]
Pipe Vintage	1950
Construction Start	11/09/2015
Construction Finish	10/25/2016
Original Pipe Diameter (<i>confidential</i>)	[REDACTED]
New Diameter (<i>confidential</i>)	[REDACTED]
Original SMYS (<i>confidential</i>)	[REDACTED]
New SMYS (<i>confidential</i>) ²	[REDACTED]

¹ The rerouted portion of Section 1 interconnects with Line 3600 and has been renamed Line 1033. Abandonment of replaced pipeline segment is scheduled for late November 2018.

² Highest percentage of Specified Minimum Yield Strength (SMYS) of Category 4 Criteria pipe.

Pipeline Safety Enhancement Plan Final Report
Supply Line 49-15 Replacement Project

Table 1: General Project Information (Continued)

Project Name	Section 2 and Section 3		
Project Type	Replacement		
Length	1.777 miles		
Location	City of La Mesa, City of El Cajon		
Class	3		
MAOP (<i>confidential</i>)	[REDACTED]		
Predominant Pipe Vintage	1950		
Construction Start	02/01/2016		
Construction Finish	07/31/2017		
Original Pipe Diameter (<i>confidential</i>)	[REDACTED]		
New Diameter (<i>confidential</i>)	[REDACTED]		
Original SMYS (<i>confidential</i>)	[REDACTED]		
New SMYS (<i>confidential</i>)	[REDACTED]		
Project Costs (\$)	Capital	O&M	Total
Loaded Project Costs	43,488,767	27	43,488,794
Disallowed Costs	-	-	-

Pipeline Safety Enhancement Plan Final Report
Supply Line 49-15 Replacement Project

B. Maps and Images

Figure 1: Satellite Image of Supply Line 49-15 Replacement Project

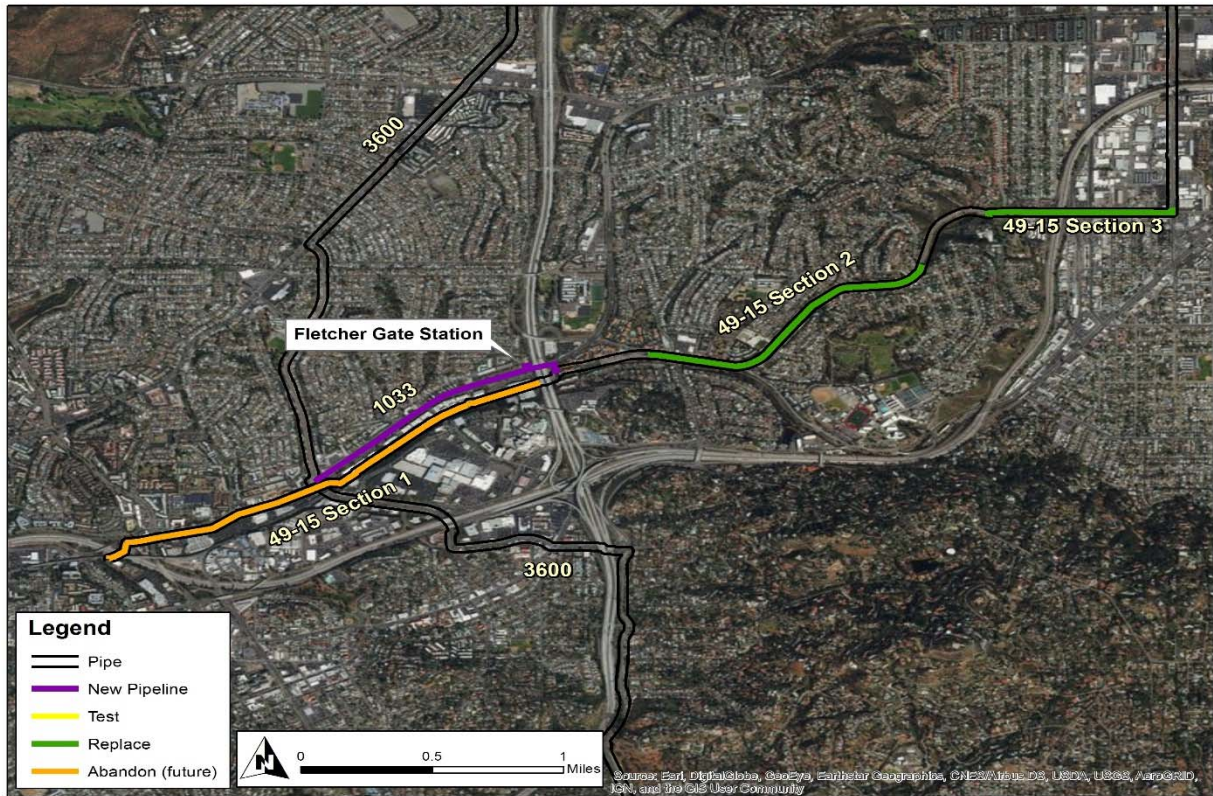

Pipeline Safety Enhancement Plan Final Report Supply Line 49-15 Replacement Project

Figure 2: Overview Map of Supply Line 49-15 Replacement Project



Pipeline Safety Enhancement Plan Final Report
Supply Line 49-15 Replacement Project

Figure 3: Satellite Image of Supply Line 49-15 Section 1 Replacement Project



Pipeline Safety Enhancement Plan Final Report
Supply Line 49-15 Replacement Project

Figure 4: Overview Map of Supply Line 49-15 Section 1 Replacement Project



Pipeline Safety Enhancement Plan Final Report
Supply Line 49-15 Replacement Project

Figure 5: Satellite Image of Supply Line 49-15 Section 2 Replacement Project



Pipeline Safety Enhancement Plan Final Report
Supply Line 49-15 Replacement Project

Figure 7: Satellite Image of Supply Line 49-15 Section 3 Replacement Project

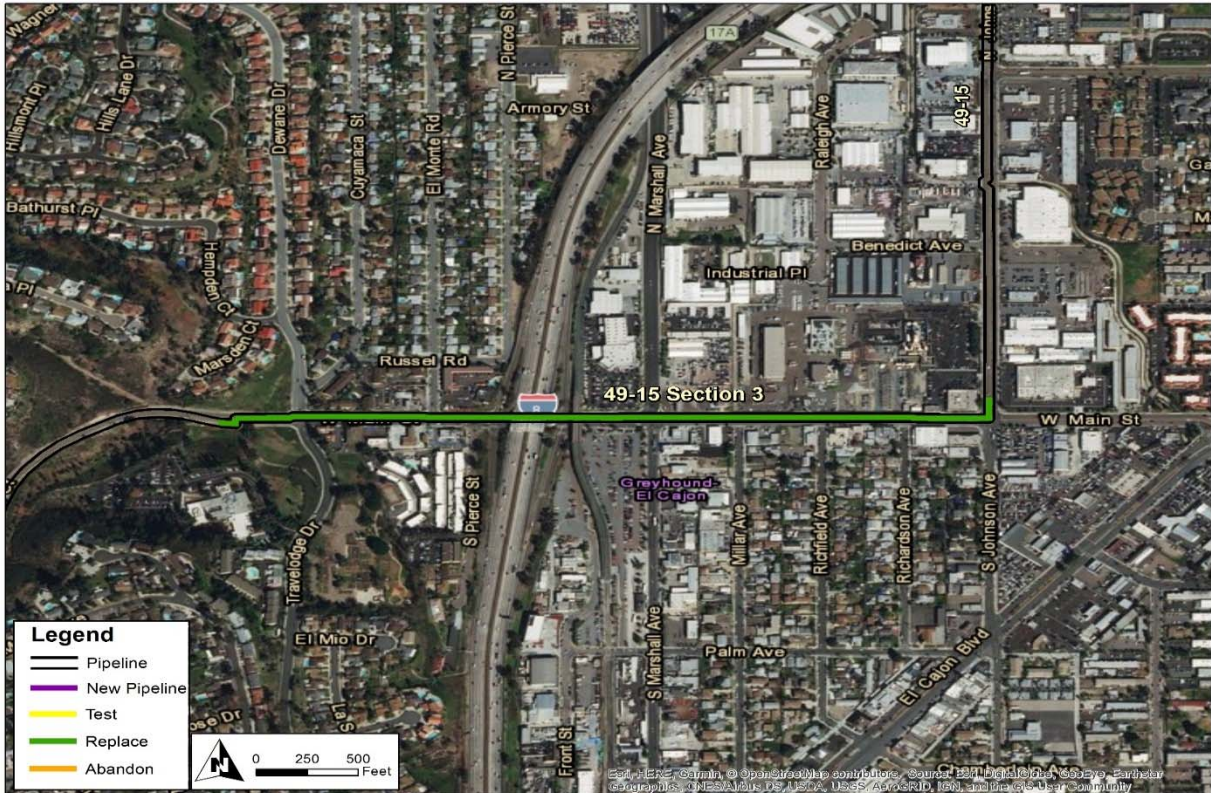

Pipeline Safety Enhancement Plan Final Report
Supply Line 49-15 Replacement Project

Figure 8: Overview Map of Supply Line 49-15 Section 3 Replacement Project



Pipeline Safety Enhancement Plan Final Report
 Supply Line 49-15 Replacement Project

Figure 9: Supply Line 49-15 Sections 1, 2, and 3 Replacement Project Schematic

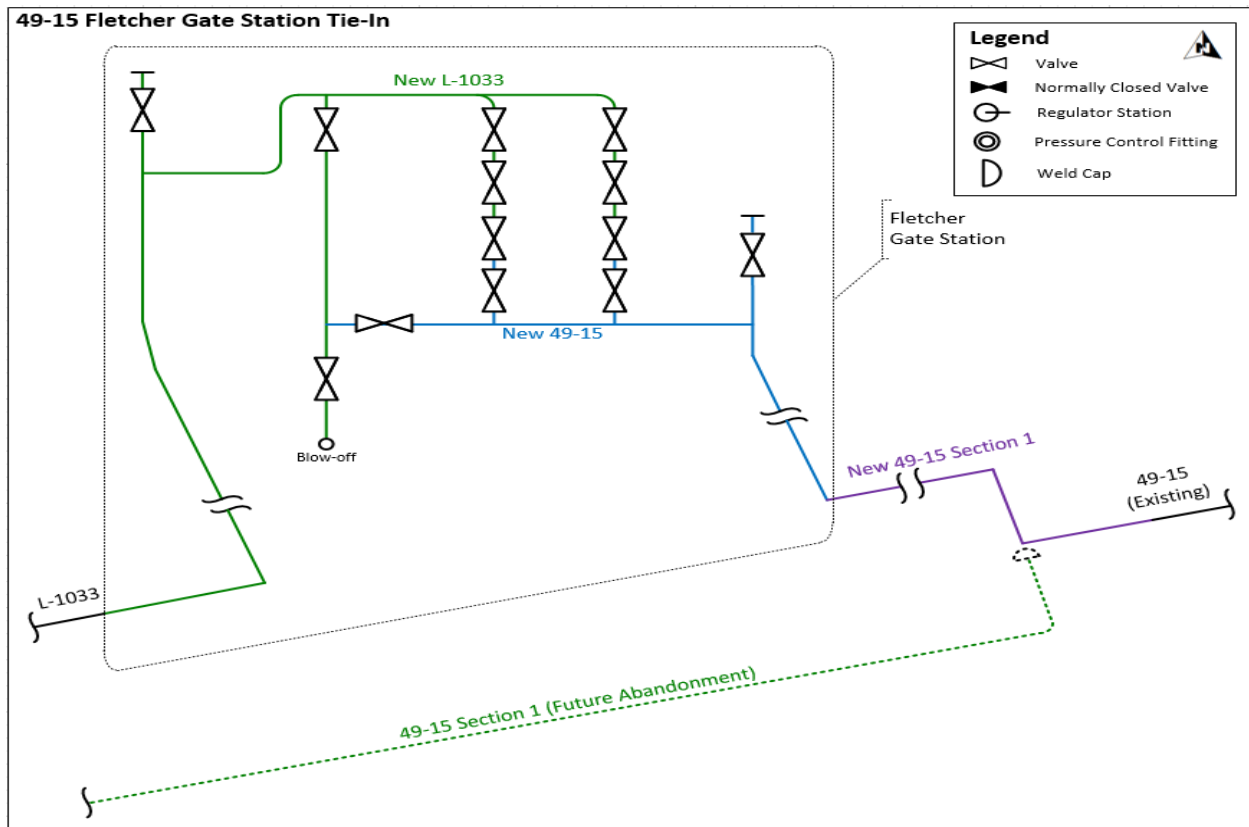

Pipeline Safety Enhancement Plan Final Report
Supply Line 49-15 Replacement Project

II. ENGINEERING, DESIGN, AND PLANNING

A. Project Scope

Table 2: Mileage Information

	Criteria	Accelerated ³	Incidental	New ⁴	Total ⁵
Final Mileage	1.581 mi.	0.051 mi.	0.117 mi.	1.041 mi.	2.790 mi.
	8,350 ft.	271 ft.	615 ft.	5,495 ft.	14,732 ft.

SoCalGas and SDG&E presented a conceptual project scope in workpapers supporting the 2011 PSEP filing.⁶ Prior to initiating execution of the Project in 2015, SoCalGas and SDG&E reviewed existing pipeline records to validate the scope of the Project. During the Engineering, Design, and Planning phase, SoCalGas and SDG&E further refined the scope. The progression of project scope is summarized as follows:

1. **2011 PSEP Filing:** SoCalGas and SDG&E identified Supply Line 49-15 as a Phase 1A Replacement and Hydrotest Project comprised of 1.978 miles of Category 4 Criteria pipe and 4.626 miles of Accelerated pipe.
2. **Scope Validation:** Through scope validation activities, after the 2011 filing and before initiating execution of the Project, SoCalGas and SDG&E increased the scope of the Project by 1.064 miles of Category 4 Criteria pipe and reduced the Accelerated mileage by 4.575 to correct an inadvertent calculation error in the initial 2011 Filing.

³ Accelerated mileage includes Phase 2B pipe. Phase 2B includes pipelines with record of a pressure test, but without record of a pressure test to modern – Subpart J – standards (Phase 2B). The Accelerated mileage was included to realize efficiencies and to enhance project constructability.

⁴ Total mileage of the completed project differs from the mileage of the pipe addressed due to realignment of the pipeline route.

⁵ Values may not add to total due to rounding.

⁶ See Amended PSEP of SoCalGas and SDG&E, submitted December 2, 2011, in R.11-02-019 and subsequently transferred to A.11-11-002.

Pipeline Safety Enhancement Plan Final Report
Supply Line 49-15 Replacement Project

3. Engineering, Design, and Constructability:

- a. In order to maintain service to core customers and for constructability purposes, the Project Team split the Project into three non-contiguous project sections for execution and project management purposes.
- b. The Project Team determined the most prudent option to execute Section 1 was to reroute a portion of Section 1⁷ to interconnect with Line 3600, abandon the Category 4 Criteria pipe, and install a new regulator station (Fletcher Gate Station). The new route is about 0.8 miles shorter than the original route and will be operated at a higher pressure, the same pressure as Line 3600. Section 1 is pending future abandonment as part of the Line 49-16 Replacement Project. Complete abandonment of both projects is scheduled for late November 2018. Factors that led SoCalGas and SDG&E to determine hydrotesting was not the more prudent option include: (1) the anticipated cost to retrofit 12 non-piggable fittings to enable hydrotesting; (2) the cost of acquiring long lead permits; (3) the cost to acquire temporary rights-of-entry (TREs); (4) the risk of testing under private properties; (5) the risk of testing under a freeway when the pipe attributes were unknown; and (6) anticipated customer impacts.
- c. Section 2 and Section 3 are separated by a large segment of non-Criteria pipe, and SoCalGas and SDG&E's ability to isolate the sections are restricted by the need to maintain service to customers in each section. The Project Team decided to replace the Category 4 Criteria pipe in Section 2 and Section 3. The Project Team determined that replacement was more prudent based on the comparable costs of retrofitting 19 non-piggable fittings in Section 2 and 17 non-piggable fittings in Section 3 to enable hydrotesting.

⁷ The rerouted pipeline segment has been renamed Line 1033.

Pipeline Safety Enhancement Plan Final Report
Supply Line 49-15 Replacement Project

4. Final Project Scope: The final project scope consists of the reroute of 1.013 miles of pipe and the replacement of 1.581 miles of Category 4 Criteria pipe. The Project consists of 0.051 miles of Accelerated Phase 2B pipe and 0.117 miles of Incidental pipe to facilitate tie-ins to existing portions of pipeline and regulator stations.

B. Decision Tree Analysis

SoCalGas and SDG&E performed a PSEP Decision Tree analysis of Supply Line 49-15 and confirmed the Project design should commence as a Replacement project.

For pipeline segments longer than 1,000 feet in length, under the approved PSEP Decision Tree, SoCalGas and SDG&E complete a preliminary review to determine whether SoCalGas and SDG&E can manage customer service impacts if the pipeline segment is taken out of service for a period of two to six weeks to complete pressure testing. Where mitigation of customer impacts to remove the line from service for pressure testing is feasible, SoCalGas and SDG&E compare the costs, constructability, risks and benefits of pressure testing and replacement to determine whether pressure testing or replacement is the more prudent option.

Through this Decision Tree analysis, SoCalGas and SDG&E identified replacement as the more prudent option. Key considerations that support SoCalGas and SDG&E's determination to replace this segment include:

1. Shut-In Analysis: The Project Team completed a Request for Engineering Review (RER) analysis and identified feeds to ten regulator stations and one to a major hospital. The RER concluded the entirety of Supply Line 49-15 could not be shut-in, however, the line could be isolated in sections during low demand periods to maintain customer service.

Pipeline Safety Enhancement Plan Final Report
Supply Line 49-15 Replacement Project

2. Customer Service: The Project Team would need to install bypasses, or use compressed natural gas (CNG) or liquefied natural gas (LNG) in order to maintain customer service with minimal interruption during the long-term sectional shut-ins required to enable pressure testing.
3. Permit Conditions: At the time the Project Team conducted the Decision Tree Analysis, the plan was to bore underneath the Interstate 8 freeway, which would have required a Caltrans permit for Section 1.
4. Piggability: Non-piggable.
5. Pipe Vintage: 1950.
6. Existing Pipe Attributes: The Project Team identified multiple unpiggable features that required replacement to make the pipeline piggable for hydrotesting and dewatering. 48 features were identified within the three Project sections.
7. Longseam Type: Unknown.
8. Condition of Coating: Coating was loose at certain locations.
9. Other Identified Risks: The Project Team identified instances of previous third party damage that occurred in 1985.

C. Engineering, Design, and Planning Factors

SoCalGas and SDG&E reviewed pipeline drawings and other information, contacted internal planning groups, communicated with external stakeholders, conducted survey activities, including reviewing public records and potholing of the area to confirm the presence of underground utilities and substructures, and completed a pre-design site walk. Key factors that influenced the engineering and design of the Project are as follows:

Pipeline Safety Enhancement Plan Final Report
Supply Line 49-15 Replacement Project

Section 1

1. Shut-In Analysis: As discussed above, the Project Team planned the required shut-ins in three Project sections, as recommended by the RER analysis to maintain customer service. Section 1 serves approximately 16,000 core customers via six regulator stations, and one hospital cogeneration non-core customer via a [REDACTED] lateral. The hospital customer, and one regulator station, servicing local medical offices, did not have alternative feeds should the line be shut-in. Therefore, the Project Team determined a shut-in of this section to be infeasible.
2. Customer Impacts: The Project Team planned to maintain service to a hospital cogeneration and a regulator station by using pressure control fittings (PCFs) and planning tie-in activities to correspond with system demands.
3. Schedule Coordination: The Project Team scheduled construction activities concurrently with other PSEP projects in the area.⁸ This allowed for the strategic sharing of laydown and storage yards within proximity of the Project.
4. Land Use: Acquisition of land and building permits from the City of La Mesa required prior to constructing the Fletcher Gate Regulator Station lasted 18 months longer than anticipated due to negotiations with the City for the property and final permit approval for all site improvements. These delays impacted the construction schedule.
5. Environmental: The Project Team identified multiple environmental factors that affected planning. The Project Team secured a Storm Water Pollution Prevention Plan (SWPPP), Sewer Discharge Permit, Reclaimed Water Permit, and an Engineering Report.

⁸ The concurrent projects include the Line 49-1 Replacement, Line 49-13 Replacement and Hydrotest, and Line 49-17 Replacement Projects.

Pipeline Safety Enhancement Plan Final Report
Supply Line 49-15 Replacement Project

6. Reroute:
 - a. Section 1 rerouted the new line by connecting to Line 3600 and aligning the pipeline along a road within public right-of-way (ROW).
 - b. By rerouting the pipeline and adding a new regulator station along the public ROW, the Project Team avoided the cost to bore under a major freeway, the cost for permitting a bore through Caltrans ROW, and the anticipated impacts to multiple private properties.
 - c. The reroute alignment is approximately 0.85 miles shorter than the original pipeline alignment.
7. Valves: Section 1 included the installation of one new [REDACTED] valve, three [REDACTED] valves, two [REDACTED] check valves, and one [REDACTED] valve.
8. Tie-In: The Project Team scheduled tie-in construction activities during low demand periods, and coordinated with the hospital for their cogeneration feed.

Section 2

1. Shut-In Analysis: The Project Team planned the shut-ins in three sections as recommended by the RER analysis to maintain customer service. Section 2 provides service to approximately 5,600 core customers and can be shut-in without impacting service during periods with low customer demand.
2. Customer Impacts: Customer service was maintained by planning tie-in activities to correspond with system demands.

Pipeline Safety Enhancement Plan Final Report
Supply Line 49-15 Replacement Project

3. Schedule Coordination: The Project Team scheduled construction activities concurrently with other PSEP projects in the area.⁹ This allowed for the strategic sharing of laydown and storage yards within proximity to the Project.
4. Permit Conditions: The Project Team acquired encroachment permits from the City of La Mesa to work on city streets.
5. Environmental: The Project Team identified multiple environmental factors that affected planning. The Project Team secured a Stormwater Pollution Prevention Plan (SWPPP) permit, Sewer Discharge Permit, Reclaimed Water Permit, and an Engineering Report.
6. Valves: Section 2 included the replacement of one [REDACTED] valve.
7. Tie-In: The Project Team scheduled tie-in activities during low demand periods.

Section 3

1. Shut-In Analysis: The Project Team planned the shut-ins in three sections as recommended by the RER analysis to maintain reliable service to customers. Section 3 serves approximately 10,000 core customers and could be shut-in without impacting service.
2. Customer Impacts: The Project Team maintained customer service by planning tie-in activities to correspond with system demands.
3. Schedule Coordination: The Project Team scheduled construction activities concurrently with other PSEP projects in the areas.¹⁰ This allowed for the strategic sharing of laydown and storage yards within proximity to the Project.

⁹ Concurrent projects include the Line 49-25 Replacement, 49-26 Replacement, Line 49-13 Replacement and Hydrotest, and Line 49-17 Replacement Projects.

¹⁰ Concurrent projects include Line 49-1 Replacement Project, Line 49-13 Replacement and Hydrotest, and Line 49-17 Replacement.

Pipeline Safety Enhancement Plan Final Report
Supply Line 49-15 Replacement Project

4. Permit Conditions: The Project Team acquired encroachment permits from the City of El Cajon for work on city streets.
5. Environmental: The Project Team identified multiple environmental factors that affected planning. The Project Team secured a SWPPP permit, Sewer Discharge Permit, Reclaimed Water Permit, and an Engineering Report.
6. Valves: Section 3 included the replacement of one [REDACTED] valve.
7. Tie-In: The Project Team scheduled tie-in activities during low demand periods.

D. Scope Changes

SoCalGas and SDG&E did not make any notable scope changes during detailed design.

Pipeline Safety Enhancement Plan Final Report
Supply Line 49-15 Replacement Project

III. CONSTRUCTION

A. Construction Contractor Selection

The Project Team prepared an initial cost estimate based on the preliminary design. Following completion of the engineering, design, and planning activities described above, the Project Team directed the Performance Partner to prepare cost estimates based on a more detailed engineering design package. As indicated above, there were no notable changes in scope between the time when the Project Team prepared the preliminary cost estimate and when the Performance Partner prepared and submitted its Target Price Estimate. SoCalGas and SDG&E awarded the construction contract to the Performance Partner.

1. SoCalGas and SDG&E's Preliminary Construction Cost Estimate (*confidential*):
SoCalGas and SDG&E's preliminary estimate for construction was [REDACTED].
2. Construction Contractor's Target Price Estimate (*confidential*): The Construction Contractor cost estimate was [REDACTED], which was [REDACTED] than SoCalGas and SDG&E's preliminary cost estimate for construction.

Pipeline Safety Enhancement Plan Final Report
Supply Line 49-15 Replacement Project

B. Construction Schedule

Table 3: Construction Timeline

Section 1	
Construction Start Date	11/09/2015
Construction Completion Date	10/25/2016
NOP Date	12/31/2015
Section 2	
Construction Start Date	02/01/2016
Construction Completion Date	08/12/2016
NOP Date	05/18/2016
Section 3	
Construction Start Date	10/04/2016
Construction Completion Date	07/31/2017
NOP Date	12/20/2016

C. Changes During Construction

The conditions summarized below were encountered during construction. Activities to address or mitigate these conditions resulted in approximately \$2,300,000 in change orders.

1. Permits Conditions:

- a. The City of La Mesa directed the Project Team to grind and cap from curb and gutter to the center line of road. This added an approximately 88,000 square feet of pavement to street restoration.
- b. The City of La Mesa directed the Project Team to place recessed plates over trenches. This condition was unanticipated and not identified on the original permit. In order to fulfill the request, the Construction Contractor devoted additional efforts to grind asphalt along trench edges including labor, subcontractors, and waste fees.

Pipeline Safety Enhancement Plan Final Report
Supply Line 49-15 Replacement Project

- c. The City of La Mesa and the City of El Cajon requested T-cuts on asphalt prior to any pavement restorations. T-cuts were not planned and were not in the Construction Contractor's estimate. This work led to additional saw cutting, disposal, and paving.
 - d. The City of La Mesa requested additional landscape restoration that was not in the Construction Contractor's estimate to the Fletcher Parkway and Jackson Drive tie-in site.
 - e. The City of La Mesa required the Project Team to perform additional landscape work not in the original scope at the Fletcher Gate Station and remove several trees to accommodate a change of location for a drainage ditch.
 - f. The City of La Mesa requested night work, which required renting light towers, and additional premium costs, such as plant and dump opening fees, traffic control, and labor.
2. Substructures:
- a. An unknown fiber optic line was encountered within the planned alignment for the new [REDACTED] pipeline requiring a change in the alignment. In order to shift alignment, the line had to cross under a 68-inch water line, which resulted in the installation of a drop section that required additional material and excavation efforts. The new alignment also shifted into the second lane of the road and required additional traffic control.
 - b. A communication line was incorrectly marked near a proposed vault location. The Construction Contractor utilized vacuum trucks to locate and expose any substructures that could interfere at the alternate site for vault installation.
3. Traffic: The Project Team requested additional flaggers to enhance the safety of temporary traffic control implementations during construction.

Pipeline Safety Enhancement Plan Final Report
Supply Line 49-15 Replacement Project

4. Access: The Project started construction once all materials and permits necessary to begin were procured, however, land acquisition at Fletcher Gate Station was not finalized as anticipated by the time construction had progressed to the station. The Project Team installed temporary piping until the land acquisition was finalized. This required the Construction Contractor to demobilize and return approximately 18 months later.
5. Field Design Change:
 - a. The Construction Contractor installed an asphalt driveway at the Fletcher Gate Station site instead of the planned gravel driveway.
 - b. The Construction Contractor relocated the planned head wall at the Fletcher Gate Station to avoid constructing a retaining wall that would have been required by the City of La Mesa. The relocation of the head wall required additional efforts to realign the already installed brow ditch to connect to the head wall.
 - c. The Construction Contractor extended and widened the east test head location for Section 1.
 - d. The Project Team determined electrolysis test stations (ETSS) could not be installed in the original planned location and relocated the ETSS to the side of the road.
6. Work Hours: Permitted work hours were significantly less than planned. Hours changed from 7:00 am to 4:30 pm, to 8:30 am to 4:30 pm in the City of La Mesa, and 8:30 am to 3:30 pm in the City of El Cajon. To offset these work hours, the Construction Contractor worked weekends.
7. Soil Conditions: The Construction Contractor utilized specialized rock breaking equipment and additional crews to break rock and granite encountered at multiple sites. Additional disposal premiums are associated with these activities.

Pipeline Safety Enhancement Plan Final Report
Supply Line 49-15 Replacement Project

8. Schedule Delay: The unplanned delay in acquiring the Fletcher Gate Station property resulted in additional field support costs to support the completion of this project.
9. Weather: There were significant impacts curing construction due to rain. This resulted in efforts to dewater and repair excavation sites, clean-up, and restore many unpaved locations by the Construction Contractor.
10. Gas Handling: Issues with the Fletcher Gate Station delayed the tie-in activities in Section 1. The tie-in location required steel plates for a duration longer than anticipated to cover the excavated site. The pipe depth was also identified to be deeper than planned and required additional excavation.
11. Materials: Materials arrived damaged and were repaired on site.
12. Utility Coordination: The Project encountered a delay due to the presence of a sewer contractor in the vicinity of a tie-in location near Alvarado Road. The city would not allow two contractors to work in the same vicinity.

Pipeline Safety Enhancement Plan Final Report
Supply Line 49-15 Replacement Project

Figure 10: Pumping Water from Bellhole



Pipeline Safety Enhancement Plan Final Report
Supply Line 49-15 Replacement Project

Figure 11: Hydrotest Contractor Setting Fill Pipe



Pipeline Safety Enhancement Plan Final Report Supply Line 49-15 Replacement Project

Figure 12: Breaking Rock (Granite)



Pipeline Safety Enhancement Plan Final Report
Supply Line 49-15 Replacement Project

Figure 13: Traffic Control in Place



Pipeline Safety Enhancement Plan Final Report
Supply Line 49-15 Replacement Project

D. Commissioning and Site Restoration

Commissioning activities include restoration of the site, final inspection, and placement of the pipeline back into service, transportation and disposal of hydrotested water and hazardous material, and site demobilization.

Closeout activities include development of final as-built drawings, finalization of a reconciliation package, and updates to company recordkeeping systems to reflect the completed scope of work.

Pipeline Safety Enhancement Plan Final Report
Supply Line 49-15 Replacement Project

IV. PROJECT COSTS

A. Cost Avoidance Actions

SoCalGas and SDG&E exercised due diligence in the planning, design, and construction activities for this project to minimize or avoid costs when prudent to do so. As discussed above, the Project Team conducted a site visit to identify and incorporate discernible site conditions into the engineering, design, and planning of the Project. Specific examples of cost avoidance actions taken on this project are:

1. Engineering and Design: An alternate route considered by the Project team would have tied the rerouted line into Line 1602. By electing to interconnect with Line 3600, SoCalGas and SDG&E reduced the amount of new pipe, trenching, and the risk of boring under a freeway.
2. Materials: Bulk ordered pipe provided volume pricing for the [REDACTED] pipe.
3. Land Use: Strategic siting of laydown yards allowed for a shorter travel distance for material and equipment transport. The Project Team also utilized shared laydown yards with other projects in the area.
4. Water Management: The Project utilized recycled water for testing and dust control.

B. Cost Estimate

Based on the preliminary design, once the project scope was confirmed and engineering, design, and planning activities were underway, SoCalGas and SDG&E prepared an estimate of the Direct Costs of the Project in the amount of \$51,744,536. This estimate was prepared in February of 2015, using the “Stage 3 San Diego Pipeline Estimate Template Rev 1.0” estimating tool, the most current version of the PSEP Estimate Template at the time. The Project Team considered the conditions known at the time to prepare the preliminary Direct Cost estimate. This estimate reflects the

Pipeline Safety Enhancement Plan Final Report
Supply Line 49-15 Replacement Project

projected Labor, Material, and Services costs anticipated to be incurred to execute the Project.

SoCalGas and SDG&E estimated Indirect Costs of the Project based on the estimated Direct Costs and other project-related variables.

C. Actual Direct and Indirect Costs

Actual Direct Costs reflect the Labor, Material and Service costs incurred to execute the Project. Actual Indirect Costs reflect costs for incremental overhead loaders in accordance with Company overhead allocation policies. The total loaded cost of the Project is \$43,488,794.

Table 4: Estimated and Actual Direct Costs and Variances

Direct Costs (\$)	Estimate	Actuals	Delta Over/(Under)
Company Labor	1,420,941	680,857	(740,084)
Materials	1,716,937	1,614,069	(102,868)
Construction Contractor	35,853,970	21,028,132	(14,825,838)
Construction Management & Support	1,430,035	3,371,891	1,941,856
Environmental	1,251,688	637,571	(614,117)
Engineering & Design	3,262,407	5,804,699	2,542,292
Project Management & Services	1,590,573	870,187	(720,386)
ROW & Permits	1,125,534	1,295,819	170,285
GMA	4,092,451	2,859,150	(1,233,301)
Total Direct Costs	51,744,536	38,162,375	(13,582,161)

Pipeline Safety Enhancement Plan Final Report
Supply Line 49-15 Replacement Project

Table 5: Estimated and Actual Indirect Costs, Total Costs, and Variances

Indirect Costs/Total Costs (\$)	Estimate	Actuals	Delta Over/(Under)
Overheads	7,684,620	3,851,116	(3,833,504)
AFUDC	4,156,793	1,254,013	(2,902,780)
Property Taxes	5,855,528	221,290	(5,634,238)
Total Indirect Costs	17,696,941	5,326,419	(12,370,522)
Total Direct Costs	51,744,536	38,162,375	(13,582,161)
Total Loaded Costs	69,441,477	43,488,794	(25,952,683)

D. Disallowance

There was no disallowance calculation for the Supply Line 49-15 Replacement Project as there were no post-1955 segments included in the Project without records that provide the minimum information to demonstrate compliance with then applicable industry standards or regulatory strength testing and recordkeeping requirements.

Pipeline Safety Enhancement Plan Final Report
Supply Line 49-15 Replacement Project

V. CONCLUSION

SoCalGas and SDG&E enhanced the safety of their natural gas transmission system by prudently executing the Supply Line 49-15 Replacement Project. Through this Replacement Project, SoCalGas and SDG&E successfully installed 2.79 miles of pipeline in the City of La Mesa and City of El Cajon. The total loaded cost of the Project is \$43,488,794.

SoCalGas and SDG&E executed this project prudently by reducing the total length of pipe installed, while maintaining reliable service to customers.

SoCalGas and SDG&E engaged in prudent cost avoidance efforts by using reclaimed water for testing, sharing a laydown yard, and taking advantage of cost savings from favorable pricing of bulk purchased pipe.

End of Supply Line 49-15 Replacement Project Final Report

Pipeline Safety Enhancement Plan Final Report
Final Report for Supply Line 49-28 Replacement Project

I. SUPPLY LINE 49-28 REPLACEMENT PROJECT

A. Background and Summary

Supply Line 49-28 is a [REDACTED] diameter transmission pipeline that runs approximately seven miles alongside Interstate 5 through a heavily developed section of western San Diego. The pipeline is primarily routed across a Class 3 location. This report describes the activities associated with the Supply Line 49-28 Replacement Project, which consists of the replacement and reroute of 2.600 miles of pipeline with new [REDACTED] diameter pipe, two new [REDACTED] mainline valves (MLVs), the abandonment of a regulator station, and the installation of a new regulator station. Portions of the replacement pipe consist of two jack-and-bore crossings under Interstate 5 and Tecolote Creek. The specific attributes of this Project are detailed in Table 1 below. The total loaded cost of the Project is \$46,990,042.

The new pipe installed as part of the Supply Line 49-28 Project ties in to Supply Line 49-11 and is considered a lateral of that supply line. Following completion of this project, the replacement pipeline was renamed and is now identified as Supply Line 49-11-J.

Pipeline Safety Enhancement Plan Final Report
Final Report for Supply Line 49-28 Replacement Project

Table 1: General Project Information

Project Name	Supply Line 49-28		
Project Type	Replacement		
Length	2,600 miles		
Location	San Diego		
Class	3		
MAOP (<i>confidential</i>)	[REDACTED]		
Predominant Pipe Vintage	1932		
Construction Start	09/08/2014		
Construction Finish	09/30/2016		
Original Pipe Diameter (<i>confidential</i>)	[REDACTED]		
New Diameter (<i>confidential</i>)	[REDACTED]		
Original SMYS ¹ (<i>confidential</i>)	[REDACTED]		
New SMYS (<i>confidential</i>)	[REDACTED]		
Project Costs (\$)	Capital	O&M	Total
Loaded Project Costs	46,990,042	0	46,990,042
Disallowed Costs	0	0	0

¹ Highest percentage of Specified Minimum Yield Strength (SMYS) of Category 4 Criteria pipe.

Pipeline Safety Enhancement Plan Final Report
Final Report for Supply Line 49-28 Replacement Project

B. Maps and Images

Figure 1: Satellite Image of Supply Line 49-28 Replacement Project

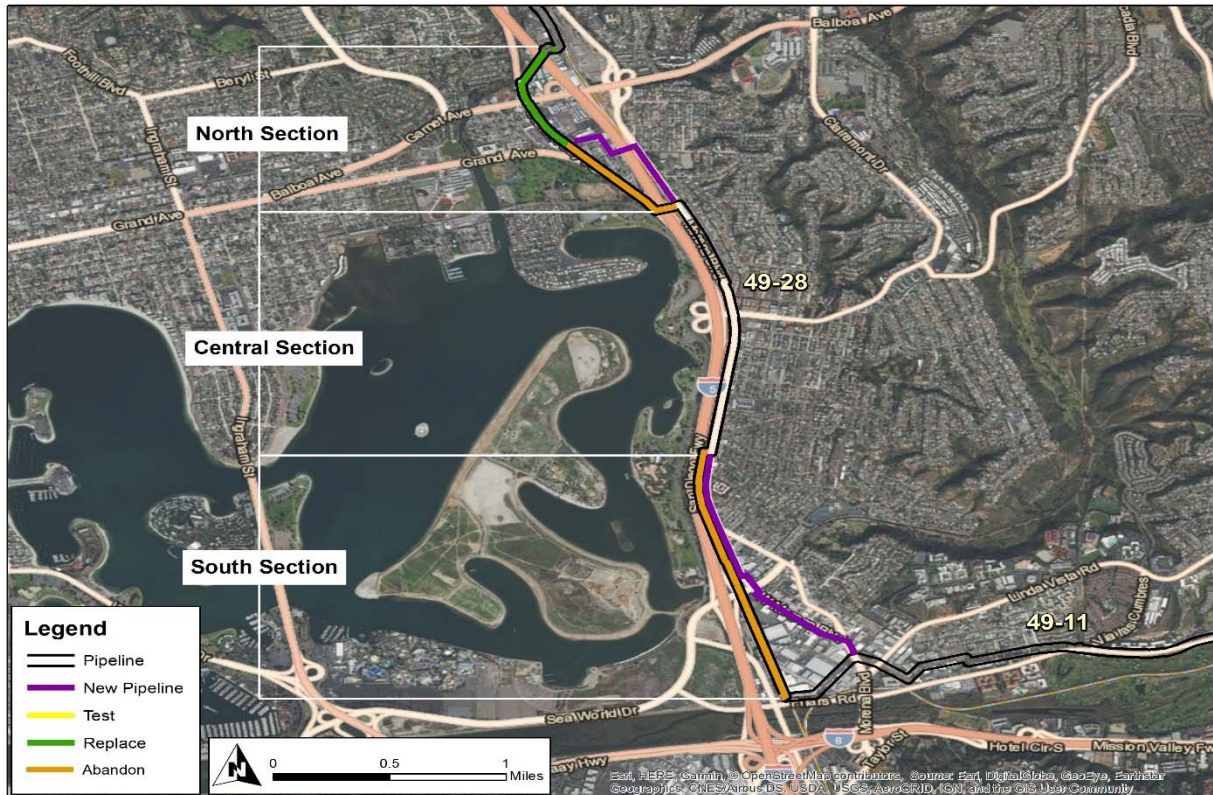

Pipeline Safety Enhancement Plan Final Report Final Report for Supply Line 49-28 Replacement Project

Figure 2: Overview Map of Supply Line 49-28 Replacement Project

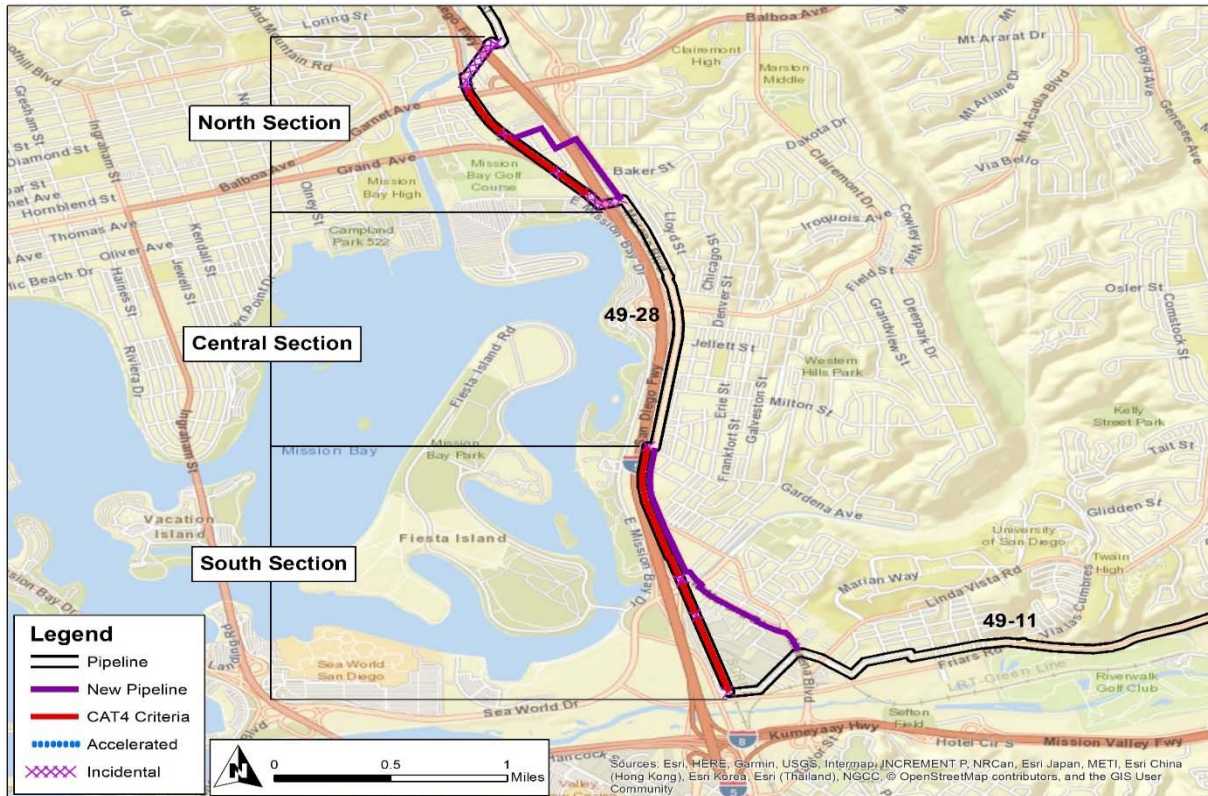

Pipeline Safety Enhancement Plan Final Report
Final Report for Supply Line 49-28 Replacement Project

Figure 3: Satellite Image of Supply Line 49-28 South Section Replacement Project

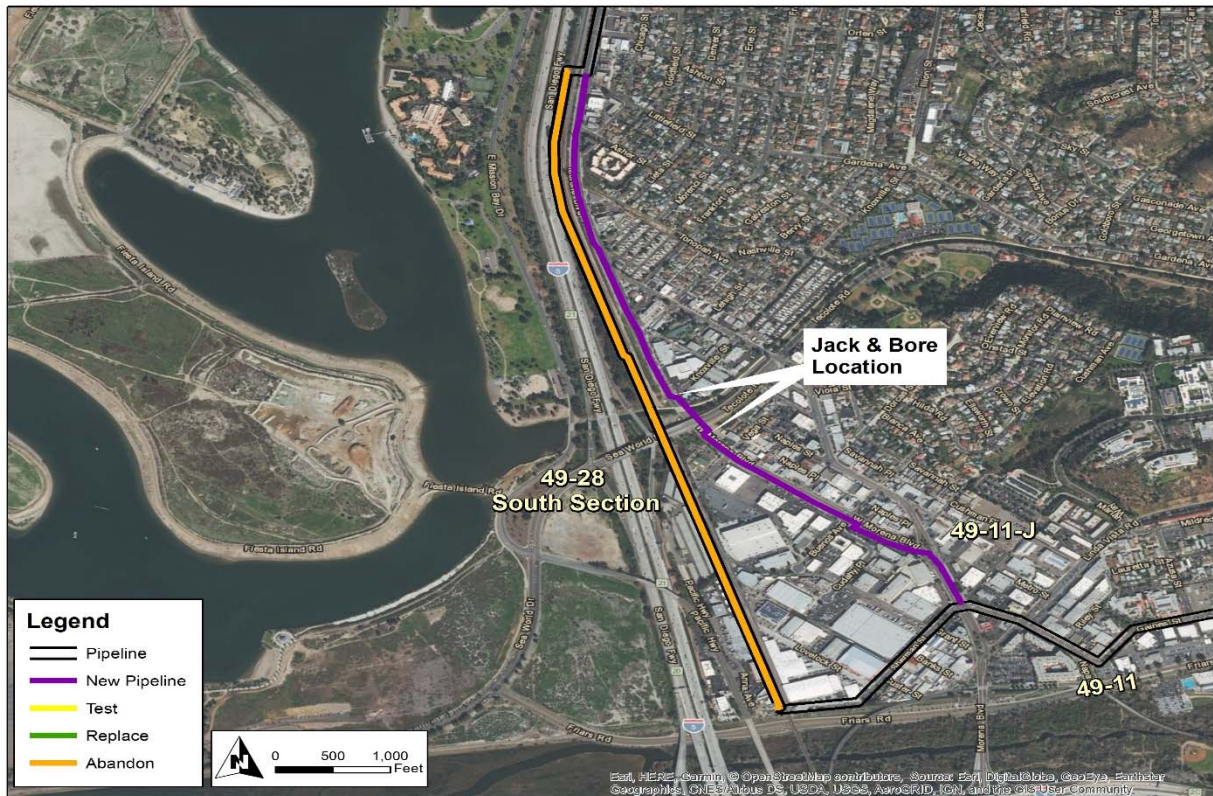

Pipeline Safety Enhancement Plan Final Report
Final Report for Supply Line 49-28 Replacement Project

Figure 4: Overview Map of Supply Line 49-28 South Section Replacement Project

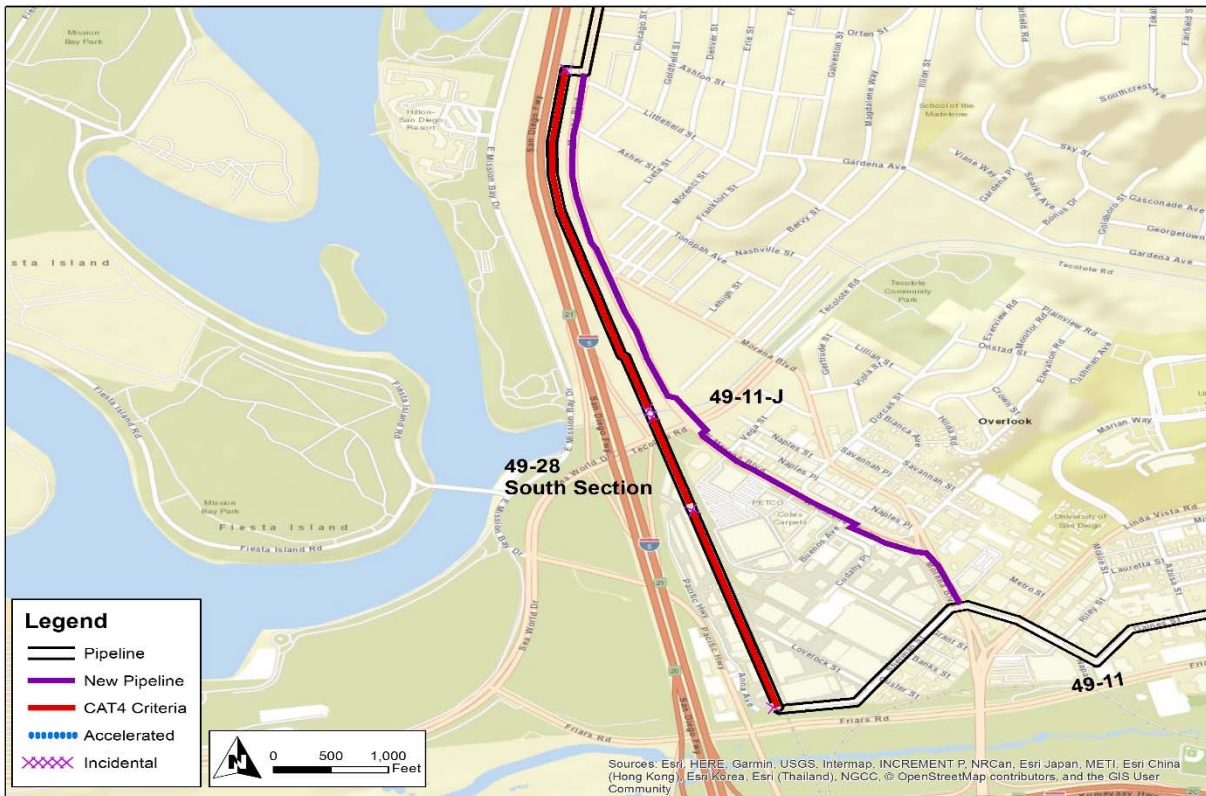

Pipeline Safety Enhancement Plan Final Report
Final Report for Supply Line 49-28 Replacement Project

Figure 5: Satellite Image of Supply Line 49-28 North Section Replacement Project

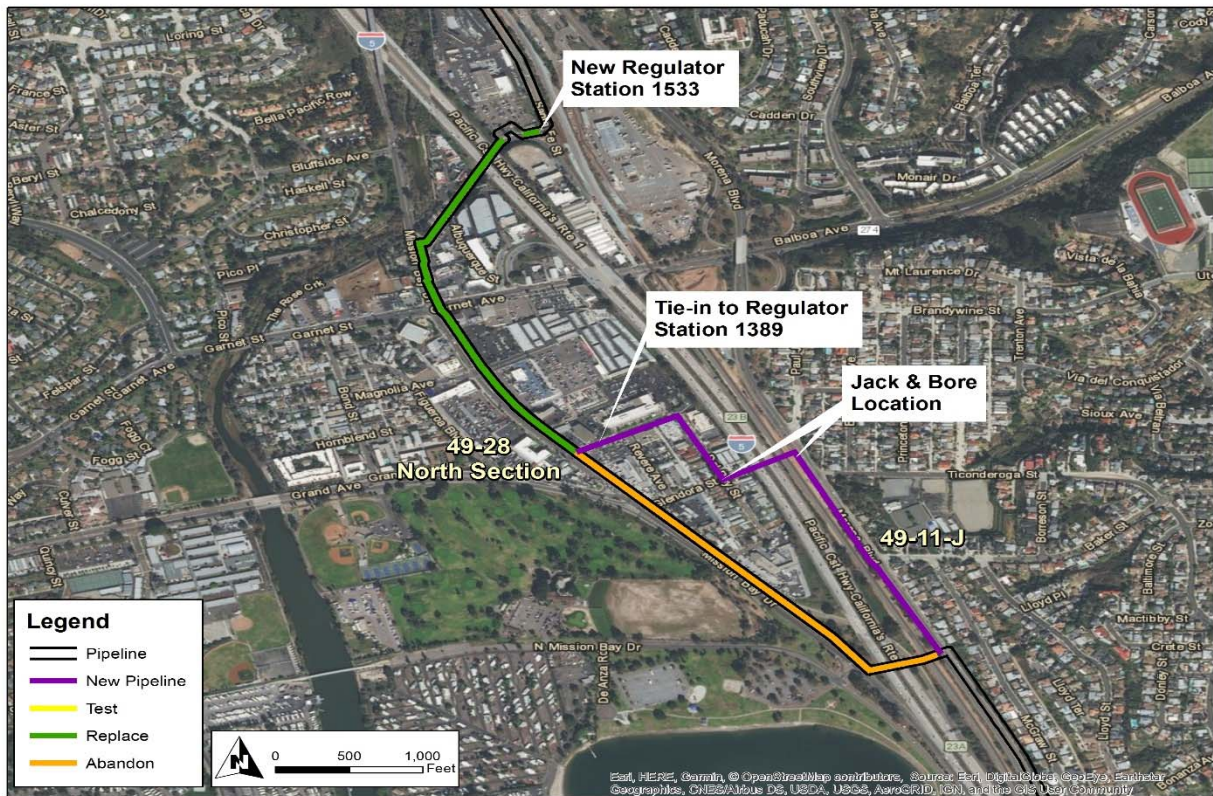

Pipeline Safety Enhancement Plan Final Report
Final Report for Supply Line 49-28 Replacement Project

Figure 6: Overview Map of Supply Line 49-28 North Section Replacement Project

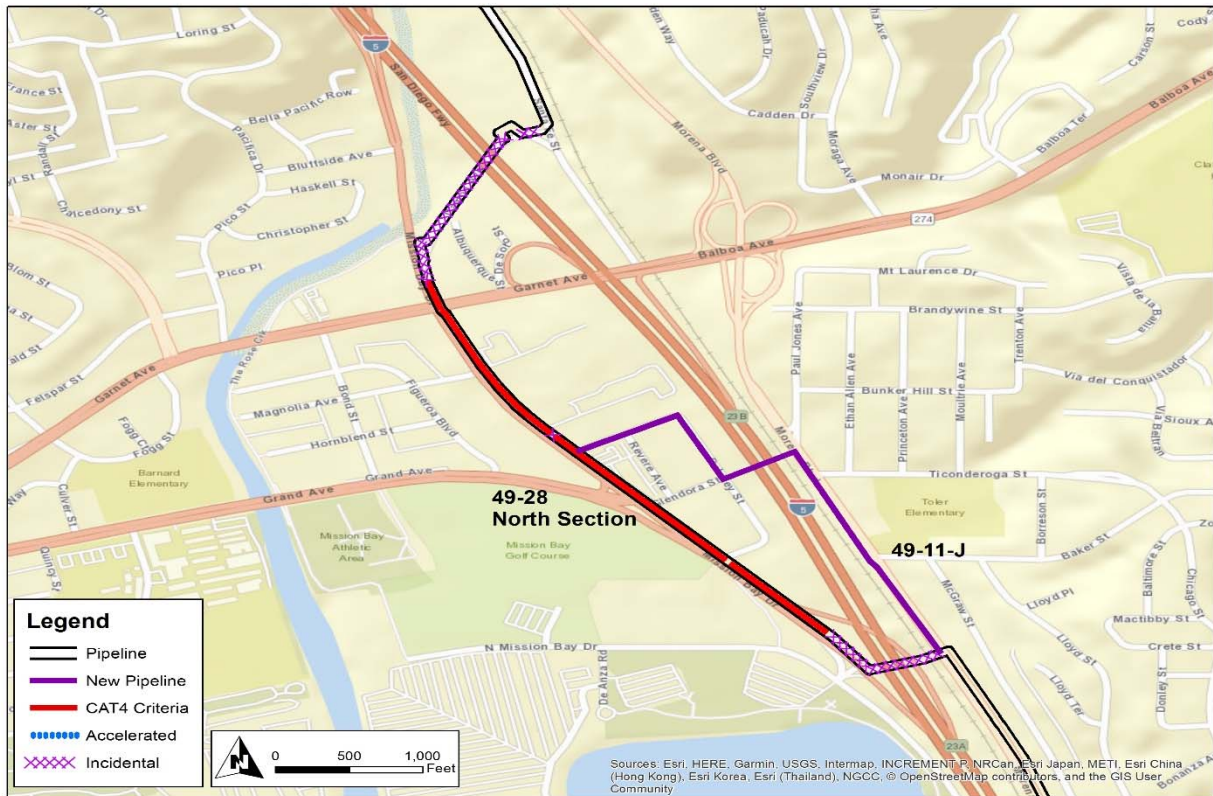

Pipeline Safety Enhancement Plan Final Report
Final Report for Supply Line 49-28 Replacement Project

II. ENGINEERING, DESIGN, AND PLANNING

A. Project Scope

Table 2: Mileage Information

	Criteria	Accelerated ²	Incidental	New	Total ³
Final Mileage	1.964 mi.	0.002 mi.	0.467 mi.	0.167 mi.	2.600 mi.
	10,370 ft.	11 ft.	2,466 ft.	882 ft.	13,729 ft.

SoCalGas and SDG&E presented a conceptual project scope in workpapers supporting the 2011 PSEP filing.⁴ Prior to initiating execution of the Project in 2014, SoCalGas and SDG&E reviewed existing pipeline records to validate the scope of the Project. During the Engineering, Design, and Planning phase, SoCalGas and SDG&E further refined the scope. The progression of the project scope is summarized as follows:

1. 2011 PSEP Filing: SoCalGas and SDG&E identified Supply Line 49-28 as a Phase 1A Replacement Project comprised of 1.796 miles of Category 4 Criteria pipe and 3.099 miles of Accelerated pipe.
2. Scope Validation: Through scope validation activities, after the 2011 filing and before initiating execution of the Project, SoCalGas and SDG&E increased the scope of the Project by 0.168 miles of Category 4 Criteria pipe.

² Accelerated mileage includes Phase 2B pipe. Phase 2B includes pipelines with record of a pressure test, but without record of a pressure test to modern – Subpart J – standards (Phase 2B). The Accelerated mileage was included to realize efficiencies and to enhance project constructability.

³ Values may not add to total due to rounding.

⁴ See Amended PSEP of SoCalGas and SDG&E, submitted December 2, 2011, in R.11-02-019 and subsequently transferred to A.11-11-002.

Pipeline Safety Enhancement Plan Final Report
Final Report for Supply Line 49-28 Replacement Project

3. Engineering, Design, and Constructability:

- a. For constructability and project management purposes the Project was designed to be executed in three sections:
 - i. The North Section scope of work includes replacing and rerouting the pipeline and adding a new regulator station.
 - ii. The South Section scope of work includes replacing and rerouting the pipeline and abandoning a regulator station.
 - iii. The Central Section scope of work includes actions taken to uprate the pipe to match the pressure of the replacement pipe in the North Section and South Section with that of Supply Line 49-11.
- b. The Project Team removed a regulator station in the South Section and installed a new regulator station in the North Section between the new pipeline and the existing Supply Line 49-28 to reduce pressure from [REDACTED] to [REDACTED]
- c. The Project Team planned and designed two jack-and-bore crossings, under Tecolote Creek in the South Section, and under a railroad and Interstate 5 in the North Section.
- d. The Project Team reduced the pipe diameter to make the new pipeline uniform with the existing Central Section, and compatible with the planned uprate.
- e. Accelerated Phase 2B mileage was included to complete the tie-in to Supply Line 49-11.
- f. Incidental mileage was included to facilitate constructability and system reliability to the new line.

Pipeline Safety Enhancement Plan Final Report
Final Report for Supply Line 49-28 Replacement Project

4. Final Project Scope: The final project scope consists of a 2.6-mile replacement, installation of two new MLVs, installation of a new regulator station, and tie-ins to three existing regulator stations. The Accelerated mileage consists of 11 feet of Phase 2B pipe and 0.467 miles of Incidental pipe.

B. Decision Tree Analysis

SoCalGas and SDG&E performed a PSEP Decision Tree analysis of Supply Line 49-28 and confirmed the project design should commence as a Replacement Project.

Pipeline segments installed prior to 1946 that are not capable of being assessed using in-line inspection technology are identified for replacement under the approved PSEP Decision Tree. As explained in the testimony supporting the approved PSEP, as part of the work previously completed during implementation of federal gas transmission pipeline integrity management regulations (49 CFR 192, Subpart O), SoCalGas and SDG&E have already identified, retrofitted and in-line inspected pre-1946 transmission pipelines that were constructed using acceptable welding techniques and are operationally suited to in-line inspection. The remaining pre-1946 segments in the SoCalGas/SDG&E system are generally not suited for in-line inspection, likely have non-state-of-the-art welds, and would require significant investment for retrofitting to accommodate in-line inspection tools. Accordingly, consistent with the Commission's directive in D.11-06-017 to "address retrofitting pipeline to allow for inline inspection tools," the requirement in California Public Utilities Code section 958 that upon completion of the PSEP, where warranted, pipelines are to be capable of accommodating in-line inspection devices, and the overarching objectives of PSEP to enhance the safety of the pipeline system in a proactive, cost effective manner, the approved PSEP Decision Tree identifies pre-1946 non-piggable pipeline segments for abandonment and/or replacement.

Pipeline Safety Enhancement Plan Final Report
Final Report for Supply Line 49-28 Replacement Project

Through this Decision Tree analysis, SoCalGas and SDG&E identified replacement as the more prudent option. Key considerations that support SoCalGas and SDG&E's determination to replace the North Section and South Section of pipeline include:

1. Shut-In Analysis: The Project Team completed a Request for Engineering Review (RER) analysis and concluded the pipeline could not be shut-in due to customer impacts.
2. Customer Impacts: The existing pipeline serves four regulator stations that feed approximately 29,000 customers.
3. Piggability: Non-piggable.
4. Pipe Vintage: 1932.
5. Existing Pipe Attributes: Pressure control fittings (PCFs), bottom out fittings, and diameter changes greater than one nominal pipe size.
6. Other Identified Risks: SoCalGas and SDG&E determined through data analysis that this pipeline could not be subjected to the elevated test pressures.

C. Engineering, Design, and Planning Factors

SoCalGas and SDG&E reviewed pipeline drawings and other information, contacted internal planning groups, communicated with external stakeholders, conducted survey activities, including reviewing public records and potholing of the area to confirm the presence of underground utilities and substructures, and completed a pre-design site walk. Key factors that influenced the engineering and design of the Project are as follows:

1. Shut-In Analysis: As discussed above, the Project Team completed an RER analysis and concluded the line could not be shut-in with manageable customer impacts and that reliability of service to customers would need to be maintained.

Pipeline Safety Enhancement Plan Final Report
Final Report for Supply Line 49-28 Replacement Project

Furthermore, the RER analysis recommended that the newly-installed line be placed into service before abandonment of the preexisting pipeline.

2. Customer Impacts: Per the RER, the Project Team planned to maintain customer service through strategic construction sequencing, gas handling plans, and utilizing PCFs. The Project Team designed temporary bypass lines to serve critical areas where service to customers could not be interrupted.
3. Community Impacts: Construction activity on Morena Boulevard and Mission Bay Drive would impact access to residential, business, university, and recreational areas. Work on the pipeline required mitigating traffic impacts through temporary traffic control, night work, and coordination with local residents and businesses.
4. Diameter Changes: The original existing pipeline was [REDACTED] in diameter. SoCalGas and SDG&E analyzed typical load demands and future capacity planning for a replacement diameter of [REDACTED] and determined that to be sufficient.
5. Reroute: In its preexisting alignment, Supply Line 49-28 was difficult to access for routine repairs and maintenance because it was in a heavily congested corridor running between private property and adjacent to railroad tracks. Both sections tie-in to the Central Section that is approximately 1.4 miles of existing newer [REDACTED] pipe, along Morena Boulevard.
 - a. The existing alignment in the South Section of Supply Line 49-28 had a majority of the pipeline adjacent to a Metropolitan Transit System (MTS) railroad corridor that crosses through many private properties.

Pipeline Safety Enhancement Plan Final Report
Final Report for Supply Line 49-28 Replacement Project

A future MTS railroad improvement project would have required relocation of the pipeline had the Project Team selected to replace the pipeline in the preexisting alignment adjacent to MTS right-of-way (ROW). Therefore, the Project Team determined a reroute was necessary. In addition, the Project Team improved accessibility to the pipeline by relocating the alignment from the congested area to existing public ROW. The new South Section ties-in directly to Supply Line 49-11 and runs along Morena Boulevard to tie in to the Central Section.

- b. The existing alignment in the North Section of Supply Line 49-28 crosses under Caltrans ROW, traverses along Mission Bay Drive, sidewalks, and driveways to private properties ending at the corner of Damon Avenue and Santa Fe Street. The Project Team changed the alignment by installing approximately 0.341 miles from the Central Section before crossing Interstate 5. The new alignment is routed along Del Rey Street, Bunker Hill Street, Mission Bay Drive, and Damon Avenue. The new line ties-in to a new regulator station at SoCalGas and SDG&E's Beach Cities Station at Damon Avenue to regulate the pressure of the new pipeline and match the pressure of the existing. This improved accessibility for routine maintenance, avoided community impacts to pedestrian sidewalks and business driveways.

- 6. Uprate: The system capacity could be efficiently increased by raising the pressure of the entire length of the pipeline from the South Section, where Supply Line 49-28 ties in to Supply Line 49-11, to the North Section, connecting at Beach Cities Station. The MAOP would be increased from [REDACTED] to [REDACTED]

- a. The Central Section is approximately 1.4 miles of non-Criteria pipe. The Project Team planned to hydrotest the Central Section to validate that it could operate safely at a higher pressure.

Pipeline Safety Enhancement Plan Final Report
Final Report for Supply Line 49-28 Replacement Project

- b. The Project Team removed the regulator station at the connection point with Supply Line 49-28 since it was no longer needed to reduce the pressure delivered from Supply Line 49-32 to Supply Line 49-28.
 - c. The Project Team identified a new regulator station to be installed at the North Section where Supply Line 49-28 connects with the Beach Cities Station to regulate pressure from [REDACTED] to [REDACTED]
7. Constructability: The Project Team designed the Project to be executed in three sections to efficiently manage construction on the non-contiguous North Section and South Section. The North Section and South Section includes replacing and rerouting the pipeline, and the relocation of a regulator station. The Central Section includes the activities to uprate the existing pipeline.
- a. South Section: The Project Team designed the route outside the railroad corridor and along existing easements, through less congested city streets.
 - i. The Project Team utilized a horizontal directional drill (HDD) to cross under Tecolote Canal and tie in to Supply Line 49-11.
 - ii. One regulator station was removed, since the new pipeline would be operating at a higher pressure.
 - iii. The pipe designated for abandonment would continue to be operated at a lower pressure until the abandonment activity could be coordinated with the abandonment of Supply Line 49-25 and Supply Line 49-26.
 - b. North Section: The Project Team designed the route outside of sidewalks and private properties.

Pipeline Safety Enhancement Plan Final Report Final Report for Supply Line 49-28 Replacement Project

- i. The Project Team designed the new route along Morena Boulevard and crossing under Interstate 5, using jack-and-bore, and along Mission Bay Drive, ending at the SDG&E Beach Cities base on Damon Avenue.
 - ii. The Project Team installed a regulator station at the Beach Cities Station due to the pressure increase on the new pipeline. The Project Team selected this location to avoid acquiring additional property and easements and utilize existing SDG&E property.
 - iii. The Project Team included approximately 0.227 miles of Incidental pipe in the North Section to avoid lengthy tie-in work on Mission Bay Drive and to maintain the new [REDACTED] diameter throughout the new line up to the new regulator station. The Project Team determined that having a consistent diameter in the new line enabled pigging.
- c. Phasing: The Project Team split the Project into five phases. The Project Team decided this was necessary as some phases required more complex gas handling, property negotiations, and permit acquisitions. The majority of the Project was executed in the order that the permits were authorized and approved. See Figure 8 below.
- i. Phase 1 included the installation of approximately 1.6 miles of pipe along Morena Boulevard (the South Section and a portion of the North Section).
 - ii. Phase 2 included pressure testing the pipe installed in Phase 1, completed in two tests (the South Section and the portion installed on Morena Boulevard of the North Section).
 - iii. Phase 3 included the installation and testing of pipe west of Interstate 5 (North Section).

Pipeline Safety Enhancement Plan Final Report
Final Report for Supply Line 49-28 Replacement Project

- iv. Phase 4 included the installation and testing of additional pipe to tie into Supply Line 49-11 (South Section), and the jack-and-bore across Interstate 5 (North Section).
- v. Phase 5 included the uprate of the existing pipe and completing the remaining tie-ins to existing pipe and regulator stations within the North Section, Central Section and South Section.

Pipeline Safety Enhancement Plan Final Report
Final Report for Supply Line 49-28 Replacement Project

8. Diameter Changes: The original existing pipeline had a [REDACTED] diameter. SoCalGas and SDG&E analyzed typical load demands and future capacity planning for a replacement diameter of [REDACTED] and determined that to be sufficient, so long as the pressure was increased to maintain the existing capacity of the system.
9. Valves: The Project Team installed a new [REDACTED] MLV at the branch location of Supply Line 49-11 and replaced a [REDACTED] valve with a [REDACTED] valve on Bunker Hill Street to match the change in pipe diameter.
10. Land Use: The Project Team secured private property close to the alignment to use as laydown yards or excavation sites. The Project Team was unsuccessful in negotiating a land agreement for a parking lot to be used as the bore pit on the west side of the Interstate 5 crossing. Ownership of the property changed hands during the negotiations. SoCalGas and SDG&E needed to use condemnation rights to secure the property.
11. Permits:
 - a. A Caltrans encroachment permit was required for the jack-and-bore crossing under Interstate 5.
 - b. The Project design required an encroachment permit from San Diego MTS, and its sister agency North County Transit District. These two agencies own the railroad corridor between Interstate 5 and Morena Boulevard. The permit required separate reviews from both agencies.
 - c. The Project Team acquired noise permits from the City of San Diego for night time construction activities and encroachment permits for all the work activity planned within city ROW.

Pipeline Safety Enhancement Plan Final Report
Final Report for Supply Line 49-28 Replacement Project

D. Scope Changes

Through engineering, design, and planning activities, SoCalGas and SDG&E determined that changes in scope were appropriate to enhance the design of the Project and address engineering factors. As a result, the preliminary cost estimate does not fully reflect the final scope. Summarized below are notable changes in scope made after the preliminary cost estimate was developed and approved.

1. The Project Team descope the Central Section Hydrotest after reviewing operating records for Supply Line 49-28 that supported being able to operate the Central Section at higher pressures and eliminated the need for a hydrotest.
2. The preliminary estimate included an HDD under Tecolote Creek in the South Section based on early preliminary design drawings. The Project Team rescope the HDD to a jack and bore to reflect constructability reviews as the detailed design package was developed.

Pipeline Safety Enhancement Plan Final Report
Final Report for Supply Line 49-28 Replacement Project

III. CONSTRUCTION

A. Construction Contractor Selection

The Project Team prepared an initial cost estimate based on the preliminary design. Following completion of the engineering, design, and planning activities described above, the Project Team directed the Performance Partner to prepare a cost estimate based on a more detailed engineering design package, that included the updated design as described in the discussion of notable Scope Changes above. SoCalGas and SDG&E awarded the construction contract to the Performance Partner.

1. SoCalGas and SDG&E's Preliminary Construction Cost Estimate (confidential): SoCalGas and SDG&E's preliminary estimate for construction was [REDACTED].
2. Construction Contractor's Target Price Estimate (confidential): The Construction Contractor's cost estimate was [REDACTED], which was [REDACTED] than SoCalGas and SDG&E's preliminary cost estimate for construction.

B. Construction Schedule

Table 3: Construction Timeline

Construction Start Date	09/08/2014
Construction Completion Date	09/30/2016
NOP Date	07/18/2016

C. Changes During Construction

The conditions summarized below were encountered during construction. Activities to address or mitigate these conditions resulted in approximately \$2,800,000 in change orders.

1. Schedule Delay: The Project experienced many unanticipated conditions that resulted in schedule delays which were managed through the phased construction

Pipeline Safety Enhancement Plan Final Report
Final Report for Supply Line 49-28 Replacement Project

activities discussed above, which resulted in the construction duration increasing from the original plan of 16 weeks to 107 weeks. Additional field support costs were incurred to support the completion of this project. Causes for schedule delay were:

- a. The Project schedule was severely impacted by negotiations for a parking lot that the project team intended to use for the jack-and-bore receiving pit in the North Section. The major factor contributing to the difficulty acquiring this land was a change of ownership of the property. The Project Team was unsuccessful in negotiating an agreement and it took over 18 months to gain access after SoCalGas and SDG&E exercised their condemnation right to secure the property.
 - b. Construction activities shifted from day work to night work or weekends due to agency requests or community impact mitigation. These night time construction activities incurred additional premiums in labor rates, equipment rentals, and reduced work area that diminished productivity.
 - c. Reordered materials and additional materials beyond what the Project Team originally designed affected the duration of the Project. The schedule delay was due to long lead times in acquiring the necessary materials and the time to prepare and review engineering documents. Additionally, the Project Team repaired materials that arrived damaged.
2. Customer Impact Mitigation: The Project Team maintained customer service by locating and exposing a service tee to install a bypass between the regulator stations. This required extra excavations, additional material for the bypass line and backfill.

Pipeline Safety Enhancement Plan Final Report
Final Report for Supply Line 49-28 Replacement Project

Figure 8: Night Work on Mission Bay Drive



Pipeline Safety Enhancement Plan Final Report
Final Report for Supply Line 49-28 Replacement Project

D. Commissioning and Site Restoration

Commissioning activities include restoration of the site, final inspection and placement of the pipeline back into service, transportation and disposal of the hydrotested water and hazardous material, and site demobilization.

Closeout activities include development of final as-built drawings, finalization of a reconciliation package, and updates to company recordkeeping systems to reflect the completed scope of work.

Pipeline Safety Enhancement Plan Final Report
Final Report for Supply Line 49-28 Replacement Project

IV. PROJECT COSTS

A. Cost Avoidance Actions

SoCalGas and SDG&E exercised due diligence in the planning, design, and construction activities for this project to minimize or avoid costs when prudent to do so. As discussed above, the Project Team conducted a site visit to identify and incorporate discernible site conditions into the engineering, design, and planning of the Project. Specific examples of cost avoidance actions taken on this project are:

1. Materials: The Project Team reduced the pipe diameter from [REDACTED] diameter to [REDACTED] diameter pipe, yielding savings in terms of both material and construction costs. In addition, bulk ordering provided volume pricing for the [REDACTED] pipe.
2. Water Management: The Project Team reused the water and stored the water onsite while not in use, to avoid transportation costs.
3. Future Maintenance: The decision to reroute the pipeline in the South Section avoided the cost of having to remove the pipe from the railroad corridor. Early planning for railroad corridor improvements was conducted, and if the preexisting pipeline alignment were utilized, there would have been future costs to relocate the pipeline to accommodate several utility relocations in the area.

B. Cost Estimate

Based on the preliminary design, once the project scope was confirmed and engineering, design, and planning activities were underway, SoCalGas and SDG&E prepared an estimate of the Direct Costs of the Project in the amount of \$17,677,539.

Pipeline Safety Enhancement Plan Final Report
Final Report for Supply Line 49-28 Replacement Project

This estimate was prepared in April of 2014, using the “SCG Pipeline Estimate Template Rev 0” estimating tool, the most current version of the PSEP Estimate Template at the time. The Project Team considered the conditions known at the time to prepare the preliminary Direct Cost estimate. This estimate reflects the projected Labor, Material, and Services costs anticipated to be incurred to execute the Project.

SoCalGas and SDG&E estimated Indirect Costs of the Project based on the estimated Direct Costs and other project-related variables.

C. Actual Direct and Indirect Costs

Actual Direct Costs reflect the Labor, Material and Service costs incurred to execute the Project. Actual Indirect Costs reflect costs for incremental overhead loaders in accordance with Company overhead allocation policies. The total loaded cost of the Project is \$46,90,042.

Table 4: Estimated and Actual Direct Costs and Variances

Direct Costs (\$)	Estimate	Actuals	Delta Over/(Under)
Company Labor	1,484,175	955,349	(528,826)
Materials	1,550,682	1,311,657	(239,025)
Construction Contractor	9,374,132	21,785,204	12,411,072
Construction Management & Support	222,194	3,706,818	3,484,624
Environmental	505,810	897,997	392,187
Engineering & Design	2,069,991	4,912,068	2,842,077
Project Management & Services	604,596	1,158,774	554,178
ROW & Permits	392,027	763,679	371,652
GMA	1,473,932	2,926,782	1,452,850
Total Direct Costs	17,677,539	38,418,328	20,740,789

Pipeline Safety Enhancement Plan Final Report
Final Report for Supply Line 49-28 Replacement Project

Table 5: Estimated and Actual Indirect Costs, Total Costs, and Variances

Indirect Costs/Total Costs (\$)	Estimate	Actuals	Delta Over/(Under)
Overheads	3,834,999	5,039,760	1,204,761
AFUDC	269,594	3,008,529	2,738,935
Property Taxes	-	523,425	523,425
Total Indirect Costs	4,104,593	8,571,714	4,467,121
Total Direct Costs	17,677,539	38,418,328	20,740,789
Total Loaded Costs	21,782,132	46,990,042	25,207,910

D. Disallowance

There is no disallowance calculation for the Supply Line 49-28 Project, as there were no post-1955 segments included in the Project without records that provide the minimum information to demonstrate compliance with industry standards or regulatory strength testing and recordkeeping requirements then applicable.

Pipeline Safety Enhancement Plan Final Report
Final Report for Supply Line 49-28 Replacement Project

V. CONCLUSION

SoCalGas and SDG&E enhanced the safety of their integrated natural gas transmission system by prudently executing the Supply Line 49-28 Replacement Project. Through this Replacement Project, SoCalGas and SDG&E successfully replaced 2.6 miles of pipe in the City of San Diego. The total loaded cost of the Project is \$46,990,042.

SoCalGas and SDG&E executed this project prudently by rerouting the pipeline to avoid possible future relocation of the pipeline and provided an alternative feed to three major areas, should the pipeline need maintenance.

SoCalGas and SDG&E engaged in prudent cost avoidance efforts by procuring material using bulk pricing, sharing land with concurrent projects, and reusing the large volume of water needed to test the different sections of the Project.

End of Supply Line 49-28 Replacement Project Final Report

Pipeline Enhancement Safety Final Report
Line 85 South Newhall Avenue Replacement Project

I. LINE 85 SOUTH NEWHALL AVENUE REPLACEMENT PROJECT

A. Background and Summary

Line 85 South is a predominantly [REDACTED] diameter transmission line that runs approximately 28 miles from Pyramid Lake to Santa Clarita. The pipeline is routed across Class 3 and Class 1 locations. This report describes the activities associated with the Line 85 South Newhall Avenue Replacement Project that consists of the replacement of 0.174 miles of pipeline within Newhall Station and the interconnecting piping. The specific attributes of this Project are detailed in Table 1 below. The total loaded cost of the Project is \$9,879,832.

Table 1: General Project Information

Project Name	Line 85 South Newhall Avenue		
Project Type	Replacement		
Length	0.174 miles		
Location	Santa Clarita		
Class	3		
MAOP ¹ (<i>confidential</i>)	[REDACTED]		
Pipe Vintage	1930		
Construction Start	12/16/2014		
Construction Finish	12/04/2015		
Original Pipe Diameter (<i>confidential</i>)	[REDACTED]		
New Diameter (<i>confidential</i>)	[REDACTED]		
Original SMYS ² (<i>confidential</i>)	[REDACTED]		
New SMYS (<i>confidential</i>)	[REDACTED]		
Project Costs (\$)	Capital	O&M	Total
Loaded Project Costs	9,879,832	-	9,879,832
Disallowed Costs	-	-	-

¹ Highest Maximum Allowable Operating Pressure (MAOP) for the station.

² Highest percentage of Specified Minimum Yield Strength (SMYS) of Category 4 Criteria pipe.

Pipeline Enhancement Safety Final Report
Line 85 South Newhall Avenue Replacement Project

Maps and Images

Figure 1: Satellite Image of Line 85 South Newhall Avenue Replacement Project



Pipeline Enhancement Safety Final Report
Line 85 South Newhall Avenue Replacement Project

Figure 2: Overview Map of Line 85 South Newhall Avenue Replacement Project

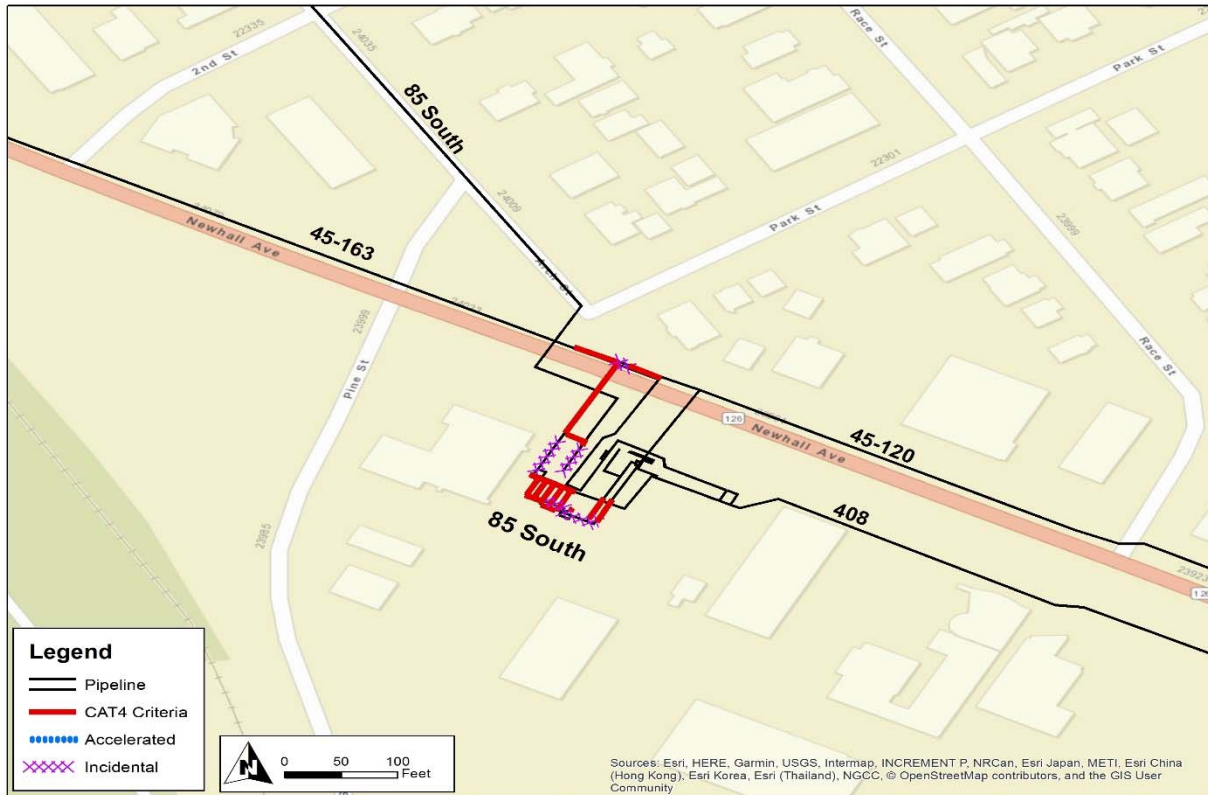

Pipeline Enhancement Safety Final Report
Line 85 South Newhall Avenue Replacement Project

Figure 3: Line 85 South Newhall Avenue Replacement Project Schematic – Before

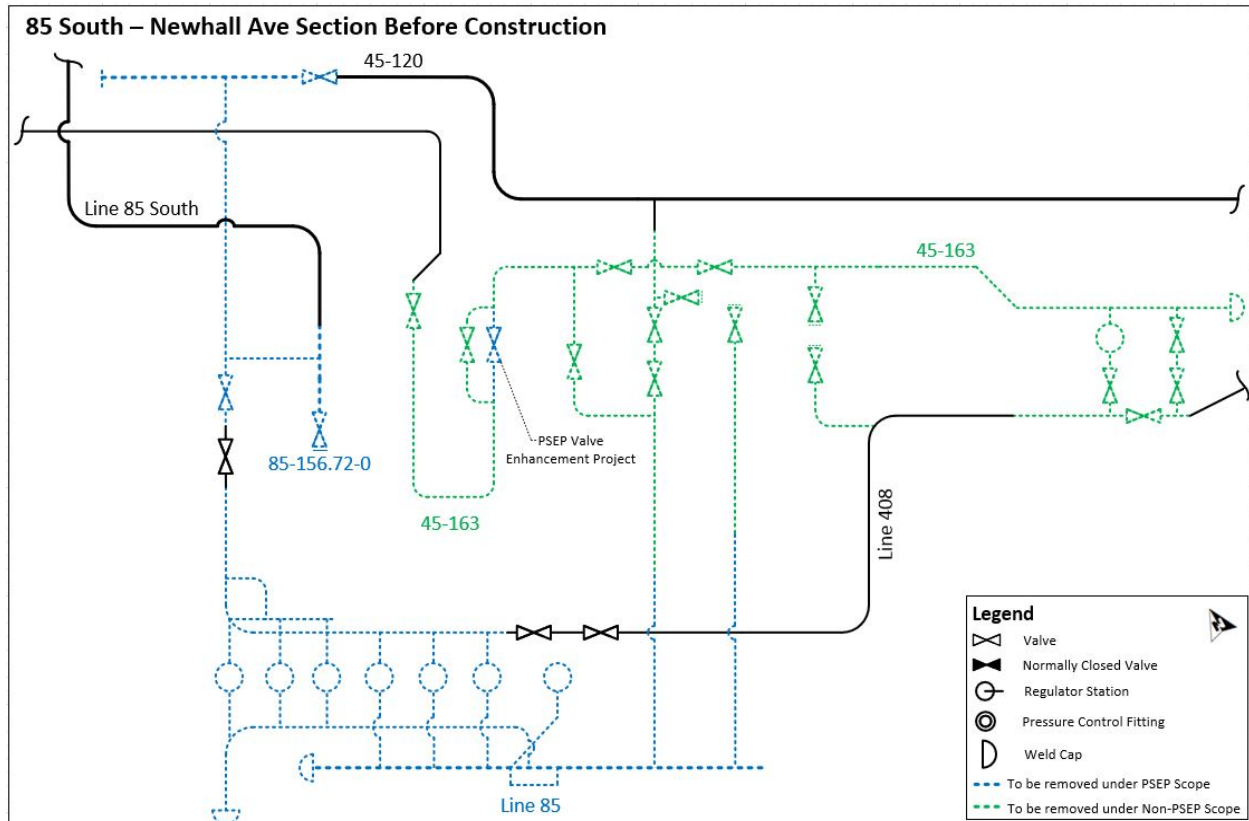

Pipeline Enhancement Safety Final Report Line 85 South Newhall Avenue Replacement Project

Figure 4: Line 85 South Newhall Avenue Replacement Project Schematic – After

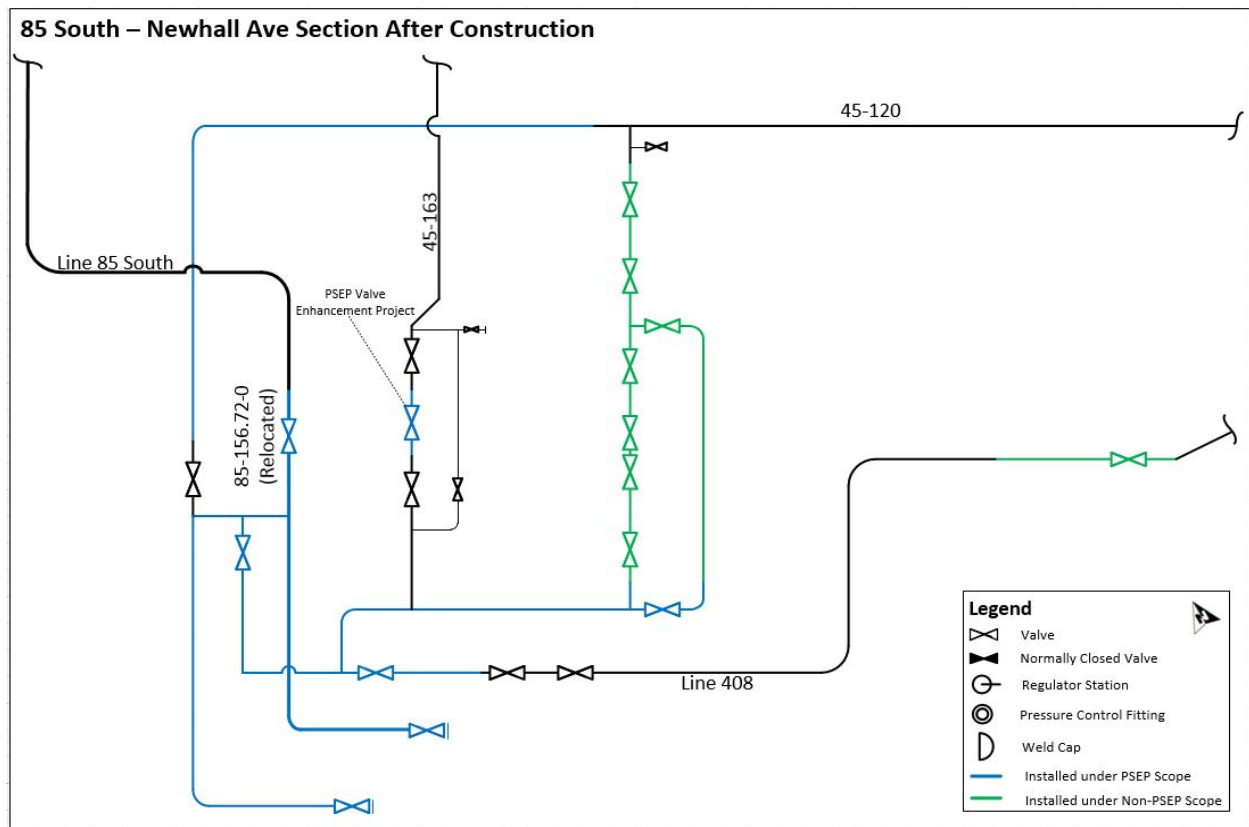

Pipeline Enhancement Safety Final Report
Line 85 South Newhall Avenue Replacement Project

II. ENGINEERING, DESIGN, AND PLANNING

A. Project Scope

Table 2: Mileage Information

	Criteria	Accelerated	Incidental	New	Total ³
Final Mileage	0.087 mi.	0 mi.	0.027 mi.	0.060 mi.	0.174 mi.
	457 ft.	0 ft.	144 ft.	319 ft.	920 ft.

SoCalGas and SDG&E presented a conceptual project scope in workpapers supporting the 2011 PSEP filing.⁴ Prior to initiating execution of the Project in 2014, SoCalGas and SDG&E reviewed existing pipeline records to validate the scope of the Project. During the Engineering, Design, and Planning phase, SoCalGas and SDG&E further refined the scope. The progression of project scope is summarized as follows:

1. 2011 PSEP Filing: SoCalGas and SDG&E did not identify Line 85 South as a Phase 1A Project containing Category 4 Criteria mileage.
2. Scope Validation: Through scope validation activities for the Line 85 South Phase 1B Replacement Project, after the 2011 filing, SoCalGas and SDG&E identified 0.076 miles of Category 4 Criteria pipe. Research conducted on Line 85 South revealed 1931 vintage pipe segments with no test records in service on laterals, crossovers, and interconnect piping within Newhall Station within a Class 3 location.

³ Values may not add to total due to rounding.

⁴ See Amended PSEP of SoCalGas and SDG&E, submitted December 2, 2011, in R.11-02-019 and subsequently transferred to A.11-11-002.

Pipeline Enhancement Safety Final Report
Line 85 South Newhall Avenue Replacement Project

3. Engineering, Design, and Constructability:
 - a. Based on the existing station configuration, Incidental mileage was included to remove the existing scrubbers that were no longer required and enhance piggability. New pipe was added to the replacement to design a station that better accommodated piggability and operability.
4. Final Project Scope: The final project scope consists of a 0.174 mile replacement of station piping that includes 144 feet of Incidental pipe.

B. Decision Tree Analysis

SoCalGas and SDG&E performed a PSEP Decision Tree analysis of Line 85 South Newhall Avenue and confirmed the project design should commence as a Replacement project.

Pipeline segments installed prior to 1946 that are not capable of being assessed using in-line inspection technology are identified for replacement under the approved PSEP Decision Tree. As explained in the testimony supporting the approved PSEP, as part of the work previously completed during implementation federal gas transmission pipeline integrity management regulations (49 CFR 192, Subpart O), SoCalGas and SDG&E have already identified, retrofitted and in-line inspected pre-1946 transmission pipelines that were constructed using acceptable welding techniques and are operationally suited to in-line inspection. The remaining pre-1946 segments in the SoCalGas/SDG&E system are not suited for in-line inspection, likely have non-state-of-the-art welds, and would require significant investment for retrofitting to accommodate in-line inspection tools.

Pipeline Enhancement Safety Final Report
Line 85 South Newhall Avenue Replacement Project

Accordingly, consistent with the Commission’s directive in D.11-06-017 to “address retrofitting pipeline to allow for inline inspection tools,” the requirement in California Public Utilities Code section 958 that upon completion of the PSEP, where warranted, pipelines are to be capable of accommodating in-line inspection devices, and the overarching objectives of PSEP to enhance the safety of the pipeline system in a proactive, cost effective manner, the approved PSEP Decision Tree identifies pre-1946 non-piggable pipeline segments for abandonment and/or replacement.

Through this Decision Tree analysis, SoCalGas and SDG&E identified replacement as the more prudent option. Key considerations that support SoCalGas and SDG&E’s determination to replace this segment include:

1. Shut-In Analysis: The Project Team completed a Request for Engineering Review (RER) analysis that concluded the pipeline could not be shut-in.
2. Customer Impacts: The Project Team would require a temporary bypass and a regulator station to maintain customer service.
3. Community Impacts: Minimal traffic impacts and occasional noise.
4. Permit Conditions: The City of Santa Clarita planned to start a Beautification Project in January of 2015 that would place a five year construction moratorium in the city right of way (ROW).
5. Piggability: Non-piggable.
6. Pipe Vintage: 1930.
7. Existing Pipe Attributes: The existing station configuration did not allow for pigging operations due to multiple dead-end connections and diameter changes. The station contained scrubbers that were no longer required for gas quality.

Pipeline Enhancement Safety Final Report
Line 85 South Newhall Avenue Replacement Project

8. Longseam Type: Unknown.
9. Longseam Repair History: No identified issues.
10. Condition of Coating: No identified issues.
11. History of Leaks: No identified issues.

C. Engineering, Design, and Planning Factors

SoCalGas and SDG&E reviewed pipeline drawings and other information, contacted internal planning groups, communicated with external stakeholders, conducted survey activities, including reviewing public records of the area to confirm the presence of underground utilities and substructures, and completed a pre-design site walk. Key factors that influenced the engineering and design of the Project are as follows:

1. Customer Impact: A temporary bypass was required to maintain customer service as noted above. The Project Team planned to utilize a similar design to the then recently completed Supply Line 45-120 Section 1 Replacement Project⁵.
2. Diameter Changes: The Project Team replaced the existing [REDACTED] line with a [REDACTED] line based on the recommendation of the RER and to make the pipeline piggable.
3. Schedule Coordination: The Project Team recognized the benefit of coordinating PSEP replacement work at this station with other pipeline operational enhancement work to improve operability and future maintenance. Additionally, this project was concurrently coordinated with a PSEP Valve Enhancement Project.

⁵ This project was included for Reasonableness Review in the Application 16-09-005 filing.

Pipeline Enhancement Safety Final Report
Line 85 South Newhall Avenue Replacement Project

4. Permit Conditions: The City of Santa Clarita Beautification Project's five year construction moratorium resulted in completion of the Project in two sections. The Project Team accelerated design for the first section of the Project within the city ROW to complete it prior to the start of the moratorium. This work required traffic control plans.
5. Known Substructures: The Project Team utilized potholing data from the Supply Line 45-120 Section 1 Replacement Project to determine the depths required for tie-in to meet the accelerated project schedule.
6. Land Use: The Project Team shared an established laydown yard at Sierra Highway and Newhall Avenue with another PSEP project for the first section of work until a closer laydown yard became available. The Project Team acquired a yard adjacent to the project site for the second section of construction once it became available.

D. Scope Changes

SoCalGas and SDG&E did not make any notable scope changes during detailed design.

Pipeline Enhancement Safety Final Report
Line 85 South Newhall Avenue Replacement Project

III. CONSTRUCTION

A. Construction Contractor Selection

The Project Team prepared an initial cost estimate based on the preliminary design. Following completion of the engineering, design, and planning activities described above, the Project Team directed the Performance Partner to prepare cost estimates based on a more detailed engineering design package. As indicated above, there were no notable changes in scope between the time when the Project Team prepared the preliminary cost estimate and when the Performance Partner prepared and submitted its Target Price Estimate. SoCalGas and SDG&E awarded the construction contract to the Performance Partner.

1. SoCalGas and SDG&E’s Preliminary Construction Cost Estimate (confidential):
SoCalGas and SDG&E’s preliminary estimate for construction was [REDACTED].
2. Construction Contractor’s Target Price Estimate (confidential): The Construction Contractor’s cost estimate was [REDACTED], which was [REDACTED] than SoCalGas and SDG&E’s preliminary cost estimate for construction.

B. Construction Schedule

Table 3: Construction Timeline

Construction Start Date	12/16/2014
Construction Completion Date	12/04/2015
NOP Date	08/19/2015

⁶ This Construction Contractor’s Target Price Estimate include the Newhall Valve Enhancement Project Bundle work is addition to the work related to the Line 85 South Replacement Project.

Pipeline Enhancement Safety Final Report
Line 85 South Newhall Avenue Replacement Project

The Project Team utilized a readily available Performance Partner to meet the accelerated construction timeline for the first section of construction within the city ROW. The Project Team recognized that the original Performance Partner was not the ideal choice for construction within the station and utilized a second Performance Partner for construction of the second section.

C. Changes During Construction

The conditions summarized below were encountered during construction. Activities to address or mitigate these conditions resulted in approximately \$1,500,000 in change orders.

Section 1

1. Constructability Issues: The Project Team encountered unstable ground conditions that resulted in multiple trench cave-ins. This resulted in delays to the construction schedule to remediate the poor soil conditions.
2. Field Design Change: Initial construction plans did not show the location of fittings for the gas handling plan for the isolation and abandonment work. The Project Team completed three additional bell holes to accommodate the fittings and abandonment work.
3. Traffic: The city did not allow for use of K-rails during construction which resulted in safety concerns. The Project Team worked with the Sheriff's Department to set up a Construction Zone Enhanced Enforcement Program (COZEEP) operation to control the flow of traffic to maintain a safe working environment.

Pipeline Enhancement Safety Final Report
Line 85 South Newhall Avenue Replacement Project

4. Permit Conditions: The Project Team estimated the construction duration based on a 10 hour day seven days a week work schedule based on initial meetings with the city. The city later requested that the Project Team work an eight hour day five days a week construction schedule, resulting in additional crews needed to meet the Project schedule and moratorium deadline.
5. Schedule Delay: The shared laydown yard was demobilized due to conflicts with the Storm Water Pollution Prevention Plan (SWPPP) after the completion of the other project utilizing the yard. The Project Team halted construction in order to mobilize and establish the new laydown yard.
6. Tie-In: The Project Team planned for a 12 hour tie-in window that did not include the sandblasting and coating of the tie-in. In order to reopen the road, the Project Team completed this immediately following the tie-in. This resulted in extended hours to complete this activity.

Section 2

1. Constructability Issues:
 - a. The Construction Contractor encountered an unknown pipeline resulting in approximately 16 days of standby during abatement activities.
 - b. The Project Team needed to replace additional pipe on Line 408 to accommodate the final tie-in due to poor pipe condition.
2. Design Changes:
 - a. SoCalGas and SDG&E requested two additional hydrotests to test all segments to include testing of all pipe diameters found at this location to their highest potential.

Pipeline Enhancement Safety Final Report
Line 85 South Newhall Avenue Replacement Project

- b. The Project Team provided additional support for the valve automation contractor and final tie-in work.
- c. The Project Team revised the design from installing a single 50 foot run of [REDACTED] [REDACTED] to a dual run of [REDACTED] and [REDACTED] to five new valves for pressure control and valve actuation.

Pipeline Enhancement Safety Final Report
Line 85 South Newhall Avenue Replacement Project

Figure 5: Existing Obsolete Equipment



Pipeline Enhancement Safety Final Report
Line 85 South Newhall Avenue Replacement Project

Figure 6: Shoring During Construction within Station



Pipeline Enhancement Safety Final Report
Line 85 South Newhall Avenue Replacement Project

Figure 7: Construction within the Station



Pipeline Enhancement Safety Final Report
Line 85 South Newhall Avenue Replacement Project

Figure 8: Station after Construction



Pipeline Enhancement Safety Final Report
Line 85 South Newhall Avenue Replacement Project

D. Commissioning and Site Restoration

Commissioning activities include restoration of the site, final inspection and placement of the pipeline back into service, transportation and disposal of hydrotested water and hazardous material, and site demobilization. Closeout activities include development of final drawings, finalization of a reconciliation package, and updates to company recordkeeping systems to reflect the completed scope of work.

Pipeline Enhancement Safety Final Report
Line 85 South Newhall Avenue Replacement Project

IV. PROJECT COSTS

A. Cost Avoidance Actions

SoCalGas and SDG&E exercised due diligence in the planning, design, and construction activities for this project to minimize or avoid costs when prudent to do so. As discussed above, the Project Team conducted a site visit to identify and incorporate discernible site conditions into the engineering, design, and planning of the Project. Specific examples of cost avoidance actions taken on this project are:

1. Materials:
 - a. Bulk ordered pipe provided volume pricing for the [REDACTED] pipe.
 - b. The Project Team utilized a prefabricated temporary regulator station from the Operating District.
2. Planning and Coordination:
 - a. The Project Team utilized pothole results from a previous project to verify existing site conditions.
 - b. The Project Team coordinated design and construction with two additional projects within the station.
3. Land Use: The Project Team shared a laydown for the first section to initiate construction as soon as practicable and then transferred to a more proximate laydown yard for the second section.

Pipeline Enhancement Safety Final Report
Line 85 South Newhall Avenue Replacement Project

B. Cost Estimate

Based on the preliminary design, once the project scope was confirmed and engineering, design, and planning activities were underway, SoCalGas and SDG&E prepared an estimate of the Direct Costs of the Project in the amount of \$7,452,267. This estimate was prepared in December of 2014 and June of 2015, using the “SCG Pipeline Estimate Template Rev 2” estimating tool, the most current version of the PSEP Estimate Template at the time. The Project Team considered the conditions known at the time to prepare the preliminary Direct Cost estimate. This estimate reflects the projected Labor, Material, and Services costs anticipated to be incurred to execute the Project.

SoCalGas and SDG&E estimated Indirect Costs of the Project based on the estimated Direct Costs and other project-related variables.

C. Actual Direct and Indirect Costs

Actual Direct Costs reflect the Labor, Material, and Service costs incurred to execute the Project. Actual Indirect Costs reflect costs for incremental overhead loaders in accordance with Company overhead allocation policies. The total loaded cost of the Project is \$9,879,832.

Pipeline Enhancement Safety Final Report
Line 85 South Newhall Avenue Replacement Project

Table 4: Estimated and Actual Direct Costs and Variances

Direct Costs (\$)	Estimate	Actuals	Delta Over/(Under)
Company Labor	387,944	697,422	309,478
Materials	1,059,590	508,405	(551,185)
Construction Contractor	3,077,132	4,452,381	1,375,249
Construction Management & Support	454,083	999,352	545,269
Environmental	235,749	403,521	167,772
Engineering & Design	918,989	575,981	(343,008)
Project Management & Services	451,392	244,280	(207,112)
ROW & Permits	79,750	2,065	(77,685)
GMA	787,638	1,025,381	237,743
Total Direct Costs	7,452,267	8,908,788	1,456,521

Table 5: Estimated and Actual Indirect Costs, Total Costs, and Variances

Indirect Costs/Total Costs (\$)	Estimate	Actuals	Delta Over/(Under)
Overheads	1,001,543	946,183	(55,360)
AFUDC	559,231	19,206	(540,025)
Property Taxes	117,388	5,655	(111,733)
Total Indirect Costs	1,678,162	971,044	(707,118)
Total Direct Costs	7,452,267	8,908,788	1,456,521
Total Loaded Costs	9,130,429	9,879,832	749,403

D. Disallowance

There was no disallowance for Line 85 South Newhall Avenue as there were no post-1955 segments included in the Project without records that provide the minimum information to demonstrate compliance with then applicable industry standards or regulatory strength testing and recordkeeping requirements.

Pipeline Enhancement Safety Final Report
Line 85 South Newhall Avenue Replacement Project

V. CONCLUSION

SoCalGas and SDG&E enhanced the safety of their integrated natural gas transmission system by prudently executing the Line 85 South Newhall Avenue Replacement Project. Through this Replacement Project, SoCalGas and SDG&E successfully replaced 0.174 miles of station piping in the City of Newhall and enhanced the piggability of the pipeline. The total loaded cost of the Project is \$9,879,832.

SoCalGas and SDG&E executed this project prudently by executing the Project in an accelerated manner to complete the necessary construction prior to the start of the City of Santa Clarita moratorium, enhancing the piggability of the pipelines and station. The Project Team also removed obsolete equipment within the station reducing long term maintenance costs of the station.

SoCalGas and SDG&E engaged in prudent cost avoidance efforts by utilizing bulk ordered material, coordinated with other projects nearby and within the station, and utilized recently completed pothole data.

End of Line 85 South Newhall Avenue Replacement Project Final Report

Pipeline Safety Enhancement Plan Final Report
Line 2000-West Santa Fe Springs Station Replacement Project

I. LINE 2000-WEST SANTA FE SPRINGS STATION REPLACEMENT PROJECT

A. Background and Summary

Line 2000 is a predominantly [REDACTED] diameter transmission line that runs approximately 225 miles from the California/Arizona border in Blythe to the Los Angeles Basin. The pipeline is primarily routed across a Class 1 location. This report describes the activities associated with the Line 2000-West Santa Fe Springs Station Replacement Project that consists of a 0.2 mile replacement, the removal of seven scrubbers, the installation of a new filter separator and bypass in place, and the removal and replacement of a preexisting header and bridle system. The specific attributes of this Project are detailed in Table 1 below. The total loaded cost of the Project is \$9,416,150.

SoCalGas and SDG&E separated the Line-2000 Project into four separate projects: Line 2000-A¹, Line 2000-B, Line 2000-C², and Line 2000-West for project manageability purposes and due to unique characteristics related to non-contiguous portions of the pipeline. Subsequently, the Line 2000-West Santa Fe Springs Station Replacement Project was separated from the Line 2000-West Hydrotest Project.

¹ Line 2000-A Hydrotest Project was submitted for reasonableness review in A.14-12-016 and was approved in D.16-12-063.

² Line 2000-C Hydrotest Project is included in this filing for reasonableness review. See workpapers.

Pipeline Safety Enhancement Plan Final Report
Line 2000-West Santa Fe Springs Station Replacement Project

Table 1: General Project Information

Project Name	Line 2000-West Santa Fe Springs Station		
Project Type	Replacement		
Length	0.200 miles		
Location	Santa Fe Springs, Pico Rivera		
Class	3		
MAOP (<i>confidential</i>)	[REDACTED]		
Pipe Vintage	1947		
Construction Start	10/24/2016		
Construction Finish	04/05/2017		
Original Pipe Diameter (<i>confidential</i>)	[REDACTED]		
New Diameter (<i>confidential</i>)	[REDACTED]		
Original SMYS ³ (<i>confidential</i>)	[REDACTED]		
New SMYS (<i>confidential</i>)	[REDACTED]		
Project Costs (\$)	Capital	O&M	Total
Loaded Project Costs	9,416,150	-	9,416,150
Disallowed Costs	<u>3,191-</u>	-	<u>3,191-</u>

³ Highest percentage of Specified Minimum Yield Strength (SMYS) of Category 4 Criteria pipe.

Pipeline Safety Enhancement Plan Final Report
Line 2000-West Santa Fe Springs Station Replacement Project

B. Maps and Images

Figure 1: Satellite Image of Line 2000-West Santa Fe Springs Station Replacement Project

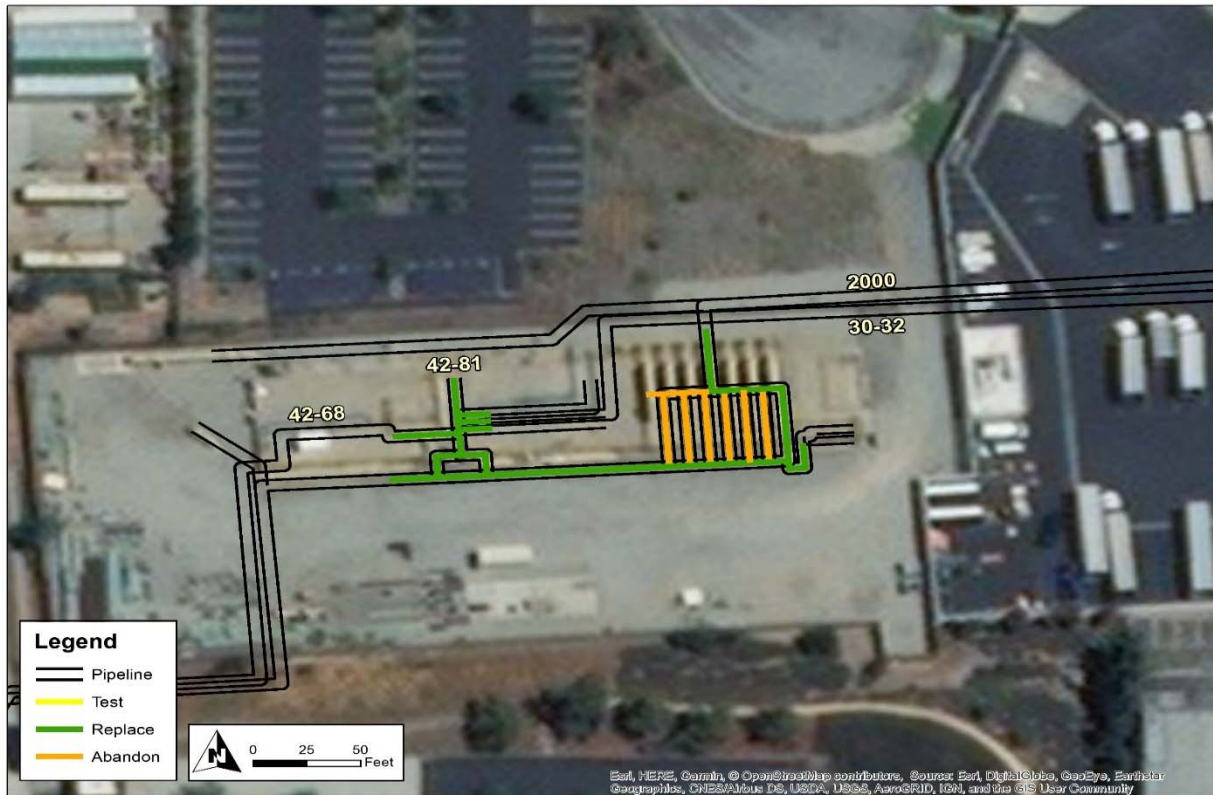

Pipeline Safety Enhancement Plan Final Report
Line 2000-West Santa Fe Springs Station Replacement Project

Figure 2: Overview Map of Line 2000-West Santa Fe Springs Station Replacement Project

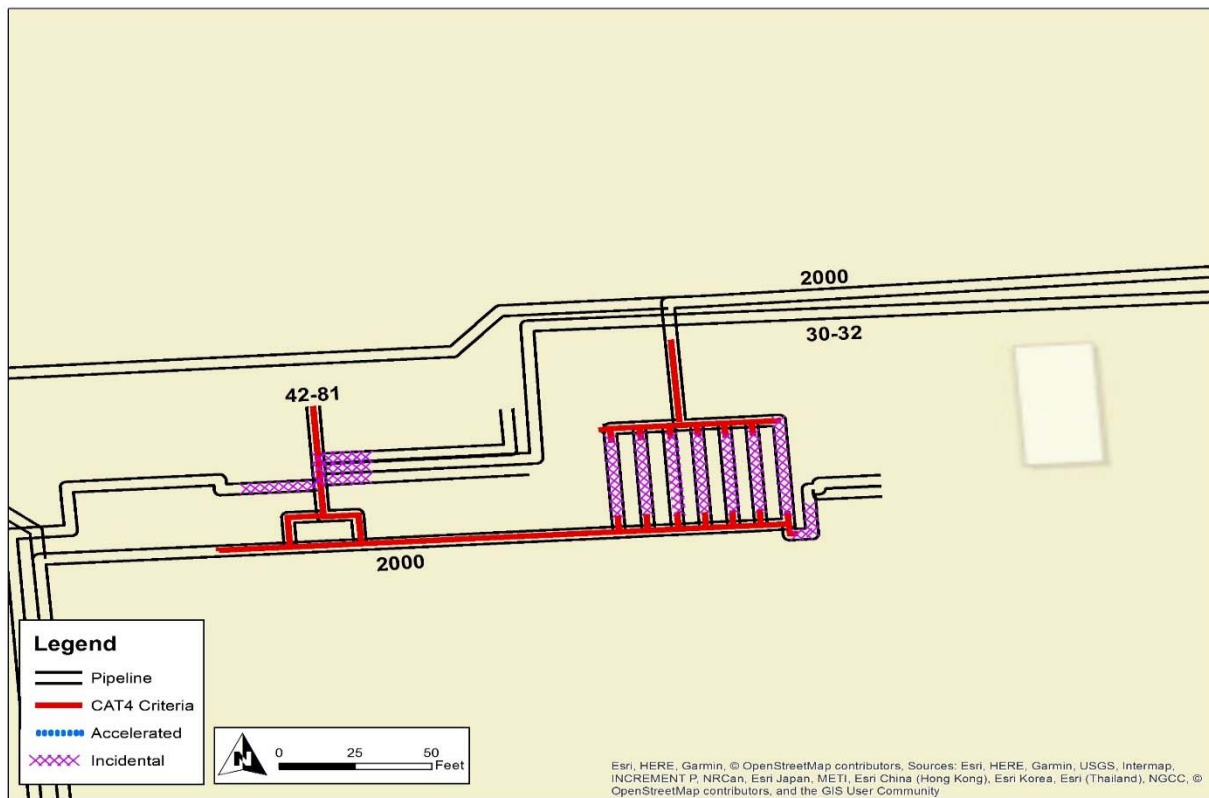

Pipeline Safety Enhancement Plan Final Report Line 2000-West Santa Fe Springs Station Replacement Project

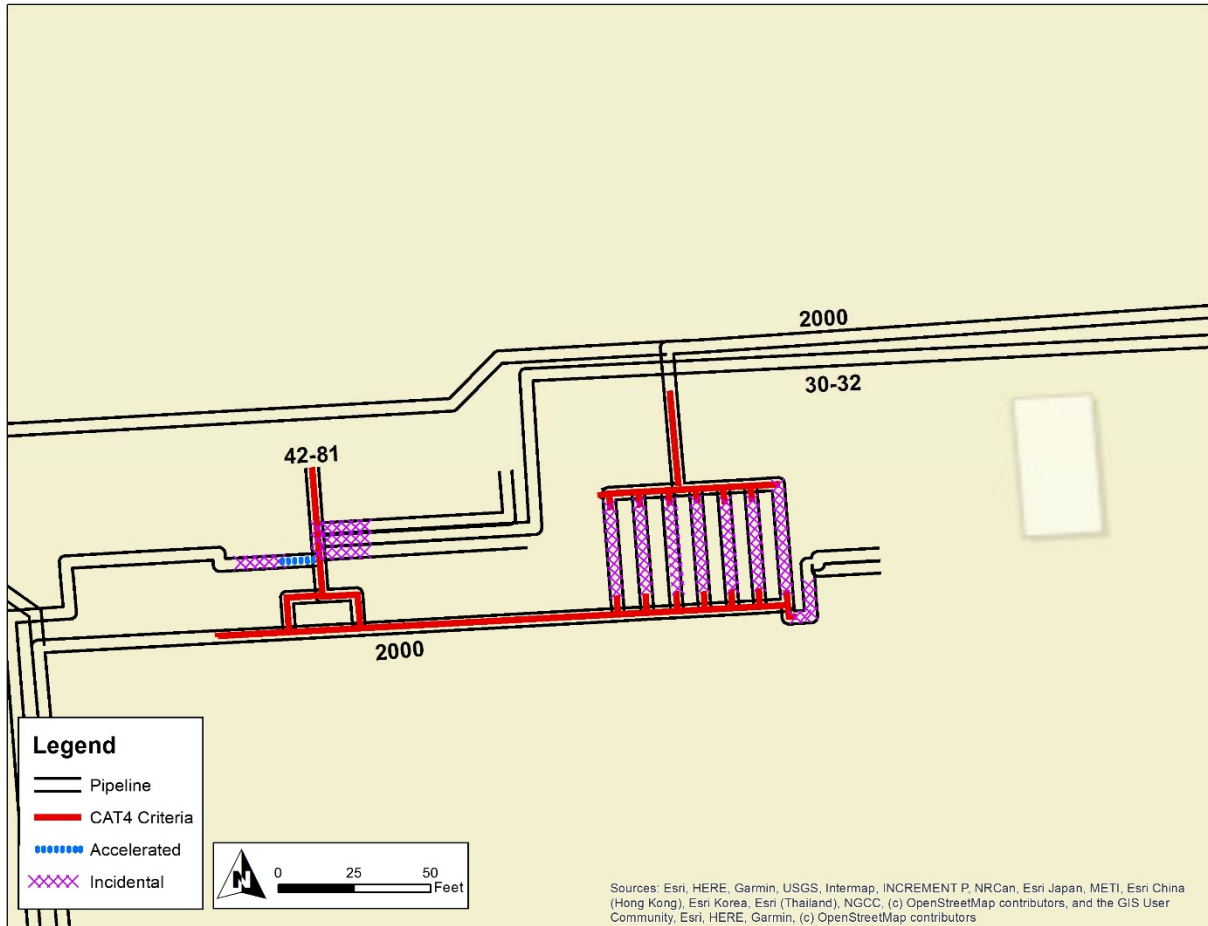

Pipeline Safety Enhancement Plan Final Report
Line 2000-West Santa Fe Springs Station Replacement Project

II. ENGINEERING, DESIGN, AND PLANNING

A. Project Scope

Table 2: Mileage Information

	Criteria	Accelerated ⁴	Incidental	New	Total ⁵
Final Mileage	0.057 mi.	0.0020 mi.	0.070 2 mi.	0.070 mi.	0.200 mi.
	303 ft.	80 ft.	37 19 ft.	372 ft.	1,054 ft.

SoCalGas and SDG&E presented a conceptual project scope in workpapers supporting the 2011 PSEP filing.⁶ Prior to initiating execution of the Project in 2016, SoCalGas and SDG&E reviewed existing pipeline records to validate the scope of the Project. During the Engineering, Design, and Planning phase, SoCalGas and SDG&E further refined the scope. The progression of project scope is summarized as follows:

1. 2011 PSEP Filing: SoCalGas and SDG&E identified Line 2000 as a Phase 1A Hydrotest Project comprised of 55.027 miles of Category 4 Criteria pipe and 62.574 miles of Accelerated pipe.
2. Scope Validation: Through scope validation activities, after the 2011 filing and before initiating execution of the Project, SoCalGas and SDG&E successfully reduced the scope of the Project by 54.957 miles of Category 4 Criteria pipe.

⁴ Accelerated mileage includes Phase 2A pipe. Phase 2A includes pipelines without sufficient record of a pressure test in less populated areas. The Accelerated mileage was included to realize efficiencies and to enhance project constructability.

⁵ Values may not add to total due to rounding.

⁶ See Amended PSEP of SoCalGas and SDG&E, submitted December 2, 2011, in R.11-02-019 and subsequently transferred to A.11-11-002.

Pipeline Safety Enhancement Plan Final Report
Line 2000-West Santa Fe Springs Station Replacement Project

3. Engineering, Design, and Constructability:

- a. This project was originally part of the Line 2000-West Hydrotest Project scope and included 511.4 feet of Category 4 Criteria pipe that connects to a gas filtration scrubber system within Santa Fe Springs Station. Due to the complexity of the design and lead time required for materials, this portion of the Project was rescope as a separate project from the Line 2000-West Hydrotest Project to initiate hydrotests as soon as practicable.
- b. Due to the vintage, dated technology, and engineering recommendation, it was determined to replace the seven scrubbers with one filter separator.

4. Final Project Scope: The final project scope consists of a 0.200 mile replacement that consisted of the removal of seven scrubbers, the installation of a new filter separator and bypass in place, and the removal and replacement of a preexisting header and bridle system. There was ~~no~~ 8 feet of Accelerated Phase 2A mileage and ~~37~~19-feet of Incidental pipe.

B. Decision Tree Analysis

SoCalGas and SDG&E performed a PSEP Decision Tree analysis of Line 2000-West in its entirety and confirmed the project design should commence as a Hydrotest Project. A subsequent Decision Tree analysis of the inlet and outlet piping only confirmed that the project design for this rescope portion of the Project should commence as a replacement project.

Pipeline Safety Enhancement Plan Final Report
Line 2000-West Santa Fe Springs Station Replacement Project

Segments of less than 1,000 feet are identified for replacement under the approved PSEP Decision Tree because, for short segments of pipe, the logistical costs associated with pressure testing (for example, permitting, construction, water handling, and service disruptions for a non-looped system) can approach or exceed the cost of replacement. In such circumstances, replacement affords a more cost-effective approach to achieving compliance with D.11-06-017 while providing equal safety enhancement benefits. Moreover, installation of the new segment can usually be performed while the existing service is maintained to customers, thereby avoiding service disruptions that may otherwise occur during pressure testing.

Through this Decision Tree analysis, SoCalGas and SDG&E identified replacement as the more prudent option. Key considerations that supported SoCalGas and SDG&E's determination to replace this segment include:

1. Identified Risks: Hydrotesting the station piping with the seven scrubbers as one test was not practicable, and isolation to conduct several tests would have been required. Hydrotesting was not feasible due to the following challenges:
 - a. Ability to test the inlet and outlet piping without voiding the vessel's pressure rating.
 - b. Clearing the vessels for hot work would be complex and require emission controls and disposal of hazardous waste liquids and sludge.
 - c. Nozzle stub lengths out of the vessels were not long enough to cut and reweld inlet and outlet piping following hydrotest. Any modifications to the vessel would void manufacturer's ASME pressure certifications.
2. Piggability: Non-piggable.
3. Pipe Vintage: 1947.

Pipeline Safety Enhancement Plan Final Report
Line 2000-West Santa Fe Springs Station Replacement Project

C. Engineering, Design, and Planning Factors

SoCalGas and SDG&E reviewed pipeline drawings and other information, contacted internal planning groups, communicated with external stakeholders, conducted survey activities, including reviewing public records, and ground penetrating radar (GPR) of the area to confirm the presence of underground utilities and substructures, and completed a pre-design site walk. Key factors that influenced the engineering and design of the Project are as follows:

1. Shut-In Analysis: As discussed above, Project Team completed a Request for Engineering Review (RER) analysis and concluded a throughput bypass was required to bypass the station and maintain system function.
2. Customer Impacts: The Project Team phased the bypass installation to minimize customer outages to 24 hours or less and worked with each customer to arrange an acceptable time to cut their service, some tie-ins were on weekends or overnight.
3. Land Use: In depth planning and coordination with the Operating District avoided the need for additional laydown and work space.
4. Known Substructures: The majority of the piping is above ground. GPR was utilized to confirm rebar and determine the capacity of the existing foundations, while concrete core samples were taken to determine the thickness. The existing foundation was used when possible based on the results of the GPR and concrete core samples.

Pipeline Safety Enhancement Plan Final Report
Line 2000-West Santa Fe Springs Station Replacement Project

5. Environmental:

- a. The scrubbers had been in operation since the 1940s, resulting in a contaminated sludge built up in the vessels, that included the anticipation of polychlorinated biphenyls (PCBs).
- b. Lead paint was assumed on all above ground piping, scrubbers, and cut points.
- c. Several demolition methods were developed to minimize environmental risks.

6. Valves:

- a. 12 valves were replaced for this project:
 - i. The preexisting [REDACTED] plug valve, mainline valve (MLV), at the station was replaced with a [REDACTED] ball valve.
 - ii. The 10 valves on the preexisting header and bridle system were replaced. In order to mitigate the header's Category 4 Criteria pipe without extensive customer impacts, it was more feasible to prefabricate and test a new replacement header, bridle, and associated taps, and install the new connections in a one day isolation.
 - iii. A tap valve for a supply line connection was relocated and replaced as the original connection was tied directly to the scrubbers that were removed. The relocation also allowed for more efficient maintenance operations as the original configuration did not allow for any redundancies.
- b. Three new [REDACTED] ball valves were installed for the purpose of the filter separator maintenance bypass.

Pipeline Safety Enhancement Plan Final Report
Line 2000-West Santa Fe Springs Station Replacement Project

Figure 3: Line 2000-West Santa Fe Springs Station Replacement Project Schematic – Before

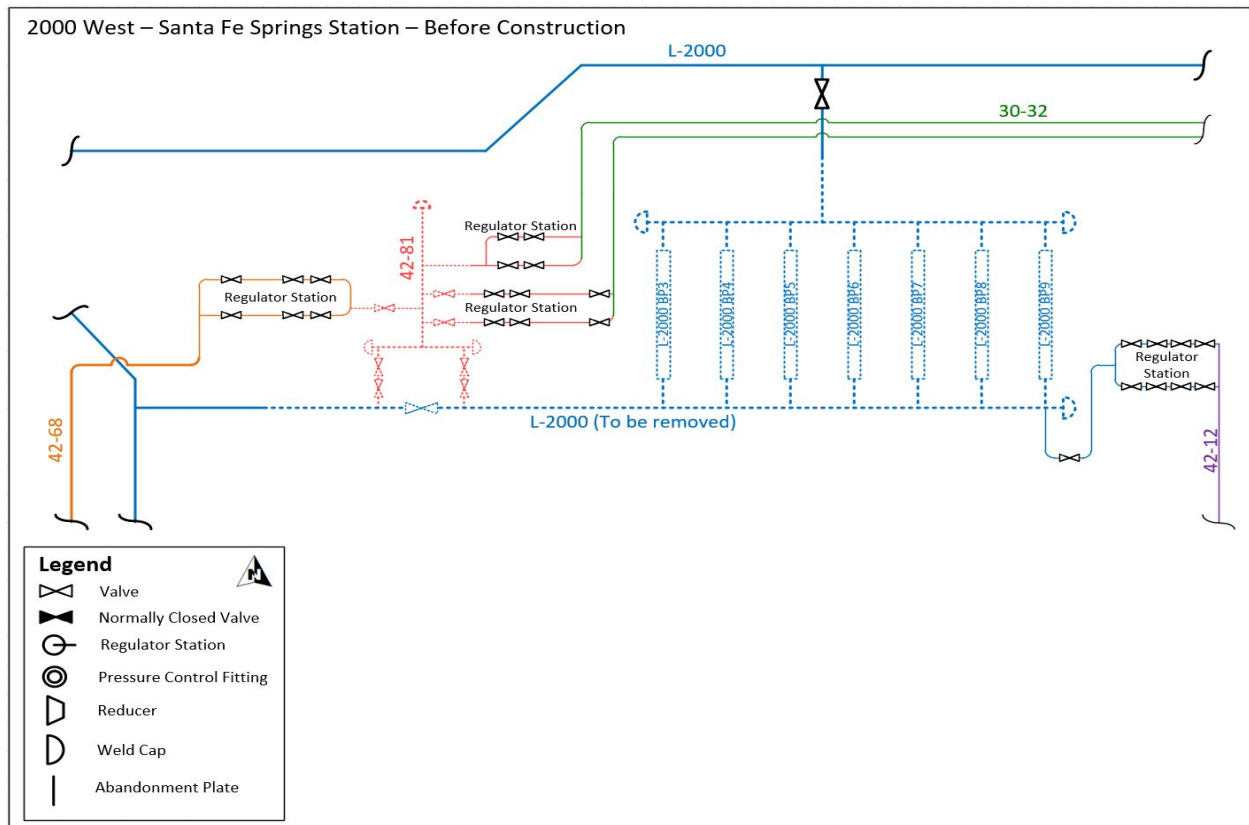

Pipeline Safety Enhancement Plan Final Report Line 2000-West Santa Fe Springs Station Replacement Project

Figure 4: Line 2000-West Santa Fe Springs Station Replacement Project Schematic – After

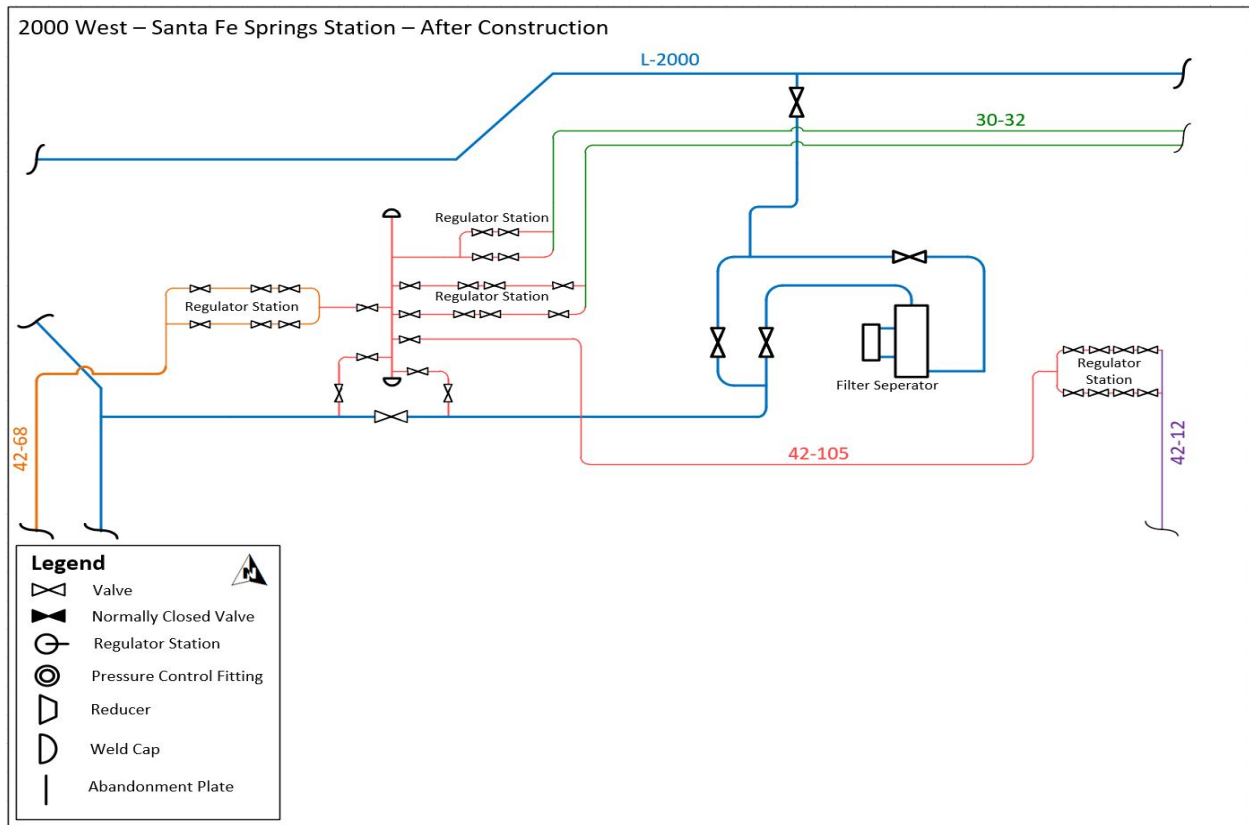

Pipeline Safety Enhancement Plan Final Report
Line 2000-West Santa Fe Springs Station Replacement Project

D. Scope Changes

SoCalGas and SDG&E did not make any notable scope changes during detailed design.

Pipeline Safety Enhancement Plan Final Report
Line 2000-West Santa Fe Springs Station Replacement Project

III. CONSTRUCTION

A. Construction Contractor Selection

The Project Team prepared an initial cost estimate based on the preliminary design. Following completion of the engineering, design, and planning activities described above, SoCalGas and SDG&E entered into a competitive bidding process to select a construction contractor, that included the updated design described in the discussion of notable Scope Changes above. SoCalGas and SDG&E awarded the construction contract to the bidder that best met the selection criteria for this project.

1. SoCalGas and SDG&E's Preliminary Construction Cost Estimate (*confidential*): SoCalGas and SDG&E's preliminary cost estimate for construction was [REDACTED].
2. Construction Contractor's Bid (*confidential*): The Construction Contractor's bid was [REDACTED], that was [REDACTED] than SoCalGas and SDG&E's preliminary cost estimate for construction.

B. Construction Schedule

Table 3: Construction Timeline

Construction Start Date	10/24/2016
Construction Completion Date	04/05/2017
NOP Date	02/24/2017

C. Changes During Construction

SoCalGas and SDG&E successfully mitigated conditions during construction in a manner that minimized potential impacts on project scope, cost, and schedule. As a result, these conditions did not result in any notable change orders.

Pipeline Safety Enhancement Plan Final Report
Line 2000-West Santa Fe Springs Station Replacement Project

Figure 5: One (of Seven) Scrubber Assemblies Being Removed



Pipeline Safety Enhancement Plan Final Report
Line 2000-West Santa Fe Springs Station Replacement Project

Figure 6: Line 2000 to Line 42-105 Connector



Pipeline Safety Enhancement Plan Final Report
Line 2000-West Santa Fe Springs Station Replacement Project

Figure 7: Crane Lowering New Filter Separator into Place

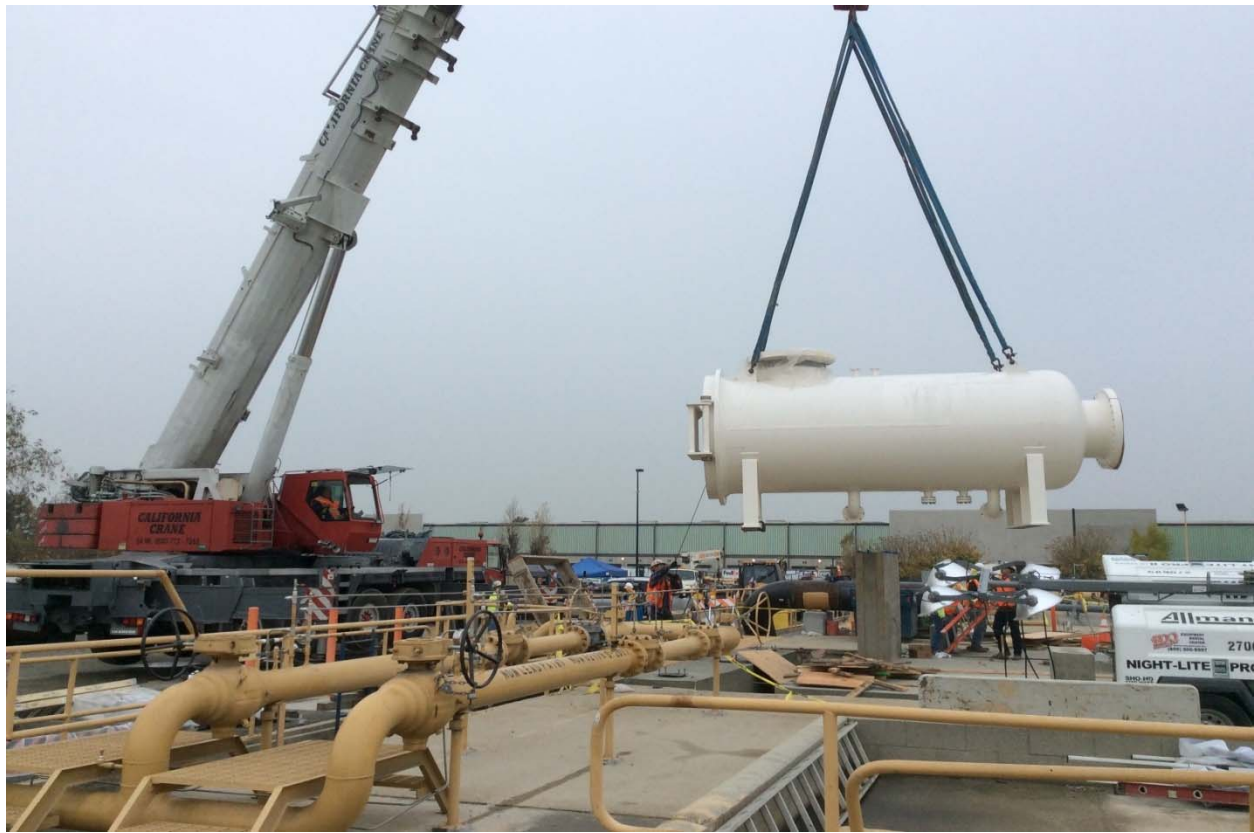

Pipeline Safety Enhancement Plan Final Report
Line 2000-West Santa Fe Springs Station Replacement Project

Figure 8: New Filter Separator Vessels



Pipeline Safety Enhancement Plan Final Report
Line 2000-West Santa Fe Springs Station Replacement Project

Figure 9: New Filter Separator



Pipeline Safety Enhancement Plan Final Report
Line 2000-West Santa Fe Springs Station Replacement Project

D. Commissioning and Site Restoration

Commissioning activities include restoration of the site, final inspection and placement of the pipeline back into service, transportation and disposal of hydrotested water and hazardous material, and site demobilization. Closeout activities include development of final drawings, finalization of a reconciliation package, and updates to company recordkeeping systems to reflect the completed scope of work.

Pipeline Safety Enhancement Plan Final Report
Line 2000-West Santa Fe Springs Station Replacement Project

IV. PROJECT COSTS

A. Cost Avoidance Actions

SoCalGas and SDG&E exercised due diligence in the planning, design, and construction activities for this project to minimize or avoid costs when prudent to do so. As discussed above, the Project Team conducted a site visit to identify and incorporate discernible site conditions into the engineering, design, and planning of the Project. Specific examples of cost avoidance actions taken on this project are:

1. Planning and Coordination:
 - a. In depth planning and coordination during planning, design, and constructability review with the Operating District and a nearby private business avoided the need for an additional laydown yard and work space.
 - b. Prior to construction, the Project Team planned the demolition and installation to be done in phases that would mitigate and minimize any customer impacts. By phasing the work, the Project Team avoided needing temporary feeds to customers and the cost of compressed natural gas (CNG) / liquified natural gas (LNG) or bypass work.
2. Future Maintenance: The relocation of a supply line connection allowed for more efficient maintenance and operations, as the original configuration did not allow for bypass configuration.

Pipeline Safety Enhancement Plan Final Report
Line 2000-West Santa Fe Springs Station Replacement Project

B. Cost Estimate

Based on the preliminary design, once the project scope was confirmed and engineering, design, and planning activities were underway, SoCalGas and SDG&E prepared an estimate of the Direct Costs of the Project in the amount of \$11,797,720. This estimate was prepared in October of 2016, using the “SCG Pipeline Estimate Template Rev 3” estimating tool, the most current version of the PSEP Estimate Template at the time. The Project Team considered the conditions known at the time to prepare the preliminary Direct Cost estimate. This estimate reflects the projected Labor, Material, and Services costs anticipated to be incurred to execute the Project.

SoCalGas and SDG&E estimated Indirect Costs of the Project based on the estimated Direct Costs and other project-related variables.

C. Actual Direct and Indirect Costs

Actual Direct Costs reflect the Labor, Material, and Service costs incurred to execute the Project. Actual Indirect Costs reflect costs for incremental overhead loaders in accordance with Company overhead allocation policies. The total loaded cost of the Project is \$9,416,150.

Pipeline Safety Enhancement Plan Final Report
Line 2000-West Santa Fe Springs Station Replacement Project

Table 4: Estimated and Actual Direct Costs and Variances

Direct Costs (\$)	Estimate	Actuals	Delta Over/(Under)
Company Labor	451,170	419,055	(32,115)
Materials	1,925,367	1,466,238	(459,129)
Construction Contractor	5,047,103	2,670,014	(2,377,089)
Construction Management & Support	614,060	515,926	(98,134)
Environmental	87,450	204,281	116,831
Engineering & Design	1,447,735	1,804,463	356,728
Project Management & Services	1,152,315	337,059	(815,256)
ROW & Permits	-	2,848	2,848
GMA	1,072,520	918,484	(154,036)
Total Direct Costs	11,797,720	8,338,368	(3,459,352)

Table 5: Estimated and Actual Indirect Costs, Total Costs, and Variances

Indirect Costs/Total Costs (\$)	Estimate	Actuals	Delta Over/(Under)
Overheads	738,027	802,834	64,807
AFUDC	661,318	240,167	(421,151)
Property Taxes	157,093	34,781	(122,312)
Total Indirect Costs	1,556,438	1,077,782	(478,656)
Total Direct Costs	11,797,720	8,338,368	(3,459,352)
Total Loaded Costs	13,354,158	9,416,150	(3,938,008)

D. Disallowance

~~There was no disallowance for Supply Line 2000 West Santa Fe Springs Station as there were no post-1955 segments included in the Project without records that provide the minimum information to demonstrate compliance with then-applicable industry standards or regulatory strength testing and recordkeeping requirements. For this replacement project, SoCalGas and SDG&E identified 8 feet of pipe installed after 1955 and lacking records that provide the minimum information necessary to demonstrate compliance with then-applicable industry standards or regulatory strength testing and~~

Pipeline Safety Enhancement Plan Final Report Line 2000-West Santa Fe Springs Station Replacement Project

recordkeeping requirements. Of the pipeline that was replaced 8 feet of Phase 2A pipe are disallowed. Therefore, a \$3,191 reduction to ratebase was calculated by multiplying 8 feet of pipe by \$2,105,878 per mile, which was SoCalGas and SDG&E's system average cost of pressure testing at the time the pipeline was returned to service.

Pipeline Safety Enhancement Plan Final Report
Line 2000-West Santa Fe Springs Station Replacement Project

V. CONCLUSION

SoCalGas and SDG&E enhanced the safety of their integrated natural gas transmission system by prudently executing the Line 2000-West Santa Fe Springs Station Replacement Project. Through this Replacement Project, SoCalGas and SDG&E successfully replaced 0.200 miles of pipe, removed seven scrubbers, installed a new filter separator and bypass in its place, removed of a preexisting header and bridle system in the City of Santa Fe Springs. The total loaded cost of the Project is \$9,416,150.

SoCalGas and SDG&E executed this project prudently by engaging in scope validation efforts that reduced project mileage, early and detailed risk identification and mitigation, and responded to unanticipated field conditions.

SoCalGas and SDG&E engaged in prudent cost avoidance efforts by developing and executing a more efficient design to complete the safety enhancement work as soon as practicable.

End of Line 2000-West Santa Fe Springs Station Replacement Project Final Report

Pipeline Safety Enhancement Plan Final Report
Supply Line 31-09 Hydrotest Project

I. SUPPLY LINE 31-09 HYDROTEST PROJECT

A. Background and Summary

Supply Line 31-09 is a [REDACTED] diameter supply line that runs approximately 14.7 miles from SoCalGas Brea Canyon Station in the City of Diamond Bar and terminates into Supply Line 31-22 at the intersection of Palomares Avenue and South San Dimas Canyon Road in the City of San Dimas. This project begins near the major intersection of Brea Canyon Road and Old Ranch Road, congested with multiple overhead and underground utilities (see Figures 1 and 2), and is located within a heavily industrialized, densely populated area in the City of Industry. The pipeline is routed across a Class 3 location. This report describes the activities associated with the Supply Line 31-09 Hydrotest Project that consists of the hydrotest of 0.212 miles of pipeline. The specific attributes for this Project are detailed in Table 1 below. The total loaded cost of the Project is \$3,651,114.

Pipeline Safety Enhancement Plan Final Report
Supply Line 31-09 Hydrotest Project

Table 1: General Project Information

Project Name	Supply Line 31-09		
Project Type	Hydrotest		
Length	0.212 miles		
Location	City of Industry		
Class	3		
MAOP (<i>confidential</i>)	[REDACTED]		
Pipe Vintage	1969		
Construction Start	07/20/2015		
Construction Finish	10/13/2015		
Original Pipe Diameter (<i>confidential</i>)	[REDACTED]		
New Diameter (<i>confidential</i>)	N/A		
Original SMYS ¹ (<i>confidential</i>)	[REDACTED]		
New SMYS (<i>confidential</i>)	[REDACTED]		
Project Costs (\$)	Capital	O&M	Total
Loaded Project Costs	-	3,651,114	3,651,114
Disallowed Costs	-	820,900	820,900

¹ Highest percentage of Specified Minimum Yield Strength (SMYS) of Category 4 Criteria pipe.

Pipeline Safety Enhancement Plan Final Report
Supply Line 31-09 Hydrotest Project

B. Maps and Images

Figure 1: Satellite Image of Supply Line 31-09 Hydrotest Project

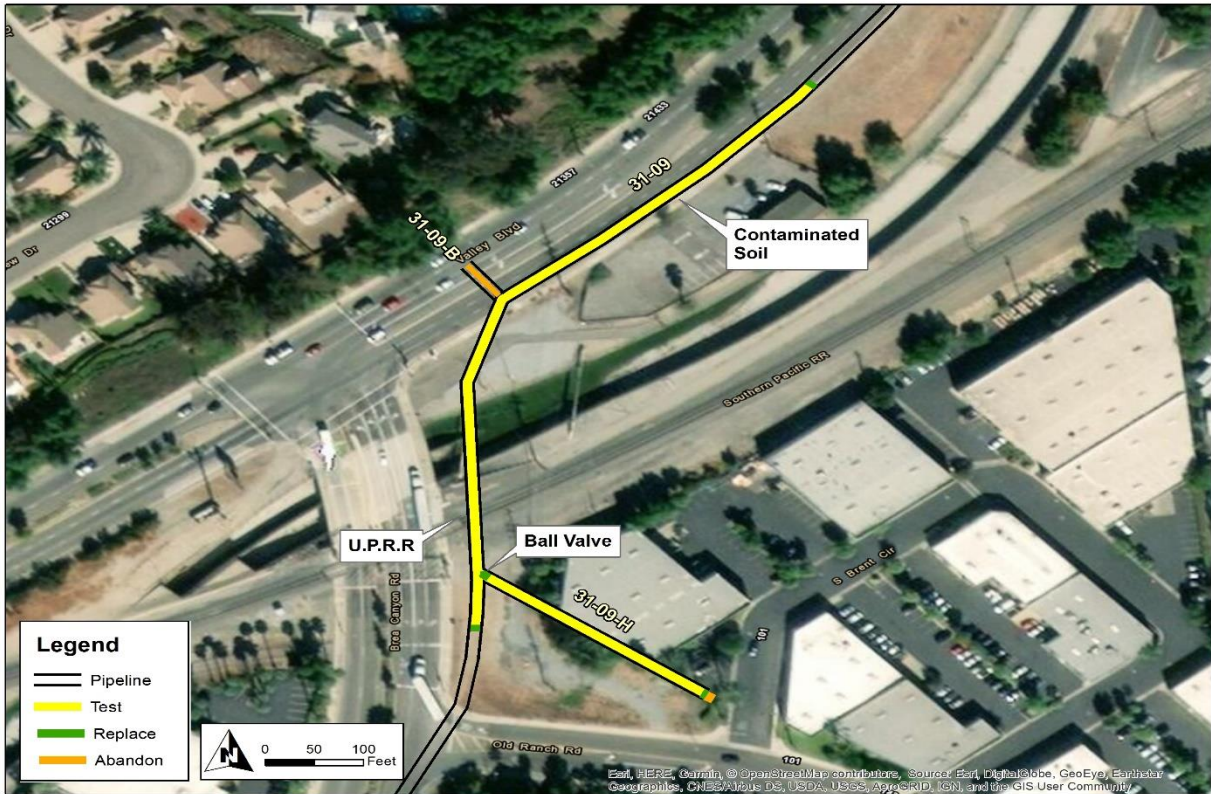

Pipeline Safety Enhancement Plan Final Report Supply Line 31-09 Hydrotest Project

Figure 2: Overview Map of Supply Line 31-09 Hydrotest Project

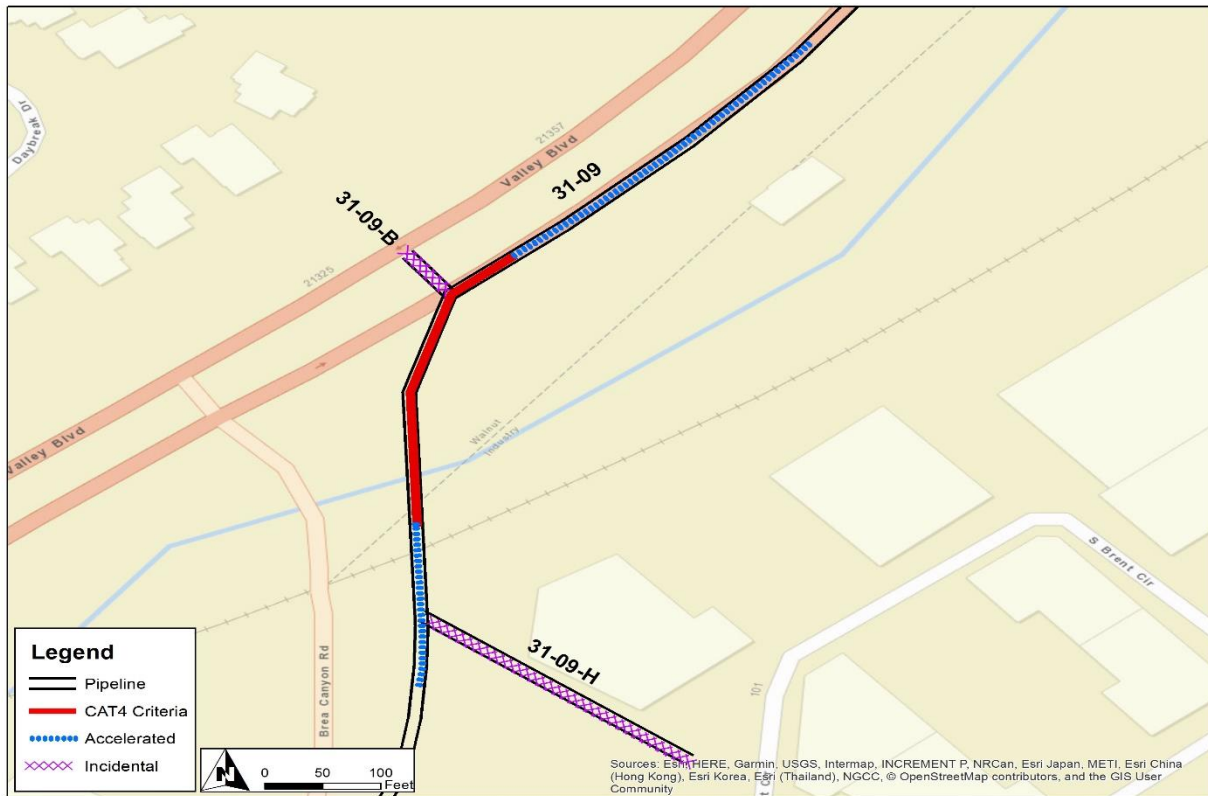

Pipeline Safety Enhancement Plan Final Report
Supply Line 31-09 Hydrotest Project

II. ENGINEERING, DESIGN, AND PLANNING

A. Project Scope

Table 2: Mileage Information

	Criteria	Accelerated ²	Incidental	Total ³
Final Mileage	0.045 mi.	0.111 mi.	0.055 mi.	0.212 mi.
	239 ft.	588 ft.	293 ft.	1,120 ft.

SoCalGas and SDG&E presented a conceptual project scope in workpapers supporting the 2011 PSEP filing.⁴ Prior to initiating execution of the Project in 2015, SoCalGas and SDG&E reviewed existing pipeline records to validate the scope of the Project. During the Engineering, Design, and Planning phase, SoCalGas and SDG&E further refined the scope. This progression of the project scope is summarized as follows:

1. 2011 PSEP Filing: SoCalGas and SDG&E initially identified Supply Line 31-09 as a Phase 1A Replacement Project comprised of 7.348 miles of Category 4 Criteria pipe and 5.462 miles of Accelerated pipe.
2. Scope Validation: Through scope validation activities, after the 2011 filing and before initiating execution of the Project, SoCalGas and SDG&E successfully reduced the scope of the Project by 7.303 miles of Category 4 Criteria pipe.

² Accelerated mileage includes Phase 2B pipe. Phase 2B includes pipelines without record of a pressure test to modern – Subpart J – standards (Phase 2B). The Accelerated mileage was included to realize efficiencies and to enhance project constructability.

³ Values may not add to total due to rounding.

⁴ See Amended PSEP of SoCalGas and SDG&E, submitted December 2, 2011, in R.11-02-019 and subsequently transferred to A.11-11-002.

Pipeline Safety Enhancement Plan Final Report
Supply Line 31-09 Hydrotest Project

3. Engineering, Design, and Constructability:
 - a. SoCalGas and SDG&E determined that replacement of this segment was more expensive due to the segment located within a short confined space and would also require a deep horizontal directional drill (HDD), therefore the Project Team redesigned the section as a hydrotest project.
 - b. During the engineering and design stage, SoCalGas and SDG&E further reduced the scope of Category 4 Criteria mileage by reducing the MAOP of the line.
 - c. During construction, SoCalGas and SDG&E determined that it was necessary to relocate both test ends, resulting in the addition of Incidental mileage to the scope of the Project.
4. Final Project Scope: The final project scope consists of a 0.212 mile Hydrotest, a small-diameter lateral abandonment, and a tap valve replacement. The Accelerated mileage consists of 0.111 miles of Phase 2B pipe, and 0.055 miles of Incidental pipe.

B. Decision Tree Analysis

SoCalGas and SDG&E performed a PSEP Decision Tree analysis of Supply Line 31-09 and initially confirmed the project design should commence as a Replacement Project.

Segments of less than 1,000 feet are identified for replacement under the approved PSEP Decision Tree because, for short segments of pipe, the logistical costs associated with pressure testing (for example, permitting, construction, water handling, and service disruptions for a non-looped system) can approach or exceed the cost of replacement.

Pipeline Safety Enhancement Plan Final Report
Supply Line 31-09 Hydrotest Project

In such circumstances, replacement affords a more cost-effective approach to achieving compliance with D.11-06-017 while providing equal safety enhancement benefits. Moreover, installation of the new segment can usually be performed while the existing service is maintained to customers, thereby avoiding service disruptions that may otherwise occur during pressure testing.

In this instance, due to complex conditions related to replacement of the segment, such as a span across a waterway and proximity to a railroad, SoCalGas and SDG&E determined that pressure testing was the more prudent and less expensive approach to address the scope of the Project, as described below. Key considerations that support SoCalGas and SDG&E's determination to pressure test this segment include:

1. TVR Analysis: SoCalGas and SDG&E considered both Hydrotest and Replacement scenarios.
2. TVR Results: Analysis showed it was more cost efficient to perform a hydrotest.
3. Piggability: Piggable.
4. Existing Pipe Attributes: In-Line-Inspection (ILI) data did not indicate any anomalies or features that required replacement.
5. Pipe Vintage: 1969.
6. Longseam Type: Unknown.

Pipeline Safety Enhancement Plan Final Report
Supply Line 31-09 Hydrotest Project

7. Site Observation: The following observations, identified either visually or through Underground Service Alert markings, posed engineering complexities and/or risk:
 - a. Underground and overhead electric lines;
 - b. Multiple underground utilities;
 - c. Union Pacific Railroad crossing (UPRR);
 - d. San Jose Creek Channel crossing; and
 - e. A heavily-trafficked project location.

C. Engineering, Design, and Planning Factors

SoCalGas and SDG&E reviewed pipeline drawings and other information, contacted internal planning groups, communicated with external stakeholders, conducted survey activities, including reviewing public records, potholing, ground penetrating radar (GPR) of the area to confirm the presence of underground utilities and substructures, and completed a site walk. Key factors that influenced the engineering and design of the Project are as follows:

1. Shut-In Analysis: The Project Team determined the line could be shut-in for pressure testing under the following circumstances:
 - a. During an off-peak season, identified as June through September; and
 - b. In coordination with non-core customers.

Pipeline Safety Enhancement Plan Final Report
Supply Line 31-09 Hydrotest Project

2. Customer Impact: There was no impact to core customers served by the line, as they could be served by other lines or back-fed behind the shut-in sections. Two non-core customers that were impacted were:
 - a. Bottling Plant: SoCalGas and SDG&E reached out to this customer and coordinated the construction schedule so that a shut-in of up to one month would not impact its operations.
 - b. Power Generation Plant: Initially, SoCalGas and SDG&E planned and coordinated construction activity to take place in September of the following year to coincide with this customer's regularly scheduled maintenance activities. Due to late-season hot weather events, however, the customer deferred its maintenance activities. SoCalGas and SDG&E determined the Project timing should not be delayed any further due to the approaching winter demand. Once SoCalGas and SDG&E determined the cost to provide LNG service, the customer decided to decline service, take an outage, and went offline during the shut-in period.
3. Known Substructures: SoCalGas and SDG&E designed this project at a pipe depth of 42 inches, but through potholing, the Project Team determined that the actual depth to the top of the pipe was over 11 feet, which meant that engineering shoring would be required. Underground utilities were located within the same alignment by both Underground Service Alert and GPR, but did not require a change to the design.

Pipeline Safety Enhancement Plan Final Report
Supply Line 31-09 Hydrotest Project

4. Environmental: The water source for this project was a municipal fire hydrant, and the water was stored in water storage tanks. The Project Team took the following water disposal options into consideration:
- a. Option 1: Transfer the water to another project after the hydrotest is complete, if the water is tested as contaminant-free;
 - b. Option 2: Dispose of the water at a treatment facility that can accommodate polychlorinated biphenyls and other potential contaminants up to a certain level for a moderate cost; or
 - c. Option 3: Consider the water as hazardous waste and dispose of it at a facility that can accommodate hazardous materials for a substantial cost.

The risk the water might contain contaminants at levels that exceed non-hazardous thresholds was identified as possible, but not probable. Therefore, the Project Team planned for Option 2 as the primary path forward.

5. Taps: Prior to conducting the hydrotest, a small-diameter lateral, Supply Line 31-09-B, was abandoned. In analyzing the attributes of this pipe, the Project Team determined the existing tap valve could not withstand the proposed hydrotest pressure of the mainline, therefore, SoCalGas and SDG&E decided to permanently abandon the lateral by installing a new spool piece into Supply Line 31-09 in its place.

D. Scope Changes

SoCalGas and SDG&E did not make any notable scope changes during detailed design.

Pipeline Safety Enhancement Plan Final Report
Supply Line 31-09 Hydrotest Project

III. CONSTRUCTION

A. Construction Contractor Selection

The Project Team prepared an initial cost estimate based on the preliminary design. Following completion of the engineering, design, and planning activities described above, the Project Team directed the Performance Partner to prepare cost estimates based on a more detailed engineering design package. As indicated above, there were no notable changes in scope between the time when the Project Team prepared the preliminary cost estimate and when the Performance Partner prepared and submitted its Target Price Estimate. SoCalGas and SDG&E awarded the construction contract to the Performance Partner.

1. SoCalGas and SDG&E’s Preliminary Construction Cost Estimate (*confidential*):
SoCalGas and SDG&E’s preliminary cost estimate for construction was [REDACTED].
2. Construction Contractor’s Target Price Estimate (*confidential*): The Construction Contractor’s cost estimate was [REDACTED], which was [REDACTED] than SoCalGas and SDG&E’s preliminary cost estimate for construction.

B. Construction Schedule

Table 3: Construction Timeline

Construction Start Date	07/20/2015
Construction Completion Date	10/13/2015
NOP Date	09/23/2015

Pipeline Safety Enhancement Plan Final Report
Supply Line 31-09 Hydrotest Project

C. Changes During Construction

The conditions summarized below were encountered during construction. Activities to address or mitigate these conditions resulted in approximately \$16,000⁵ in change orders.

1. Environmental Abatement: The Construction Contractor discovered hydrocarbon-contaminated soil at the north test end during excavation activities. The Project Team determined the most prudent action to avoid abatement related costs would be to relocate the test end. This mitigation activity added costs and time to the schedule for testing the soil to confirm the presence of contaminants, and backfilling and restoring the original location.
2. Access: The relocation of the north test end required acquisition of additional land. The request for workspace was easily accommodated because the same owner, with whom SoCalGas and SDG&E were already entered into a land agreement with for another portion of this Project, owned the new location.
3. Permit Conditions: The Los Angeles County Inspector requested an asphalt grinder so that the steel traffic control plates would be set flush with the pavement at the north test end.

⁵ This figure is net of credits.

Pipeline Safety Enhancement Plan Final Report
Supply Line 31-09 Hydrotest Project

4. Field Design Change:

- a. During construction, SoCalGas and SDG&E added a lateral, Supply Line 31-09-H, to the scope of the mainline hydrotest. The original south test end was located in Union Pacific Railroad (UPRR) right of way (ROW), and an entry permit was not granted, therefore pushing the test end further south, which included the tap within the limits of the mainline test. It was then decided to include the lateral with the mainline hydrotest for ease of constructability and to further ensure the integrity of the system.
- b. The existing tap valve to the Supply Line 31-09-H lateral was replaced prior to hydrotest when the Project Team determined that the pressure rating of the pre-existing tap valve was below the minimum test pressure.

Pipeline Safety Enhancement Plan Final Report Supply Line 31-09 Hydrotest Project

Figure 3: Original Supply Line 31-09-H Lateral at Supply Line 31-09
South Hydrotest Test End

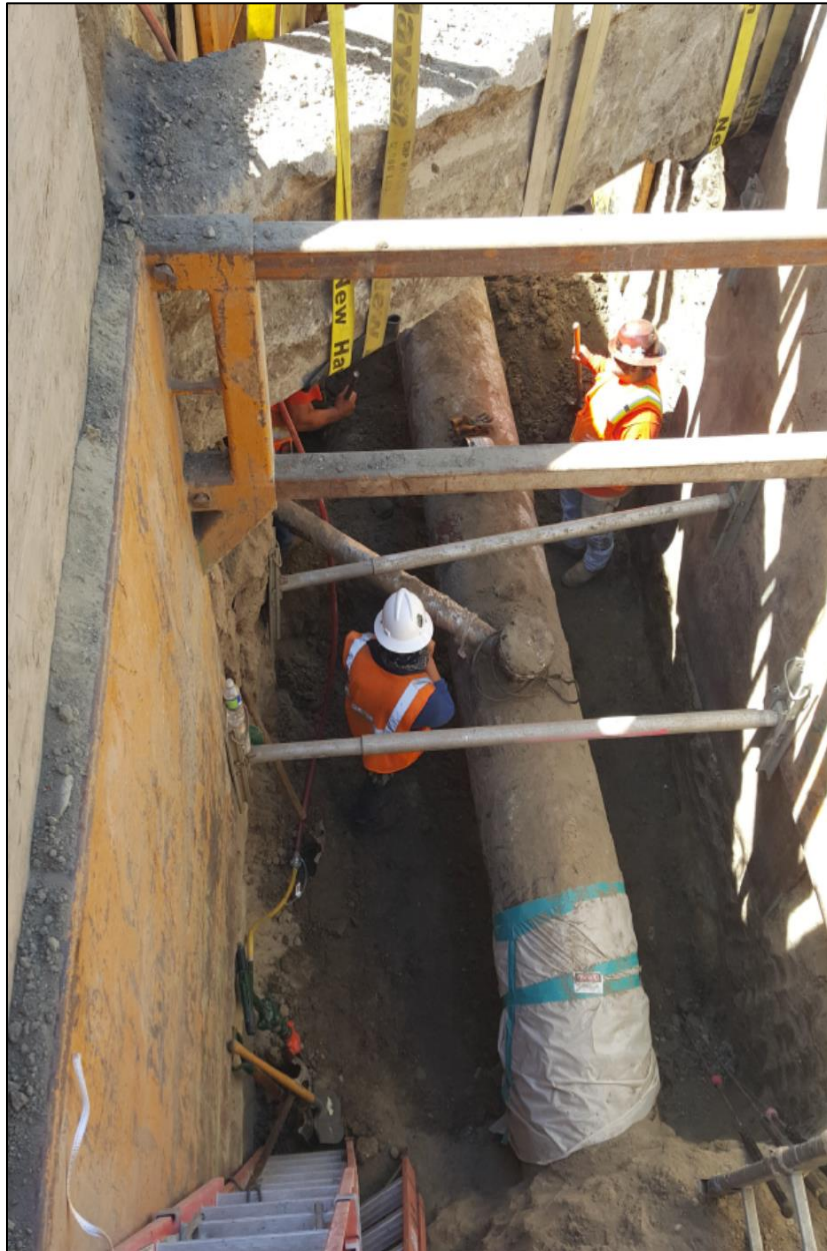

Pipeline Safety Enhancement Plan Final Report Supply Line 31-09 Hydrotest Project

Figure 4: Tied-In Supply Line 31-09-H Lateral at Supply Line 31-09
South Hydrotest Test End



Pipeline Safety Enhancement Plan Final Report
Supply Line 31-09 Hydrotest Project

Figure 5: South End Test Head



Pipeline Safety Enhancement Plan Final Report
Supply Line 31-09 Hydrotest Project

D. Commissioning and Site Restoration

Commissioning activities include site restoration, final inspection and placement of the pipeline back into service, transportation and disposal of hydrotested water and hazardous material, and site demobilization. Closeout activities include development of final drawings, finalization of a reconciliation package, and updates to company recordkeeping system to reflect the completed scope of work.

Pipeline Safety Enhancement Plan Final Report
Supply Line 31-09 Hydrotest Project

IV. PROJECT COSTS

A. Cost Avoidance Actions

SoCalGas and SDG&E exercised due diligence in the planning, design, and construction activities for this project to minimize or avoid costs when prudent to do so. As discussed above, the Project Team conducted a site visit to identify and incorporate discernible site conditions into the engineering, design, and planning of the Project. A specific example of cost avoidance actions taken on this project is SoCalGas and SDG&E's decision to reuse the test heads from the Line 1015 Hydrotest Project for this project, to avoid incurring additional costs to fabricate new test heads. This resulted in a cost savings for material and labor, and shortened the schedule by eliminating the need to fabricate and test new test heads.

B. Cost Estimate

Based on the preliminary design, once the project scope was confirmed and engineering, design, and planning activities were underway, SoCalGas and SDG&E prepared an estimate of the Direct Costs of the Project in the amount of \$1,944,646. This estimate was prepared in February of 2015, using the "SCG Pipeline Estimate Template Rev 1" estimating tool, the most current version of the PSEP Estimate Template at the time. The Project Team considered the conditions known at the time to prepare the preliminary Direct Cost estimate. This estimate reflects the projected Labor, Material, and Services costs anticipated to be incurred to execute the Project.

SoCalGas and SDG&E estimated Indirect Costs of the Project based on the estimated Direct Costs and other project-related variables.

Pipeline Safety Enhancement Plan Final Report
Supply Line 31-09 Hydrotest Project

C. Actual Direct and Indirect Costs

Actual Direct Costs reflect the Labor, Material, and Service costs incurred to execute the Project. Actual Indirect Costs reflect costs for incremental overhead loaders in accordance with Company overhead allocation policies. The total loaded cost of the Project is \$3,651,114.

Table 4: Estimated and Actual Direct Costs and Variances

Direct Costs (\$)	Estimate	Actuals	Delta Over/(Under)
Company Labor	198,000	178,165	(19,835)
Materials	376,539	26,424	(350,115)
Construction Contractor	873,405	929,531	56,126
Construction Management & Support	62,260	374,439	312,179
Environmental	4,840	138,814	133,974
Engineering & Design	110,000	1,265,595	1,155,595
Project Management & Services	111,320	198,025	86,705
ROW & Permits	2,750	29,682	26,932
GMA	205,532	303,050	97,518
Total Direct Costs	1,944,646	3,443,725	1,499,079

Table 5: Estimated and Actual Indirect Costs, Total Costs, and Variances

Indirect Costs / Total Costs (\$)	Estimate	Actuals	Delta Over/(Under)
Overheads	508,178	207,389	(300,789)
AFUDC	35,169	-	(35,169)
Property Taxes	-	-	-
Total Indirect Costs	543,347	207,389	(335,958)
Total Direct Costs	1,944,646	3,443,725	1,499,079
Total Loaded Costs	2,487,993	3,651,114	1,163,121

Pipeline Safety Enhancement Plan Final Report
Supply Line 31-09 Hydrotest Project

D. Disallowance

For this hydrotest project, SoCalGas and SDG&E identified a total of 239 feet of pipe as being installed post-1955 and lacking pressure test records that provide the minimum information to demonstrate compliance with industry standards or then-applicable strength testing and recordkeeping requirements. Of the 0.201 miles of pipeline that were pressure tested, 239 feet (22.48%) of test mileage are disallowed, therefore \$820,900 of total project O&M costs are disallowed from recovery.

Pipeline Safety Enhancement Plan Final Report
Supply Line 31-09 Hydrotest Project

V. CONCLUSION

SoCalGas and SDG&E enhanced the safety of their integrated natural gas transmission system by prudently executing the Supply Line 31-09 Hydrotest Project. Through this Hydrotest Project, SoCalGas and SDG&E successfully hydrotested 0.212 miles of pipeline in the City of Industry. The total loaded cost of the Project is \$3,651,114.

SoCalGas and SDG&E executed this project prudently through engaging in scope validation efforts that reduced project mileage, addressing field conditions, coordinating outage schedules with non-core customers, and safely designing and executing this project in an area congested with underground and aboveground third-party facilities.

SoCalGas and SDG&E engaged in prudent cost avoidance efforts by executing the more cost effective hydrotest option rather than replacing this short segment, and reusing test heads from a previous project rather than fabricating new ones for this Project.

End of Supply Line-31-09 Hydrotest Project Final Report

Pipeline Safety Enhancement Plan Final Report
Supply Line 32-21 Section 1 Hydrotest Project

I. SUPPLY LINE 32-21 SECTION 1 HYDROTEST PROJECT

A. Background and Summary

Supply Line 32-21 Section 1 is a predominantly [REDACTED] diameter transmission line that runs approximately 1.6 miles through a highly developed and heavily congested corridor in the City of Pasadena. The pipeline is primarily routed across a Class 3 location. This report describes the activity associated with the Supply Line 32-21 Section 1 Hydrotest Project, that consists of the hydrotest of 1.561 miles of pipeline, the replacement of one mainline valve (MLV) and bridle, and the replacement of two existing pipe laterals. The specific attributes of this Project are detailed in Table 1 below. The total loaded cost of the Project is \$10,371,896.

The Supply Line 32-21 Section 1 Hydrotest Project is a component of Supply Line 32-21, that was identified in the 2011 PSEP filing¹ as a 10.231 mile replacement project. The pipeline is located in the cities of Alhambra, Pasadena, and San Marino. For project manageability purposes and due to unique characteristics related to non-contiguous portions of the pipeline, SoCalGas and SDG&E divided the Supply Line 32-21 filing into three project sections to be executed and managed individually. This report summarizes activity and actual costs related to Section 1 only. Sections 2 and 3 will be reported separately and submitted in the same reasonableness review.

¹ See Amended PSEP of SoCalGas and SDG&E, submitted December 2, 2011, in R.11-02-019 and subsequently transferred to A.11-11-002.

Pipeline Safety Enhancement Plan Final Report
Supply Line 32-21 Section 1 Hydrotest Project

Table 1: General Project Information

Project Name	Supply Line 32-21 Section 1		
Project Type	Hydrotest		
Length	1.561 miles		
Location	Pasadena		
Class	3		
MAOP (<i>confidential</i>)	[REDACTED]		
Pipe Vintage	1948		
Construction Start	05/29/2015		
Construction Finish	10/12/2015		
Original Pipe Diameter (<i>confidential</i>)	[REDACTED]		
New Diameter (<i>confidential</i>)	N/A		
Original SMYS ² (<i>confidential</i>)	[REDACTED]		
New SMYS (<i>confidential</i>)	[REDACTED]		
Project Costs (\$)	Capital	O&M	Total
Loaded Project Costs	1,082,818	9,289,078	10,371,896
Disallowed Costs	-	-	-

² Highest percentage of Specified Minimum Yield Strength (SMYS) of Category 4 Criteria pipe.

Pipeline Safety Enhancement Plan Final Report
Supply Line 32-21 Section 1 Hydrotest Project

B. Maps and Images

Figure 1: Satellite Image of Supply Line 32-21 Sections 1, 2, and 3

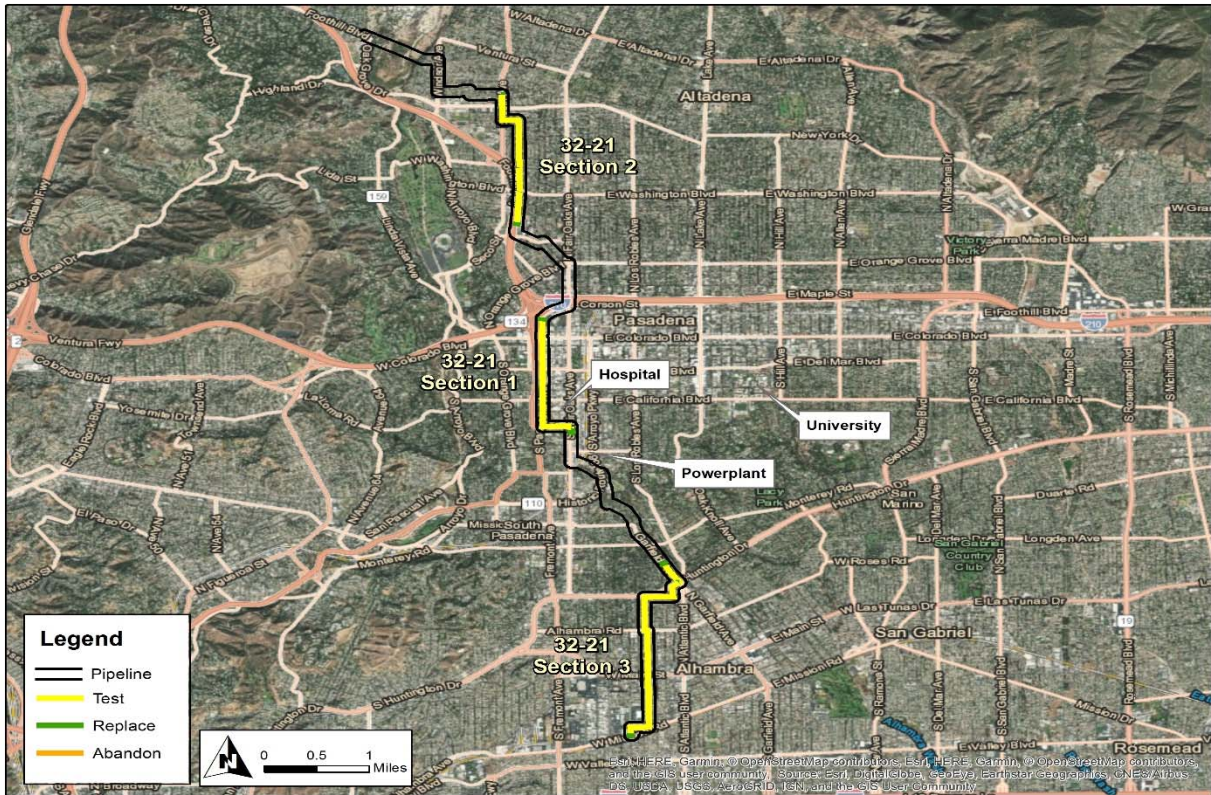

Pipeline Safety Enhancement Plan Final Report
 Supply Line 32-21 Section 1 Hydrotest Project

Figure 2: Overview Map of Supply Line 32-21 Sections 1, 2, and 3

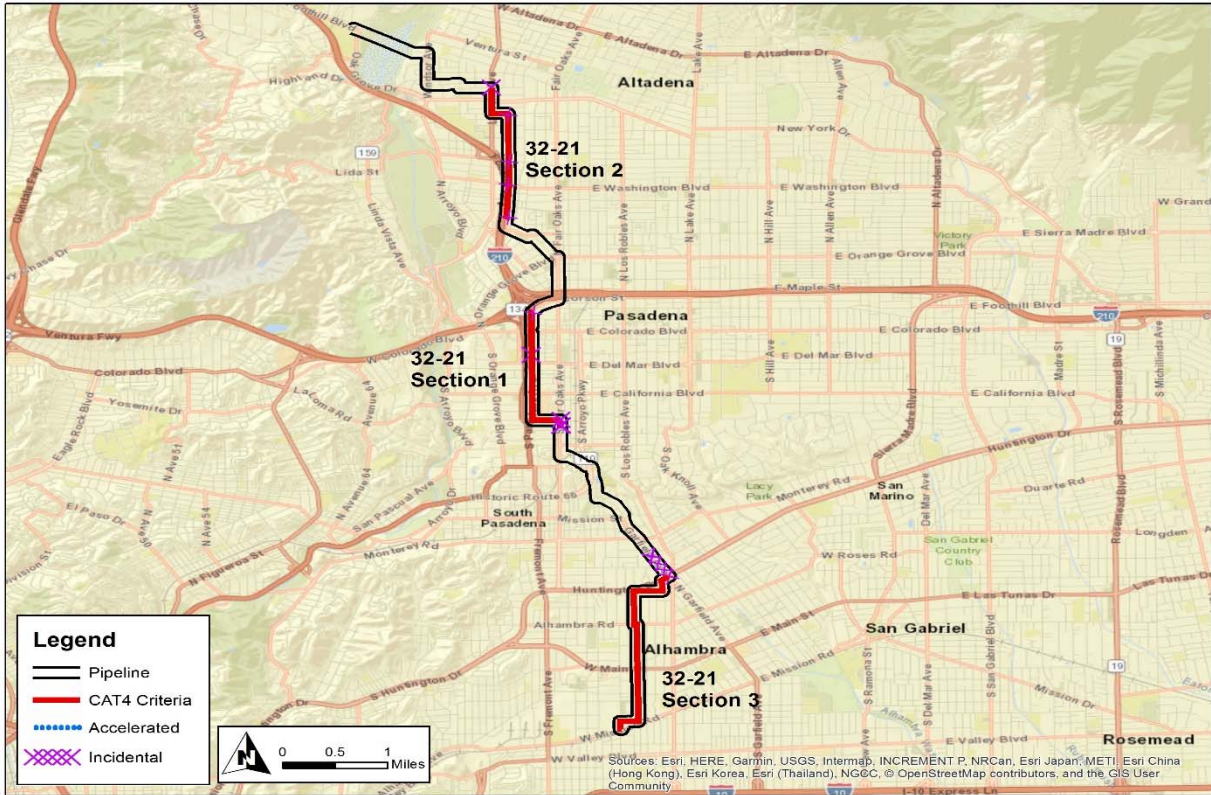

Pipeline Safety Enhancement Plan Final Report
Supply Line 32-21 Section 1 Hydrotest Project

Figure 3: Satellite Image of Supply Line 32-21 Section 1 Hydrotest Project

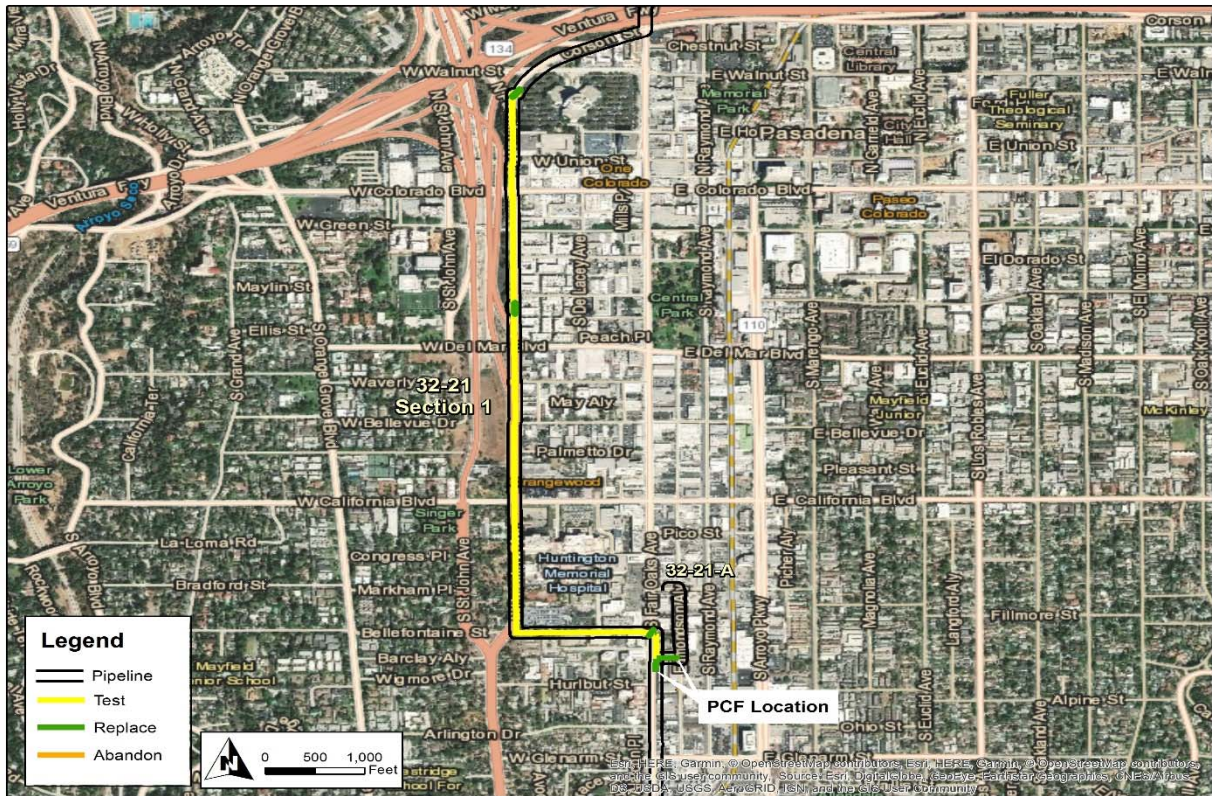

Pipeline Safety Enhancement Plan Final Report
 Supply Line 32-21 Section 1 Hydrotest Project

Figure 4: Overview Map of Supply Line 32-21 Section 1 Hydrotest Project

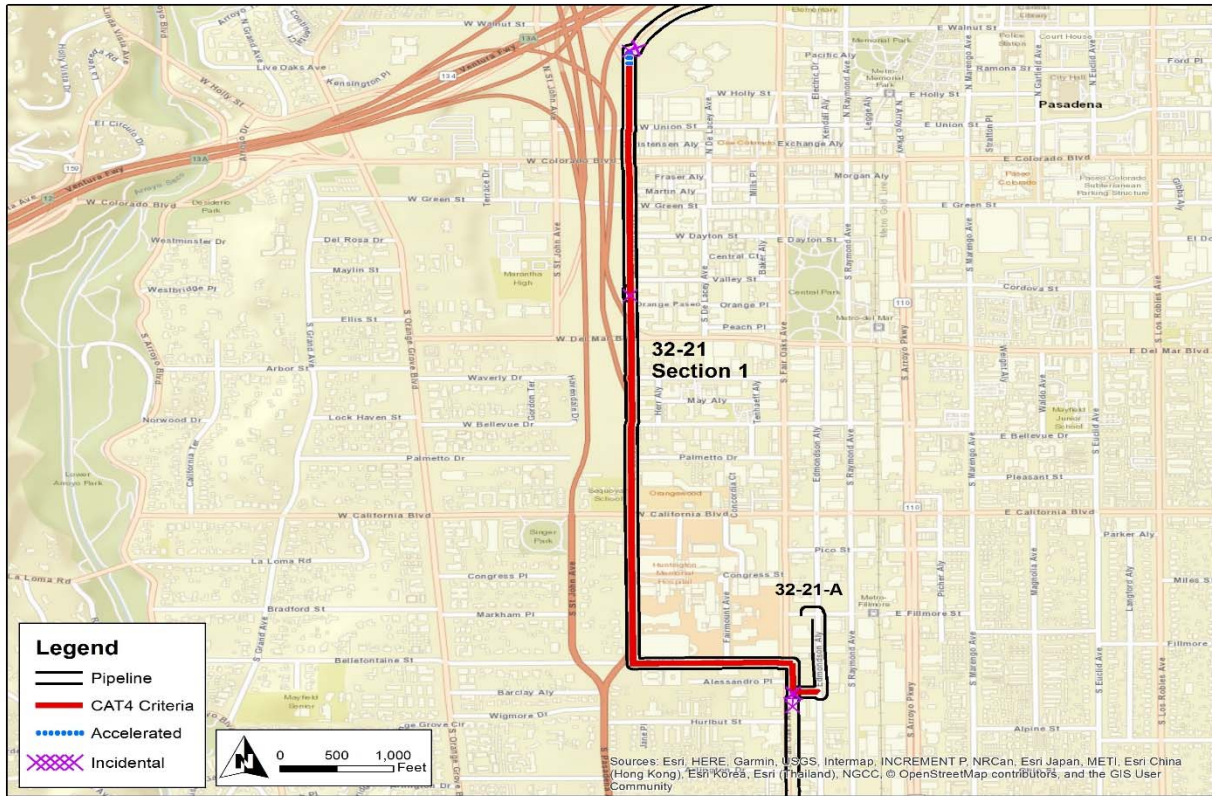

Pipeline Safety Enhancement Plan Final Report
Supply Line 32-21 Section 1 Hydrotest Project

II. ENGINEERING, DESIGN, AND PLANNING

A. Project Scope

Table 2: Mileage Information

	Criteria	Accelerated ³	Incidental	New	Total ⁴
Final Mileage	1.486 mi.	0.028 mi.	0.043 mi.	0.004 mi.	1.561 mi.
	7,847 ft.	146 ft.	227 ft.	20 ft.	8,241 ft.

SoCalGas and SDG&E presented a conceptual project scope in workpapers supporting the 2011 PSEP filing.⁵ Prior to initiating execution of the Project in 2015, SoCalGas and SDG&E reviewed existing pipeline records to validate the scope of the Project. During the Engineering, Design, and Planning phase, SoCalGas and SDG&E further refined the scope. This progression of the project scope is summarized as follows:

1. 2011 PSEP Filing: SoCalGas and SDG&E identified Supply Line 32-21 as a Phase 1A Replacement Project comprised of 8.590 miles of Category 4 Criteria pipe and 1.641 miles of Accelerated pipe.
2. Scope Validation:
 - a. Through scope validation activities, after the 2011 filing and before initiating execution of the Project, SoCalGas and SDG&E successfully reduced the scope of the Project by 3.431 miles of Category 4 Criteria pipe for all Project sections.
 - b. SoCalGas and SDG&E reviewed the MAOP of the pipeline and determined that a derate of the pipeline MAOP would not negatively impact the system. As a result, this pipeline was derated, thus reducing Category 4 Criteria mileage.

³ Accelerated mileage includes Phase 2B pipe. Phase 2B includes pipelines without record of a pressure test to modern-Subpart J-Standards (Phase 2B). The Accelerated mileage was included to realize efficiencies and to enhance project constructability.

⁴ Values may not add to total due to rounding.

⁵ See Amended PSEP of SoCalGas and SDG&E, submitted December 2, 2011, in R.11-02-019 and subsequently transferred to A.11-11-002.

Pipeline Safety Enhancement Plan Final Report
Supply Line 32-21 Section 1 Hydrotest Project

3. Engineering, Design, and Constructability:
 - a. Based on the PSEP Decision Tree and Test versus Replace (TVR) analysis, detailed below, SoCalGas and SDG&E confirmed the project scope for Section 1 as a replacement. SoCalGas applied for the necessary permits, but due to the risk associated with permitting terms presented by the City of Pasadena, it was determined that the risk to company employees and the community was unacceptable. After additional thorough research, hydrotesting was deemed as the safest and most viable option for this project. The engineering and design process restarted as a hydrotest project.
 - b. A new bridle was installed to reconnect Lateral 32-21-A.
 - c. New mileage is a result of alignment offset.
4. Final Project Scope: The final project scope consists of a 1.561 mile hydrotest, replacement of one MLV and bridle, and the replacement of two lateral valves for Supply Line 32-21-F and Supply Line 32-21-A. There are 146 feet of Accelerated Phase 2B and 227 feet of Incidental pipe.

B. Decision Tree Analysis

SoCalGas and SDG&E performed a PSEP Decision Tree analysis of Supply Line 32-21 Section 1 and initially confirmed the project design should commence as a Replacement Project.

For pipeline segments longer than 1,000 feet in length, under the approved PSEP Decision Tree, SoCalGas and SDG&E complete a preliminary review to determine whether SoCalGas and SDG&E can manage customer service impacts if the pipeline segment is taken out of service for a period of two to six weeks to complete pressure testing.

Pipeline Safety Enhancement Plan Final Report
Supply Line 32-21 Section 1 Hydrotest Project

Where mitigation of customer impacts to remove the line from service for pressure testing is feasible, SoCalGas and SDG&E compare the costs, constructability, risks, and benefits of pressure testing and replacement to determine whether pressure testing or replacement is the more prudent option.

Through this Decision Tree analysis, SoCalGas and SDG&E identified replacement as the more prudent option (prior to identifying the safety issues associated with the permit constraints). Key considerations that support SoCalGas and SDG&E's determination to replace this segment include:

1. TVR Scenarios: After performing a TVR, the Project Team originally recommended replacement; however, during engineering, design, and planning, and due to jurisdiction constraints (explained below), the recommendation was revised to hydrotest the line.
2. Piggability: Non-piggable.
3. Pipe Vintage: 1948.
4. Site Observation: Highly sensitive nature of any street work in and around Old Town Pasadena.
5. Existing Pipe Attributes: History of leaks and miter bends.

Pipeline Safety Enhancement Plan Final Report
Supply Line 32-21 Section 1 Hydrotest Project

6. Other Identified Risks: Although initially SoCalGas and SDG&E identified and designed the Project as a replacement, after permits were applied for, the scope was changed, and SoCalGas and SDG&E executed the Project as a hydrotest. This was due to the City of Pasadena's requirement to have the replacement pipe trench shared with their planned high voltage underground power line project. SoCalGas and SDG&E could not comply with this condition due to safety issues and risks related to working on and within the vicinity of a high pressure natural gas line and a high voltage power line. Therefore, after additional review of historical reports, thorough research, and identifying mitigation needed to safely pressure test this pipe, the engineering and design process restarted as a hydrotest project, in order to achieve PSEP's goal of validating safety of the pipeline.

C. Engineering, Design, and Planning Factors

SoCalGas and SDG&E reviewed pipeline drawings and other information, contacted internal planning groups, communicated with external stakeholders, conducted survey activities, including reviewing public records and ground penetrating radar of the area to confirm the presence of underground utilities and substructures, and completed a pre-design site walk. Key factors that influenced the engineering and design of the Project before and during construction are as follows:

1. Shut-In Analysis: The Project Team completed a Request for Engineering Review (RER) analysis and concluded the line could be shut-in, but with system limitations identified by the Operating District. The shut-in would have affected both major gas consumers, [REDACTED]. To avoid impacts to these consumers, the Project Team installed stopple fittings to limit the areas affected by isolating the line – this avoided shutting-in the power plant, and a short temporary bypass was created for [REDACTED] to avoid a complete shut-in.

Pipeline Safety Enhancement Plan Final Report
Supply Line 32-21 Section 1 Hydrotest Project

2. Customer Impact: The RER analysis concluded that work had to be completed in spring or summer conditions as there are higher load demands by customers served off of the lateral to Supply Line 32-21-A and Supply Line 32-21-F in fall and winter conditions. To avoid service interruptions to both, core and non-core customers, the Project Team originally planned a temporary bypass for Supply Line 32-21-A to maintain service.
3. Known Substructures: The City of Pasadena did not allow potholing of its streets or properties. The Project Team did preliminary verification via paint marks and above grade signs of substructures (i.e. manholes, valve cans, etc.) and ground penetrating radar (GPR). GPR results revealed that adjustments were required from the original bridle configuration at Fair Oaks Avenue due to existing obstructions and pipe depth; however, in these circumstances, where the underground utility corridor is heavily congested, GPR cannot identify all substructures.
4. Permit Restrictions: Permitting requirements for the hydrotest project did not present any out-of-the-ordinary restrictions other than a holiday moratorium.
5. Environmental: The Project Team anticipated abatement activities for coal tar/asbestos, along with hydrotest water discharge; neither activity required a long lead environmental permit.
6. Taps: The Project Team design called for two laterals and removal of four stubs.
7. Bypass: To avoid service interruptions to both core and non-core customers , the Project Team planned a temporary bypass for Supply Line 32-21-A to maintain service.

Pipeline Safety Enhancement Plan Final Report
Supply Line 32-21 Section 1 Hydrotest Project

D. Scope Changes

Through engineering, design, and planning activities, SoCalGas and SDG&E determined that changes in scope were appropriate to enhance the design of the Project and address engineering factors. As a result, the preliminary cost estimate does not fully reflect the final scope.

As described above, the engineering and design plans progressed into pre-construction when the scope of this project changed from a replacement to a hydrotest project due to unfavorable permit provisions presented by the City of Pasadena. As a result, SoCalGas and SDG&E's preliminary estimate reflects the costs for hydrotesting Supply Line 32-21 Sections 1, 2, and 3 combined and not hydrotesting Supply Line 32-21 Section 1 by itself.

Pipeline Safety Enhancement Plan Final Report
Supply Line 32-21 Section 1 Hydrotest Project

III. CONSTRUCTION

A. Construction Contractor Selection

The Project Team prepared an initial cost estimate based on the preliminary design. Following completion of the engineering, design, and planning activities described above, the Project Team directed the Performance Partner to prepare cost estimates based on a more detailed engineering design package, that included the updated design described in the discussion of notable Scope Changes above. SoCalGas and SDG&E awarded the construction contract to the Performance Partner.

1. SoCalGas and SDG&E’s Preliminary Construction Cost Estimate (*confidential*):
SoCalGas and SDG&E’s preliminary cost estimate for construction was [REDACTED] that included cost estimate for all three sections of Supply Line 32-21.
2. Construction Contractor’s Target Price Estimate (*confidential*): The Construction Contractor’s cost estimate was [REDACTED] for Section 1 only.

B. Construction Schedule

Table 3: Construction Timeline

Construction Start Date	05/29/2015
Construction Completion Date	10/12/2015
NOP Date	09/04/2015

Pipeline Safety Enhancement Plan Final Report
Supply Line 32-21 Section 1 Hydrotest Project

C. Changes During Construction

The conditions summarized below were encountered during construction. Despite SoCalGas and SDG&E's diligent survey and planning efforts, due to the heavy underground congestion of multiple utilities buried underground, and outdated inaccurate records, there were many unknown conditions that led to a number of field design changes made during construction. Activities to address or mitigate these conditions resulted in approximately \$1,275,000 in change orders.

1. Constructability Issues: The Project Team encountered several constructability issues during construction, as follows:
 - a. The Project Team uncovered an abandoned SoCalGas pipeline that was not identified on the as-built drawings west of Supply Line 32-21-A. The line interfered with the original bridle configuration and new line installation, so it had to be removed.
 - b. The Project Team had to relocate the planned stopple location on Supply Line 32-21 at Fair Oaks Avenue for the following reasons:
 - i. The line was shallower than planned, installation of the stopple would interfere with a driveway to a local business; therefore, the Project Team relocated the stopple 50 feet south of Fair Oaks Avenue.
 - ii. During x-ray inspection of the line at the new location, the Project Team identified anomalies along the long seam. Upon inspection the Project Team decided to excavate further south to the next girth weld to determine whether the location would be acceptable. This process took place several times, and after an additional 150 feet of excavation, the Project Team identified an acceptable location.

Pipeline Safety Enhancement Plan Final Report
Supply Line 32-21 Section 1 Hydrotest Project

The Project Team replaced the pipe between the bridle location and the new stopple location.

- c. Due to the poor pipe conditions on Supply Line 32-21 and Supply Line 32-21-A, the Project Team had to modify the bypass between the two lines from the original planned configuration, resulting in part of the temporary bypass becoming the new permanent Supply Line 32-21-A.
 - d. At Bellefontaine Street, the Project Team needed to cut out an existing tee and replace it with an elbow. However, when the Project Team exposed the tee, the existing conditions did not match the plans. There were several utility conflicts, and the Project Team could not install the elbow as planned. The Project Team had to expand the tie-in and change the design to clear existing utilities.
 - e. The Project Team confirmed valve properties at Supply Line 32-21-F and conducted potholing to determine the rating and confirm it can be tested through. The Project Team found the MLV to be ANSI 300, which could withstand the proposed test pressures; however, the valve would not maintain 100% closure. The Project Team attempted to repair the valve, but eventually had to replace it prior to conducting the hydrotest.
2. Customer Impact Mitigation: The Project Team planned a temporary bypass for Supply Line 32-21-A to maintain the feed to [REDACTED] and other core customers, but due to the condition of the existing lateral pipe, part of the bypass became a permanent replacement. The Project Team installed and used stopple fittings at both ends of the hydrotest for shut-in to avoid customer interruption.
 3. Field Design Changes: As described above, the additional excavations required additional coverage with traffic rated steel plates.

Pipeline Safety Enhancement Plan Final Report
Supply Line 32-21 Section 1 Hydrotest Project

4. Material Delivery Delays:

- a. Materials requested were not delivered on the requested dates or specified times. Deliveries were made after scheduled work hours; therefore, overtime charges were incurred.
- b. The Project Team procured additional materials as field requisitions or transferred them from other projects for additional scoped items. These items included, but were not limited to, small size fittings (nuts, bolts, gaskets, flanges, and nipple), additional pipe, and valves.

5. Permit Conditions:

- a. Under its “no k-rail mandate,” the City of Pasadena did not allow for the plan to secure and barricade the stopple installed for Supply Line 32-21 with k-rails. The city agreed to the use of a two-ton attenuator truck parked over the stopple as protection. Neither condition impacted the overall construction schedule.
- b. As described previously, the construction schedule was significantly delayed because although the city would have approved the Issued for Construction (IFC) replacement project plans and issued the permit, it would have been with the condition that the pipeline replacement project share the trench with an electric project. SoCalGas and SDG&E would not agree with these terms for safety reasons and redesigned the project as a hydrotest.

Pipeline Safety Enhancement Plan Final Report
Supply Line 32-21 Section 1 Hydrotest Project

D. Commissioning and Site Restoration

Commissioning activities include restoration of the site, final inspection and placement of the pipeline back into service, transportation and disposal of hydrotested water and hazardous material, and site demobilization. Closeout activities include development of final drawings, finalization of a reconciliation package, and updates to company recordkeeping systems to reflect the completed scope of work.

IV. PROJECT COSTS

A. Cost Avoidance Actions

SoCalGas and SDG&E exercised due diligence in the planning, design, and construction activities for this project to minimize or avoid costs when prudent to do so. As discussed above, the Project Team conducted a site visit to identify and incorporate discernible site conditions into the engineering, design, and planning of the Project. A specific example of cost avoidance action taken on this project is the use of ground water collected and reused water from another PSEP hydrotest project for the mainline hydrotest. Once the Project Team completed the hydrotest, the water could not be reused and was hauled off for proper disposal.

B. Cost Estimates

Based on the preliminary design, once the project scope was confirmed and engineering, design, and planning activities were underway, SoCalGas and SDG&E prepared an estimate of the Direct Costs of the Project (that includes all three sections) in the amount of \$17,462,134. This estimate was prepared in March of 2015, using the “SCG Pipeline Estimate Template Rev 0” estimating tool, the most current version of the PSEP Estimate Template at the time. The Project Team considered the conditions known at the time to prepare the preliminary Direct Cost estimate. This estimate reflects the projected Labor, Material, and Services costs anticipated to be incurred to execute the hydrotest project for Supply Line 32-21, Sections 1, 2, and 3.

SoCalGas and SDG&E estimated Indirect Costs of the Project based on the estimated Direct Costs and other project related variables.

Pipeline Safety Enhancement Plan Final Report
Supply Line 32-21 Section 1 Hydrotest Project

C. Actual Direct and Indirect Costs

Actual Direct Costs reflect the Labor, Material, and Services costs incurred to execute the Project. Actual Indirect Costs reflect costs for incremental overhead loaders in accordance with Company overhead allocation policies. The total loaded cost of the Project (Section 1 only) is \$10,371,896.

Table 4: Estimated and Actual Direct Costs and Variances

Direct Costs (\$)	Estimate	Actuals	Delta over/(under)
Company Labor	779,037	428,298	(350,739)
Materials	711,851	318,019	(393,832)
Construction Contractor	8,710,722	2,434,632	(6,276,090)
Construction Management & Support	1,384,957	1,331,688	(53,269)
Environmental	643,198	532,138	(111,060)
Engineering & Design	1,366,485	2,102,335	735,850
Project Management & Services	1,571,493	837,992	(733,501)
ROW & Permits	448,800	365,276	(83,524)
GMA	1,845,591	1,070,651	(774,940)
Total Direct Costs	17,462,134	9,421,029	(8,041,105)

Table 5: Estimated and Actual Indirect Costs, Total Costs, and Variances

Indirect Cost/Total Costs (\$)	Estimate	Actuals	Delta over/(under)
Overheads	4,418,668	590,266	(3,828,402)
AFUDC	2,348,027	316,543	(2,031,484)
Property Taxes	464,300	44,058	(420,242)
Total Indirect Costs	7,230,995	950,867	(6,280,128)
Direct Costs	17,462,134	9,421,029	(8,041,105)
Total Loaded Costs	24,693,129	10,371,896	(14,321,233)

Pipeline Safety Enhancement Plan Final Report
Supply Line 32-21 Section 1 Hydrotest Project

D. Disallowances

There was no disallowance for Supply Line 32-21 Section 1 as there were no post-1955 segments included in the Project without records that provide the minimum information to demonstrate compliance with then applicable industry standards or regulatory strength testing and recordkeeping requirements.

Pipeline Safety Enhancement Plan Final Report
Supply Line 32-21 Section 1 Hydrotest Project

V. CONCLUSION

SoCalGas and SDG&E enhanced the safety of their integrated natural gas transmission system by prudently executing the Supply Line 32-21 Section 1 Hydrotest Project.

Through this Hydrotest Project, SoCalGas and SDG&E successfully hydrotested 1.561 miles of high pressure transmission pipeline in the City of Pasadena. The total loaded cost of the Project is \$10,371,896.

SoCalGas and SDG&E executed this project prudently through maintaining service to customers, including a university and power plant; engaging in scope validation efforts that reduced project mileage; coordinating the reuse of test heads; redesigning the Project in response to permitting conditions that were unacceptable to SoCalGas that posed an unacceptable risk as a replacement project; identified and replaced a lateral valve that did not provide necessary gas isolation, replaced 244 feet of lateral piping, and finally mitigated several known and unknown irregularities in the pipe, such that the pressure test was completed successfully.

SoCalGas and SDG&E engaged in prudent cost avoidance efforts by overall scope validation efforts to reduce Category 4 mileage, coordinating reuse of water, ensuring minimal customer and community impacts, and safety testing on a major thoroughfare using a combination of internal and Performance Partner construction management to complete the safety enhancement work as soon as practicable.

End of Supply Line 32-21 Section 1 Hydrotest Project Final Report

Pipeline Safety Enhancement Plan Final Report
Supply Line 32-21 Section 2 Hydrotest Project

I. SUPPLY LINE 32-21 SECTION 2 HYDROTEST PROJECT

A. Background and Summary

Supply Line 32-21 Section 2 is a predominantly [REDACTED] diameter transmission line that runs approximately 1.6 miles through a highly developed and heavily congested corridor in the City of Pasadena. The pipeline is primarily routed across a Class 3 location. This report describes the activity associated with Supply Line 32-21 Section 2 Hydrotest Project, that consists of the hydrotest of 1.602 miles of pipeline, pipe and valve replacement, permanent abandonment of three taps and valves, and isolation of two taps prior to the hydrotest and valve replacements. The specific attributes of this Project are detailed in Table 1 below. The total loaded cost of the Project is \$5,500,364.

The Supply Line 32-21 Section 2 Hydrotest Project is a component of Supply Line 32-21, that was identified in the 2011 PSEP filing¹ as a 10.231 mile replacement project. The pipeline traverses the cities of Alhambra, Pasadena, and San Marino. For project manageability purposes and due to unique characteristics related to non-contiguous portions of the pipeline, SoCalGas and SDG&E divided the Supply Line 32-21 filing into three project sections to be executed and managed individually. This report summarizes activity and actual costs related to Section 2 only. Sections 1 and 3 will be reported separately and submitted in the same reasonableness review.

Pipeline Safety Enhancement Plan Final Report
Supply Line 32-21 Section 2 Hydrotest Project

Table 1: General Project Information

Project Name	Supply Line 32-21 Section 2		
Project Type	Hydrotest		
Length	1.602 miles		
Location	Pasadena		
Class	3		
MAOP (<i>confidential</i>)	[REDACTED]		
Pipe Vintage	1948		
Construction Start	06/06/2016		
Construction Finish	09/30/2016		
Original Pipe Diameter (<i>confidential</i>)	[REDACTED]		
New Diameter (<i>confidential</i>)	N/A		
Original SMYS ¹ (<i>confidential</i>)	[REDACTED]		
New SMYS (<i>confidential</i>)	[REDACTED]		
Project Costs (\$)	Capital	O&M	Total
Loaded Project Costs	760,561	4,739,803	5,500,364
Disallowed Costs	-	-	-

¹ Highest percentage of Specified Minimum Yield Strength (SMYS) of Category 4 Criteria pipe

Pipeline Safety Enhancement Plan Final Report Supply Line 32-21 Section 2 Hydrotest Project

B. Maps and Images

Figure 1: Satellite Image of Supply Line 32-21 Sections 1, 2, and 3

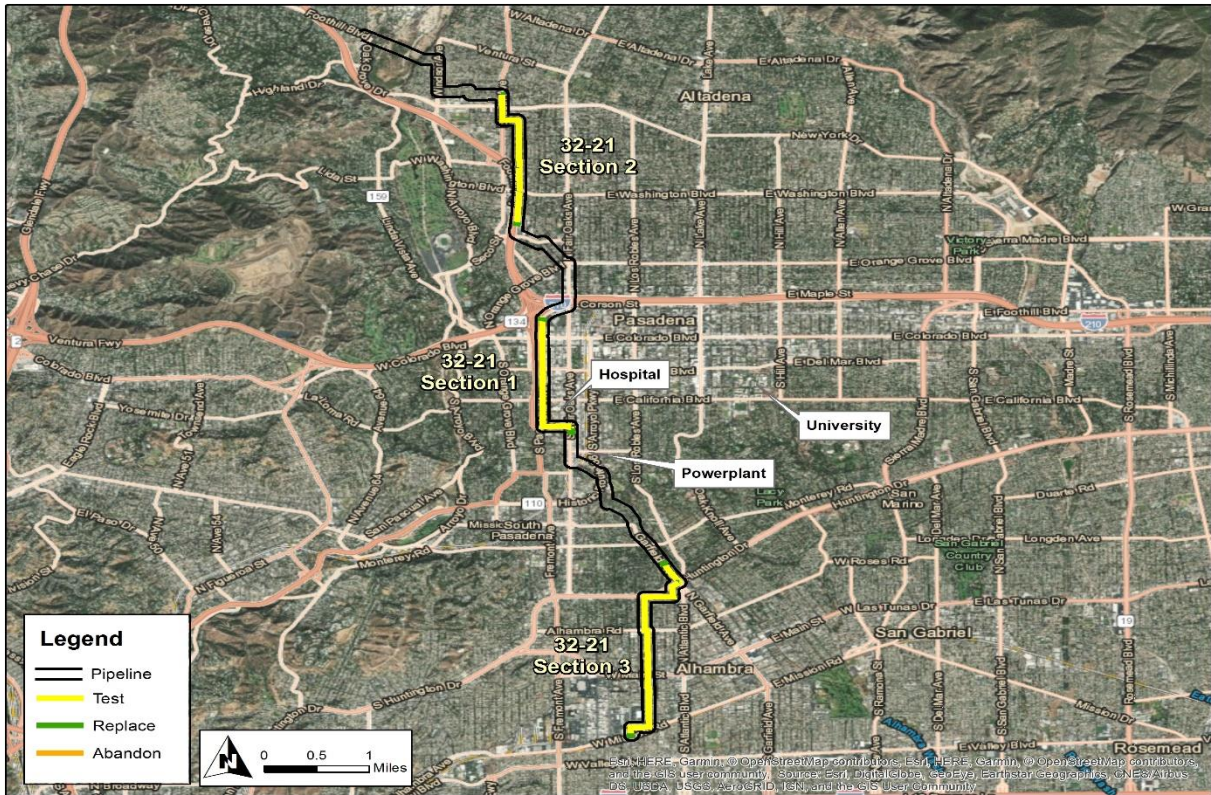

Pipeline Safety Enhancement Plan Final Report Supply Line 32-21 Section 2 Hydrotest Project

Figure 2: Overview Map of Supply Line 32-21 Sections 1, 2, and 3

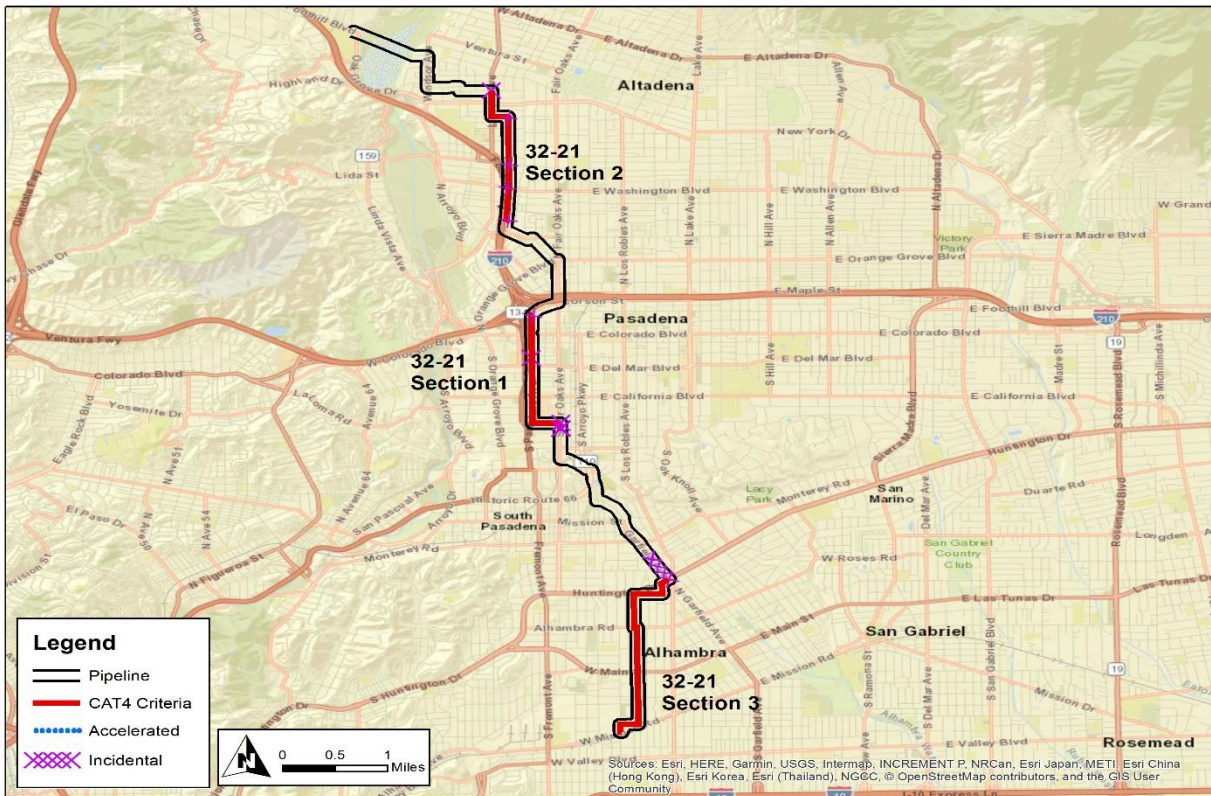

Pipeline Safety Enhancement Plan Final Report Supply Line 32-21 Section 2 Hydrotest Project

Figure 3: Satellite Image of Line 32-21 Section 2 Hydrotest Project

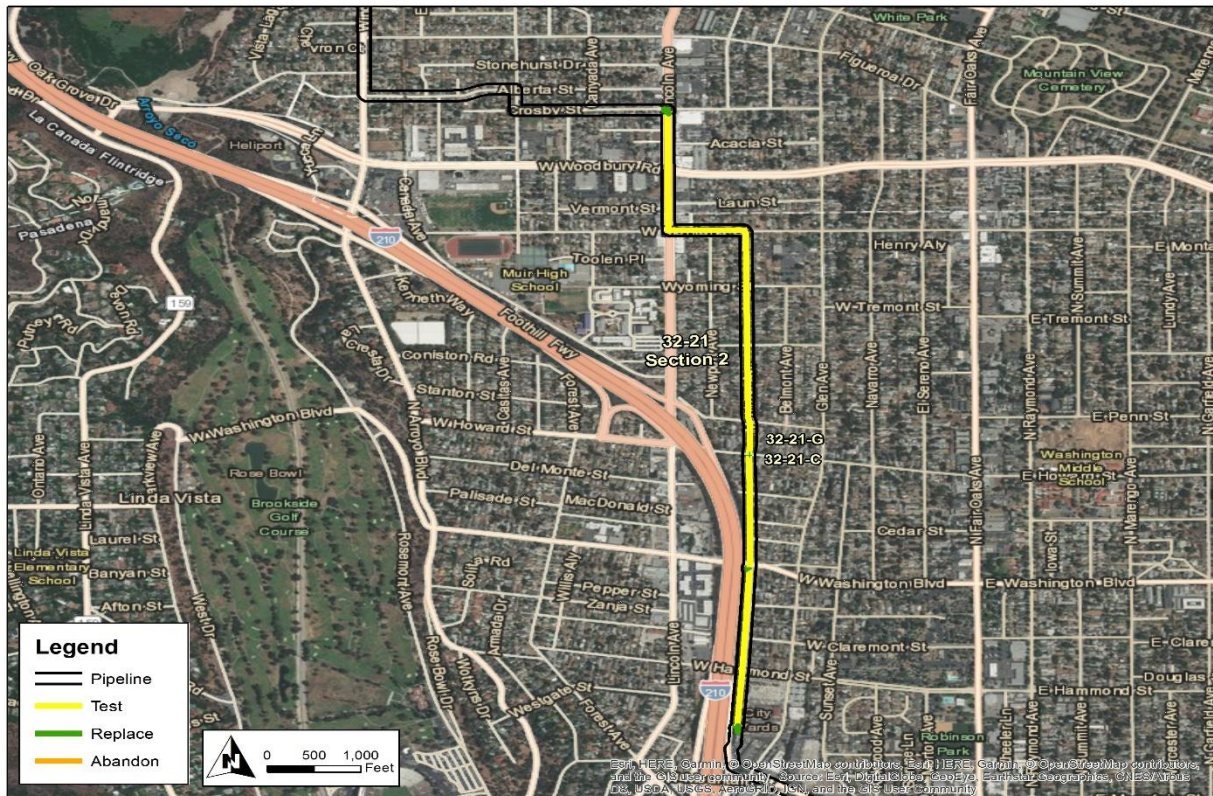

Pipeline Safety Enhancement Plan Final Report Supply Line 32-21 Section 2 Hydrotest Project

Figure 4: Overview Map of Supply Line 32-21 Section 2 Hydrotest Project

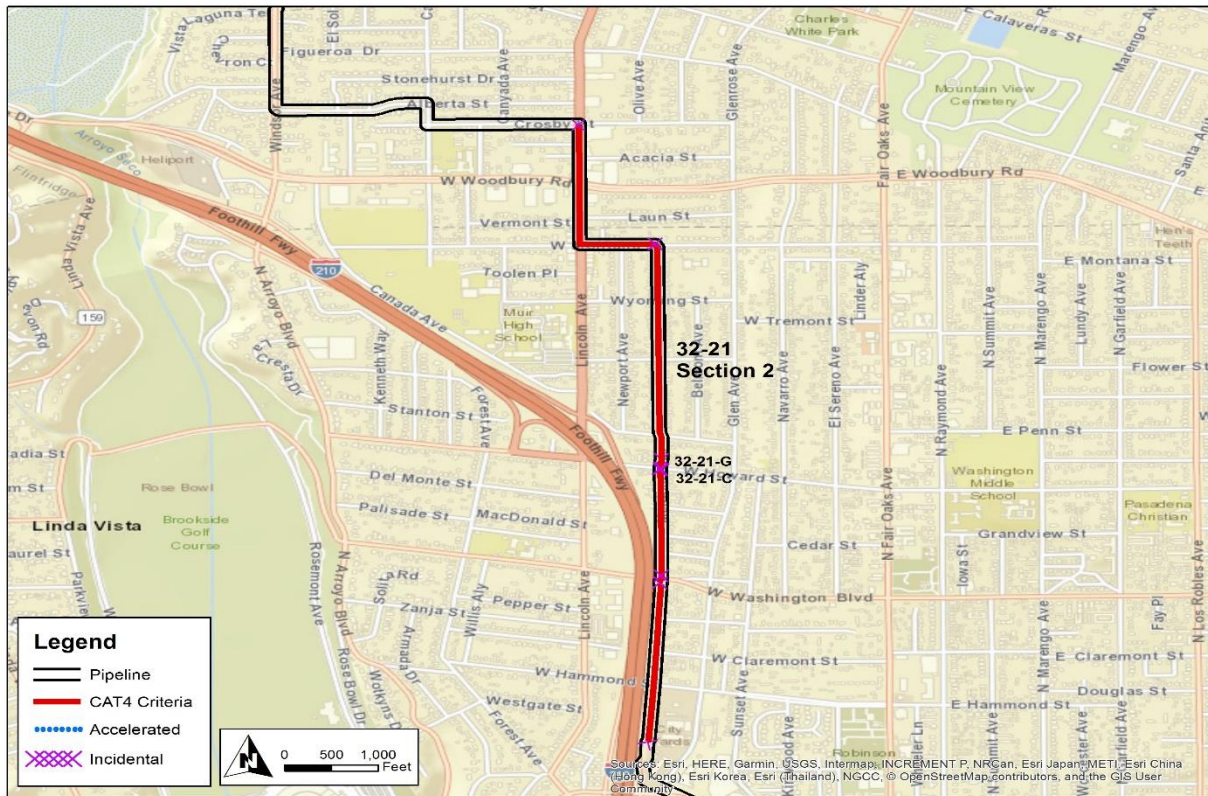

Pipeline Safety Enhancement Plan Final Report
Supply Line 32-21 Section 2 Hydrotest Project

II. ENGINEERING, DESIGN, AND PLANNING

A. Project Scope

Table 2: Mileage Information²

	Criteria	Accelerated	Incidental	Total ³
Final Mileage	1.574 mi.	0 mi.	0.029 mi.	1.602 mi.
	8,311 ft.	0 ft.	152 ft.	8,459 ft.

SoCalGas and SDG&E presented a conceptual project scope in workpapers supporting the 2011 PSEP filing.⁴ Prior to initiating execution of the Project in 2016, SoCalGas and SDG&E reviewed existing pipeline records to validate the scope of the Project. During the Engineering, Design, and Planning phase, SoCalGas and SDG&E further refined the scope. This progression of the project scope is summarized as follows:

1. 2011 PSEP Filing: SoCalGas and SDG&E identified Supply Line 32-21 as a Phase 1A Replacement Project comprised of 8.590 miles of Category 4 Criteria pipe and 1.641 miles of Accelerated pipe.
2. Scope Validation:
 - a. Through scope validation activities, after the 2011 filing and before initiating execution of the Project, SoCalGas and SDG&E successfully reduced the scope of the Project by 3.431 miles of Category 4 Criteria pipe for all Project sections.
 - b. SoCalGas and SDG&E reviewed the MAOP of the pipeline and determined that a derate of the pipeline MAOP would not negatively impact the system. As a result, this pipeline was derated, thus reducing Category 4 Criteria mileage.

² Total mileage of the completed project differs from the mileage of the pipe addressed due to realignment of the pipeline route.

³ Values may not add to total due to rounding.

⁴ See Amended PSEP of SoCalGas and SDG&E, submitted December 2, 2011, in R.11-02-019 and subsequently transferred to A.11-11-002.

Pipeline Safety Enhancement Plan Final Report
Supply Line 32-21 Section 2 Hydrotest Project

3. Engineering, Design, and Constructability:

a. Based on the PSEP Decision Tree, the Project Team initially confirmed the project scope as a replacement project. As the Project Team continued scope development and conducted further analysis, the Project Team determined that the best path forward was to hydrotest.

b. Planned valve replacement included:

- i. Replacing one [REDACTED] mainline valve (MLV) with a new [REDACTED] MLV – for testing purposes;
- ii. Replacing one [REDACTED] valve with a new [REDACTED] valve – for constructability purposes;
- iii. Replacing one [REDACTED] valve with a new [REDACTED] valve – for constructability purposes.

4. Final Project Scope: The final project scope consists of a 1.602 mile hydrotest, pipe and valve replacement, removal of non-piggable features, and permanent abandonment of three taps and valves. There are no Accelerated miles and 0.029 miles of Incidental pipe.

B. Decision Tree Analysis

SoCalGas and SDG&E performed a PSEP Decision Tree analysis of Supply Line 32-21 Section 2 and confirmed the project design should commence as a Hydrotest Project.

For pipeline segments longer than 1,000 feet in length, under the approved PSEP Decision Tree, SoCalGas and SDG&E complete a preliminary review to determine whether SoCalGas and SDG&E can manage customer service impacts if the pipeline segment is taken out of service for a period of two to six weeks to complete pressure testing.

Pipeline Safety Enhancement Plan Final Report
Supply Line 32-21 Section 2 Hydrotest Project

Where mitigation of customer impacts to remove the line from service for pressure testing is feasible, SoCalGas and SDG&E compare the costs, constructability, risks, and benefits of pressure testing and replacement to determine whether pressure testing or replacement is the more prudent option.

As scope development continued, SoCalGas and SDG&E conducted a Test versus Replace (TVR) analysis that analyzed the hydrotest scenario and concluded that Section 2 could be hydrotested in one continuous hydrotest, resulting in manageable disruptions to the community, and that a single hydrotest was the most cost-effective option, thereby changing the recommendation to move forward as a hydrotest project.

Key considerations that support SoCalGas and SDG&E's determination to hydrotest this segment include:

1. Piggable: Non-piggable.
2. Existing Pipe Attributes: The Project Team identified many existing non-piggable pipeline features including a [REDACTED] reducer, pipe segments of varying diameter and a non-piggable MLV.
3. Pipe Vintage: 1948.

C. Engineering, Design, and Planning Factors

SoCalGas and SDG&E reviewed pipeline drawings and other information, contacted internal planning groups, communicated with external stakeholders, conducted survey activities of the area to confirm the presence of underground utilities and substructures, and completed a pre-design site walk.

Pipeline Safety Enhancement Plan Final Report
Supply Line 32-21 Section 2 Hydrotest Project

However, the City of Pasadena would not allow potholing, reducing SoCalGas' and SDG&E's ability to verify underground utilities and substructures. The Project Team did preliminary verification via paint marks and above-ground signs of substructures (i.e. manholes, valve cans, etc.). Key factors that influenced the engineering and design of the Project are as follows:

1. Shut-in Analysis: The Project Team completed a Request for Engineering Review (RER) analysis and concluded that the three regulator stations within the hydrotest segment could be shut-in only during summer conditions without major impacts to the system and customers.
2. Site Observation:
 - a. Due to space limitations within a worksite, the Project Team would need to methodically plan the configuration and placement of water storage tanks, and locations of the test heads.
 - b. The Project Team anticipated a high risk of Polychlorinated Biphenyl (PCB)⁵ contaminated water, as the Supply Line 32-21 Section 1 Project test water tested positive for PCB's.
3. Customer Impact: To avoid major impact to a nearby natural gas vehicle (NGV) station, the Project Team designed a stopple fitting on the tap just north of the station to maintain continuous service.
4. Known Substructures: The City of Pasadena did not allow potholing of its streets or properties. The Project Team did preliminary verification via paint marks and above grade signs of substructures (i.e. manholes, valve cans, etc.).

⁵ PCB is an organic chlorine compound that has been classified as a persistent organic pollutant.

Pipeline Safety Enhancement Plan Final Report Supply Line 32-21 Section 2 Hydrotest Project

5. Permit Conditions: The Project required an encroachment permit from the City of Pasadena. SoCalGas and SDG&E submitted the application in December 2015 and did not receive the permit until May 2016, delaying the start of construction activities until June 2016.
6. Traffic Control: The original plan was to replace the existing [REDACTED] valve offset on Mentone Avenue with a [REDACTED] linear alignment. However, if the offset was not maintained, traffic control would be required within the Caltrans easement. Therefore, the Project Team decided to maintain the offset, and a Caltrans permit was not needed.
7. Valves: SoCalGas and SDG&E identified three valves for relocation or replacement.
8. Taps: The Project Team identified five lateral taps, two for replacement and three for abandonment.

D. Scope Changes

SoCalGas and SDG&E did not make any notable scope changes during detailed design.

Pipeline Safety Enhancement Plan Final Report
Supply Line 32-21 Section 2 Hydrotest Project

III. CONSTRUCTION

A. Construction Contractor Selection

The Project Team prepared an initial cost estimate based on the detailed hydrotest design. Following completion of the engineering, design, and planning activities described above, the Project Team directed the Performance Partner to prepare cost estimates based on a more detailed engineering design package. As indicated above, there were no notable changes in scope between the time when the Project Team prepared the cost estimate and when the Performance Partner prepared and submitted its Target Price Estimate. SoCalGas and SDG&E awarded the construction contract to the Performance Partner.

1. SoCalGas and SDG&E’s Preliminary Construction Cost Estimate (*confidential*):

SoCalGas and SDG&E’s preliminary cost estimate for construction was [REDACTED]

2. Construction Contractor’s Target Price Estimate (*confidential*): The Construction

Contractor’s cost estimate was [REDACTED], which was [REDACTED] than SoCalGas and SDG&E’s preliminary cost estimate for construction.

B. Construction Schedule

Table 3: Construction Timeline

Construction Start Date	06/06/2016
Construction Completion Date	09/30/2016
NOP Date	09/02/2016

C. Changes During Construction

The conditions summarized below were encountered during construction. Activities to address or mitigate these conditions resulted in approximately \$576,000 in change orders.

Pipeline Safety Enhancement Plan Final Report
Supply Line 32-21 Section 2 Hydrotest Project

1. Constructability Issues: The Project Team encountered several constructability issues during construction, as follows:
 - a. The Project Team relocated the branch connection using a reducer to resolve a [REDACTED] valve that was welded too close to the main. In addition, to complete this added scope, the Construction Contractor fabricated two additional isolation caps to facilitate a nitrogen purge prior to tie-in.
 - b. The Construction Contractor found the depth of pipe of the [REDACTED] abandonment to be at approximately 8 feet, and not 3 feet as was assumed.
 - c. The location of a [REDACTED] plug valve was incorrectly identified due to outdated, inaccurate records, and the Construction Contractor conducted extensive potholing to locate the valve during construction.
2. Work Hours: The Project Team extended work hours from 5-8's to 5-10's to minimize schedule delays.
3. Substructures: During excavation activities, the Construction Contractor relocated the south tie-in to avoid substructures and a Caltrans fence that separates the roadway from the 210 Freeway.
4. Gas Handling:
 - a. Additional nitrogen and air compressors were utilized for the initial mainline purge.
 - b. The Performance Partner's estimate assumed a 16 hour tie-in however, the tie-in duration was extended to accommodate relocation of the tie-in to a distance further away from a Southern California Edison line and to install a stopple fitting.

Pipeline Safety Enhancement Plan Final Report
Supply Line 32-21 Section 2 Hydrotest Project

5. Environmental Abatement: Although the Project Team anticipated finding asbestos coating, it also encountered lead painted pipe, coal tar pipe wrap, and excessive coal tar debris/deposits in the excavation trenches running along the pipeline. Construction productivity was reduced as abatement activities were conducted in the trenches.

Pipeline Safety Enhancement Plan Final Report
Supply Line 32-21 Section 2 Hydrotest Project

Figure 5: Installed Test Head Configuration



Pipeline Safety Enhancement Plan Final Report Supply Line 32-21 Section 2 Hydrotest Project

D. Commissioning and Site Restoration

Commissioning activities include restoration of the site, final inspections and placement of the pipeline back into service, transportation and disposal of hydrotested water and hazardous material, and site demobilization. Closeout activities include development of final drawings, finalization of a reconciliation package, and updates to company recordkeeping systems to reflect the completed scope of work.

Pipeline Safety Enhancement Plan Final Report
Supply Line 32-21 Section 2 Hydrotest Project

IV. PROJECT COSTS

A. Cost Avoidance Actions

SoCalGas and SDG&E exercised due diligence in the planning, design, and construction activities for this project to minimize or avoid costs when prudent to do so. As discussed above, the Project Team conducted a site visit to identify and incorporate discernible site conditions into the engineering, design, and planning of the Project. A specific example of cost avoidance actions taken on this Project was the re-use of test heads from another project versus fabricating and testing new test heads that resulted in cost savings on material, labor, and schedule.

B. Cost Estimates

Based on the preliminary design, once the project scope was confirmed and engineering, design, and planning activities were underway, SoCalGas and SDG&E prepared an estimate of the Direct Costs of the Project in the amount of \$5,140,982. This estimate was prepared in May of 2016, using the “SCG Pipeline Estimate Template Rev 3” estimating tool, the most current version of the PSEP Estimate Template at the time. The Project Team considered the conditions known at the time to prepare the preliminary Direct Cost estimate. This estimate reflects the projected Labor, Material, and Services costs anticipated to be incurred to execute the Project.

SoCalGas and SDG&E estimated Indirect Costs of the Project based on the estimated Direct Costs and other project-related variables.

C. Actual Direct and Indirect Costs

Actual Direct Costs reflect the Labor, Material, and Services costs incurred to execute the Project. Actual Indirect Costs reflect costs for incremental overhead loaders in accordance with Company overhead allocation policies. The total loaded cost of Project is \$5,500,364.

Pipeline Safety Enhancement Plan Final Report
Supply Line 32-21 Section 2 Hydrotest Project

Table 4: Estimated and Actual Direct Costs and Variances

Direct Costs (\$)	Estimate	Actuals	Delta Over/(Under)
Company Labor	323,476	246,527	(76,949)
Materials	254,521	201,897	(52,624)
Construction Contractor	1,686,753	2,018,930	332,177
Construction Management & Support	425,660	516,660	91,000
Environmental	317,844	357,102	39,258
Engineering & Design	776,307	890,533	114,226
Project Management & Services	143,369	138,094	(5,275)
ROW & Permits	138,998	169,112	30,114
GMA	1,074,054	575,354	(498,700)
Total Direct Costs	5,140,982	5,114,209	(26,773)

Table 5: Estimated and Actual Indirect Costs, Total Costs, and Variances

Indirect Costs/Total Costs (\$)	Estimate	Actuals	Delta Over/(Under)
Overheads	502,997	384,249	(118,748)
AFUDC	23,691	1,708	(21,983)
Property Taxes	5,205	198	(5,007)
Total Indirect Costs	531,893	386,155	(145,738)
Total Direct Costs	5,140,982	5,114,209	(26,773)
Total Loaded Costs	5,672,875	5,500,364	(172,511)

D. Disallowances

There was no disallowance for Supply Line 32-21 Section 2 as there were no post-1955 segments included in the Project without records that provide the minimum information to demonstrate compliance with then applicable industry standards or regulatory strength testing and recordkeeping requirements.

Pipeline Safety Enhancement Plan Final Report
Supply Line 32-21 Section 2 Hydrotest Project

V. CONCLUSION

SoCalGas and SDG&E enhanced the safety of their integrated natural gas transmission system by prudently executing the Supply Line 32-21 Section 2 Hydrotest Project. Through this Hydrotest Project, SoCalGas and SDG&E successfully hydrotested 1.602 miles of pipe in the City of Pasadena. The Project incurred a total loaded project cost of \$5,500,364.

SoCalGas and SDG&E executed this project prudently through engaging in scope validation efforts that reduced project mileage, coordinating reuse of test heads, and responding to numerous unanticipated field conditions including inaccurate depths and unidentified underground utilities and interferences due to the inability to pothole per the City of Pasadena's policies, and excessive coal tar debris/deposits that needed to be remediated.

SoCalGas and SDG&E engaged in prudent cost avoidance efforts by overall scope validation efforts to reduce Category 4 mileage, ensuring minimal customer and community impacts, and safety testing on a major thoroughfare using a combination of internal and Performance Partner construction management to complete the safety enhancement work as soon as practicable.

End of Supply Line 32-21 Section 2 Hydrotest Project Final Report

Pipeline Safety Enhancement Plan Final Report
Supply Line 32-21 Section 3 Hydrotest Project

I. SUPPLY LINE 32-21 SECTION 3 HYDROTEST PROJECT

A. Background and Summary

Supply Line 32-21 Section 3 is a predominantly [REDACTED] diameter transmission line that runs approximately 2.4 miles through a highly developed and heavily congested corridor in the cities of Alhambra, South Pasadena, and San Marino. The pipeline is primarily routed across a Class 3 location. This report describes the activity associated with the Supply Line 32-21 Section 3 Hydrotest Project, that consists of hydrotesting 2.391 miles of pipeline. In preparation for the hydrotest, the Project Team replaced approximately 14 feet of pipe, a blowdown valve, and installed a mainline valve (MLV). The specific attributes of this Project are detailed in Table 1 below. The total loaded cost of the Project is \$3,857,574.

The Supply Line 32-21 Section 3 Hydrotest Project is a component of Supply Line 32-21, that was identified in the 2011 PSEP filing¹ as a 10.231 mile replacement project. The pipeline traverses the cities of Alhambra, Pasadena, and San Marino. For project manageability purposes and due to unique characteristics related to non-contiguous portions of the pipeline, SoCalGas and SDG&E divided the Supply Line 32-21 filing into three project sections to be executed and managed individually. This report summarizes activity and actual costs related to Section 3 only. Sections 1 and 2 will be reported separately and submitted in the same reasonableness review.

Pipeline Safety Enhancement Plan Final Report Supply Line 32-21 Section 3 Hydrotest Project

Table 1: General Project Information

Project Name	Supply Line 32-21 Section 3		
Project Type	Hydrotest		
Length	2.391 miles		
Location	Alhambra, South Pasadena, and San Marino		
Class	3		
MAOP (<i>confidential</i>)	██████████		
Pipe Vintage	1948		
Construction Start	09/19/2016		
Construction Finish	11/04/2016		
Original Pipe Diameter (<i>confidential</i>)	██████████		
New Diameter (<i>confidential</i>)	N/A		
Original SMYS ¹ (<i>confidential</i>)	██████████		
New SMYS (<i>confidential</i>)	██████████		
Project Costs (\$)	Capital	O&M	Total
Loaded Project Costs	682,696	3,174,878	3,857,574
Disallowed Costs	-	-	-

¹ Highest percentage of Specified Minimum Yield Strength (SMYS) of Category 4 Criteria pipe.

Pipeline Safety Enhancement Plan Final Report
Supply Line 32-21 Section 3 Hydrotest Project

B. Maps and Images

Figure 1: Satellite Image of Supply Line 32-21 Sections 1, 2, and 3



Pipeline Safety Enhancement Plan Final Report Supply Line 32-21 Section 3 Hydrotest Project

Figure 2: Overview Map of Supply Line 32-21 Sections 1, 2, and 3

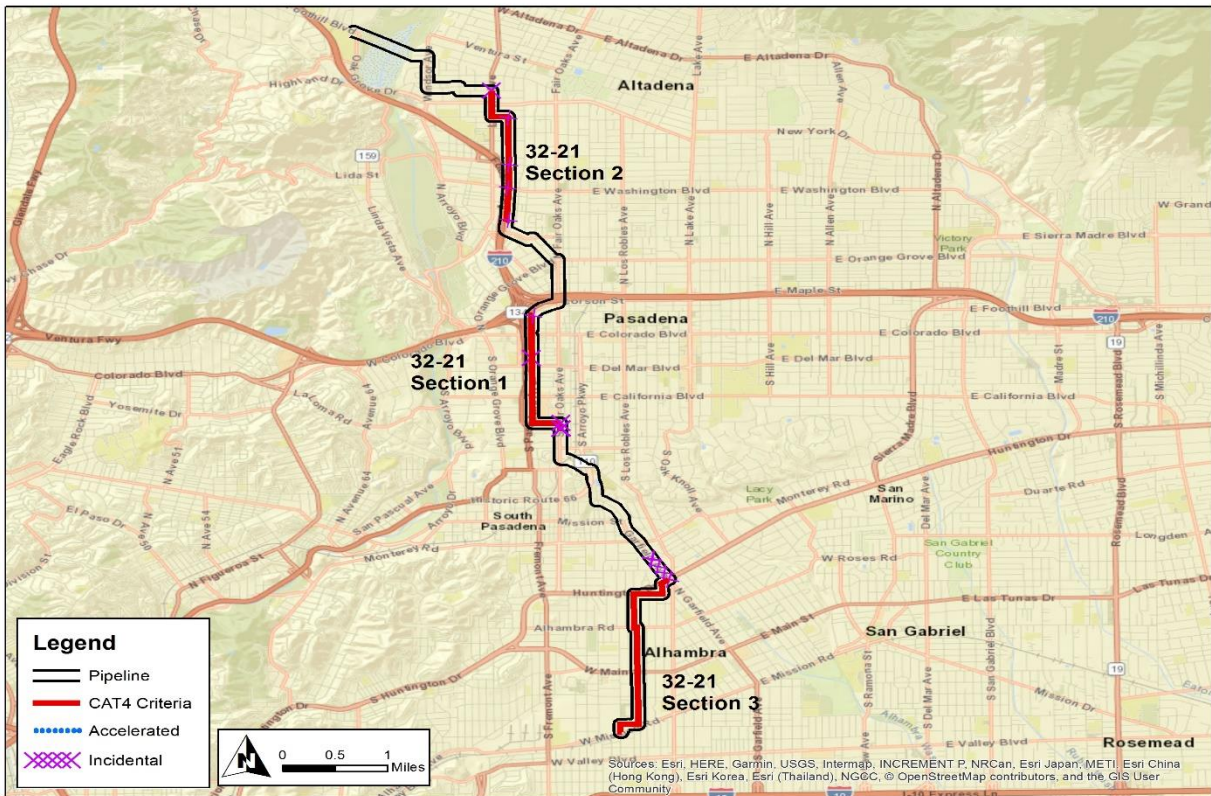

Pipeline Safety Enhancement Plan Final Report Supply Line 32-21 Section 3 Hydrotest Project

Figure 3: Satellite Image of Supply Line 32-21 Section 3 Hydrotest Project

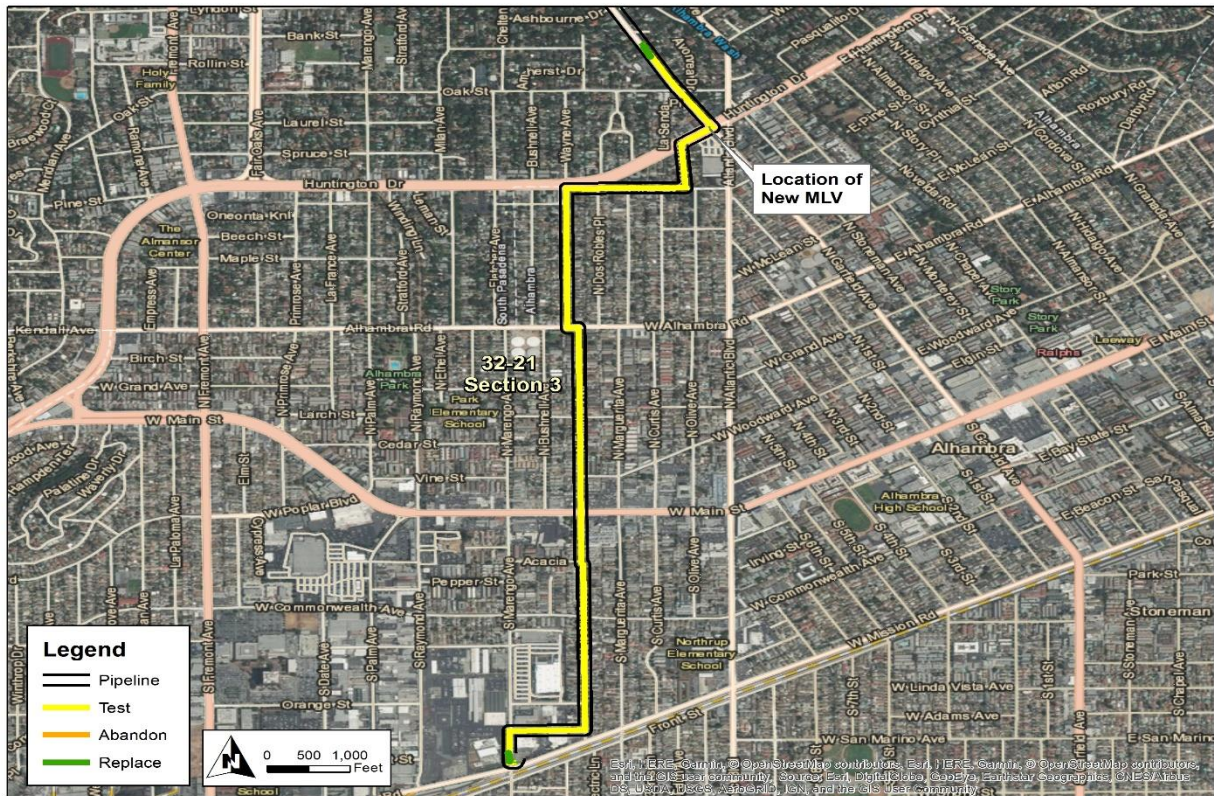

Pipeline Safety Enhancement Plan Final Report Supply Line 32-21 Section 3 Hydrotest Project

Figure 4: Overview Map of Supply Line 32-21 Section 3 Hydrotest Project

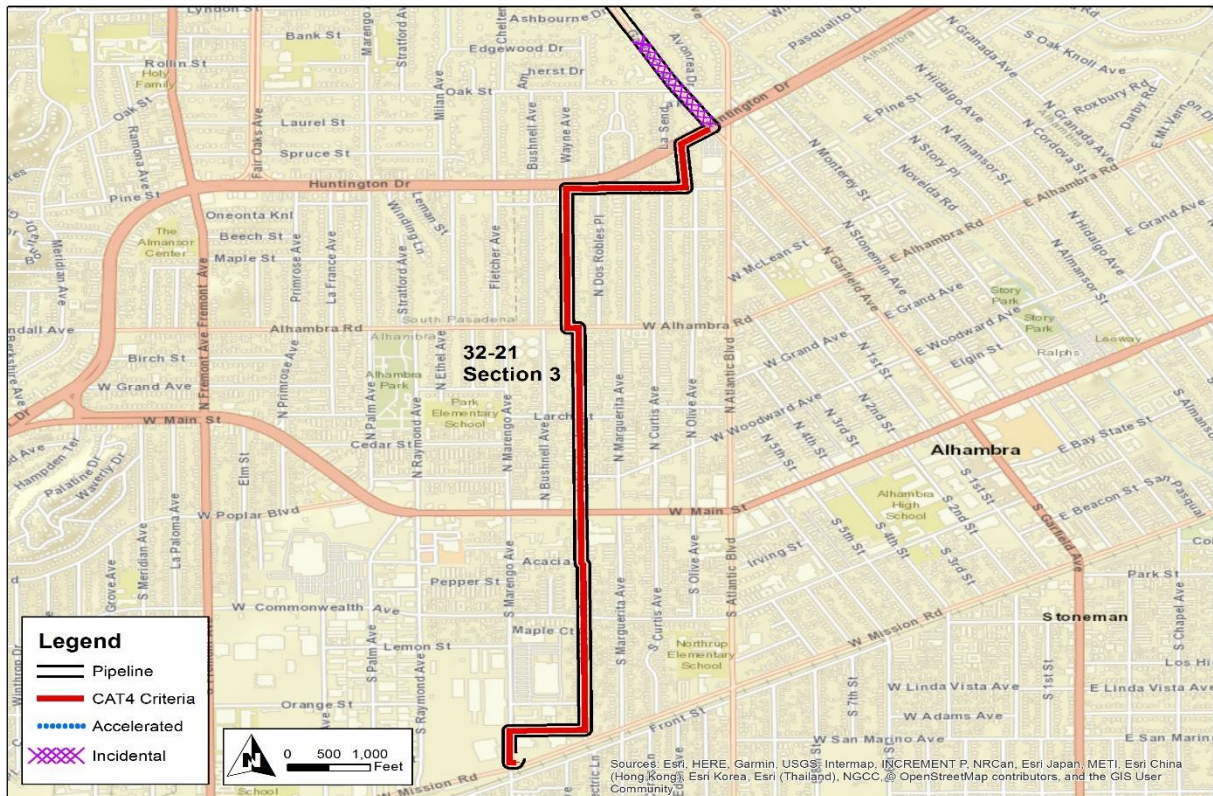

Pipeline Safety Enhancement Plan Final Report
Supply Line 32-21 Section 3 Hydrotest Project

II. ENGINEERING, DESIGN, AND PLANNING

A. Project Scope

Table 2: Mileage Information

	Criteria	Accelerated	Incidental	New	Total ²
Final Mileage	2.112 mi.	0 mi.	0.279 mi.	0.001 mi.	2.391 mi.
	11,152 ft.	0 ft.	1,470 ft.	3 ft.	12,626 ft.

SoCalGas and SDG&E presented a conceptual project scope in workpapers supporting the 2011 PSEP filing.³ Prior to initiating execution of the Project in 2016, SoCalGas and SDG&E reviewed existing pipeline records to validate the scope of the Project. During the Engineering, Design, and Planning phase, SoCalGas and SDG&E further refined the scope. This progression of the project scope is summarized as follows:

1. 2011 PSEP Filing: SoCalGas and SDG&E identified Supply Line 32-21 as a Phase 1A Replacement Project comprised of 8.590 miles of Category 4 Criteria pipe and 1.641 miles of Accelerated pipe.
2. Scope Validation:
 - a. Through scope validation activities, after the 2011 filing and before initiating execution of the Project, SoCalGas and SDG&E successfully reduced the scope of the Project by 3.431 miles of Category 4 Criteria pipe for all Project sections.

² Values may not add to total due to rounding.

³ See Amended PSEP of SoCalGas and SDG&E, submitted December 2, 2011, in R.11-02-019 and subsequently transferred to A.11-11-002.

Pipeline Safety Enhancement Plan Final Report
Supply Line 32-21 Section 3 Hydrotest Project

- b. SoCalGas and SDG&E reviewed the MAOP of the pipeline and determined that a derate of the pipeline MAOP would not negatively impact the system. As a result, this pipeline was derated, thus reducing Category 4 Criteria mileage.
3. Engineering, Design, and Constructability:
 - a. Based on the PSEP Decision Tree, although the Project Team initially determined that the project would be a replacement, after further analysis, confirmed the project scope as a hydrotest project, as the pipeline could be taken out of service with manageable customer impacts.
 - b. The Project Team completed a Test versus Replace estimate and confirmed that a hydrotest was the most cost-effective option if the non-piggable features were removed.
 - c. New mileage is a result of alignment offset.
4. Final Project Scope: The final project scope consists of a 2.391 mile hydrotest and, in preparation for the hydrotest, the Project Team replaced an existing section of [REDACTED] pipe and a valve with new [REDACTED] pipe, blowdown valve replacement, and mainline valve installation. There are no Accelerated miles and 0.279 miles of Incidental pipe.

B. Decision Tree Analysis

SoCalGas and SDG&E performed a PSEP Decision Tree analysis of Supply Line 32-21 Section 3 and initially confirmed the project design should commence as a Replacement Project.

Pipeline Safety Enhancement Plan Final Report
Supply Line 32-21 Section 3 Hydrotest Project

For pipeline segments longer than 1,000 feet in length, under the approved PSEP Decision Tree, SoCalGas and SDG&E complete a preliminary review to determine whether SoCalGas and SDG&E can manage customer service impacts if the pipeline segment is taken out of service for a period of two to six weeks to complete pressure testing. Where mitigation of customer impacts to remove the line from service for pressure testing is feasible, SoCalGas and SDG&E compare the costs, constructability, risks, and benefits of pressure testing and replacement to determine whether pressure testing or replacement is the more prudent option.

As scope development continued, SoCalGas and SDG&E conducted a Test versus Replace (TVR) analysis that analyzed the hydrotest scenario and concluded that Section 3 could be hydrotested in one continuous hydrotest, resulting in manageable disruptions to the community, and that a single hydrotest was the most cost-effective option, thereby changing the recommendation to hydrotest the line.

Key considerations that support SoCalGas and SDG&E's determination to hydrotest this segment include:

1. TVR Scenarios: 1) Test and replace non-piggable features, and 2) Replacement.
2. Piggable: Non-piggable.
3. Pipe Vintage: 1948.
4. Longseam Type: Unknown.
5. Longseam Repair History: No identified issues.
6. Condition of Coating: No identified issues.
7. History of Leaks: No identified issues.

Pipeline Safety Enhancement Plan Final Report
Supply Line 32-21 Section 3 Hydrotest Project

8. Constructability: No In-line Inspection (ILI) information is available as the line is non-piggable, but per the external corrosion direct assessment (ECDA) report from 2009, the current pipe conditions did not pose any threat to the integrity of the pipe.

C. Engineering, Design, and Planning

SoCalGas and SDG&E reviewed pipeline drawings and other information, contacted internal planning groups, communicated with external stakeholders, conducted survey activities, including reviewing public records, ground penetrating radar, and potholing of the area to confirm the presence of underground utilities and substructures, and completed a pre-design site walk. Key factors that influenced the engineering and design of the Project are as follows:

1. Site Observations:
 - a. The Project Team relocated the original site selected for the north test end placing it out of a high-traffic intersection, that in turn, increased the overall Incidental footage.
 - b. The Project Team determined that the pipe location was further away from the curb than was originally identified and revised the traffic control plans prior to construction mobilization.
 - c. The Project Team identified a blowoff valve during planning stages but could not visually verify the valve in the field.
2. Shut-in Analysis: The Project Team completed a Request for Engineering Review (RER) analysis and concluded the line could be shut-in, as long as the Project Team coordinated the outage with a non-core customer.

Pipeline Safety Enhancement Plan Final Report
Supply Line 32-21 Section 3 Hydrotest Project

3. Valves: The Project Team determined that the original [REDACTED] valve would require removal and replacement with a [REDACTED] valve to accommodate the hydrotest.

D. Scope Changes

Through engineering, design, and planning activities, SoCalGas and SDG&E determined that changes in scope were appropriate to enhance the design of the Project and address engineering factors. As a result, the preliminary cost estimate does not fully reflect the final scope. Summarized below are notable changes in scope made after the preliminary cost estimate was developed and approved:

1. The Project design added replacement of a blowoff valve because the existing assembly could not be tested through.
2. As the project plan progressed, the duration of the construction schedule was reduced.

Pipeline Safety Enhancement Plan Final Report
Supply Line 32-21 Section 3 Hydrotest Project

III. CONSTRUCTION

A. Construction Contractor Selection

The Project Team prepared an initial cost estimate based on the preliminary design. Following completion of the engineering, design, and planning activities described above, SoCalGas and SDG&E entered into a competitive bidding process to select a construction contractor, that included the updated design described in the discussion of notable Scope Changes above. SoCalGas and SDG&E awarded the construction contract to the bidder that best met the selection criteria for this project.

1. SoCalGas and SDG&E's Preliminary Construction Cost Estimate (*confidential*): SoCalGas and SDG&E's preliminary cost estimate for construction was [REDACTED].
2. Construction Contractor's Bid (*confidential*): The Construction Contractor's Bid was [REDACTED], which was [REDACTED] than SoCalGas and SDG&E's preliminary cost estimate for construction.

B. Construction Schedule

Table 3: Construction Timeline

Construction Start Date	09/19/2016
Construction Completion Date	11/04/2016
NOP Date	10/25/2016

C. Changes During Construction

SoCalGas and SDG&E successfully mitigated conditions in a manner that minimized potential impacts on project scope, cost and schedule. As a result, these conditions did not result in any notable change orders.

Pipeline Safety Enhancement Plan Final Report
Supply Line 32-21 Section 3 Hydrotest Project

Figure 5: Lowering Top Half of Stopple Fitting at Garfield Avenue



Pipeline Safety Enhancement Plan Final Report
Supply Line 32-21 Section 3 Hydrotest Project

D. Commissioning and Site Restoration

Commissioning activities include restoration of the site, final inspection and placement of the pipeline back into service, transportation and disposal of hydrotested water and hazardous material, and site demobilization. Closeout activities include development of final drawings, finalization of the reconciliation package, and updates to company recordkeeping systems to reflect the completed scope of work.

IV. PROJECT COSTS

A. Cost Avoidance Actions

SoCalGas and SDG&E exercised due diligence in the planning, design, and construction activities for this project to minimize or avoid costs when prudent to do so. As discussed above, the Project Team conducted a site visit to identify and incorporate discernible site conditions into the engineering, design, and planning of the Project. Specific examples of cost avoidance actions taken on this project are:

1. Engineering and Design: At the location of the [REDACTED] valve removal, the Project Team developed a more efficient design, that reduced the excavation size from 45 feet by 14 feet to 20 feet by 8 feet.
2. Materials: The Project Team reused test heads avoiding material, fabrication, and pretesting costs.
3. Permit Conditions: The Project Team negotiated with the city to revise work hours that were less confining at specific work locations different from those that were originally specified by city permits.

B. Cost Estimates

Based on the preliminary design, once the project scope was confirmed and engineering, design, and planning activities were underway, SoCalGas and SDG&E prepared an estimate of the Direct Costs of the Project in the amount of \$4,778,844. This estimate was prepared in June of 2016, using the “SCG Pipeline Estimate Template Rev 3” estimating tool, the most current version of the PSEP Estimate Template at the time. The Project Team considered the conditions known at the time to prepare the preliminary Direct Cost estimate.

Pipeline Safety Enhancement Plan Final Report
Supply Line 32-21 Section 3 Hydrotest Project

This estimate reflects the projected Labor, Material, and Services costs anticipated to be incurred to execute the Project.

SoCalGas and SDG&E estimated Indirect Costs of the Project based on the estimated Direct Costs and other project related variables.

C. Actual Direct and Indirect Costs

Actual Direct Costs reflect the Labor, Material, and Services costs incurred to execute the Project. Actual Indirect Costs reflect costs for incremental overhead loaders in accordance with Company overhead allocation policies. The total loaded cost of the Project is \$3,857,574.

Pipeline Safety Enhancement Plan Final Report
Supply Line 32-21 Section 3 Hydrotest Project

Table 4: Estimated and Actual Direct Costs and Variances

Direct Costs (\$)	Estimate	Actuals	Delta Over/(Under)
Company Labor	367,340	182,543	(184,797)
Materials	151,553	124,689	(26,864)
Construction Contractor	1,611,937	1,159,941	(451,996)
Construction Management & Support	435,559	650,850	215,291
Environmental	404,843	283,266	(121,577)
Engineering & Design	563,769	578,944	15,175
Project Management & Services	202,080	95,527	(106,553)
ROW & Permits	63,195	82,361	19,166
GMA	978,568	404,466	(574,102)
Total Direct Costs	4,778,844	3,562,587	(1,216,257)

Table 5: Estimated and Actual Indirect Costs, Total Costs, and Variances

Indirect Costs/Total Costs (\$)	Estimate	Actuals	Delta Over/(Under)
Overheads	542,147	291,037	(251,110)
AFUDC	58,818	3,496	(55,322)
Property Taxes	13,252	454	(12,798)
Total Indirect Costs	614,217	294,987	(319,230)
Total Direct Costs	4,778,844	3,562,587	(1,216,257)
Total Loaded Costs	5,393,061	3,857,574	(1,535,487)

D. Disallowances

There was no disallowance for the Supply Line 32-21 Section 3 as there were no post-1955 segments included in the Project without records that provide the minimum information to demonstrate compliance with then applicable industry standards or regulatory strength testing and recordkeeping requirements.

Pipeline Safety Enhancement Plan Final Report
Supply Line 32-21 Section 3 Hydrotest Project

V. CONCLUSION

SoCalGas and SDG&E enhanced the safety of their integrated natural gas transmission system by prudently executing the Supply Line 32-21 Section 3 Hydrotest Project.

Through this Hydrotest Project, SoCalGas and SDG&E successfully hydrotested 2.391 miles of pipe, replaced an existing section of [REDACTED] pipe with [REDACTED] pipe, replaced a blowdown valve, and installed a MLV in the City of Alhambra, South Pasadena, and San Marino. The total loaded cost of the Project is \$3,857,574.

SoCalGas and SDG&E executed this Project prudently through engaging in scope validation efforts that reduced project mileage, coordinating reuse of test heads, and responding to numerous unanticipated field conditions including relocation of a test end, unanticipated pipeline repairs, additional requests from the city, and coordination with another local utility.

SoCalGas and SDG&E engaged in prudent cost avoidance efforts by overall scope validation efforts to reduce Category 4 mileage, developing and executing a more efficient design, ensuring minimal customer and community impacts, and planning favorable working hours with the Construction Contractor to complete the safety enhancement work as soon as practicable.

End of Supply Line 32-21 Section 3 Hydrotest Project Final Report

Pipeline Safety Enhancement Plan Final Report
Supply Line 37-18-F Hydrotest Project

I. SUPPLY LINE 37-18-F HYDROTEST PROJECT

A. Background and Summary

Supply Line 37-18-F is a [REDACTED] diameter transmission line located in a heavily populated industrial business area with some areas of residential properties along 190th Street in the City of Torrance and the City of Los Angeles that runs approximately 2 miles from Crenshaw Place in Torrance to South Vermont Avenue in Los Angeles. The pipeline is routed across a Class 3 location. This report describes the activities associated with the Supply Line 37-18-F Hydrotest Project, that consists of the hydrotest of 2.084 miles of pipeline, installation of a new mainline valve (MLV) and a new crossover valve. The specific attributes of this Project are detailed in Table 1 below. The total loaded cost of the Project is \$7,555,929.

The Supply Line 37-18-F Hydrotest Project is a component of the Gardena Bundle that comprise of five PSEP projects. SoCalGas and SDG&E bundled these projects to coordinate schedules and reduce costs for customers by sharing a laydown yard, optimizing the use of construction crews to minimize downtime, and effectively managing the engineering, planning contractor, and company resources. The other PSEP projects in the Gardena Bundle are Supply Line 37-07, Supply Line 30-18, Supply Line 37-18, and Supply Line 37-18-K.

Pipeline Safety Enhancement Plan Final Report
Supply Line 37-18-F Hydrotest Project

Table 1: General Project Information

Project Name	Supply Line 37-18-F		
Project Type	Hydrotest		
Length	2.084 miles		
Location	City of Torrance and City of Los Angeles		
Class	3		
MAOP (<i>confidential</i>)	[REDACTED]		
Pipe Vintage	1946		
Construction Start	08/08/2016		
Construction Finish	10/28/2016		
Original Pipe Diameter (<i>confidential</i>)	[REDACTED]		
New Diameter (<i>confidential</i>)	N/A		
Original SMYS ¹ (<i>confidential</i>)	[REDACTED]		
New SMYS (<i>confidential</i>)	[REDACTED]		
Project Costs (\$)	Capital	O&M	Total
Loaded Project Costs	82,853	7,473,076	7,555,929
Loaded Disallowed Costs	-	-	-

¹ Highest percentage of Specified Minimum Yield Strength (SMYS) of Category 4 Criteria pipe.

Pipeline Safety Enhancement Plan Final Report
Supply Line 37-18-F Hydrotest Project

B. Maps and Images

Figure 1: Overview Map of the Gardena Bundle

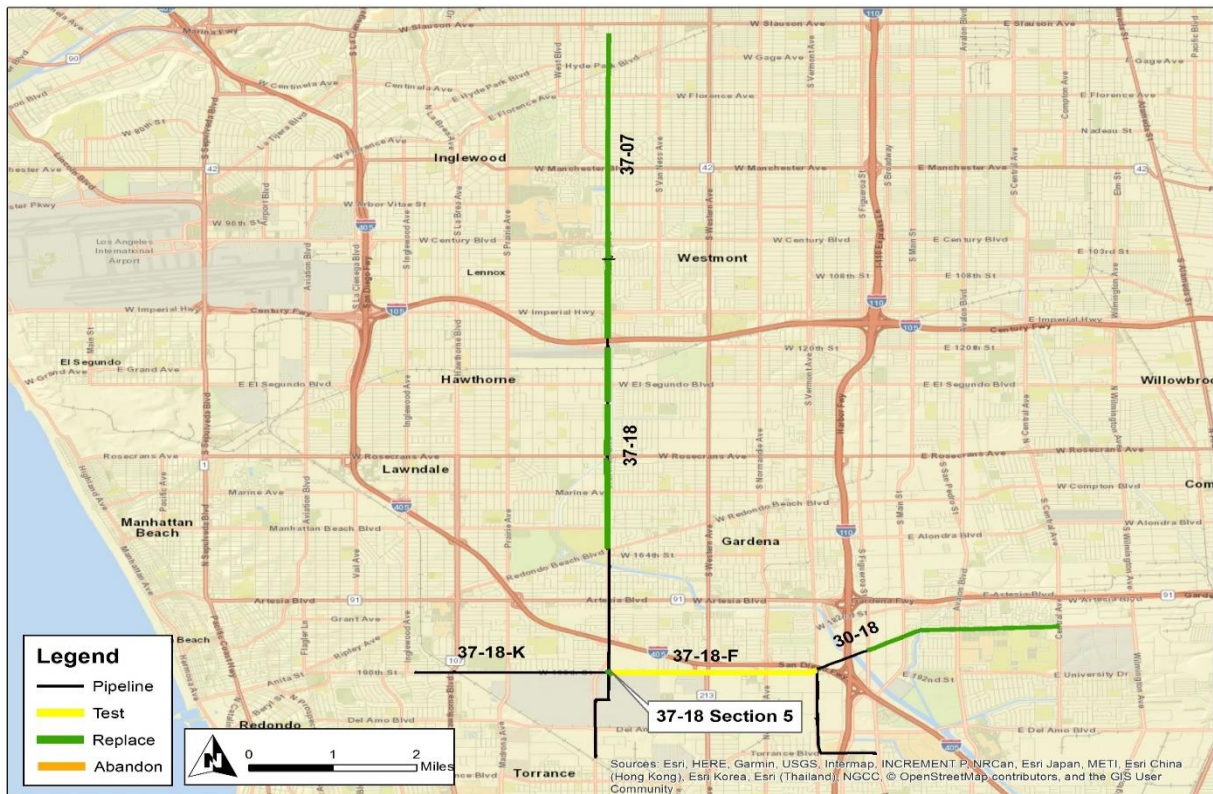

Pipeline Safety Enhancement Plan Final Report Supply Line 37-18-F Hydrotest Project

Figure 3: Overview Map of Supply Line 37-18-F Hydrotest Project

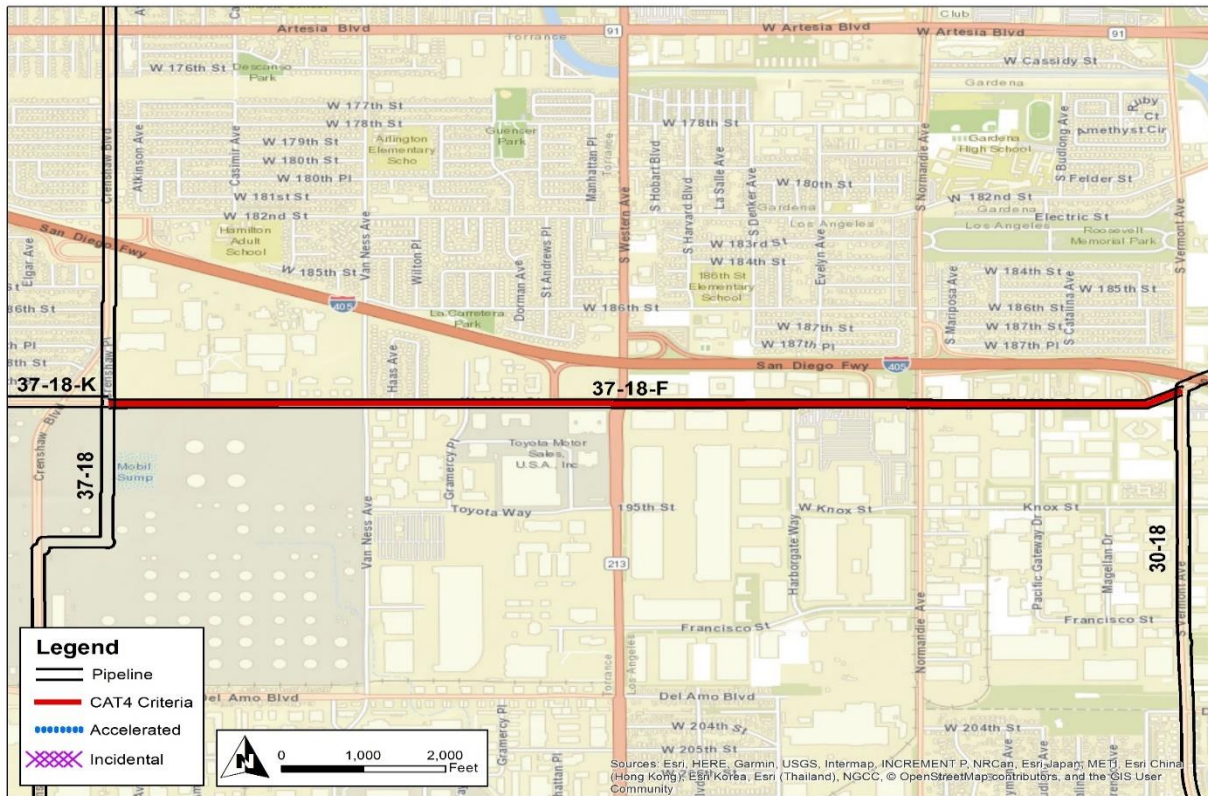

Pipeline Safety Enhancement Plan Final Report Supply Line 37-18-F Hydrotest Project

Figure 4: Schematic of Supply Line 37-18-F West End
(Prior to Supply Line 37-18 Section 5 Replacement Project)

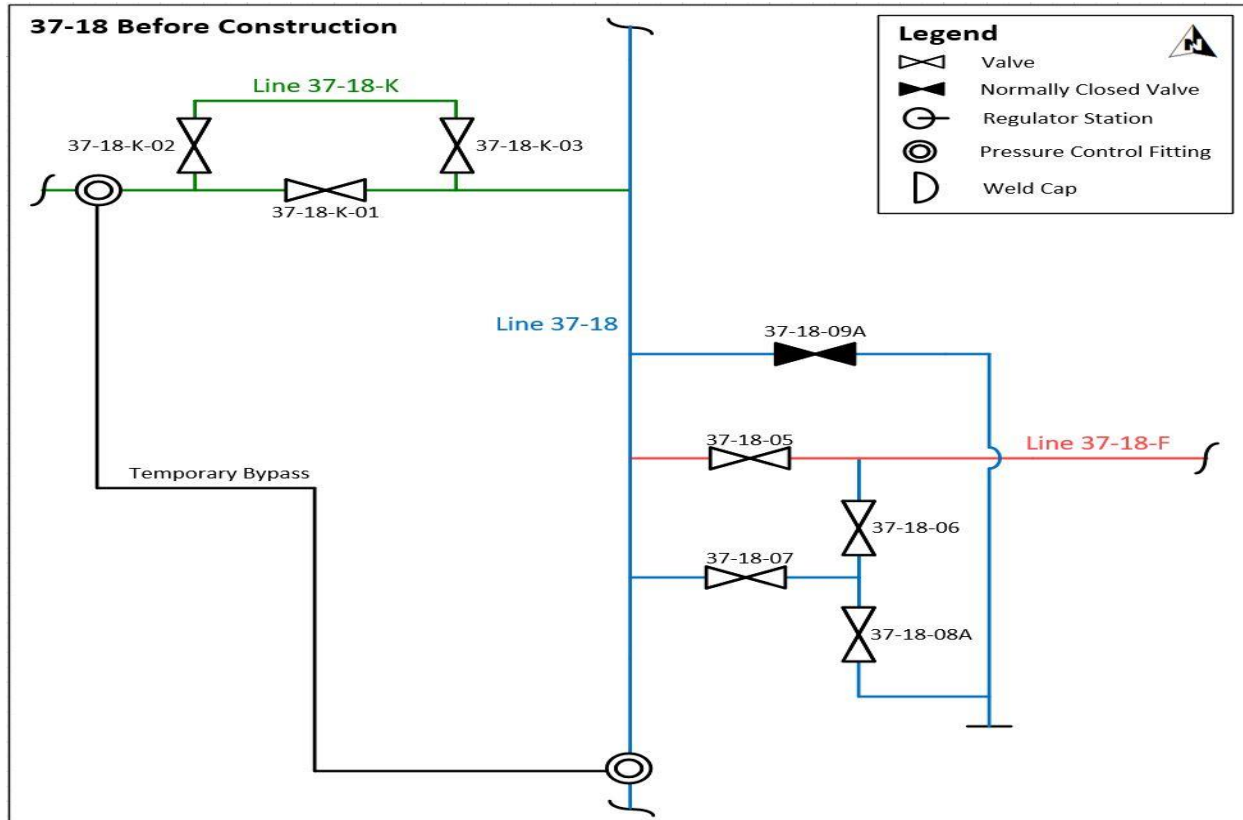

Pipeline Safety Enhancement Plan Final Report Supply Line 37-18-F Hydrotest Project

Figure 5: Schematic of Supply Line 37-18-F – East End
(Prior to Construction of Supply Line 30-18 Section 3 Replacement Project)

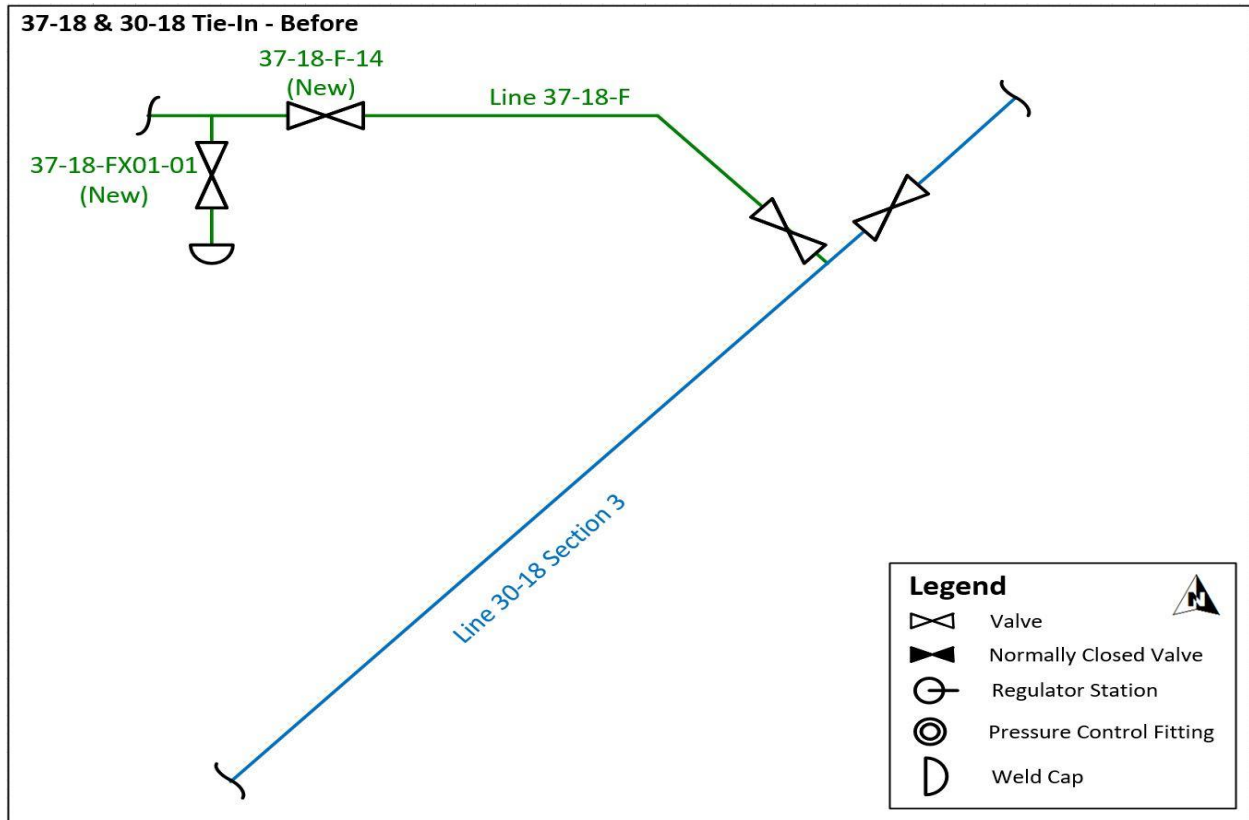

Pipeline Safety Enhancement Plan Final Report
Supply Line 37-18-F Hydrotest Project

II. ENGINEERING, DESIGN, AND PLANNING

A. Project Scope

Table 2: Mileage Information

	Criteria	Accelerated	Incidental	New	Total ²
Final Mileage	2.047 mi.	0 mi.	0.022 mi.	0.014 mi.	2.084 mi.
	10,810 ft.	0 ft.	117 ft.	76 ft.	11,002 ft.

SoCalGas and SDG&E presented a conceptual project scope in workpapers supporting the 2011 PSEP filing.³ Prior to initiating execution of the Project in 2016, SoCalGas and SDG&E reviewed existing pipeline records to validate the scope of the Project. During the Engineering, Design, and Planning phase, SoCalGas and SDG&E further refined the scope. This progression of the project scope is summarized as follows:

1. 2011 PSEP Filing: SoCalGas and SDG&E identified Supply Line 37-18-F as a Phase 1A Replacement Project comprised of 2.057 miles Category 4 Criteria pipe and 0 miles of Accelerated pipe.
2. Scope Validation: Through scope validation activities, after the 2011 filing and before initiating execution of the Project, SoCalGas and SDG&E successfully reduced the scope of the Project by 0.010 miles of Category 4 Criteria pipe.

² Values may not add to total due to rounding.

³ See Amended PSEP of SoCalGas and SDG&E, submitted December 2, 2011, in R.11-02-019 and subsequently transferred to A.11-11-002.

Pipeline Safety Enhancement Plan Final Report
Supply Line 37-18-F Hydrotest Project

3. Engineering, Design, and Constructability:

- a. Due to the complexity of the tie-in designs, the Project Team decided to execute these projects separately and not include the mileage with the Project. During the Design phase, the Project Team coordinated with two adjacent PSEP projects (Supply Line 37-18 Section 5 Replacement and Supply Line 30-18 Section 3 Replacement Project).
- b. By removing this scope, the Project Team deferred execution and replacement of approximately 53 feet of Category 4 Criteria Pipe on 37-18-F to the Supply Line 37-18 Section 5 Replacement Project and the Supply Line 30-18 Section 3 Replacement Project.

4. Final Project Scope: The final project scope consists of a 2.084 mile Hydrotest, installation of one new MLV, and one new crossover valve.

B. Decision Tree Analysis

SoCalGas and SDG&E performed a PSEP Decision Tree analysis of Supply Line 37-18-F and confirmed the project design should commence as a Hydrotest Project.

For pipeline segments longer than 1,000 feet in length, under the approved PSEP Decision Tree, SoCalGas and SDG&E complete a preliminary review to determine whether SoCalGas and SDG&E can manage customer service impacts if the pipeline segment is taken out of service for a period of two to six weeks to complete pressure testing. Where mitigation of customer impacts to remove the line from service for pressure testing is feasible, SoCalGas and SDG&E compare the costs, constructability, risks, and benefits of pressure testing and replacement to determine whether pressure testing or replacement is the more prudent option.

Pipeline Safety Enhancement Plan Final Report
Supply Line 37-18-F Hydrotest Project

Through this Decision Tree analysis, SoCalGas and SDG&E identified pressure testing as the more prudent option. Key considerations that support SoCalGas and SDG&E's determination to pressure test this segment include:

1. Shut-In Analysis: The Project Team completed a Request for Engineering Review (RER) analysis and concluded that the line could be shut-in.
2. Customer Impacts: The RER initially identified a total of 64 customers affected by the Hydrotest Project that required field verification. Upon preliminary review and planning the Project Team determined they could successfully manage customer impact during a shut-in.
3. Community Impacts: The City of Los Angeles required all sidewalk access to remain open and clear during the construction duration.
4. Permit Conditions: No identified issues.
5. Piggability: Non-piggable.
6. Pipe Vintage: 1946.
7. Existing Pipe Attributes: No identified issues.
8. Longseam Type: Unknown.
9. Longseam Repair History: No identified issues.
10. Condition of Coating: No identified issues.
11. History of Leaks: No identified issues.

Pipeline Safety Enhancement Plan Final Report
Supply Line 37-18-F Hydrotest Project

C. Engineering, Design, and Planning Factors

SoCalGas and SDG&E reviewed pipeline drawings and other information, contacted internal planning groups, communicated with external stakeholders, conducted survey activities, including reviewing public records and potholing of the area to confirm the presence of underground utilities and substructures, and completed a pre-design site walk. Key factors that influenced the engineering and design of the Project are as follows:

1. Customer Impacts: Based on the RER, the Project Team determined that the three regulator stations could be shut-in under summer conditions; however, shutting in during the winter would require compressed natural gas (CNG) or liquefied natural gas (LNG) for the three regulator stations. The Project Team further determined that CNG bottles and trucks would be required to feed core customers during the isolation of Supply Line 37-18-F. After field verification, the Project Team identified 13 injection points to feed all affected customers as needed.
2. Community Impacts: The Project Team positioned the east test head in a parking lot due to limitations in the right of way (ROW) work area, and the city requirements to keep the sidewalk open.
3. Land Use: The Project Team utilized the Broadway laydown yard shared with Supply Line 37-18 Sections 2, 3, and 4 and Supply Line 30-18 Section 3 for construction support and material storage. The Project Team required two additional work sites, one at each end of the Supply Line 37-18-F Hydrotest Project for equipment storage during off hours and parking near the Project.

Pipeline Safety Enhancement Plan Final Report
Supply Line 37-18-F Hydrotest Project

The Construction Contractor could mobilize and demobilize equipment to and from the closer work sites without the need to load and unload the equipment for transport to the main laydown yard location. This allowed for more productive construction hours each day due to shorter daily preparation time.

4. Permit Conditions: The Project Team executed multiple revisions of a traffic control plan (TCP) to comply with Caltrans ROW restrictions. The Project Team received the Caltrans permit approval after 19 months from the initial submittal, delaying construction start from 2015 to 2016.
5. Tie-In: As described above, the original tie-in design included the Supply Line 30-18 Section 5 Replacement Project and the Supply Line 30-18 Section 3 Replacement Project with the tie-ins at the ends of Supply Line 37-18-F. This design would replace two 1946 non-piggable MLVs on Supply Line 37-18-F. However, due to system reliability constraints, the Project Team removed the additional replacement projects from the scope of Supply Line 37-18-F Hydrotest Project. The Project Team removed replacement of the valve at the west test end of Supply Line 37-18-F Hydrotest Project and included it with the future Supply Line 37-18 Section 5 Replacement Project⁴. The Project Team included a valve installation at the east tie-in of 37-18-F Hydrotest Project to accommodate isolation required for the Supply Line 30-18 Section 3 Replacement Project including the subsequent removal of the existing valve on Supply Line 37-18-F.
6. Valves: During construction of Supply Line 37-18-F Hydrotest Project, efforts to design Supply Line 30-18 Section 3 Replacement Project were underway.

⁴ Supply Line 37-18 Section 5 Replacement Project will be included for Reasonableness Review in a future filing.

Pipeline Safety Enhancement Plan Final Report
Supply Line 37-18-F Hydrotest Project

The addition of a new tap and valve on Supply Line 37-18-F was needed to maintain feed to customers on Supply Line 30-18 during this future PSEP project. Therefore, the Project Team added a new bridle tap and valve to the east tie-in spool of Supply Line 37-18-F Hydrotest Project during construction. Installing the tap during the tie-in spool construction was lower risk since the line would be out of service during installation.

D. Scope Changes

Through engineering, design, and planning activities, SoCalGas and SDG&E determined that changes in scope were appropriate to enhance the design of the Project and address engineering factors. As a result, the preliminary cost estimate does not fully reflect the final scope. Prior to construction, SoCalGas and SDG&E abandoned or transferred, some of the taps on Supply Line 37-18-F to an adjacent medium pressure line, reducing the number of customer taps and locations that would require CNG or LNG.

Pipeline Safety Enhancement Plan Final Report
Supply Line 37-18-F Hydrotest Project

III. CONSTRUCTION

A. Construction Contractor Selection

The Project Team prepared an initial cost estimate based on the preliminary design. Following completion of the engineering, design, and planning activities described above, the Project Team directed the Performance Partner to prepare cost estimates based on a more detailed engineering design package, that included the updated design as described in the discussion of notable Scope Changes above. SoCalGas and SDG&E awarded the construction contract to the Performance Partner.

1. SoCalGas and SDG&E's Preliminary Construction Cost Estimate (*confidential*):
SoCalGas and SDG&E's preliminary cost estimate for construction was [REDACTED].
2. Construction Contractor's Target Price Estimate (*confidential*): The Construction Contractor's cost estimate was [REDACTED], which was [REDACTED] than SoCalGas and SDG&E's preliminary cost estimate for construction.

B. Construction Schedule

Table 3: Construction Timeline

Construction Start Date	08/08/2016
Construction Completion Date	10/28/2016
NOP Date	10/02/2016

C. Changes During Construction

SoCalGas and SDG&E successfully mitigated conditions during construction in a manner that minimized potential impacts on project scope, cost, and schedule. As a result, these conditions did not result in any notable change orders.

Pipeline Safety Enhancement Plan Final Report
Supply Line 37-18-F Hydrotest Project

Figure 6: East Test Head Location in Parking Lot During Hydrotest



Pipeline Safety Enhancement Plan Final Report
Supply Line 37-18-F Hydrotest Project

Figure 7: Fabrication of Bridle Tap and Valve on East Tie in Spool Added to Design



Pipeline Safety Enhancement Plan Final Report
Supply Line 37-18-F Hydrotest Project

D. Commissioning and Site Restoration

Commissioning activities include restoration of the site, final inspection and placement of the pipeline back into service, transportation and disposal of hydrotested water and hazardous material, and site demobilization. Closeout activities include development of final drawings, finalization of a reconciliation package, and updates to company recordkeeping systems to reflect the completed scope of work.

Pipeline Safety Enhancement Plan Final Report
Supply Line 37-18-F Hydrotest Project

IV. PROJECT COSTS

A. Cost Avoidance Actions

SoCalGas and SDG&E exercised due diligence in the planning, design, and construction activities for this project to minimize or avoid costs when prudent to do so. As discussed above, the Project Team conducted a site visit to identify and incorporate discernible site conditions into the engineering, design, and planning of the Project. Specific examples of cost avoidance actions taken on this project are:

1. Engineering and Design: The Project Team installed a new MLV at the east end of Supply Line 37-18-F that would allow for isolation of Supply Line 37-18-F and removal of existing non-piggable valve during the Supply Line 30-18 Section 3 Replacement Project. The Project Team also installed a new bridle valve on Supply Line 37-18-F at the east tie-in with lower risk while the pipeline was out of service for the hydrotest. This new bridle valve would allow for uninterrupted customer service to Supply Line 30-18, south of the isolation required for Supply Line 30-18 Section 3 Replacement.
2. Planning and Coordination: The Project Team planned and timed the CNG connections to reduce the total impact and amount of CNG required during the shut-in period.
3. Land Use: The Project Team shared the Broadway laydown yard with Supply Line 37-18 Sections 2, 3, 4 and Supply Line 30-18 Section 3, resulting in minimal mobilization and operating costs for the main laydown yard.

Pipeline Safety Enhancement Plan Final Report
Supply Line 37-18-F Hydrotest Project

The Project Team acquired two additional work sites closer to the project site to support on site construction activities. The Project Team was able to limit the time needed for these properties and negotiated favorable pricing. The Project Team stored equipment at these locations overnight, allowing for more productive time during the working hours, with less time spent moving equipment.

B. Cost Estimate

Based on the preliminary design, once the project scope was confirmed and engineering, design, and planning activities were underway, SoCalGas and SDG&E prepared an estimate of the Direct Costs of the Project in the amount of \$10,218,686. This estimate was a revision completed in June of 2016, using the “SCG Pipeline Estimate Template Rev 3” estimating tool, the version of the PSEP Estimate Template at the time. The Project Team considered the conditions known at the time to prepare the preliminary Direct Cost estimate. This estimate reflects the projected Labor, Material, and Services costs anticipated to be incurred to execute the Project.

SoCalGas and SDG&E estimated Indirect Costs of the Project based on the estimated Direct Costs and other project related variables.

C. Actual Direct and Indirect Costs

Actual Direct Costs reflect the Labor, Material and Service costs incurred to execute the Project. Actual Indirect Costs reflect costs for incremental overhead loaders in accordance with Company overhead allocation policies. The total loaded cost of the Project is \$7,555,929.

Pipeline Safety Enhancement Plan Final Report
Supply Line 37-18-F Hydrotest Project

Table 4: Estimated and Actual Direct Costs and Variances

Direct Costs (\$)	Estimate	Actuals	Delta Over/(Under)
Company Labor	548,552	388,468	(160,084)
Materials	683,831	384,732	(299,099)
Construction Contractor	2,544,273	2,039,929	(504,344)
Construction Management & Support	435,559	411,742	(23,817)
Environmental	498,891	325,860	(173,031)
Engineering & Design	1,137,096	1,649,879	512,783
Project Management & Services	2,061,465	802,050	(1,259,415)
ROW & Permits	67,497	123,802	56,305
GMA	2,241,522	792,299	(1,449,223)
Total Direct Costs	10,218,686	6,918,761	(3,299,925)

Table 5: Estimated and Actual Indirect Costs, Total Costs and Variances

Indirect Costs/Total Costs (\$)	Estimate	Actual	Delta Over/(Under)
Overheads	921,639	624,081	(297,558)
AFUDC	-	13,020	13,020
Property Taxes	-	67	67
Total Indirect Costs	921,639	637,168	(284,471)
Total Direct Costs	10,218,686	6,918,761	(3,299,925)
Total Loaded Costs	11,140,325	7,555,929	(3,584,396)

D. Disallowance

There was no disallowance for Supply Line 37-18-F Hydrotest Project as there were no post-1955 segments included in the Project without records that provide the minimum information to demonstrate compliance with then applicable industry standards or regulatory strength testing and recordkeeping requirements.

Pipeline Safety Enhancement Plan Final Report
Supply Line 37-18-F Hydrotest Project

V. CONCLUSION

SoCalGas and SDG&E enhanced the safety of their integrated natural gas transmission system by prudently executing the Supply Line 37-18-F Hydrotest Project. Through this Hydrotest Project, SoCalGas and SDG&E successfully hydrotested 2.084 miles of pipe and installed two valves in the City of Torrance and the City of Los Angeles. The total loaded cost of the Project is \$7,555,929.

SoCalGas and SDG&E executed this project prudently by coordinating logistics with the other Gardena Bundle projects to maximize the flexibility and efficiencies of the construction crews. Through careful and thoughtful design, efficiencies were gained through: reducing community impacts by setting the test end in a parking lot, postponing and combining a short segment of Criteria pipe on Supply Line 37-18-F into an adjacent PSEP project, installation of a valve at the east tie-in supporting the future Replacement Project on Supply Line 30-18, and use of multiple laydown yards to improve productivity.

SoCalGas and SDG&E engaged in prudent cost avoidance efforts by verifying the number of taps on the line requiring CNG or LNG; installing a bridle that would reduce construction costs for a future PSEP project; sharing laydown yards with adjacent projects, and acquiring additional laydown yards to allow for more efficient construction activities.

End of Supply Line 37-18-F Hydrotest Project Final Report

Pipeline Safety Enhancement Plan Final Report
Supply Line 49-11 Hydrotest Project

I. SUPPLY LINE 49-11 HYDROTEST PROJECT

A. Background and Summary

Supply Line 49-11 is a [REDACTED] diameter transmission line in a highly developed and heavily populated area, crossing under Highway 163, and is adjacent to a large shopping mall that runs approximately 5 miles from Mission Regulator Station ending at the Supply Line 49-28 and Supply Line 49-32 interconnecting near Interstate 5. The pipeline is primarily routed across a Class 3 location. This report describes the activities associated with Supply Line 49-11 Hydrotest Project, that includes a hydrotest of 0.960 miles of pipeline to address 0.192 miles of Criteria pipe, the replacement of 294 feet of pipeline between the tie-in end and a mainline valve replacement, the removal of a pressure control fitting (PCF), and the replacement and relocation of a short section of pipe. The specific attributes of this Project are detailed in Table 1 below. The total loaded cost of the Project is \$7,374,276.

The Supply Line 49-11 Hydrotest Project underwent numerous scope changes throughout the Engineering, Design, and Planning process due to ongoing inspection work performed by SoCalGas and SDG&E Pipeline Integrity to validate several features along Supply Line 49-11 and coordination with a local highway improvement project resulting in additional capital costs to reroute a small portion of the existing pipeline.

Pipeline Safety Enhancement Plan Final Report
Supply Line 49-11 Hydrotest Project

Table 1: General Project Information

Project Name	Supply Line 49-11		
Project Type	Hydrotest		
Length	0.960 miles		
Location	City of San Diego		
Class	3		
MAOP (<i>confidential</i>)	[REDACTED]		
Pipe Vintage	1969		
Construction Start	06/01/2015		
Construction Finish	04/08/2016		
Original Pipe Diameter (<i>confidential</i>)	[REDACTED]		
New Diameter (<i>confidential</i>)	N/A		
Original SMYS ¹ (<i>confidential</i>)	[REDACTED]		
New SMYS (<i>confidential</i>)	N/A		
Project Costs (\$)	Capital	O&M	Total
Loaded Project Costs	4,761,550	2,612,726	7,374,276
Disallowed Costs	-	490,530	490,530

¹ Highest percentage of Specified Minimum Yield Strength (SMYS) of Category 4 Criteria pipe.

Pipeline Safety Enhancement Plan Final Report Supply Line 49-11 Hydrotest Project

Figure 2: Overview Map of Supply Line 49-11 Hydrotest Project

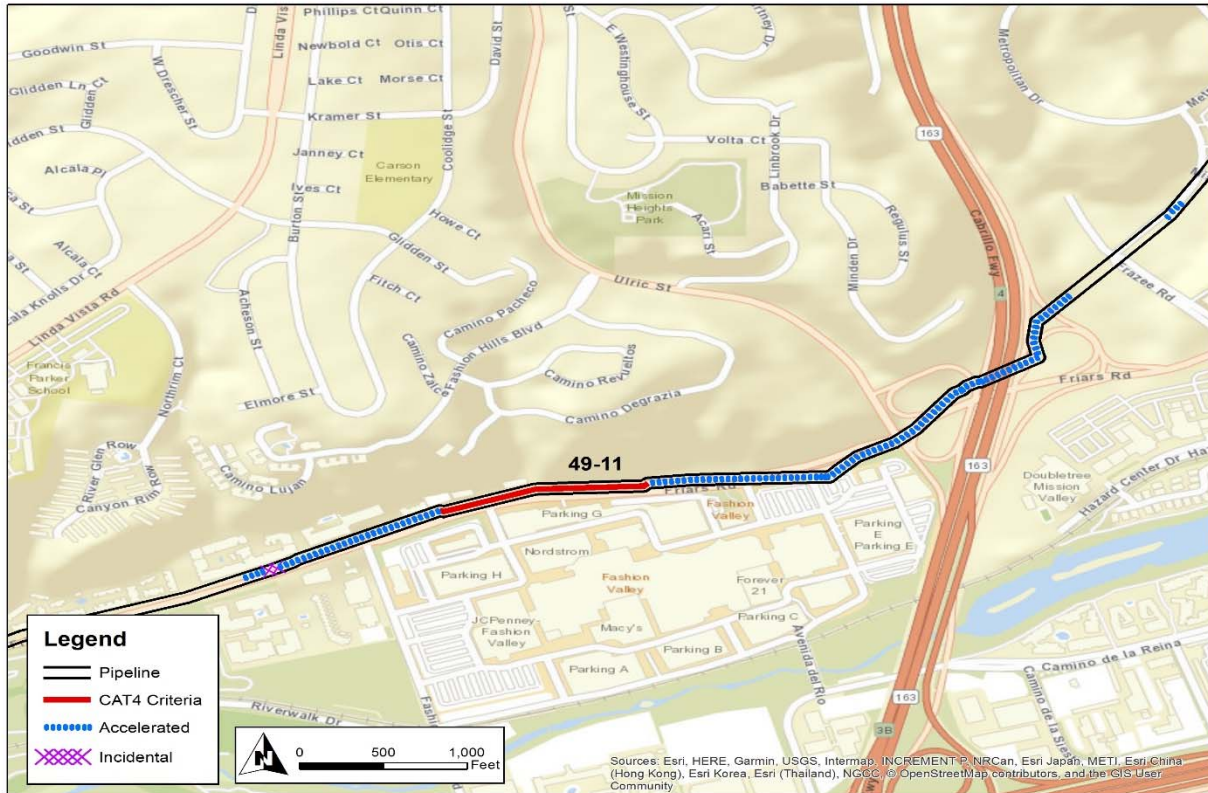

Pipeline Safety Enhancement Plan Final Report
Supply Line 49-11 Hydrotest Project

II. ENGINEERING, DESIGN, AND PLANNING

A. Project Scope

Table 2: Mileage Information

	Criteria	Accelerated ²	Incidental	New	Total ³
Final Mileage	0.165 mi.	0.773 mi.	0.002 mi.	0.021 mi	0.960 mi.
	871 ft.	4079 ft.	10 ft.	109 ft.	5,068 ft.

SoCalGas and SDG&E presented a conceptual project scope in workpapers supporting the 2011 PSEP filing.⁴ Prior to initiating execution of the Project in 2015, SoCalGas and SDG&E reviewed existing pipeline records to validate the scope of the Project. During the Engineering, Design, and Planning phase, SoCalGas and SDG&E further refined the scope. This progression of the project scope is summarized as follows:

1. 2011 PSEP Filing: SoCalGas and SDG&E identified Supply Line 49-11 as a Phase 1A Replacement Project comprised of 0.344 miles of Category 4 Criteria pipe.
2. Scope Validation: Through scope validation activities, after the 2011 filing and before initiating execution of the Project, SoCalGas and SDG&E successfully reduced the scope of the Project by 0.152 miles of Category 4 Criteria pipe.
3. Engineering, Design, and Constructability: During the design phase, the Project Team initiated the Project as a hydrotest recommending two separate tests.

² Accelerated mileage includes Phase 2B pipe. Phase 2B includes pipelines with record of a pressure test, but without record of a pressure test to modern – Subpart J – standards (Phase 2B). The Accelerated mileage was included to realize efficiencies and to enhance project constructability.

³ Values may not add to total due to rounding.

⁴ See Amended PSEP of SoCalGas and SDG&E, submitted December 2, 2011, in R.11-02-019 and subsequently transferred to A.11-11-002.

Pipeline Safety Enhancement Plan Final Report
Supply Line 49-11 Hydrotest Project

Subsequently, during the design efforts the Project Team changed the recommendation to replacement based on information provided by Pipeline Integrity, which limited options for hydrotesting and to meet the planned schedule of a future highway improvement project. However, after additional inspection of the pipeline, the Project Team ultimately determined that the Project could proceed as a Hydrotest. The Project Team revised the project scope to a Hydrotest Project with a single test and a short relocation to mitigate a conflict with a highway widening project.

- a. Accelerated mileage was added to the Hydrotest scope to extend the test end to the east to test through the Criteria segment that was located beneath Highway 163. Additional footage between segments allowed for a single hydrotest. The Project Team extended the test to the west to replace a non-piggable plug valve.
 - b. The Project Team replaced and relocated the alignment of a 266 foot segment of pipe to address a 27 foot Category 4 segment and replaced an unknown radius elbow. The new alignment addressed the conflict with a future city project.
4. Final Project Scope: The final project scope consists of a 0.960 mile Hydrotest. The Accelerated mileage consists of 0.773 miles of Phase 2B pipe and 10 feet of Incidental pipe.

B. Decision Tree Analysis

SoCalGas and SDG&E performed a PSEP Decision Tree analysis of Supply Line 49-11 and confirmed the project design should commence as a Hydrotest Project.

Pipeline Safety Enhancement Plan Final Report
Supply Line 49-11 Hydrotest Project

For pipeline segments longer than 1,000 feet in length, under the approved PSEP Decision Tree, SoCalGas and SDG&E complete a preliminary review to determine whether SoCalGas and SDG&E can manage customer service impacts if the pipeline segment is taken out of service for a period of two to six weeks to complete pressure testing. Where mitigation of customer impacts to remove the line from service for pressure testing is feasible, SoCalGas and SDG&E compare the costs, constructability, risks, and benefits of pressure testing and replacement to determine whether pressure testing or replacement is the more prudent option.

Through this Decision Tree analysis, SoCalGas and SDG&E identified hydrotest as the more prudent option. Key considerations that support SoCalGas and SDG&E's determination to hydrotest this segment include:

1. Shut-In Analysis: The Project Team completed a Request for Engineering Review (RER) analysis and concluded that this segment of the line could be shut-in. The Project Team would need to feed two regulator stations through alternative means to maintain customer feed during the shut in.
2. Community Impacts: The Project is located adjacent to a large mall and construction activities may cause major traffic delays in these areas.
3. Permit Conditions: The Project Team did not identify major permitting concerns during this analysis.
4. Piggability: Non-piggable.
5. Existing Attributes: Pipeline piggability was limited because of a series of unknown radius elbows, a non-piggable plug valve, and a PCFs.
6. Pipe Vintage: 1969.

Pipeline Safety Enhancement Plan Final Report
Supply Line 49-11 Hydrotest Project

7. Long Seam Type: Unknown.
8. Long Seam Repair History: No identified issues.
9. Condition of Coating: No identified issues
10. History of Leaks: No identified issues.

C. Engineering, Design, and Planning Factors

As discussed above, the Project Team revised the scope of the Supply Line 49-11 Project due to various factors. The below details the progression of the scope as well as the factors encountered that drove the changes.

SoCalGas and SDG&E reviewed pipeline drawings and other information, contacted internal planning groups, communicated with external stakeholders, conducted survey activities, including reviewing public records and potholing of the area to confirm the presence of underground utilities and substructures, and completed a pre-design site walk. Key factors that influenced the engineering and design of the Hydrotest Project are as follows:

1. Shut-In Analysis: As discussed above, the Project Team completed an RER analysis that concluded the line could not be shut in, unless regulator stations (Regulator Station 1277 and Regulator Station 1059) were fed through alternative means.
2. Customer Impact: The Project Team initially planned for two separate tests because the two regulator stations within the test section could not be isolated without customer impact.

Pipeline Safety Enhancement Plan Final Report
Supply Line 49-11 Hydrotest Project

3. Permit Conditions: The City of San Diego requested that this Project be coordinated with a planned highway improvement project to minimize construction impacts to the community. No detailed plans were available at the time of initial planning.
4. Site Observations: The Project Team located an existing stopple within Caltrans right of way (ROW). The team identified a second stopple located outside of Caltrans ROW and planned to use it during shut-ins.

The Project Team met with other agencies to coordinate the planned utility work to accommodate the future highway widening project. Plans for the highway widening project showed a direct conflict with the location of existing Regulator Station 1277. Road widening plans along Friars Road also showed conflict with the existing location of Supply Line 49-11. As a result, the Project Team determined that a hydrotest was not compatible with the planned highway and road widening projects and proceeded to re-design the Project as a Replacement Project. Additional factors that influenced the engineering and design of the Replacement Project are as follows:

- 1 Other Identified Risks: SoCalGas and SDG&E reviewed the In-Line Inspection report (ILI) from 2013 and identified areas of concern that would limit a pressure test of the line. The Project Team could not immediately validate these areas through direct assessment due to proximity to Highway 163 requiring a Caltrans permit for excavation.
- 2 Schedule Coordination: In order to meet the timeframe and schedule to coordinate with the other utilities for the highway widening project, the Project Team could not wait for final results from the ILI validation that would determine if a hydrotest was feasible. They therefore proceeded with planning for a Replacement Project.
- 3 Constructability: Crossing under Highway 163 required a horizontal directional drill (HDD) and a reroute to avoid major arterial streets.

Pipeline Safety Enhancement Plan Final Report
Supply Line 49-11 Hydrotest Project

During the replacement design efforts, SoCalGas and SDG&E received information from Pipeline Integrity from excavations performed near Highway 163. This assessment of the pipeline by Pipeline Integrity revealed the pipeline condition within acceptable tolerances for a hydrotest. The significant cost savings of hydrotesting this Project drove the Project Team to revise the project scope to a hydrotest.

The final scope included: hydrotest of Criteria pipe, modifications to the line to enhance piggability and retirement of portions of the system in conflict with a future infrastructure project.

1. Customer Impact: The Project Team initially planned for two separate tests because the two regulator stations within the test section could not be isolated without customer impact. However, replacement of Regulator Station 1277 with a short segment of pipe resolved future conflict with the highway widening project and allowed for replacement and testing of all sections in a single test.
2. Bypass: The Project Team could isolate Regulator Station 1059 from the test section to avoid customer impacts by installing a permanent small diameter bypass from the other side of a nearby valve. This enhanced the system by adding a bridle for use during future shut-ins, utilizing the adjacent mainline valve (MLV).
3. Taps: The new bypass to Regulator Station 1059 required the addition of one high pressure tap.
4. Reroute: SoCalGas and SDG&E's coordination efforts with the planned city and highway improvements resulted in rerouting a short portion of the line containing Category 4 Criteria mileage, adding some capital costs to this hydrotest project. The existing section of Supply Line 49-11 would have conflicted with a future planned municipal project and would have needed to be relocated at a future time.

Pipeline Safety Enhancement Plan Final Report
Supply Line 49-11 Hydrotest Project

5. Land Use: This Project shared the Riverwalk laydown yard with other PSEP projects to reduce costs. Additionally, the Project utilized the mall parking lot as a laydown area and workspace.
6. Environmental: The Project was included in the Storm Water Pollution Prevention Plan (SWPPP) permit common to all San Diego projects. The Project followed the procedure for water discharge agreed upon with the city.
7. Valves: A non-piggable plug valve was replaced at Friars Road to enhance piggability.

D. Scope Changes

Through engineering, design, and planning activities, SoCalGas and SDG&E determined that changes in scope were appropriate to enhance the design of the Project and address engineering factors. As a result, the preliminary cost estimate does not fully reflect the final scope. As discussed in Engineering, Design, and Planning, the Project initially began execution as a Hydrotest Project and was revised to a Replacement Project. Execution of design for a Replacement commenced, and the Project Team developed and approved a preliminary cost estimate. As discussed previously the Project was then redesigned as a Hydrotest. The Project Team developed and approved a new estimate for the Hydrotest direct costs. All costs presented throughout are reflective of the Hydrotest project scope.

Pipeline Safety Enhancement Plan Final Report
Supply Line 49-11 Hydrotest Project

III. CONSTRUCTION

A. Construction Contractor Selection

The Project Team prepared an initial cost estimate based on the preliminary Replacement design. As indicated above, a revised estimate was completed to match with the Hydrotest project scope. Following completion of the engineering, design, and planning activities described above, the Project Team directed the Performance Partner to prepare cost estimates based on a more detailed engineering design package that included the updated design described in the discussion on notable Scope Changes. SoCalGas and SDG&E awarded the construction contract to the Performance Partner.

1. SoCalGas and SDG&E’s Preliminary Construction Cost Estimate (confidential):

SoCalGas and SDG&E’s preliminary cost estimate for construction was [REDACTED].

2. Construction Contractor’s Target Price Estimate (confidential): The Construction

Contractor’s cost estimate was [REDACTED], which was [REDACTED] than SoCalGas and SDG&E’s preliminary cost estimate for construction.

B. Construction Schedule

Table 3: Construction Timeline

Construction Start Date	06/01/2015
Construction Completion Date	04/08/2016
NOP Date	11/24/2015

Pipeline Safety Enhancement Plan Final Report
Supply Line 49-11 Hydrotest Project

C. Changes During Construction

The conditions summarized below were encountered during construction. Activities to address or mitigate these conditions resulted in approximately \$600,000 in change orders.

1. Substructures: The Construction Contractor encountered ground water at a depth of eight feet while excavating a replacement section. The Project Team determined the water was coming from a preexisting water main leaking prior to construction. San Diego County Water Authority and City of San Diego made the repair and the ground water was controlled within three weeks from being encountered.
2. Schedule Delays: SoCalGas and SDG&E were unable to complete construction and site restoration before the City of San Diego's holiday construction moratorium. The Project Team completed sufficient field work that allowed the line to be put in service before the moratorium. The Project Team installed steel plates over the trench during the moratorium. The Project Team completed site restoration after completing construction activities following the moratorium.
3. Field Design Changes: The PCF that the Project Team planned to use for isolation did not completely seal. This resulted in an increased duration for the isolation of the line. The Project Team utilized a different valve for isolation. As a result, the removal of the non-sealing PCF was added to the project scope, and the Project Team removed and replaced it with pipe after the hydrotest was completed.
4. Water Quality: SoCalGas and SDG&E reused recycled water from another SoCalGas and SDG&E project. The test used approximately 80,000 gallons.

Pipeline Safety Enhancement Plan Final Report
Supply Line 49-11 Hydrotest Project

D. Commissioning and Site Restoration

Commissioning activities include restoration of the site, final inspection and placement of the pipeline back into service, transportation and disposal of hydrotested water and hazardous material, and site demobilization. Closeout activities include development of final drawings, finalization of a reconciliation package, and updates to company recordkeeping systems to reflect the completed scope of work.

Pipeline Safety Enhancement Plan Final Report
Supply Line 49-11 Hydrotest Project

IV. PROJECT COSTS

A. Cost Avoidance Actions

SoCalGas and SDG&E exercised due diligence in the planning, design, and construction activities for this project to minimize or avoid costs when prudent to do so. As discussed above, the Project Team conducted a site visit to identify and incorporate discernible site conditions into the engineering, design, and planning of the Project. Specific examples of cost avoidance actions taken on this Project are:

1. Engineering and Design: A new bypass installed on Supply Line 49-11 increased system reliability and reduced customer impacts, eliminating the need for customer feed through more costly alternatives.
2. Scope Change: Final validation identified the capability to hydrotest the existing pipeline, avoiding the higher cost of replacement.
3. Future Maintenance: Removal of Regulator Station 1277 reduced future maintenance and operating costs for the distribution system and allowed for performance of a single hydrotest.
4. Land Use: The Project Team negotiated a favorable lease rate with the City of San Diego and shared the laydown yard with other PSEP projects.
5. Water Management: SoCalGas and SDG&E used recycled water per a Recycled Water Use permit shared with another SoCalGas and SDG&E project. This eliminated additional acquisition and disposal costs.

Pipeline Safety Enhancement Plan Final Report
Supply Line 49-11 Hydrotest Project

B. Cost Estimate

Based on the preliminary design, once the project scope was confirmed and engineering, design, and planning activities were underway, SoCalGas and SDG&E prepared an estimate of the Direct Costs of the Project in the amount of \$5,953,536. This estimate was prepared in May of 2015, using the “SDG&E Pipeline Estimate Template Rev 0” estimating tool, the most current version of the PSEP Estimate Template at the time. The Project Team considered the conditions known at the time to prepare the preliminary Direct Cost estimate. This estimate reflects the projected Labor, Material, and Services costs anticipated to be incurred to execute the revised scope as a hydrotest project.

SoCalGas and SDG&E estimated Indirect Costs of the Project based on the estimated Direct Costs and other project-related variables.

C. Actual Direct and Indirect Costs

Actual Direct Costs reflect the Labor, Material, and Services costs incurred to execute the Project. Actual Indirect Costs reflect costs for incremental overhead loaders in accordance with Company overhead allocation policies. The total loaded cost of the Project is \$7,374,276.

Pipeline Safety Enhancement Plan Final Report
Supply Line 49-11 Hydrotest Project

Table 4: Estimated and Actual Direct Costs and Variances

Direct Costs (\$)	Estimate	Actuals	Delta Over/(Under)
Company Labor	378,978	250,831	(128,147)
Materials	713,121	185,089	(528,032)
Construction Contractor	1,868,083	2,162,923	294,840
Construction Management & Support	273,826	688,902	415,076
Environmental	375,100	244,782	(130,318)
Engineering & Design	926,849	1,583,517	656,668
Project Management & Services	646,460	565,277	(81,183)
ROW & Permits	274,991	286,678	11,687
GMA	496,128	424,008	(72,120)
Total Direct Costs	5,953,536	6,392,007	438,471

Table 5: Estimated and Actual Indirect Costs, Total Costs, and Variances

Indirect Costs/Total Costs (\$)	Estimate	Actuals	Delta Over/(Under)
Overheads	2,853,717	645,636	(2,208,081)
AFUDC	797,324	296,634	(500,690)
Property Taxes	-	39,999	39,999
Total Indirect Costs	3,651,041	982,269	(2,668,772)
Total Direct Costs	5,953,536	6,392,007	438,471
Total Loaded Costs	9,604,577	7,374,276	(2,230,301)

D. Disallowance

For this hydrotest project, SoCalGas and SDG&E identified a total of 871 feet of pipe as being installed post-1955 and lacking pressure test records that provide the minimum information to demonstrate compliance with industry standards or then-applicable strength testing and recordkeeping requirements. Of the 0.878 miles of pipeline that were pressure tested, 871 feet (18.77%) of tested mileage are disallowed, therefore \$490,530 of total project O&M costs are disallowed from recovery.

Pipeline Safety Enhancement Plan Final Report
Supply Line 49-11 Hydrotest Project

INTENTIONALLY LEFT BLANK

Pipeline Safety Enhancement Plan Final Report
Supply Line 49-11 Hydrotest Project

V. CONCLUSION

SoCalGas and SDG&E enhanced the safety of their integrated natural gas transmission system by prudently executing the Supply Line 49-11 Hydrotest Project. Through this Hydrotest Project, SoCalGas and SDG&E successfully hydrotested 0.960 miles of pipe in the City of San Diego. The total loaded cost of the Project is \$7,374,276.

SoCalGas and SDG&E executed this Project prudently by avoiding costs through effectively coordinating with Pipeline Integrity to validate pipe conditions after an inspection run to revise the Project as a hydrotest; and by improving the reliability of the system by removing a faulty PCF, replacing an existing valve, removing a regulator station, and installing a new lateral for a bridled feed.

SoCalGas and SDG&E engaged in prudent cost avoidance efforts by repurposing test water and using it for dust control, sharing a laydown yard, reducing future operating costs by removing a regulator station, improving system reliability and piggability of the line, and rerouting the project design to avoid a future conflict with a planned municipal project that would require a future relocation of the pipeline.

End of Supply Line 49-11 Hydrotest Project Final Report

Pipeline Enhancement Safety Plan Final Report
Line 406 Section 3 Hydrotest Project

I. LINE 406 SECTION 3 HYDROTEST PROJECT

A. Background and Summary

Line 406 is a predominantly [REDACTED] diameter transmission line that runs approximately 51 miles from Ventura to Encino. The line is primarily routed across a Class 3 location. This report describes the activities associated with the Line 406 Section 3 Hydrotest Project, which consists of the hydrotest of 0.433 miles of pipeline in the city of Woodland Hills. The specific attributes of this Project are detailed in Table 1 below. The total loaded cost of the Project is \$2,611,232.

The Line 406 Section 3 Hydrotest Project is a component of Line 406, that was identified in the 2011 PSEP filing¹ as a 20.70 mile hydrotest project. The pipeline is located in the cities of Ventura, Somis, Camarillo, Thousand Oaks, Woodland Hills, and Encino. For project manageability purposes and due to unique characteristics related to non-contiguous portions of the pipeline, SoCalGas and SDG&E divided Line 406 into multiple project sections to be executed and managed individually. This report summarizes activity and actual costs related to Line 406 Section 3 only.

SoCalGas and SDG&E presented five of the sections, 1, 2, 2A, 4, and 5, in its 2016 Reasonableness Review Application². The Project Team delayed execution of Section 3 following additional review that determined the Project should be executed as a hydrotest rather than a replacement as originally scoped. Section 3 is a nearly half mile long section of pipeline that runs through a residential neighborhood in Woodland Hills and then along a heavily travelled thoroughfare adjacent to a public high school.

¹ See Amended December 2, 2011 Pipeline Safety Enhancement Plan (PSEP) of SoCalGas and SDG&E.

² See A.16-09-005, Exhibit 32, WP-III-A275-A300.

Pipeline Enhancement Safety Plan Final Report Line 406 Section 3 Hydrotest Project

Table 1: General Project Information

Project Name	Line 406 Section 3		
Project Type	Hydrotest		
Length	0.433 mile		
Location	Woodland Hills		
Class	3		
MAOP (<i>confidential</i>)	[REDACTED]		
Pipe Vintage	1949		
Construction Start	06/13/2016		
Construction Finish	08/12/2016		
Original Pipe Diameter ³ (<i>confidential</i>)	[REDACTED]		
New Diameter (<i>confidential</i>)	N/A		
Original SMYS ⁴ (<i>confidential</i>)	[REDACTED]		
New SMYS (<i>confidential</i>)	N/A		
Project Costs (\$)	Capital	O&M	Total
Loaded Project Costs	389,620	2,221,612	2,611,232
Disallowed Costs	-	-	-

³ Diameter of Category 4 Criteria pipe that was addressed.

⁴ Highest percentage of Specified Minimum Yield Strength (SMYS) of Category 4 Criteria pipe.

Pipeline Enhancement Safety Plan Final Report
Line 406 Section 3 Hydrotest Project

B. Maps and Images

Figure 1: Satellite Image of Line 406 Section 3 Hydrotest Project



Pipeline Enhancement Safety Plan Final Report Line 406 Section 3 Hydrotest Project

Figure 2: Overview Map of Line 406 Section 3 Hydrotest Project



Pipeline Enhancement Safety Plan Final Report
Line 406 Section 3 Hydrotest Project

II. ENGINEERING, DESIGN, AND PLANNING

A. Project Scope

Table 2: Mileage Information

	Criteria	Accelerated ⁵	Incidental	Total ⁶
Final Mileage	0.195 mi.	0.237 mi.	0.001 mi.	0.433 mi.
	1,031 ft.	1,252 ft.	3 ft.	2,286 ft.

SoCalGas and SDG&E presented a conceptual project scope in workpapers supporting the 2011 PSEP filing.⁷ Prior to initiating execution of the Project in 2016, SoCalGas and SDG&E reviewed existing pipeline records to validate the scope of the Project. During the Engineering, Design and Planning phase, SoCalGas and SDG&E further refined the scope. This progression of the project scope is summarized as follows:

1. 2011 PSEP Filing: SoCalGas and SDG&E identified Line 406 as a Phase 1A Hydrotest Project comprised of 7.863 Category 4 Criteria miles and 12.838 miles of Accelerated pipe.
2. Scope Validation: Through scope validation activities, after the 2011 filing and before initiating execution of the Project, SoCalGas and SDG&E successfully reduced the scope of the Project by 7.668 miles of Category 4 Criteria pipe.

⁵ Accelerated mileage includes Phase 2B pipe. Phase 2B includes pipelines with record of a pressure test, but without record of a pressure test to modern – Subpart J – standards (Phase 2B). The Accelerated mileage was included to realize efficiencies and to enhance project constructability.

⁶ Values may not add to total due to rounding.

⁷ See Amended PSEP of SoCalGas and SDG&E, submitted December 2, 2011, in R.11-02-019 and subsequently transferred to A.11-11-002.

Pipeline Enhancement Safety Plan Final Report
Line 406 Section 3 Hydrotest Project

3. Engineering, Design and Constructability:

- a. As the project design progressed, SoCalGas and SDG&E identified six non-contiguous project sections, Sections 1, 2, 2A, 3, 4 and 5. For constructability and scheduling purposes, the Project Team decided to manage and execute Section 3 as a separate project after further analysis prompted a change to the project scope from a replacement to a hydrotest project.
- b. The Project Team revised the design and location of the test ends, the eastern test end was moved to mitigate the impact on two residential properties, which added Accelerated mileage, and the western test end was moved out of a narrow alley to a more desirable location, that added Incidental mileage.

4. Final Project Scope: The final project scope consists of a 0.433 mile Hydrotest. The Accelerated mileage consists of 0.237 miles of Phase 2B pipe and 3 feet of Incidental pipe.

B. Decision Tree Analysis

SoCalGas and SDG&E performed a PSEP Decision Tree analysis of Line 406 Section 3 and initially confirmed the project design should commence as a Replacement Project.

For pipeline segments, longer than 1,000 feet in length, under the approved PSEP Decision Tree, SoCalGas and SDG&E complete a preliminary review to determine whether SoCalGas and SDG&E can manage customer service impacts if the pipeline segment is taken out of service for a period of two to six weeks to complete pressure testing. Where mitigation of customer impacts to remove the line from service for pressure testing is feasible, SoCalGas and SDG&E compare the costs, constructability, risks and benefits of pressure testing and replacement to determine whether pressure testing or replacement is the more prudent option.

Pipeline Enhancement Safety Plan Final Report
Line 406 Section 3 Hydrotest Project

Through this Decision Tree analysis, SoCalGas and SDG&E identified replacement as the more prudent option. Key considerations that support SoCalGas and SDG&E's determination to replace this segment include:

1. Piggability: Piggable.
2. Pipe Vintage: 1949.
3. Long Seam Type: Seamless; Electric Resistance Weld (ERW).
4. Site Observations:
 - a. Temporary relocation of overhead utilities would be required for the replacement scenario.
 - b. One of the customers potentially impacted was opposed to the replacement of the pipe.
 - c. The original alignment traversed down a 30 foot wide alley, across a street, and in front of a residential driveway in between two homes, thus necessitating relocation of the occupants of two residents.
 - d. The proposed western test end was located down a 30 foot wide alley, limiting space for construction staging and activities.

As planning and design progressed, SoCalGas and SDG&E determined that hydrotesting would be the best option because:

- a. The Project Team would not need to relocate overhead utilities;

Pipeline Enhancement Safety Plan Final Report
Line 406 Section 3 Hydrotest Project

- b. There would be less impact to the residences, as no relocation would be required;
- c. Reduced overall length and efforts required for excavations, staging, and permitting costs.

C. Engineering, Design, and Planning Factors

SoCalGas and SDG&E reviewed pipeline drawings and other information, contacted internal planning groups, communicated with external stakeholders, conducted survey activities, including reviewing public records and potholing of the area to confirm the presence of underground utilities and substructures, and completed a pre-design site walk. Key factors that influenced the engineering and design of the Project are as follows:

1. Shut-In Analysis: The Project Team completed a Request for Engineering Review (RER) analysis and concluded that all taps were bridled, and service would not be interrupted.
2. Schedule Coordination: Since the Project location was adjacent to the Line 404 Section 9 Hydrotest Project⁸, the Project Team coordinated construction schedules and shared the same laydown yard. Costs for the laydown yard were shared evenly between the two projects.
3. Permit Conditions: A 12-month lead time was required to obtain the necessary permits. A traffic control permit would allow permanent closure of a section of Burbank Boulevard during construction activities. An exemption from the City of Los Angeles was obtained to allow construction activity and a permit to partially obstruct traffic during peak traffic hours.

⁸ The Final Report for Line 404 Section 9 Hydrotest Project is included in workpapers supporting SoCalGas and SDG&E's the 2018 PSEP Reasonableness Review application.

Pipeline Enhancement Safety Plan Final Report
Line 406 Section 3 Hydrotest Project

4. Schedule Delay: Due to storage and system availability, the construction start date was delayed by three months, from March 2016 to June 2016, while the Operating District evaluated the potential system impacts to shutting in Line 404 and Line 406.
5. Traffic Control: The change in scope from a replacement to a hydrotest required a reapplication of the permit to the City of Los Angeles. With the 12-month lead time required for the permit, the Project Team rescheduled the Project's construction start date from the original start of June 2015 to June 2016.

D. Scope Changes

Through engineering, design, and planning activities, SoCalGas and SDG&E determined that changes in scope were appropriate to enhance the design of the Project and address engineering factors. As discussed above, the project scope changed from a replacement project to a hydrotest. As a result, the estimate reflects the revised scope.

Pipeline Enhancement Safety Plan Final Report
Line 406 Section 3 Hydrotest Project

III. CONSTRUCTION

A. Construction Contractor Selection

The Project Team prepared an initial cost estimate based on the preliminary design. Following completion of the engineering, design and planning activities described above, the Project Team directed the Performance Partner to prepare cost estimates based on a more detailed engineering design package, which included the updated design described in the discussion of notable Scope Changes above. SoCalGas and SDG&E awarded the construction contract to the Performance Partner.

1. SoCalGas and SDG&E’s Preliminary Construction Cost Estimate (*confidential*):
SoCalGas and SDG&E’s preliminary cost estimate for construction was [REDACTED]
2. Construction Contractor’s Target Price Estimate (*confidential*): The Construction Contractor’s cost estimate was [REDACTED], which was [REDACTED] than SoCalGas and SDG&E’s preliminary cost estimate for construction.

B. Construction Schedule

Table 3: Construction Timeline

Construction Start Date	06/13/2016
Construction Completion Date	08/12/2016
NOP Date	07/13/2016

C. Changes During Construction

SoCalGas and SDG&E successfully mitigated conditions during construction in a manner that minimized potential impacts on project scope, cost, and schedule. As a result, these conditions did not result in any notable change orders.

Pipeline Enhancement Safety Plan Final Report
Line 406 Section 3 Hydrotest Project

Figure 3: Exposing Line 406 at Westside Station



Pipeline Enhancement Safety Plan Final Report
Line 406 Section 3 Hydrotest Project

Figure 4: Unloading Pipe at East Laydown Yard



Pipeline Enhancement Safety Plan Final Report
Line 406 Section 3 Hydrotest Project

Figure 5: Fabricating Test Loops



Pipeline Enhancement Safety Plan Final Report
Line 406 Section 3 Hydrotest Project

Figure 6: Pump and Test Head at Burbank Boulevard



Pipeline Enhancement Safety Plan Final Report
Line 406 Section 3 Hydrotest Project

Figure 7: Crew Lowering Tie-in Piece at Burbank Boulevard



Pipeline Enhancement Safety Plan Final Report
Line 406 Section 3 Hydrotest Project

Figure 8: Lowering Tie-in Piece at Burbank Boulevard



Pipeline Enhancement Safety Plan Final Report
Line 406 Section 3 Hydrotest Project

Figure 9: Coating Check Prior to Backfill



Pipeline Enhancement Safety Plan Final Report
Line 406 Section 3 Hydrotest Project

Figure 10: Backfilling Bell Hole Line 406 at Burbank Boulevard



Pipeline Enhancement Safety Plan Final Report
Line 406 Section 3 Hydrotest Project

D. Commissioning and Site Restoration

Commissioning activities include restoration of the site, final inspection and placement of the pipeline back into service, transportation and disposal of hydrotested water and hazardous material, and site demobilization. Closeout activities include development of final drawings, finalization of a reconciliation package, and updates to company recordkeeping systems to reflect the completed scope of work.

Pipeline Enhancement Safety Plan Final Report
Line 406 Section 3 Hydrotest Project

IV. PROJECT COSTS

A. Cost Avoidance Actions

SoCalGas and SDG&E exercised due diligence in the planning, design, and construction activities for this project to minimize or avoid costs when prudent to do so. As discussed above, the Project Team conducted a site visit to identify and incorporate discernible site conditions into the engineering, design, and planning of the Project. Specific examples of cost avoidance actions taken on this project are:

1. Materials:
 - a. Bulk ordered pipe provided volume pricing for the [REDACTED] pipe.
 - b. The Project Team used test heads from available inventory rather than fabricating new ones.
2. Land Use: Laydown yards were shared with the adjacent Line 404 Section 9 Hydrotest project.
3. Water Management: The Project Team reused the hydrotest water from this project for the adjacent Line 404 Section 9 Hydrotest Project, and later shipped the water off site for disposal at a SoCalGas and SDG&E-approved treatment facility.
4. Planning and Coordination: As indicated above, the Project Team executed the Project in coordination with the Line 404 Section 9 Hydrotest Project. In addition to sharing laydown yards and test water, SoCalGas and SDG&E were able to avoid additional construction contractor, permitting, environmental monitor, and inspection crew costs.

Pipeline Enhancement Safety Plan Final Report
Line 406 Section 3 Hydrotest Project

B. Cost Estimates

Based on the preliminary design, once the project scope was confirmed and engineering, design and planning activities were underway, SoCalGas and SDG&E prepared an estimate of the Direct Costs of the Project in the amount of \$2,800,807. This estimate was prepared in September of 2015, using the “SCG Pipeline Estimate Template Rev 0” estimating tool, the most current version of the PSEP Estimate Template at the time. The Project Team considered the conditions known at the time to prepare the preliminary Direct Cost estimate. This estimate reflects the projected Labor, Material, and Services costs anticipated to be incurred to execute the Project.

SoCalGas and SDG&E estimated Indirect Costs of the Project based on the estimated Direct Costs and other project related variables.

C. Actual Direct and Indirect Costs

Actual Direct Costs reflect the Labor, Material, and Service costs incurred to execute the Project. Actual Indirect Costs reflect costs for incremental overhead loaders in accordance with Company overhead allocation policies. The total loaded cost of the Project is \$2,611,232.

Pipeline Enhancement Safety Plan Final Report
Line 406 Section 3 Hydrotest Project

Table 4: Estimated and Actual Direct Costs and Variances

Direct Costs (\$)	Estimate	Actuals	Delta Over/(Under)
Company Labor	219,614	186,726	(32,888)
Materials	81,536	67,623	(13,913)
Construction Contractor	1,115,050	577,780	(537,270)
Construction Management & Support	217,625	169,909	(47,716)
Environmental	64,494	116,782	52,288
Engineering & Design	640,269	754,170	113,901
Project Management & Services	128,755	224,407	95,652
ROW & Permits	37,444	2,496	(34,948)
GMA	296,020	275,351	(20,669)
Total Direct Costs	2,800,807	2,375,244	(425,563)

Table 5: Estimated and Actual Indirect Costs, Total Costs, and Variances

Indirect Costs/Total Costs (\$)	Estimate	Actuals	Delta Over/(Under)
Overheads	23,122	215,075	191,953
AFUDC	18,466	18,565	99
Property Taxes	4,175	2,348	(1,827)
Total Indirect Costs	45,763	235,988	190,225
Total Direct Costs	2,800,807	2,375,244	(425,563)
Total Loaded Costs	2,846,570	2,611,232	(235,338)

Pipeline Enhancement Safety Plan Final Report
Line 406 Section 3 Hydrotest Project

D. Disallowances

There was no disallowance for the Line 406 Section 3 Hydrotest Project as there were no post-1955 segments included in the Project without records that provide the minimum information to demonstrate compliance with then applicable industry standards or regulatory strength testing and recordkeeping requirements.

Pipeline Enhancement Safety Plan Final Report
Line 406 Section 3 Hydrotest Project

V. CONCLUSION

SoCalGas and SDG&E enhanced the safety of their integrated natural gas transmission system by prudently executing the Line 406 Section 3 Hydrotest Project. Through this Hydrotest Project, SoCalGas and SDG&E successfully hydrotested 0.433 miles of pipe in the City of Woodland Hills. The total loaded cost of the Project is \$2,611,232.

SoCalGas and SDG&E executed this Project prudently through minimizing customer impacts by hydrotesting rather than replacing this section of pipe. The Project Team safely performed a hydrotest on a major thoroughfare, using a combination of internal and Performance Partner construction management to complete the safety enhancement work as soon as practicable.

SoCalGas and SDG&E engaged in prudent cost avoidance efforts by avoiding costs through purchasing pipe through bulk order, sharing resources such as land use and hydrotest water with the Line 404 Section 9 Project, and overall execution efficiencies by executing the two projects together.

End of Line 406 Section 3 Hydrotest Project Final Report

Pipeline Safety Enhancement Plan Final Report
Line 2000-C Desert Hydrotest Project

I. LINE 2000-C DESERT HYDROTEST PROJECT

A. Background and Summary

Line 2000 is a predominantly [REDACTED] diameter transmission line that runs approximately 225 miles from the California/Arizona border in Blythe to the Los Angeles Basin. The pipeline is primarily routed across a Class 1 location. This report describes the activities associated with the Line 2000-C Desert Hydrotest Project that consists of four separate hydrotests that totaled approximately eight miles, spanning approximately across 27 miles, and repairs associated with a hydrotest failure. The specific attributes of this Project are detailed in Table 1 below. The total loaded cost of the Project is \$13,952,619.

SoCalGas and SDG&E separated the Line 2000 Project into four separate projects: Line 2000-A¹, Line 2000-B, Line 2000-C, and Line 2000-West for project manageability purposes and due to unique characteristics related to non-contiguous portions of the pipeline.

¹ Line 2000-A Hydrotest Project was submitted for reasonableness review in A.14-12-016 and was approved in D.16-12-063.

Pipeline Safety Enhancement Plan Final Report
Line 2000-C Desert Hydrotest Project

Table 1: General Project Information

Project Name	Line 2000-C		
Project Type	Hydrotest		
Length	7.585 miles		
Location	Indio, Palm Springs, Cathedral City, Thousand Palms, and Desert Hot Springs		
Class	3		
MAOP (<i>confidential</i>)	[REDACTED]		
Pipe Vintage	1947		
Construction Start	01/30/2017		
Construction Finish	05/25/2017		
Original Pipe Diameter (<i>confidential</i>)	[REDACTED]		
New Diameter (<i>confidential</i>)	N/A		
Original SMYS ² (<i>confidential</i>)	[REDACTED]		
New SMYS (<i>confidential</i>)	[REDACTED]		
Project Costs (\$)	Capital	O&M	Total
Loaded Project Costs	3,085,607	10,867,012	13,952,619
Disallowed Costs	-	-	-

² Highest percentage of Specified Minimum Yield Strength (SMYS) of Category 4 Criteria pipe.

Pipeline Safety Enhancement Plan Final Report
Line 2000-C Desert Hydrotest Project

B. Maps and Images

Figure 1: Satellite Image of Line 2000-C Desert Hydrotest Project

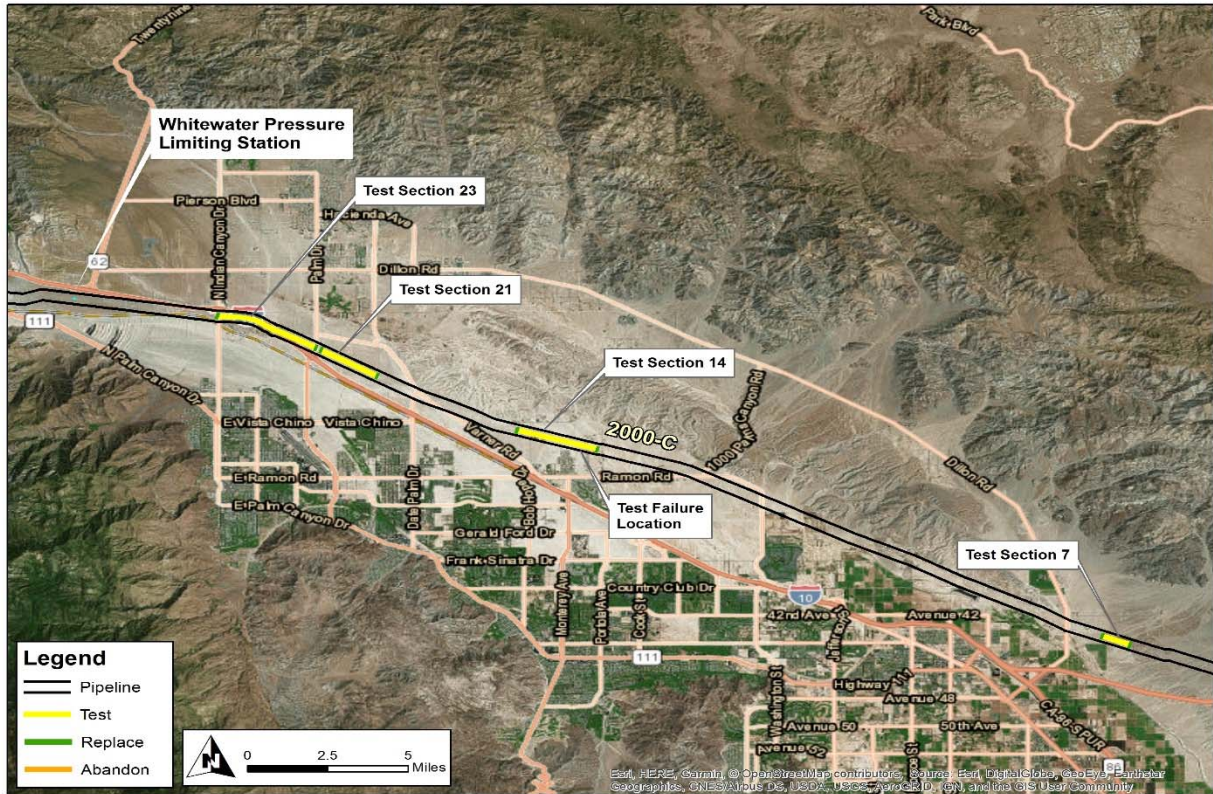

Pipeline Safety Enhancement Plan Final Report
 Line 2000-C Desert Hydrotest Project

Figure 2: Overview Map of Line 2000-C Desert Hydrotest Project

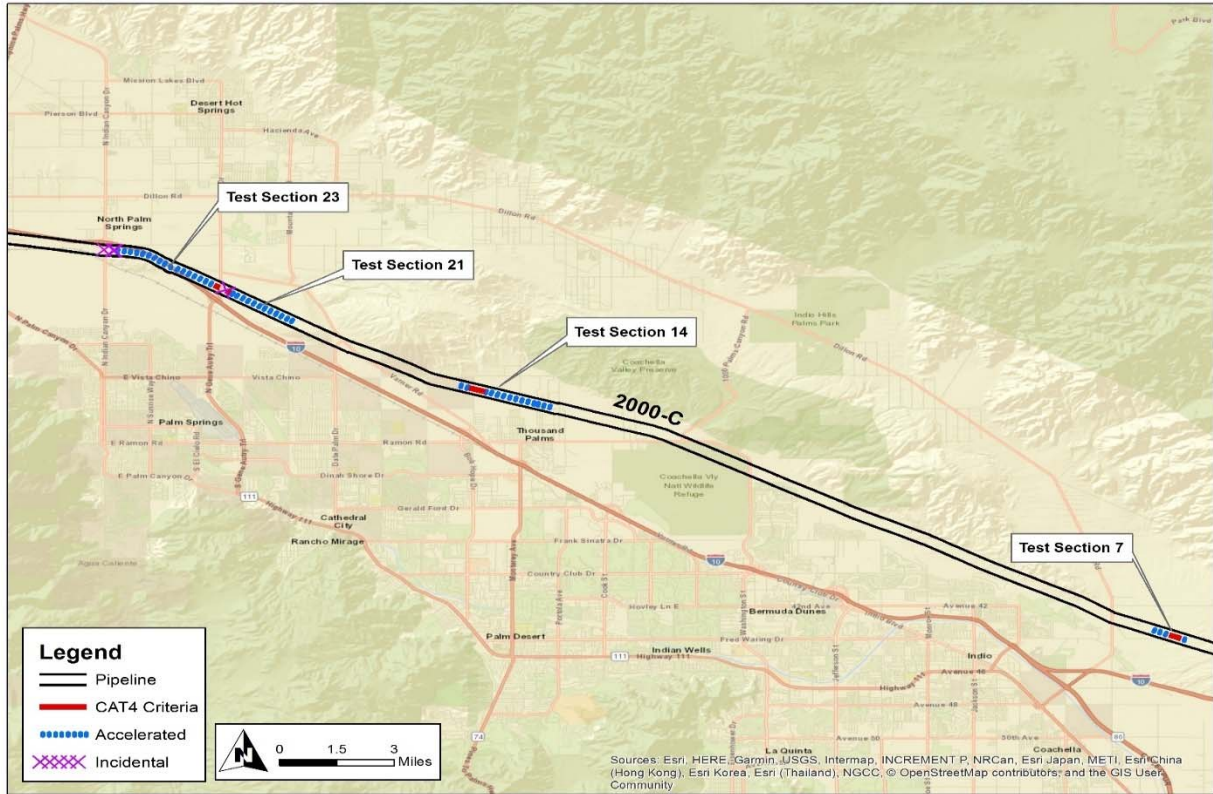

Pipeline Safety Enhancement Plan Final Report
Line 2000-C Desert Hydrotest Project

Figure 3: Satellite Image of Section 7, Line 2000-C Desert Hydrotest Project

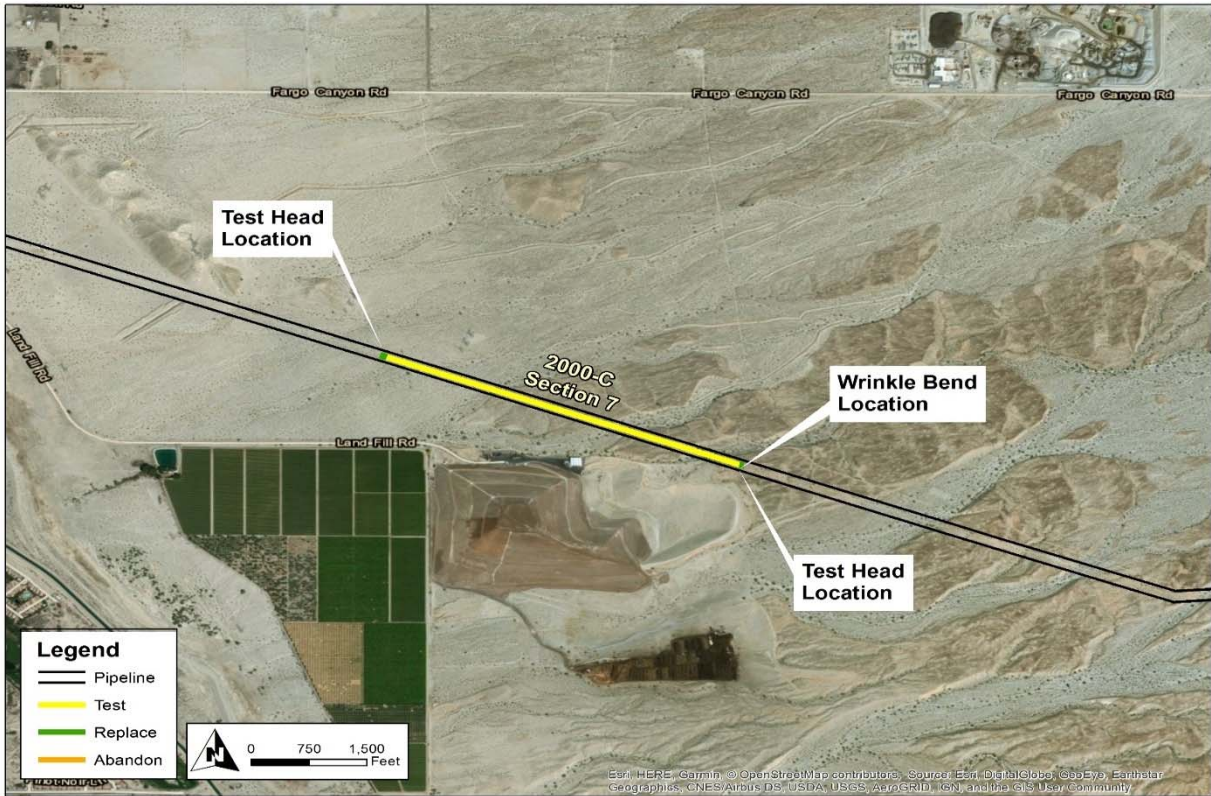

Pipeline Safety Enhancement Plan Final Report
Line 2000-C Desert Hydrotest Project

Figure 4: Overview Map of Section 7, Line 2000-C Desert Hydrotest Project



Pipeline Safety Enhancement Plan Final Report
 Line 2000-C Desert Hydrotest Project

Figure 6: Overview Map of Section 14, Line 2000-C Desert Hydrotest Project



Pipeline Safety Enhancement Plan Final Report
Line 2000-C Desert Hydrotest Project

Figure 7: Satellite Image of Section 21 and 23, Line 2000-C Desert Hydrotest Project

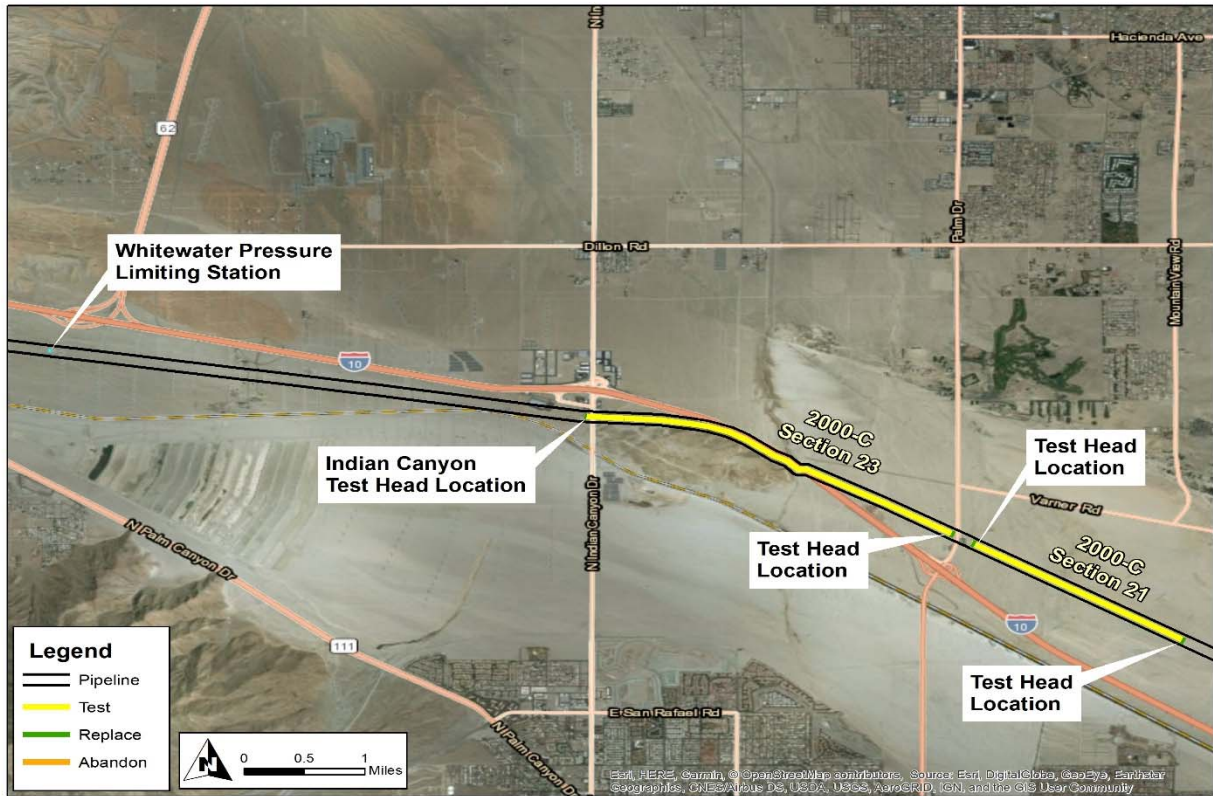

Pipeline Safety Enhancement Plan Final Report
Line 2000-C Desert Hydrotest Project

Figure 8: Overview Map of Section 21 and 23, Line 2000-C Desert Hydrotest Project



Pipeline Safety Enhancement Plan Final Report
Line 2000-C Desert Hydrotest Project

II. ENGINEERING, DESIGN, AND PLANNING

A. Project Scope

Table 2: Mileage Information³

	Criteria	Accelerated ⁴	Incidental	New	Total ⁵
Final Mileage	0.947 mi.	6. 401638 mi.	0. 244006 mi.	0 mi	7.585 mi.
	4,999 ft.	33,7975,051 -ft.	1,28632 -ft.	0 ft.	40,047 ft.

SoCalGas and SDG&E presented a conceptual project scope in workpapers supporting the 2011 PSEP filing.⁶ Prior to initiating execution of the Project in 2017, SoCalGas and SDG&E reviewed existing pipeline records to validate the scope of the Project. During the Engineering, Design, and Planning phase, SoCalGas and SDG&E further refined the scope. The progression of project scope is summarized as follows:

1. 2011 PSEP Filing: SoCalGas and SDG&E identified Line 2000 as a Phase 1A Hydrotest Project comprised of 55.027 miles of Category 4 Criteria pipe and 62.574 miles of Accelerated pipe.
2. Scope Validation: Through scope validation activities, after the 2011 filing and before initiating execution of the Line 2000 Project, SoCalGas and SDG&E successfully reduced the scope of the Project by 32.408 miles of Category 4 Criteria pipe.

³ Total mileage of the completed project differs from the mileage of the pipe addressed due to realignment of the pipeline route.

⁴ Accelerated mileage includes Phase 2A and Phase 2B pipe. Phase 2 includes pipelines without sufficient record of a pressure test in less populated areas (Phase 2A) or pipelines with record of a pressure test, but without record of a pressure test to modern – Subpart J – standards (Phase 2B). The Accelerated mileage was included to realize efficiencies and to enhance project constructability.

⁵ Values may not add to total due to rounding.

⁶ See Amended PSEP of SoCalGas and SDG&E, submitted December 2, 2011, in R.11-02-019 and subsequently transferred to A.11-11-002.

Pipeline Safety Enhancement Plan Final Report
Line 2000-C Desert Hydrotest Project

successfully reduced the scope of the Project by 32.408 miles of Category 4 Criteria pipe.

Pipeline Safety Enhancement Plan Final Report
Line 2000-C Desert Hydrotest Project

3. Engineering, Design, and Constructability:

- a. For constructability and project management purposes, SoCalGas and SDG&E divided the 32.408 miles of Category 4 Criteria pipe into four separate projects: Line 2000-A Hydrotest Project, Line 2000-B Hydrotest Project, Line 2000-C Desert Hydrotest Project, Line 2000-West Hydrotest Project. This report describes the activities associated with the Line 2000-C Desert Hydrotest Project.
- b. The Project Team identified the sections of Line 2000 between the cities of Indio and Banning that required testing or replacement. The Project Team would split the replacement, Line 2000-C Desert Hydrotest Project into additional sections east of the Whitewater Pressure Limiting Station because of a change in MAOP. All sections west of the station will be addressed in a future project⁷.
- c. The Line 2000-C Desert Hydrotest Project was planned and designed to include Phase 1A and Phase 2 mileage to determine the entire project scope including the hydrotest section start and stop locations.
- d. SoCalGas and SDG&E decided to proceed with the Phase 1A sections while awaiting Commission approval to begin Phase 2A projects.

4. Final Project Scope: The final project scope consists of four separate hydrotests that total 7.585 miles, a wrinkle bend removal, and repairs associated with a hydrotest failure. The Accelerated mileage consists of 6.236 miles of Phase 2A pipe, 0.165403 miles of Phase 2B pipe, and 0.244 miles^{32 feet} of Incidental pipe.

⁷ PSEP Line 2000-D Hydrotest Project will be submitted for reasonableness review in a future filing.

Pipeline Safety Enhancement Plan Final Report
Line 2000-C Desert Hydrotest Project

B. Decision Tree Analysis

SoCalGas and SDG&E performed a PSEP Decision Tree analysis of Line 2000-C Desert Hydrotest and confirmed the project design should commence as a Hydrotest project.

For pipeline segments longer than 1,000 feet in length, under the approved PSEP Decision Tree, SoCalGas and SDG&E complete a preliminary review to determine whether SoCalGas and SDG&E can manage customer service impacts if the pipeline segment is taken out of service for a period of two to six weeks to complete pressure testing. Where mitigation of customer impacts to remove the line from service for pressure testing is feasible, SoCalGas and SDG&E compare the costs, constructability, risks, and benefits of pressure testing and replacement to determine whether pressure testing or replacement is the more prudent option.

Through this Decision Tree analysis, SoCalGas and SDG&E identified pressure testing as the more prudent option. Key considerations that support SoCalGas and SDG&E's determination to pressure test this segment include:

1. Piggability: Piggable.
2. Existing Pipe Attributes: Wrinkle bends were identified but did not make the line non-piggable. If any wrinkle bends were within or near a planned excavation, they would be replaced.
3. Pipe Vintage: 1947.
4. Longseam Type: Majority of long seams are double submerged arc-welded (DSAW) and single submerged arc-welded (SSAW).

Pipeline Safety Enhancement Plan Final Report
Line 2000-C Desert Hydrotest Project

5. Longseam Repair History: Reported long seam repairs during manufacture.
6. Condition of Coating: No identified issues.
7. History of Leaks: No identified issues.
8. Constructability: In line inspections confirmed that the pipe was in good condition and supported the decision to hydrotest.

C. Engineering, Design, and Planning Factors

SoCalGas and SDG&E reviewed pipeline drawings and other information, contacted internal planning groups, communicated with external stakeholders, and conducted survey activities, including reviewing public records of the area to confirm the presence of underground utilities and substructures, and completed a pre-design site walk. Key factors that influenced the engineering and design of the Project are as follows:

1. Shut-In Analysis: The Project Team completed a Request for Engineering Review (RER) analysis and concluded that the line could be taken out of service after two nearby transmission lines had completed their inline inspection, and the results were analyzed, and approved.
2. Engineering: SoCalGas and SDG&E noted that Line 2000 was operating at a lower MAOP since the San Bruno Incident⁸ and planned to test to the original MAOP to return the line to the normal operating pressure and flow capacity once the Category 4 Criteria segments were hydrotested or replaced.

⁸ The operating pressure of Line 2000 was lowered after the September 2010 San Bruno incident.

Pipeline Safety Enhancement Plan Final Report
Line 2000-C Desert Hydrotest Project

3. Constructability:
4. As stated above, Line 2000-C was initially planned and designed to include Phase 1A and Phase 2 mileage. The parameters for determining test ends were:
 - a. Maximize length of hydrotest sections.
 - b. Changes in elevation.
 - c. Locations outside of sensitive areas⁹.
 - d. Water access.

Specific parameters for each of the Hydrotest Sections are as follows:

- i. Test Section 7 was chosen because the elevation difference between the high and low point in the section would not create enough static head to exceed testing limits of the weakest component. Once this was satisfied, the breaks were shifted to a suitable location – i.e., flat surface, outside of washes, etc.
- ii. Test Section 14 was chosen such that the elevation difference between the high and low point in the section would not create enough static head to exceed testing limits of the weakest component. Once this was satisfied, the breaks were shifted to a suitable location – i.e., flat surface, outside of washes, etc.

⁹ Such as environmentally sensitive areas, and areas owned by jurisdictional agencies such as Bureau of Land Management, Coachella Valley Association of Governments.

Pipeline Safety Enhancement Plan Final Report
Line 2000-C Desert Hydrotest Project

- iii. Test Section 21 east end was chosen to coincide with the end of the Class 1 location and the beginning of the Class 3 location. The west end was chosen such that the elevation difference between the high and low point in the section would not create enough static head to exceed testing limits of the weakest component. Once this was satisfied, the breaks were shifted to a suitable location – i.e., flat surface, outside of washes, etc.
 - iv. Test Section 23 east end was chosen to coincide with the end of the Class 1 location and the beginning of the Class 3 location. The west end was chosen such that the elevation difference between the high and low point in the section would not create enough static head to exceed testing limits of the weakest component. Once this was satisfied, the breaks were shifted to a suitable location – i.e., flat surface, outside of washes, etc.
5. Environmental¹⁰: In addition to the engineering factors, the following environmental factors were identified and taken into consideration when determining test end and work site locations:
- a. As engineering and design progressed, a reptile species native to areas of work identified was given candidate status on the California Endangered Species List, and the species would receive all the protections that an endangered species is given until the determination of its status is finalized.

¹⁰ Various work areas were identified as being in a geographical area addressed by a Biological Opinion for Ongoing Operations and Maintenance Activities on Southern California Gas Company's Pipeline System in the Southern California Deserts (BO) (USFWS, 1995) and California Endangered Species Act 2081 Memorandum of Understanding and Management Authorization (CESA MOU) (California Department of Fish and Wildlife [CDFW], 1997).

Pipeline Safety Enhancement Plan Final Report
Line 2000-C Desert Hydrotest Project

This species was not covered under the programmatic permit that SoCalGas and SDG&E were intending to use for the Project. Options were discussed with the California Department of Fish and Wildlife (CDFW), and shortly after, SoCalGas and SDG&E reviewed these options and associated risks, along with consideration of the pending decision from the Commission regarding Phase 2, and ultimately decided to proceed with only test sections that contained Phase 1A mileage.

- b. The Project Team situated the work areas approximately perpendicular to, and not within, the watershed from the Indio Hills and the Little San Bernardino Mountains to the north.
- c. The gas pipeline and existing access roads cross many potentially jurisdictional features¹¹ regulated by the United States Army Corps of Engineers (USACE), Regional Water Quality Control Board (RWQCB), and CDFW. The Project Team strategically sited the disturbance areas to avoid the jurisdictional features.
- d. In compliance with the Migratory Bird Treaty Act (MBTA), if construction was scheduled during the nesting bird season, and if active nests were identified during a pre-construction survey, a protective buffer (or no work zone) around the nest may be delineated and work will be postponed until the birds have fledged. If other special status wildlife species were observed in the work area, a qualified biologist will determine whether species removal, exclusion fencing, or work stoppage is required. Coordination with the appropriate wildlife agencies may be required to determine the best avoidance, minimization, and compliance measures for the particular species.

¹¹ Features such as waterways, creeks, and dry washes.

Pipeline Safety Enhancement Plan Final Report
Line 2000-C Desert Hydrotest Project

- e. The Project is located in the Coachella Valley, within the jurisdiction of South Coast Air Quality Management District (SCAQMD) and subject to Rule 403 dust control requirements and Rule 403.1 that supplements fugitive dust requirements for Coachella Valley sources.
 - f. Due to the large amount of water needed, the cost of transporting water via water truck was relatively high. The Project Team planned for water discharge to be treated after the hydrotest with a mobile water treatment system and then discharge the water to the ground in accordance with SoCalGas and SDG&E's Region 7 Programmatic Permit for Discharges to Land.
 - g. Due to the vintage of the pipe, the Project Team assumed that the pipe was coated with asbestos containing material (ACM) coal tar wrap.
6. Valves: The Project Team planned to relocate an existing tap valve configuration at Indian Canyon Road (near the west end of Test Section 23) for two reasons – the main reason was to accommodate a planned future road expansion that would move the valve out of the middle of the new roadway. The second reason was that this section of the pipeline would need to be isolated for the hydrotest. The Project Team decided to take advantage of the hydrotest shut-in, to relocate the tap valve configuration, and at the same time, replace the tap valve and the fire control valve.
7. Customer Impacts: There were no customer interruptions or impacts anticipated because all taps within the scope of this Project were bridled to an adjacent line.
8. Community Impacts: There were minimal community impacts that included traffic control for one of the laydown yards and did not impact design.

Pipeline Safety Enhancement Plan Final Report
Line 2000-C Desert Hydrotest Project

9. Permitting: The following permits and notifications were anticipated:
- a. City of Palm Springs Encroachment Permit and Traffic Control Plan Permit.
 - b. Coachella Valley Water District hydrant use permit.
 - c. County of Riverside Bureau of Land Management notification as coverage would be under SoCalGas and SDG&E current programmatic California Desert Conservation Area (CDCA) Biological Opinion permit.
 - d. The CDFW notification, as coverage, would be under the SoCalGas and SDG&E current programmatic CDCA Memorandum of Understanding.
 - e. South Coast Air Quality Management District 403.1 Dust Control Plan.

D. Scope Changes

SoCalGas and SDG&E did not make any notable scope changes during detailed design.

Pipeline Safety Enhancement Plan Final Report
Line 2000-C Desert Hydrotest Project

III. CONSTRUCTION

A. Construction Contractor Selection

The Project Team prepared an initial cost estimate based on the preliminary design. Following completion of the engineering, design, and planning activities described above, SoCalGas and SDG&E entered into a competitive bidding process to select a construction contractor. As indicated above, there were no notable changes in scope between the time when the Project Team prepared the preliminary cost estimate and when the Project was bid. SoCalGas and SDG&E awarded the construction contract to the bidder that best met the selection criteria for this project.

1. SoCalGas and SDG&E’s Preliminary Construction Cost Estimate (*confidential*):
SoCalGas and SDG&E’s preliminary estimate for construction was [REDACTED].
2. Construction Contractor’s Bid (*confidential*): The Construction Contractor’s bid was [REDACTED], that was [REDACTED] than SoCalGas and SDG&E’s preliminary cost estimate for construction.

B. Construction Schedule

Table 3: Construction Timeline

Construction Start Date	01/30/2017
Construction Completion Date	05/25/2017
NOP Date	05/19/2017

Pipeline Safety Enhancement Plan Final Report
Line 2000-C Desert Hydrotest Project

C. Changes During Construction

The conditions summarized below were encountered during construction. Activities to address or mitigate these conditions resulted in approximately \$557,000 in change orders.

1. Hydrotest Failure: Due to a line rupture during the hydrotest of Test Section 14, both the Project Team and Construction Contractor conducted additional activities that included:
 - a. Implementation of the hydrotest failure mitigation plan.
 - b. Additional abatement.
 - c. Replacement of ruptured pipe segment.
 - d. Re-hydrotest of the pipe section after the replacement was completed.
2. Constructability Issues: Due to an anomaly identified along the long seam during tie-in preparation activities west of the final tie-in, the Project Team directed the Construction Contractor to replace the spool of [REDACTED] pipe and to restore site conditions. In addition to the removal and replacement of the pipe spool, additional abatement was also required.
3. Site Conditions: Due to insufficient soil cover in identified areas, such as roadways utilized by construction vehicles, the Project Team requested that the Construction Contractor provide additional coverage over Line 2000 and Line 2001 in these areas to meet SCG standards. Additionally, steel plates were utilized to ensure even weight distribution for trucks and equipment moving within the work areas.

Pipeline Safety Enhancement Plan Final Report
Line 2000-C Desert Hydrotest Project

Figure 9: Temporary Pipe Supports (TB-7) Under Line 2000 in Preparation for a Test Break



Pipeline Safety Enhancement Plan Final Report
Line 2000-C Desert Hydrotest Project

Figure 10: Temporary Lake Tank to Store Water for Hydrotest



Pipeline Safety Enhancement Plan Final Report
Line 2000-C Desert Hydrotest Project

Figure 11: Hydrotest Rupture



Pipeline Safety Enhancement Plan Final Report
Line 2000-C Desert Hydrotest Project

Figure 12: Hydrotest Rupture (close up)



Pipeline Safety Enhancement Plan Final Report
Line 2000-C Desert Hydrotest Project

D. Commissioning and Site Restoration

Commissioning activities include restoration of the site, final inspection and placement of the pipeline back into service, transportation, and disposal of hydrotested water and hazardous material, and site demobilization. Closeout activities include development of final drawings, finalization of a reconciliation package, and updates to company recordkeeping systems to reflect the completed scope of work.

Pipeline Safety Enhancement Plan Final Report
Line 2000-C Desert Hydrotest Project

IV. PROJECT COSTS

A. Cost Avoidance Actions

SoCalGas and SDG&E exercised due diligence in the planning, design, and construction activities for this project to minimize or avoid costs when prudent to do so. As discussed above, the Project Team conducted a site visit to identify and incorporate discernible site conditions into the engineering, design, and planning of the Project. Specific examples of cost avoidance actions taken on this project are:

1. Construction Execution: Two of the four hydrotests were within 700 feet of each other, that allowed water storage for the two tests to be shared by building a lake tank at the west end of the two hydrotests, and filling activities happened concurrently by building temporary piping between the two sections to pass water through from one section to the next. Water transportation costs and costs for an additional laydown area to place water storage tanks were avoided.
2. Future Maintenance: As discussed above, an existing tap valve configuration at Indian Canyon Road was relocated in anticipation of a future road expansion project that would have left the existing configuration in the middle of the new road. Costs avoided include future isolation work and repaving.
3. Materials: The Project Team reused test heads from another project versus fabricating new test heads. This was a cost savings on Material, Labor, and Schedule for fabrication and testing of new test heads.

Pipeline Safety Enhancement Plan Final Report
Line 2000-C Desert Hydrotest Project

B. Cost Estimate

Based on the preliminary design, once the project scope was confirmed and engineering, design, and planning activities were underway, SoCalGas and SDG&E prepared an estimate of the Direct Costs of the Project in the amount of \$14,996,378. This estimate was prepared in March of 2016, using the “SCG Pipeline Estimate Template Rev 4” estimating tool, the most current version of the PSEP Estimate Template at the time. The Project Team considered the conditions known at the time to prepare the preliminary Direct Cost estimate. This estimate reflects the projected Labor, Material, and Services costs anticipated to be incurred to execute the Project.

SoCalGas and SDG&E estimated Indirect Costs of the Project based on the estimated Direct Costs and other project-related variables.

C. Actual Direct and Indirect Costs

Actual Direct Costs reflect the Labor, Material and Service costs incurred to execute the Project. Actual Indirect Costs reflect costs for incremental overhead loaders in accordance with Company overhead allocation policies. The total loaded cost of the Project is \$13,952,619.

Pipeline Safety Enhancement Plan Final Report
Line 2000-C Desert Hydrotest Project

Table 4: Estimated and Actual Direct Costs and Variances

Direct Costs (\$)	Estimate	Actuals	Delta Over/(Under)
Company Labor	603,967	606,558	2,591
Materials	1,181,871	290,438	(891,433)
Construction Contractor	6,843,788	5,670,350	(1,173,438)
Construction Management & Support	754,209	1,252,941	498,732
Environmental	1,847,196	2,015,526	168,330
Engineering & Design	1,432,790	1,038,549	(394,241)
Project Management & Services	298,838	265,570	(33,268)
ROW & Permits	343,588	186,475	(157,113)
GMA	1,690,131	1,458,103	(232,028)
Total Direct Costs	14,996,378	12,784,510	(2,211,868)

Table 5: Estimated and Actual Indirect Costs, Total Costs, and Variances

Indirect Costs/Total Costs (\$)	Estimate	Actuals	Delta Over/(Under)
Overheads	960,369	1,092,395	132,026
AFUDC	136,108	66,551	(69,557)
Property Taxes	32,284	9,163	(23,121)
Total Indirect Costs	1,128,761	1,168,109	39,348
Total Direct Costs	14,996,378	12,784,510	(2,211,868)
Total Loaded Costs	16,125,139	13,952,619	(2,172,520)

D. Disallowance

There was no disallowance for Line 2000-C Desert Hydrotest as there were no post-1955 segments included in the Project without records that provide the minimum information to demonstrate compliance with then applicable industry standards or regulatory strength testing and recordkeeping requirements.

Pipeline Safety Enhancement Plan Final Report
Line 2000-C Desert Hydrotest Project

V. CONCLUSION

SoCalGas and SDG&E enhanced the safety of their integrated natural gas transmission system by prudently executing the Line 2000-C Desert Hydrotest Project. Through this Hydrotest Project, SoCalGas and SDG&E hydrotested 7.585 miles in four separate hydrotests, removed a wrinkle bend, and conducted repairs after a test failure, successfully returning the line into service. The total loaded cost of the Project is \$13,952,619.

SoCalGas and SDG&E executed this project prudently by engaging in scope validation efforts that reduced project mileage, siting test end and work site locations to minimize the impact on environmentally sensitive species, responding to numerous unanticipated field conditions, and mitigated unknown irregularities in the pipe, such that all final pressure tests were completed successfully.

SoCalGas and SDG&E engaged in prudent cost avoidance efforts by overall scope validation efforts to reduce Category 4 mileage, taking into consideration future road expansion work in the area, coordinating the use of water, and reusing test heads to complete the safety enhancement work as soon as practicable.

Not only did SoCalGas and SDG&E enhance the safety of their integrated natural gas transmission system by prudently executing the Line 2000-C Desert Hydrotest Project, but more importantly, exposed a defect in the line while hydrotesting it in a safe and controlled environment, avoiding the potential of a rupture during normal operations.

End of Line 2000-C Desert Hydrotest Final Report

Pipeline Enhancement Safety Plan Final Report
Line 2001 West B Sections 17, 18, and 19 Hydrotest Project

I. LINE 2001 WEST B SECTIONS 17, 18, AND 19 HYDROTEST PROJECT

A. Background and Summary

Line 2001 West is a [REDACTED] diameter transmission line that runs approximately 146 miles east of Indio to the City of Rosemead. The line is primarily routed across a Class 3 location. This report describes the activities associated with Line 2001 West B Sections 17, 18, and 19 Hydrotest Project, that consists of the hydrotest of 1.800 miles of pipeline in the City of Industry and La Puente. The specific attributes of this Project are detailed in Table 1 below. The total loaded cost of the Project is \$5,116,684.

The Line 2001 West B Sections 17, 18, and 19 Hydrotest Project is a component of Line 2001 West, that was identified in the 2011 PSEP filing¹ as a 64.100 mile Hydrotest Project. The pipeline is located in the cities of Indio, Whitewater, and Rosemead. For project manageability purposes and due to unique characteristics related to non-contiguous portions of the pipeline, SoCalGas and SDG&E divided the Line 2001 West filing into project sections² to be executed and managed individually. This report summarizes activity and actual costs related to Line 2001 West B Sections 17, 18, and 19 only.

¹ See Amended PSEP of SoCalGas and SDG&E, submitted December 2, 2011, in R.11-02-019 and subsequently transferred to A.11-11-002.

² Line 2001 West A (Sections 15 and 16), Line 2001 West B (Sections 10, 11 and 14), Line 2001 West B (17, 18, and 19), and Line 2001 West C (Sections 1 through 9)

Pipeline Enhancement Safety Plan Final Report
Line 2001 West B Sections 17, 18, and 19 Hydrotest Project

SoCalGas and SDGE presented two separate projects, Line 2001 West A (Sections 15 and 16)³ and Line 2001 West B (Sections 10, 11 and 14)⁴, in its 2016 Reasonableness Review Application. This Project, Line 2001 West B Sections 17, 18, and 19, is located within an area populated by residences, commercial businesses, major public facilities, main arterial thoroughfares, a canal crossing, and a railroad crossing. Although the sections of this Project are short segments (less than 200 feet combined), for constructability and safety reasons, this Project subsumed all three sections into one hydrotest, and included approximately 1.7 miles of Accelerated mileage in the hydrotest.

Table 1: General Project Information

Project Name	Line 2001 West B Sections 17, 18, and 19		
Project Type	Hydrotest		
Length	1.800 miles		
Location	City of Industry and La Puente		
Class	3		
MAOP (<i>confidential</i>)	██████████		
Pipe Vintage	1952		
Construction Start	08/03/2015		
Construction Finish	11/10/2015		
Original Pipe Diameter (<i>confidential</i>)	██████████		
New Diameter (<i>confidential</i>)	N/A		
Original SMYS ⁵ (<i>confidential</i>)	██████████		
New SMYS (<i>confidential</i>)	██████████		
Project Costs (\$)	Capital	O&M	Total
Loaded Project Costs	686,232	4,430,452	5,116,684
Disallowed Costs	-	4,690	4,690

³ Line 2001 West A Replacement Project was submitted for reasonableness review as a workpaper (WP-III-99) in A.16-09-09-005.

⁴ Line 2001 West B Sections 10, 11 & 14 Replacement and Hydrotest Project for reasonableness review as a workpaper (WP-III-111) in A.16-09-09-005.

⁵ Highest percentage of Specified Minimum Yield Strength (SMYS) of Category 4 Criteria pipe.

Pipeline Enhancement Safety Plan Final Report
Line 2001 West B Sections 17, 18, and 19 Hydrotest Project

B. Maps and Images

Figure 1: Satellite Image of Line 2001 West B Sections 17, 18, and 19 Hydrotest Project

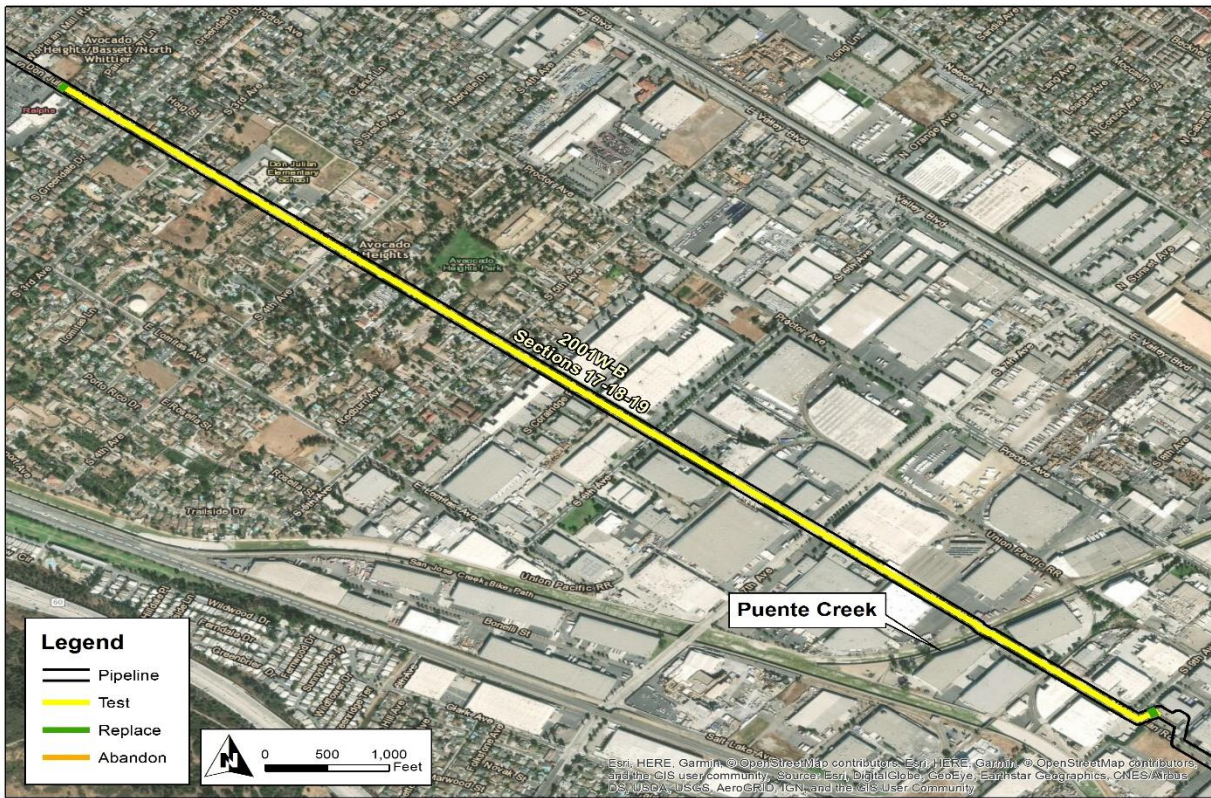

Pipeline Enhancement Safety Plan Final Report
Line 2001 West B Sections 17, 18, and 19 Hydrotest Project

Figure 2: Overview Map of Line 2001 West B Sections 17, 18, and 19 Hydrotest Project

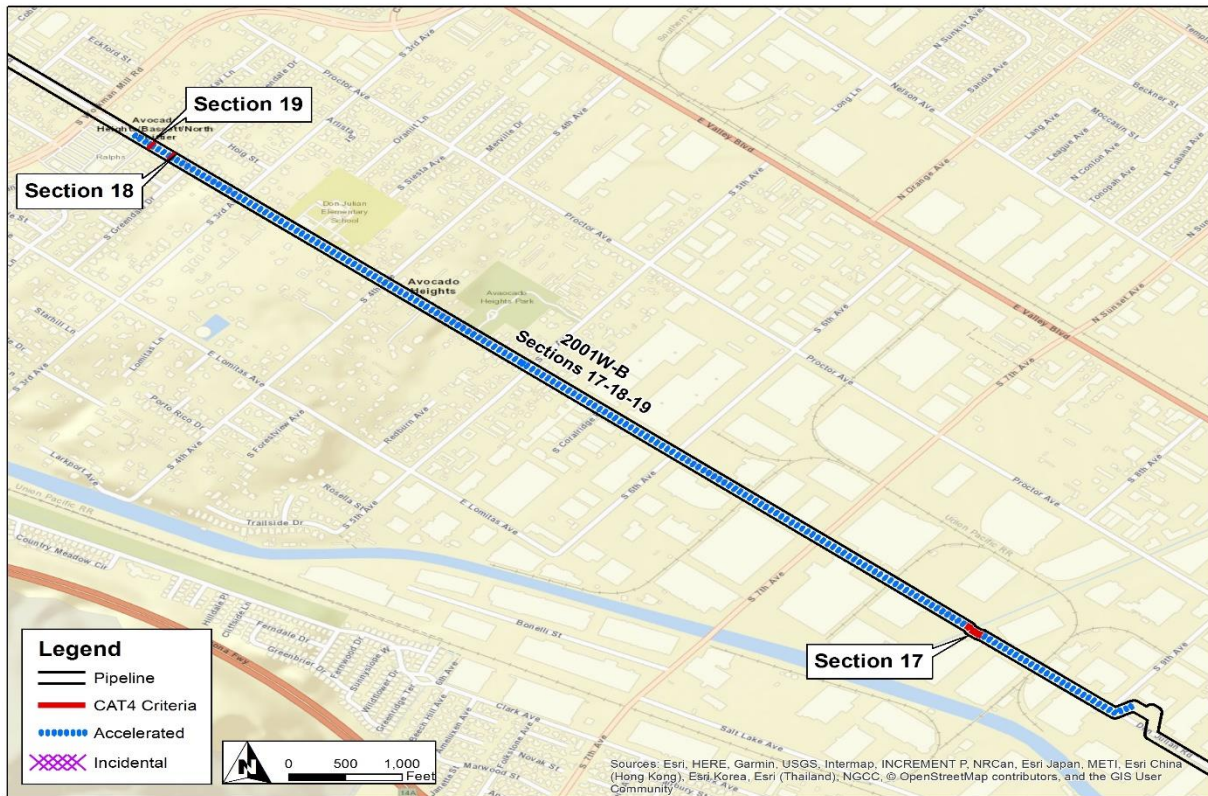

Pipeline Enhancement Safety Plan Final Report
Line 2001 West B Sections 17, 18, and 19 Hydrotest Project

II. ENGINEERING, DESIGN, AND PLANNING

A. Project Scope

Table 2: Mileage Information

	Criteria	Accelerated ⁶	Incidental	Total ⁷
Final Mileage	0.032 mi.	1.769 mi.	0 mi.	1.800 mi
	167 ft.	9,338 ft.	0 ft.	9,505 ft.

SoCalGas and SDG&E presented a conceptual project scope in workpapers supporting the 2011 PSEP filing. Prior to initiating execution of the Project in 2015, SoCalGas and SDG&E reviewed existing pipeline records to validate the scope of the Project. During the Engineering, Design and Planning phase, SoCalGas and SDG&E further refined the scope. This progression of the project scope is summarized as follows:

1. 2011 PSEP Filing: SoCalGas and SDG&E identified Line 2001 West as a Phase 1A Hydrotest Project comprised of 15.809 miles of Category 4 Criteria pipe and 48.291 Accelerated pipe.
2. Scope Validation: Through scope validation activities, after the 2011 filing and before initiating execution of the Project, SoCalGas and SDG&E successfully reduced the scope of the Project by 11.172 miles of Category 4 Criteria pipe for all Project sections.

⁶ Accelerated mileage includes Phase 2B pipe. Phase 2B includes pipelines without record of a pressure test to modern – Subpart J – standards (Phase 2B). The Accelerated mileage was included to realize efficiencies and to enhance project constructability.

⁷ Values may not add to total due to rounding.

Pipeline Enhancement Safety Plan Final Report
Line 2001 West B Sections 17, 18, and 19 Hydrotest Project

3. Engineering, Design and Constructability:
 - a. Based on continued scope validation efforts and detailed planning, the Project Team decided to separate Line 2001 West Projects into Line 2001 West A (Sections 15 and 16), Line 2001 West B (Sections 10, 11, 14, 17, 18, and 19), and Line 2001 West C (Sections 1 through 9) for constructability purposes.
 - b. The Project Team then further split Line 2001 West B during detailed design. Sections 10 and 11 were completed as two hydrotest projects, and Section 14 was completed as a replacement project. The Project Team rescoped the remaining Sections 17, 18, and 19 as three short segment replacement projects.
 - c. Due to difficulties obtaining access rights to the adjacent properties and concern that the jack and bore drilling could undermine the integrity of the La Puente River Bridge, the Project Team decided to combine all three sections into one hydrotest.
4. Final Project Scope: The final project scope consists of a 1.800 mile hydrotest. The Accelerated mileage consists of 1.769 miles of Phase 2B pipe and no Incidental pipe.

Pipeline Enhancement Safety Plan Final Report
Line 2001 West B Sections 17, 18, and 19 Hydrotest Project

B. Decision Tree Analysis

SoCalGas and SDG&E performed a PSEP Decision Tree analysis of Line 2001 West B Sections 17, 18, and 19 and initially confirmed the project design should commence as a Replacement Project.

Segments of less than 1,000 feet are identified for replacement under the approved PSEP Decision Tree because, for short segments of pipe, the logistical costs associated with pressure testing (for example, permitting, construction, water handling, and service disruptions for a non-looped system) can approach or exceed the cost of replacement. In such circumstances, replacement affords a more cost-effective approach to achieving compliance with D.11-06-017 while providing equal safety enhancement benefits. Moreover, installation of the new segment can usually be performed while the existing service is maintained to customers, thereby avoiding service disruptions that may otherwise occur during pressure testing.

Through this Decision Tree analysis, SoCalGas and SDG&E initially identified replacement as the more prudent option. Key considerations that support SoCalGas and SDG&E's ultimate determination to pressure test this segment include:

1. Piggability: Piggable.
2. Pipe Vintage: 1952.
3. Longseam Type: Unknown.

Pipeline Enhancement Safety Plan Final Report
Line 2001 West B Sections 17, 18, and 19 Hydrotest Project

4. Site Observations:

- a. The Project Team observed that a portion of Section 17 is located between two structural piers underneath La Puente Creek. Replacement would require jack and bore installation.
- b. The Project Team identified no major site observations or constructability issues for Sections 18 and 19.

5. Constructability:

- a. The Project Team determined that execution of the replacement of Section 17 using jack and bore between the two structural piers beneath the La Puente Creek, would pose risks and could potentially jeopardize the structural integrity of the bridge supports.
- b. Construction activity associated with a replacement would require temporary right of entry (TRE) agreements with adjacent property owners. SoCalGas and SDG&E were unable to successfully negotiate terms with all the affected property owners.
- c. In consideration of these factors, combined with additional review of pipeline attributes and historical maintenance information, and identifying the mitigation needed to safely pressure test this pipe, the engineering and design process began anew as a hydrotest, in order to achieve PSEP's goal of validating the safety of the pipeline.

As planning and design progressed, SoCalGas and SDG&E determined that hydrotesting would be the most prudent option when land access issues and design constraints became evident as explained above. The Project Team changed its recommendation to instead combine all three sections into one hydrotest project.

Pipeline Enhancement Safety Plan Final Report
Line 2001 West B Sections 17, 18, and 19 Hydrotest Project

C. Engineering, Design, and Planning Factors

SoCalGas and SDG&E reviewed pipeline drawings and other information, contacted internal planning groups, communicated with external stakeholders, conducted survey activity, including reviewing public records and potholing of the area to confirm the presence of underground utilities and substructures, and completed a pre-design site walk. Key factors that influenced the engineering and design of the Project are as follows:

1. Shut-in Analysis: The Project Team completed a Request for Engineering Review (RER) analysis and concluded that the two main distribution systems, Supply Line 31-08 and Supply Line 44-137, are bridled and can be shut in between the two mainline valves (MLVs) with minimal impacts to customers.
2. Environmental:
 - a. Review of Section 17 identified indirect or direct impacts to special status species, including species listed under the California and Federal Endangered Species Acts, or their habitats, which would lead to discussions with California Department of Fish and Wildlife (CDFW), United States Fish and Wildlife Service (USFWS), and/or other agencies. Permitting efforts were estimated to range from 6 to 18 months before approval is granted.
 - b. Coordination and permits with CDFW, Regional Water Quality Control Board (RWQCB), or United States Army Corps of Engineers (USACE) would have been required for boring underneath the La Puente Creek concrete channel on Section 17. Permitting efforts were estimated to range from 6 to 12 months before approval is granted.

Pipeline Enhancement Safety Plan Final Report
Line 2001 West B Sections 17, 18, and 19 Hydrotest Project

D. Scope Changes

Through engineering, design, and planning activities, SoCalGas and SDG&E determined that changes in scope were appropriate to enhance the design of the Project and address engineering factors. As a result, the preliminary cost estimate does not fully reflect the final scope. Summarized below are notable changes in scope made after the preliminary cost estimate was developed and approved.

1. Initial scope included Sections 10, 11, 14, 17, 18, and 19 as one project. The Project Team completed Sections 10, 11, and 14 in 2016, and submitted them for reasonableness review in A.16-09-005.⁸ The remaining replacement Sections 17, 18, and 19 were separated for a later filing.
2. The Project Team revised the scope of Section 17, 18, and 19 from three separate replacement sections into one hydrotest section.

⁸ See WP-III-A111.

Pipeline Enhancement Safety Plan Final Report
Line 2001 West B Sections 17, 18, and 19 Hydrotest Project

III. CONSTRUCTION

A. Construction Contractor Selection

The Project Team prepared an initial cost estimate based on the preliminary design. Following completion of the engineering, design and planning activities described above, the Project Team directed the Performance Partner to prepare cost estimates based on a more detailed engineering design package, which included the updated design described in the discussion of notable Scope Changes above. SoCalGas and SDG&E awarded the construction contract to the Performance Partner.

1. SoCalGas and SDG&E’s Preliminary Construction Cost Estimate (based on Replacement) (confidential): SoCalGas and SDG&E’s preliminary cost estimate for construction was [REDACTED].
2. Construction Contractor’s Target Price Estimate (confidential): The Construction Contractor’s construction cost estimate was [REDACTED], which was [REDACTED] than SoCalGas and SDG&E’s preliminary cost estimate for construction.

B. Construction Schedule

Table 3: Construction Timeline

Construction Start Date	08/03/2015
Construction Completion Date	11/10/2015
NOP Date	09/30/2015

C. Changes During Construction

The conditions summarized below were encountered during construction. Activities to address or mitigate these conditions resulted in approximately \$270,000 in change orders.

Pipeline Enhancement Safety Plan Final Report
Line 2001 West B Sections 17, 18, and 19 Hydrotest Project

1. Equipment Needs: Bending shoes and bending machine was required for the west test end tie-in piece, as the Project Team identified a five-degree bend once the pipe was exposed and a segment was removed in preparation for the hydrotest. This work was required to allow for proper fit-up and tie-in once the Construction Contractor completed the hydrotest.
2. Site Conditions:
 - a. As part of SoCalGas and SDG&E's bell hole inspection practice, the Construction Contractor removed the two end point pieces, sandblasted, and further inspected the pipe. In doing so, the Construction Contractor identified imperfections/defects on the pipe, and repairs were required. To conduct the repairs, the Project Team decided to extend the excavation limits that required additional abatement of coal tar wrap.
 - b. Post construction, the Project Team identified damage to the concrete parking lot that was used as the construction laydown yard and staging area. The Construction Contractor removed and replaced three 9 foot by 10 foot concrete pads.
3. Tie-in: Initial estimate assumed a 16 hour day to complete the final tie-in at both ends for the Project.
4. Traffic Control: The Project Team requested an additional traffic control aid to help facilitate dewatering and waste removal from the water storage tanks after hydrotest completion.
5. Water management: The Project Team requested additional water management to assist the hydrotest contractor with dewatering and drying the pipeline after the hydrotest was complete.

Pipeline Enhancement Safety Plan Final Report
Line 2001 West B Sections 17, 18, and 19 Hydrotest Project

6. Work Hours: Planned work hours were originally five days per week, eight hours per day, but due to various schedule delays, the Project Team revised work hours towards the end of construction to meet the planned demobilization date.

Pipeline Enhancement Safety Plan Final Report
Line 2001 West B Sections 17, 18, and 19 Hydrotest Project

Figure 3: K-Rail Set Up Along Don Julian Road



Pipeline Enhancement Safety Plan Final Report
Line 2001 West B Sections 17, 18, and 19 Hydrotest Project

Figure 4: Water Storage Tanks for Hydrotest



Pipeline Enhancement Safety Plan Final Report
Line 2001 West B Sections 17, 18, and 19 Hydrotest Project

Figure 5: Preparation of Bell Hole for Coating Abatement



Pipeline Enhancement Safety Plan Final Report
Line 2001 West B Sections 17, 18, and 19 Hydrotest Project

Figure 6: Poly Pig Removal from Test Head



Pipeline Enhancement Safety Plan Final Report
Line 2001 West B Sections 17, 18, and 19 Hydrotest Project

Figure 7: Off-loading Pig Launcher
(used for launching multiple pigs for post hydrotest line drying)



Pipeline Enhancement Safety Plan Final Report Line 2001 West B Sections 17, 18, and 19 Hydrotest Project

Figure 8: Excavation Backfill with Slurry and Warning Mesh



Pipeline Enhancement Safety Plan Final Report
Line 2001 West B Sections 17, 18, and 19 Hydrotest Project

D. Commissioning and Site Restoration

Commissioning activities include restoration of the site, final inspection and placement of the pipeline back into service, transportation and disposal of hydrotested water and hazardous material, and site demobilization. Closeout activities include development of final drawings, finalization of a reconciliation package, and updates to company recordkeeping systems to reflect the completed scope of work.

Pipeline Enhancement Safety Plan Final Report
Line 2001 West B Sections 17, 18, and 19 Hydrotest Project

IV. PROJECT COSTS

A. Cost Avoidance Actions

SoCalGas and SDG&E exercised due diligence in the planning, design, and construction activities for this project to minimize or avoid costs when prudent to do so. As discussed above, the Project Team conducted a site visit to identify and incorporate discernible site conditions into the engineering, design and planning of the Project. A specific example of cost avoidance actions taken on this project was the reuse of test heads from another Project versus fabricating new test heads. This was a cost savings on material and labor for fabrication and testing of new test heads.

B. Cost Estimate

Based on the preliminary design, once the project scope was confirmed and engineering, design and planning activities were underway, SoCalGas and SDG&E prepared an estimate of the Direct Costs of the Project in the amount of \$2,212,603. This estimate was prepared in January of 2015, using the “SCG Pipeline Estimate Template Rev 0” estimating tool, the most current version of the PSEP Estimate Template at the time. The Project Team considered the conditions known at the time to prepare the preliminary Direct Cost estimate. This estimate reflects the projected Labor, Material, and Services costs anticipated to be incurred to execute the Project.

SoCalGas and SDG&E estimated Indirect Costs of the Project based on the estimated Direct Costs and other project related variables.

Pipeline Enhancement Safety Plan Final Report
Line 2001 West B Sections 17, 18, and 19 Hydrotest Project

C. Actual Direct and Indirect Costs

Actual Direct Costs reflect the Labor, Material, and Service costs incurred to execute the Project. Actual Indirect Costs reflect costs for incremental overhead loaders in accordance with Company overhead allocation policies. The total loaded cost of the Project is \$5,116,684.

Table 4: Estimated and Actual Direct Costs and Variances

Direct Costs (\$)	Estimate	Actuals	Delta Over/(Under)
Company Labor	173,463	272,469	99,006
Materials	206,333	29,735	(176,598)
Construction Contractor	857,805	899,707	41,902
Construction Management & Support	136,911	570,435	433,524
Environmental	195,800	449,202	253,402
Engineering & Design	291,626	1,544,232	1,252,606
Project Management & Services	104,163	371,839	267,676
ROW & Permits	12,650	54,163	41,513
GMA	233,852	560,482	326,630
Total Direct Costs	2,212,603	4,752,264	2,539,661

Table 5: Estimated and Actual Indirect Costs, Total Costs, and Variances

Indirect Costs/Total Costs (\$)	Estimate	Actuals	Delta Over/(Under)
Overheads	261,624	360,006	98,382
AFUDC	6,287	-	(6,287)
Property Taxes	1,305	4,414	3,109
Total Indirect Costs	269,216	364,420	95,204
Total Direct Costs	2,212,603	4,752,264	2,539,661
Total Loaded Costs	2,481,819	5,116,684	2,634,865

Pipeline Enhancement Safety Plan Final Report
Line 2001 West B Sections 17, 18, and 19 Hydrotest Project

D. Disallowance

For this Hydrotest Project, SoCalGas and SDG&E identified a total of 10 feet of pipe as being installed post-1955 and lacking pressure test records that provide the minimum information to demonstrate compliance with industry standards or then-applicable strength testing and recordkeeping requirements. Of the 1.789 miles of pipeline that were pressure tested, 10 feet (0.11%) of test mileage are disallowed, therefore \$4,690 of total project O&M costs are disallowed from recovery.

Pipeline Enhancement Safety Plan Final Report
Line 2001 West B Sections 17, 18, and 19 Hydrotest Project

V. CONCLUSION

SoCalGas and SDG&E enhanced the safety of their integrated natural gas transmission system by prudently executing the Line 2001 West B Sections 17,18, and 19 Hydrotest Project. Through this Hydrotest Project, SoCalGas and SDG&E successfully hydrotested 1.800 miles of pipeline in the City of Industry and La Puente. The total loaded cost of the Project is \$5,116,684.

SoCalGas and SDG&E executed the Project prudently through the scoping of Line 2001 West into four projects to align the Category 4 Criteria pipeline with their geographical proximity; and then further scoped Section B into four distinct projects to capture project management efficiencies and resolve constructability issues. While Sections 17, 18, and 19 were originally envisioned as replacement projects due to the very short length of each Category 4 Criteria segment, the Project Team ultimately decided to hydrotest these segments when negotiations with impacted land owners reached an impasse and the complexities of safely engineering a replacement design around bridge supports became imprudent.

SoCalGas and SDG&E engaged in prudent cost avoidance efforts by engaging in scope validation efforts that reduced project mileage, reusing test heads versus fabricating new ones, and responding to numerous unanticipated field conditions. These include unanticipated equipment needs and imperfections and defects identified during bell hole inspections that required repairs.

End of Line 2001 West B Sections 17, 18, and 19 Hydrotest Project Final Report

Pipeline Safety Enhancement Plan Final Report
Line 2003 Section 2 Hydrotest Project

I. LINE 2003 SECTION 2 HYDROTEST PROJECT

A. Background and Summary

Line 2003 is a [REDACTED] diameter transmission line that runs approximately 26 miles from East Slauson Avenue in Downey to Mississippi Avenue in the City of Los Angeles. The Line 2003 Section 2 Hydrotest Project is located approximately 1.5 miles away from the Los Angeles World Airports (LAX), within the intersection at La Cienega Boulevard and 104th Street. The pipeline is primarily routed across a Class 3 location. This report describes the activities associated with the Line 2003 Section 2 Hydrotest Project that consists of the hydrotest of 447 feet and abandonment and replacement of 47 feet for a total of 494 feet of remediated pipeline. The specific attributes of this Project are detailed in Table 1 below. The total loaded cost of the Project is \$2,927,081.

The Line 2003 Section 2 Hydrotest Project is a component of Line 2003, that was identified in the 2011 PSEP filing as a 26.500 mile Hydrotest project. The pipeline is located in the cities of Los Angeles, Pico Rivera, and Downey. For project manageability purposes and due to unique characteristics related to non-contiguous portions of the pipeline, SoCalGas and SDG&E divided the Line 2003 project into sections to be executed and managed individually. This report summarizes activity and actual costs related to Section 2 only.

Pipeline Safety Enhancement Plan Final Report Line 2003 Section 2 Hydrotest Project

Table 1: General Project Information

Project Name	Line 2003 Section 2		
Project Type	Hydrotest		
Length	494 feet		
Location	Inglewood & City of Los Angeles, County of Los Angeles		
Class	3		
MAOP (<i>confidential</i>)	██████████		
Pipe Vintage	1957		
Construction Start	07/13/2015		
Construction Finish	08/31/2015		
Original Pipe Diameter (<i>confidential</i>)	██████████		
New Diameter (<i>confidential</i>)	N/A		
Original SMYS ¹ (<i>confidential</i>)	██████████		
New SMYS (<i>confidential</i>)	N/A		
Project Costs (\$)	Capital	O&M	Total
Loaded Project Costs	487,965	2,439,116	2,927,081
Disallowed Costs	-	311,028	311,028

¹ Highest percentage of Specified Minimum Yield Strength (SMYS) of Category 4 Criteria pipe.

Pipeline Safety Enhancement Plan Final Report
Line 2003 Section 2 Hydrotest Project

B. Maps and Images

Figure 1: Satellite Image of Line 2003 Section 2 Hydrotest Project

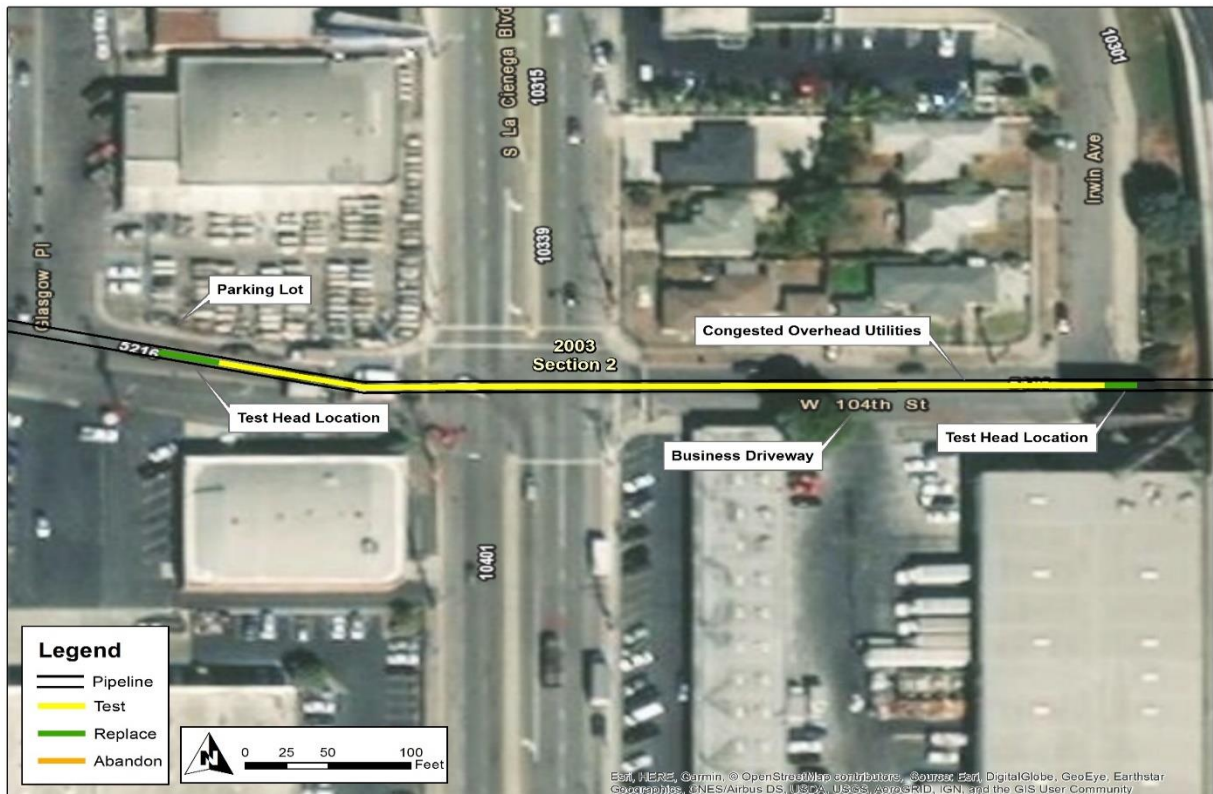

Pipeline Safety Enhancement Plan Final Report Line 2003 Section 2 Hydrotest Project

Figure 2: Overview Map of Line 2003 Section 2 Hydrotest Project

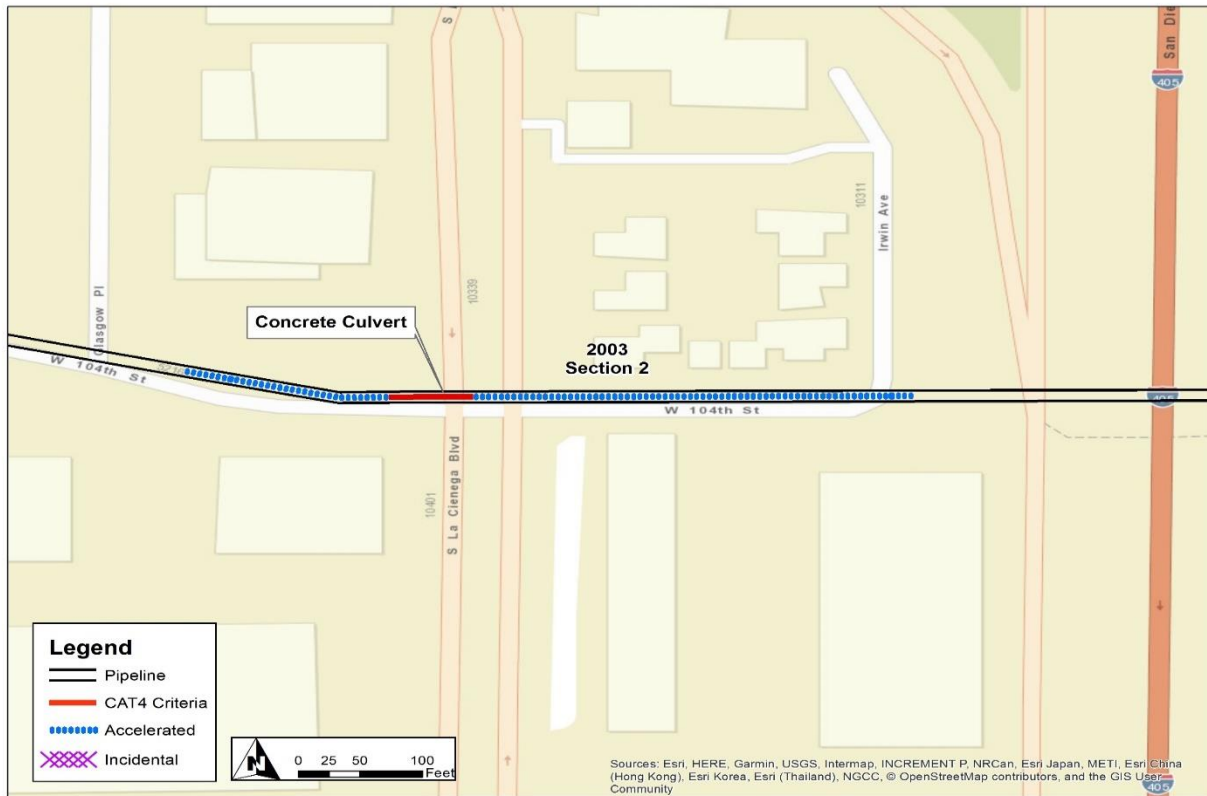

Pipeline Safety Enhancement Plan Final Report
Line 2003 Section 2 Hydrotest Project

II. ENGINEERING, DESIGN, AND PLANNING

A. Project Scope

Table 2: Mileage Information

	Criteria	Accelerated ²	Incidental	Total ³
Final Mileage	0.011 mi.	0.083 mi.	0 mi.	0.094 mi.
	57 ft.	437 ft.	0 ft.	494 ft.

SoCalGas and SDG&E presented a conceptual project scope in workpapers supporting the 2011 PSEP filing⁴. Prior to initiating execution of the Project in 2015, SoCalGas and SDG&E reviewed existing pipeline records to validate the scope of the Project. During the Engineering, Design, and Planning phase, SoCalGas and SDG&E further refined the scope. This progression of the project scope is summarized as follows:

1. 2011 PSEP Filing: SoCalGas and SDG&E identified Line 2003 as a Phase 1A Hydrotest Project comprised of 26.225 miles of Category 4 Criteria pipe and 0.275 miles of Accelerated pipe.
2. Scope Validation: Through scope validation activities, after the 2011 filing and before initiating execution of the Project, SoCalGas and SDG&E successfully reduced the scope of the Project by 26.087 miles of Category 4 Criteria pipe for all Project sections.

² Accelerated mileage includes Phase 2B pipe. Phase 2B includes pipelines without record of a pressure test to modern – Subpart J – standards (Phase 2B). The Accelerated mileage was included to realize efficiencies and to enhance project constructability.

³ Values may not add to total due to rounding.

⁴ See Amended PSEP of SoCalGas and SDG&E, submitted December 2, 2011, in R.11-02-019 and subsequently transferred to A.11-11-002.

Pipeline Safety Enhancement Plan Final Report
Line 2003 Section 2 Hydrotest Project

3. Engineering, Design, and Constructability: Due to its location in a highly congested area, both above and below-grade, and for constructability reasons, the Project Team moved the tie-in locations out of the intersection, thus adding incremental feet to the Hydrotest Project.
4. Final Project Scope: The final project scope consists of a 494 foot Hydrotest. The Accelerated mileage consists of 437 feet of Phase 2B pipe.

B. Decision Tree Analysis

SoCalGas and SDG&E performed a PSEP Decision Tree analysis of Line 2003 Section 2 and initially confirmed the project design should commence as a Replacement Project.

Segments of less than 1,000 feet are identified for replacement under the approved PSEP Decision Tree because, for short segments of pipe, the logistical costs associated with pressure testing (for example, permitting, construction, water handling, and service disruptions for a non-looped system) can approach or exceed the cost of replacement. In such circumstances, replacement affords a more cost-effective approach to achieving compliance with D.11-06-017 while providing equal safety enhancement benefits. Moreover, installation of the new segment can usually be performed while the existing service is maintained to customers, thereby avoiding service disruptions that may otherwise occur during pressure testing.

Through this Decision Tree analysis, SoCalGas and SDG&E initially identified replacement as the more prudent option.

Pipeline Safety Enhancement Plan Final Report
Line 2003 Section 2 Hydrotest Project

However, as the Project progressed, the Project Team recognized that the Category 4 Criteria mileage segment to be addressed had above and below-grade impediments, jurisdictional constraints (between Los Angeles County and City of Los Angeles), and efforts to secure a temporary right of entry (TRE) for a jack and bore met with challenges that extended the schedule and would increase costs. Due to these complexities associated with jack and bore, and because the line was piggable, the Project Team determined a hydrotest of this section was the appropriate action, that achieved the PSEP objectives and minimized impacts to nearby residences and businesses. Key considerations that support SoCalGas and SDG&E's determination to pressure test this segment include:

1. Community Impact:

- a. Section 2 is within a busy street intersection (La Cienega Boulevard and 104th Street). Due to its location and utility congestion both overhead and buried below grade, hydrotesting was determined to be a less intrusive option, minimizing impacts to customers and the community. Historical documents also showed that the Category 4 Criteria mileage segment is located underneath a 13 by 9 foot concrete culvert about 25 feet below grade.
- b. The original Decision Tree Analysis recommendation was to replace per the Decision Tree. However, during engineering, design, and planning, the magnitude of customer and community impact, above and below grade infrastructures, and jurisdictional constraints (as explained above), the Project Team changed the recommendation to a hydrotest. The previous In Line Inspection (ILI) assessment indicated hydrotesting this pipe was a feasible option.

Pipeline Safety Enhancement Plan Final Report
Line 2003 Section 2 Hydrotest Project

2. Piggability: Piggable.
3. Pipe Vintage: 1957.
4. Community Impact: The replacement option would have required excavation that would negatively impact access to the local businesses and community. The hydrotest option would minimize these impacts to the local community and businesses.
5. Site Observations:
 - a. The Category 4 Criteria mileage section is located at the intersection of La Cienega Boulevard and 104th Street, an arterial thoroughfare to Interstate 405. There is consistent heavy traffic along La Cienega Boulevard (four lane road with left turn pockets and a concrete median), and 104th is a two-lane road with light traffic east of La Cienega Boulevard and R of Way (ROW), Interstate 405. Traffic control was deemed critical for this design.
 - b. The location is made up of a mix of residential and industrial.
 - c. The underground and overhead areas are congested with buried and overhead utilities, limiting potential bore pit locations.
 - d. An open cut trench across La Cienega Boulevard for the replacement option would have been limited in length during construction, and the Project Team would have had to execute the project in phases in order to minimize traffic impacts.

Pipeline Safety Enhancement Plan Final Report
Line 2003 Section 2 Hydrotest Project

C. Engineering, Design, and Planning Factors

SoCalGas and SDG&E reviewed pipeline drawings and other information, contacted internal planning groups, communicated with external stakeholders, conducted survey activities, including reviewing public records and potholing of the area to confirm the presence of underground utilities and substructures, and completed a pre-design site walk. Key factors that influenced the engineering and design of the Project are as follows:

1. Shut-in Analysis: The Project Team completed a Request for Engineering Review (RER) analysis and concluded the line could be shut-in during peak winter and summer conditions. The shut-in was also coordinated with the PSEP Supply Line 37-07 Replacement Project.
2. Customer Impact: No customer interruption of service was anticipated as work was planned for summer conditions. However, as noted above, construction would impact traffic on this highly traveled thoroughfare.
3. Resource Coordination: Shared laydown yard with the PSEP Line 2003 Section 3 Project.
4. Permit Restrictions: Permits were required from the City of Los Angeles Bureau of Engineering (BOE), Los Angeles County, and the Los Angeles County permit was dependent on the City of Los Angeles permit. Pothole permits were delayed due to a backlog within the City of Los Angeles BOE permitting process. The pothole permitting delays impacted the schedule and design efforts.

Pipeline Safety Enhancement Plan Final Report Line 2003 Section 2 Hydrotest Project

5. Known Substructures: Historical documents show a 13 foot by 9 foot concrete culvert (where the Category 4 Criteria mileage segment is approximately 25 feet below ground surface, below the culvert). Once potholing was completed after 60% design, the pipeline alignment was adjusted to reflect as-found conditions.
6. Traffic Control: Because the work area would be located at the intersection of an arterial thoroughfare, traffic control was a major factor in project design throughout engineering, design, and planning.
7. Environmental: Abatement activities for coal tar/asbestos were anticipated and accounted for in the estimate; long lead environmental permits were not required.

D. Scope Changes

As described above, the engineering and design plans progressed into preconstruction and the scope of this Project changed from a replacement project using jack and bore construction, to a hydrotest. As a result, the estimate reflects the revised scope.

Pipeline Safety Enhancement Plan Final Report
Line 2003 Section 2 Hydrotest Project

III. CONSTRUCTION

A. Construction Contractor Selection

The Project Team prepared an initial cost estimate based on the preliminary design. Following completion of the engineering, design, and planning activities described above, the Project Team directed the Performance Partner to prepare cost estimates based on a more detailed engineering design package, which included the updated design described in the discussion of notable Scope Changes above. SoCalGas and SDG&E awarded the construction contract to the Performance Partner.

1. SoCalGas and SDG&E’s Preliminary Construction Cost Estimate (*confidential*):
SoCalGas and SDG&E’s preliminary cost estimate for construction was [REDACTED].
2. Construction Contractor’s Target Price Estimate (*confidential*): The Construction Contractor’s cost estimate was [REDACTED], which was [REDACTED] than SoCalGas and SDG&E’s preliminary cost estimate for construction.

B. Construction Schedule

Table 3: Construction Timeline

Construction Start Date	07/13/2015
Construction Completion Date	08/31/2015
NOP Date	08/24/2015

Pipeline Safety Enhancement Plan Final Report
Line 2003 Section 2 Hydrotest Project

C. Changes During Construction

The condition summarized below was encountered during construction. Activities to address or mitigate this condition resulted in approximately \$22,000 in change orders⁵.

1. Constructability Issues: Additional potholing was required to locate substructures in the tie-in area. The Project Team adjusted the transition piping and test head location on the east end to provide the necessary clearance.

⁵ This amount does not include a change order for a rate increase not included in the Contractor's estimate that was not related to activity in the field.

Pipeline Safety Enhancement Plan Final Report
Line 2003 Section 2 Hydrotest Project

D. Commissioning and Site Restoration

Commissioning activities include restoration of the site, final inspection and placement of the pipeline back into service, transportation and disposal of hydrotested water and hazardous material, and site demobilization. Closeout activities include development of final drawings, finalization of a reconciliation package, and updates to company recordkeeping systems to reflect the completed scope of work.

Pipeline Safety Enhancement Plan Final Report
Line 2003 Section 2 Hydrotest Project

IV. PROJECT COSTS

A. Cost Avoidance Actions

SoCalGas and SDG&E exercised due diligence in the planning, design, and construction activities for this project to minimize or avoid costs when prudent to do so. As discussed above, the Project Team conducted a site visit to identify and incorporate discernible site conditions into the engineering, design, and planning of the Project. Specific examples of cost avoidance actions taken on this project are:

1. Materials:
 - a. Bulk ordered pipe provided volume pricing for the [REDACTED] pipe.
 - b. The Project Team also built and reused test heads for all PSEP Line 2003 projects.
2. Land Use: The Project Team shared a laydown yard with the Line 2003 Section 3 Project.
3. Water Management: The Project Team reused water for both this Project and the Line 2003 Section 3 Project. The Project Team originally brought the water for different PSEP projects. The reused water was a cost savings to the Project by avoiding the purchase of water, and the cost of water treatment and/or disposal was shared amongst jobs.

Pipeline Safety Enhancement Plan Final Report
Line 2003 Section 2 Hydrotest Project

B. Cost Estimates

Based on the preliminary design, once the project scope was confirmed and engineering, design, and planning activities were underway, SoCalGas and SDG&E prepared an estimate of the Direct Costs of the Project in the amount of \$2,112,898. This estimate was prepared in March of 2015, using the “SCG Pipeline Estimate Template Rev 0” estimating tool, the most current version of the PSEP Estimate Template at the time. The Project Team considered the conditions known at the time to prepare the preliminary Direct Cost estimate. This estimate reflects the projected Labor, Material, and Services costs anticipated to be incurred to execute the Project.

SoCalGas and SDG&E estimated Indirect Costs of the Project based on the estimated Direct Costs and other project-related variables.

C. Actual Direct and Indirect Costs

Actual Direct Costs reflect the Labor, Material, and Service costs incurred to execute the Project. Actual Indirect Costs reflect costs for incremental overhead loaders in accordance with Company overhead allocation policies. The total loaded cost of the Project is \$2,927,081.

Pipeline Safety Enhancement Plan Final Report
Line 2003 Section 2 Hydrotest Project

Table 4: Estimated and Actual Direct Costs and Variances

Direct Costs (\$)	Estimate	Actuals	Delta Over/(Under)
Company Labor	177,415	121,342	(56,073)
Materials	40,133	35,085	(5,048)
Construction Contractor	1,044,515	1,003,842	(40,673)
Construction Management & Support	76,058	226,172	150,114
Environmental	117,700	115,909	(1,791)
Engineering & Design	301,111	837,482	536,371
Project Management & Services	115,446	42,943	(72,503)
ROW & Permits	15,950	18,320	2,370
GMA	224,570	324,529	99,959
Total Direct Costs	2,112,898	2,725,624	612,726

Table 5: Estimated and Actual Indirect Costs, Total Costs, and Variances

Indirect Costs/Total Costs (\$)	Estimate	Actuals	Delta Over/(Under)
Overheads	164,262	199,506	35,244
AFUDC	3,113	-	(3,113)
Property Taxes	585	1,951	1,366
Total Indirect Costs	167,960	201,457	33,497
Total Direct Costs	2,112,898	2,725,624	612,726
Total Loaded Costs	2,280,858	2,927,081	646,223

D. Disallowance

For this Hydrotest Project, SoCalGas and SDG&E identified a total of 57 feet of pipe as being installed post-1955 and lacking pressure test records that provide the minimum information to demonstrate compliance with industry standards or then-applicable strength testing and recordkeeping requirements. Of the 447 feet of pipeline that were pressure tested, 57 feet (12.75%) of test mileage are disallowed, therefore \$311,028 of total project O&M costs are disallowed from recovery.

Pipeline Safety Enhancement Plan Final Report
Line 2003 Section 2 Hydrotest Project

V. CONCLUSION

SoCalGas and SDG&E enhanced the safety of their integrated natural gas transmission system by prudently executing the Line 2003 Section 2 Hydrotest Project. Through this Hydrotest Project, SoCalGas and SDG&E successfully remediated 494 feet of pipeline in the City of Los Angeles. The total loaded cost of the Project is \$2,927,081.

SoCalGas and SDG&E executed this Project prudently through planning and design by adjusting the pipe alignment placement to avoid an underground concrete culver. The Project Team minimized customer impacts by hydrotesting rather than replacing this short section of pipe. Through schedule coordination with other projects to avoid a disruption of service, the Project Team safely performed a hydrotest on a major thoroughfare, using a combination of internal and Performance Partner construction management to complete the safety enhancement work as soon as practicable.

SoCalGas and SDG&E engaged in prudent cost avoidance efforts by reducing project scope through validation; (e.g., reducing Category 4 Criteria mileage by over 26 miles) working with other PSEP projects to share a laydown yard; reusing of test heads and test water; and saving costs from bulk purchasing.

End of Line 2003 Section 2 Hydrotest Project Final Report

Pipeline Safety Enhancement Plan Final Report
Supply Line 36-9-09 Section 5A Hydrotest and Replacement Project

I. SUPPLY LINE 36-9-09 NORTH SECTION 5A HYDROTEST AND REPLACEMENT PROJECT

A. Background and Summary

Supply Line 36-9-09 North Section 5A is a [REDACTED] diameter transmission line that runs approximately 1.5 miles parallel to the Pacific Ocean through both commercial and residential neighborhoods, including the beach front known as “Hotel Row”, and alongside Highway 101, crossing under Highway 101 from Mattie Road to Bello Street in the City of Pismo Beach. The pipeline is primarily routed across a Class 3 location. This report describes the activity associated with the Supply Line 36-9-09 North Section 5A Hydrotest and Replacement Projects that consists of a hydrotest of 0.572 miles of pipeline and replacement of 0.914 miles of pipeline. The specific attributes of this Project are detailed in Table 1 below. The total loaded cost of the Project is \$14,199,256.

The Supply Line 36-9-09 North Section 5A Hydrotest and Replacement Project is a component of Supply Line 36-9-09-North, that was identified in the 2011 PSEP filing¹ as a 16.016-mile replacement project. The pipeline is located in the cities of Atascadero, San Luis Obispo, Pismo Beach, and Arroyo Grande and is primarily routed across a Class 3 location. For project manageability purposes and due to unique characteristics related to non-contiguous portions of the pipeline, SoCalGas and SDG&E divided Supply Line-36-9-09 North into several project sections to be managed individually (see Figure 1).

¹ See Amended PSEP of SoCalGas and SDG&E, submitted December 2, 2011, in R.11-02-019 and subsequently transferred to A.11-11-002.

Pipeline Safety Enhancement Plan Final Report
Supply Line 36-9-09 Section 5A Hydrotest and Replacement Project

Two key reasons drove the decision to manage the work on Supply Line 36-9-09 North in this manner; the sections were in different locations, and they were physically separated from each other by non-PSEP segments of pipeline. Additionally, project scopes (hydrotesting, replacement or abandonment) differed among the sections that led to differing permit acquisition timelines.

Table 1: General Project Information

Project Name		Supply Line 36-9-09 North Section 5A		
Project Type	Hydrotest and Replacement			
Length	1.493 miles			
Location	Pismo Beach			
Class	3			
MAOP (confidential)	[REDACTED]			
Pipe Vintage	1932 and 1960			
Construction Start	02/08/2016			
Construction Finish	07/22/2016			
Original Pipe Diameter (confidential)	[REDACTED]			
New Diameter (confidential)	[REDACTED]			
Original SMYS ² (confidential)	[REDACTED]			
New SMYS (confidential)	[REDACTED] (for replacement sections)			
Project Costs (\$)	Capital	O&M	Total	
Loaded Project Costs	14,196,758	2,498	14,199,256	
Disallowed Costs	-	-	-	

² Highest percentage of Specified Minimum Yield Strength (SMYS) of Category 4 Criteria pipe.

Pipeline Safety Enhancement Plan Final Report
Supply Line 36-9-09 Section 5A Hydrotest and Replacement Project

B. Maps and Images

Figure 1: Map of Supply Line 36-9-09 North PSEP Projects



Pipeline Safety Enhancement Plan Final Report Supply Line 36-9-09 Section 5A Hydrotest and Replacement Project

Figure 2: Satellite Image of Supply Line 36-9-09 North Section 5A Hydrotest and Replacement Project



Pipeline Safety Enhancement Plan Final Report Supply Line 36-9-09 Section 5A Hydrotest and Replacement Project

Figure 3: Overview Map of Supply Line 36-9-09 North Section 5A Hydrotest and Replacement Project



Pipeline Safety Enhancement Plan Final Report
Supply Line 36-9-09 Section 5A Hydrotest and Replacement Project

II. ENGINEERING, DESIGN, AND PLANNING

A. Project Scope

Table 2: Mileage Information

	Criteria	Accelerated ³	Incidental	New	Total ⁴
Replacement	0.854 mi.	0	0.027 mi.	0.040 mi.	0.921mi.
	4,509 ft.	0	142 ft.	210 ft.	4,861 ft.
Hydrotest	0.358 mi.	0.215 mi.	0	0	0.572 mi.
	1,888 ft.	1,134 ft.	0	0	3,022 ft.
Final Mileage	1.211 mi.	0.215 mi.	0.027 mi.	0.039 mi.	1.493 mi.
	6,397 ft.	1,134 ft.	142 ft.	210 ft.	7,883 ft.

SoCalGas and SDG&E presented a conceptual project scope in workpapers supporting the 2011 PSEP filing. Prior to initiating execution of the Project in 2016, SoCalGas and SDG&E reviewed existing pipeline records to validate the scope of the Project. During the Engineering, Design, and Planning phase, SoCalGas and SDG&E further refined the scope. This progression of the project scope is summarized as follows:

1. 2011 PSEP Filing: SoCalGas and SDG&E identified Supply Line 36-9-09 North as a Phase 1A Replacement project comprised of 9.662 miles of Category 4 Criteria pipe and 6.354 miles of Accelerated pipe. Supply Line 36-9-09 North Section 5A is within that project.
2. Scope Validation: Through scope validation activities, after the 2011 filing and before initiating execution of the Project, SoCalGas and SDG&E successfully reduced the scope of the Project by 8.451 miles of Category 4 Criteria pipe.

³ Accelerated mileage includes Phase 2B pipe. Phase 2B includes pipelines without record of a pressure test to modern – Subpart J – standards (Phase 2B). The Accelerated mileage was included to realize efficiencies and to enhance project constructability.

⁴ Values may not add to total due to rounding.

Pipeline Safety Enhancement Plan Final Report
Supply Line 36-9-09 Section 5A Hydrotest and Replacement Project

3. Engineering, Design, and Constructability:

- a. SoCalGas and SDG&E initially scoped Supply Line 36-9-09 North Section 5A as a portion of a larger project, formerly known as Supply Line 36-9-09 Section 5 Project; however, due to long lead permitting delays and constructability issues, the Project Team decided that Supply Line 36-9-09 North Section 5 should be sectioned into 5A, 5B⁵, and 5C.⁶ The Project Team identified the following as delays:
 - i. Existing fiber optic lines in close proximity to the train tracks would require additional Union Pacific Railroad oversight when work is performed adjacent to the tracks for the Section 5B project.
 - ii. A geotechnical evaluation for Section 5B revealed a risk of liquefaction in the event of an earthquake for the planned horizontal directional drill (HDD) crossing of Pismo Creek. This resulted in a delay to coordinate design alternatives with a future project.
- b. Once the scope of the Supply Line 36-9-09 North Section 5 Project was split, the Project Team planned the scope of the Supply Line 36-9-09 North Section 5A Project with two replacement sections and two hydrotest sections with one continuous hydrotest. The Project Team designed the Project to reduce the number of test breaks and reduce the impact of construction on the community. This required the inclusion of Incidental mileage because it was located between two sections of Category 4 Criteria pipe within the hydrotest section.

⁵ Supply Line 36-9-09 sections are Supply Lines 36-9-09 North Section 5B and 5C Replacement Projects will be submitted for reasonableness review in a future proceeding.

⁶ Ibid

Pipeline Safety Enhancement Plan Final Report
Supply Line 36-9-09 Section 5A Hydrotest and Replacement Project

- c. The Project Team installed an extended replacement section along Bello Street to reduce future construction impacts during the future Supply Line 36-9-09 Section 5B project.
4. Final Project Scope: The final project scope consists of a 0.572 mile hydrotest and two non-contiguous replacement sections that total 0.914 miles. The Accelerated mileage consists of 0.215 miles of Phase 2B pipe and 142 feet of Incidental pipe.

B. Decision Tree Analysis

SoCalGas and SDG&E performed a PSEP Decision Tree analysis of Supply Line 36-9-09 North Section 5A and confirmed the project design should commence as a Hydrotest and Replacement Project. Supply Line 36-9-09 North Section 5A was evaluated for pressure testing of post-1946 sections and replacement of pre-1946 sections.

For post-1946 vintage pipeline segments longer than 1,000 feet in length, under the approved PSEP Decision Tree, SoCalGas and SDG&E complete a preliminary review to determine whether SoCalGas and SDG&E can manage customer service impacts if the pipeline segment is taken out of service for a period of two to six weeks to complete pressure testing. Where mitigation of customer impacts to remove the line from service for pressure testing is feasible, SoCalGas and SDG&E compare the costs, constructability, risks, and benefits of pressure testing and replacement to determine whether pressure testing or replacement is the more prudent option.

Pipeline Safety Enhancement Plan Final Report
Supply Line 36-9-09 Section 5A Hydrotest and Replacement Project

Pre-1946 vintage, pipeline segments installed prior to 1946 that are not capable of being assessed using in-line inspection technology are identified for replacement under the approved PSEP Decision Tree. As explained in the testimony supporting the approved PSEP, as part of the work previously completed during implementation federal gas transmission pipeline integrity management regulations (49 CFR 192, Subpart O), SoCalGas and SDG&E have already identified, retrofitted and in-line inspected pre-1946 transmission pipelines that were constructed using acceptable welding techniques and are operationally suited to in-line inspection. The remaining pre-1946 segments in the SoCalGas/SDG&E system are not suited for in-line inspection, likely have non-state-of-the-art welds, and would require significant investment for retrofitting to accommodate in-line inspection tools. Accordingly, consistent with the Commission's directive in D.11-06-017 to "address retrofitting pipeline to allow for inline inspection tools," the requirement in California Public Utilities Code section 958 that upon completion of the PSEP, where warranted, pipelines are to be capable of accommodating in-line inspection devices, and the overarching objectives of PSEP to enhance the safety of the pipeline system in a proactive, cost effective manner, the approved PSEP Decision Tree identifies pre-1946 non-piggable pipeline segments for abandonment and/or replacement.

Pipeline Safety Enhancement Plan Final Report
Supply Line 36-9-09 Section 5A Hydrotest and Replacement Project

Through this Decision Tree analysis, SoCalGas and SDG&E identified pressure testing for post-1946 segments and replacement for pre-1946 segments as the more prudent option. Key considerations that support SoCalGas and SDG&E's determination to pressure test and replace this segment include:

1. Existing Pipe Attributes: Section 5A consisted of some sections of pre-1946 pipe and other newer sections of post-1946 pipe. The Project Team recommended replacement of the pre-1946 pipe, that included non-piggable features, whereas hydrotesting the post-1946 Category 4 pipe reduces overall construction, material and land acquisition costs, and customer impacts.
2. Piggability: Pre-1946 pipe was non-piggable.
3. Pipe Vintage: 1932 and 1960.
4. Shut-In Analysis: The Project Team completed a Request for Engineering Review (RER) analysis and concluded a regulator station could not be shut-in at the hydrotest and the replacement section split off at Price Canyon Road during replacement due to the risk of a pressure drop.
5. Longseam Type: Unknown.
6. Longseam Repair History: No identified issues.
7. Condition of Coating: No identified issues.
8. History of Leaks: One known leak repaired on Price Street.

Pipeline Safety Enhancement Plan Final Report
Supply Line 36-9-09 Section 5A Hydrotest and Replacement Project

C. Engineering, Design, and Planning Factors

SoCalGas and SDG&E reviewed pipeline drawings and other information, contacted internal planning groups, communicated with external stakeholders, conducted survey activities, including reviewing public records and potholing of the area to confirm the presence of underground utilities and substructures, and completed a pre-design site walk. Key factors that influenced the engineering and design of the Project are as follows:

1. Shut-In Analysis: The Project Team completed an RER analysis and concluded that a regulator station located at the split of the hydrotest and the replacement section off Price Canyon Road during replacement could not be shut-in due to risk of a pressure drop. A stopple fitting was installed to maintain service to the customers served off the taps with the exception of two customers that were supported using compressed natural gas (CNG) to prevent any service disruption.
2. Customer Impact: Per the RER, the Project Team installed a stopple fitting to maintain service to the customers served off the taps with the exception of two customers that were supported using CNG to prevent any service disruption.
3. Community Impact: The Project Team, working with the city, evaluated community impacts along “Hotel Row” and determined that the businesses would be heavily impacted for ingress and egress accessibility if a single lane closure occurred. Traffic control plans utilized flaggers and signage to maintain two lanes of traffic flow to reduce the impacts. Two customer taps along “Hotel Row” would require CNG support. There was no disruption of service due to the installation of a stopple fitting along Price Canyon Road.

Pipeline Safety Enhancement Plan Final Report Supply Line 36-9-09 Section 5A Hydrotest and Replacement Project

4. Diameter Changes: The Project Team replaced the existing [REDACTED] line with a [REDACTED] line based on the recommendation of the RER.
5. Known Substructures: The Project Team researched existing records and survey results and identified multiple substructures within the construction alignment that included water, sanitary sewer, storm drains, gas, communication, and electrical utilities.
6. Permit Conditions: The City of Pismo Beach imposed moratoriums on construction activity during major events and weekends.
7. Environmental: The risk of archaeological artifacts and sensitive areas prompted preventative mitigation efforts that included an environmental monitor for the overall environmental concerns and cultural monitors to specifically monitor the excavations for archaeological artifacts.
8. Reroute: The Project Team installed an extended replacement section along Bello Street to reduce future construction impacts during the Supply Line 36-9-09 Section 5B project.

Pipeline Safety Enhancement Plan Final Report
Supply Line 36-9-09 Section 5A Hydrotest and Replacement Project

D. Scope Changes

Through engineering, design, and planning activities, SoCalGas and SDG&E determined that changes in scope were appropriate to enhance the design of the Project and address engineering factors. As a result, the preliminary cost estimate does not fully reflect the final scope. The notable change in scope made after the preliminary cost estimate was developed and approved was that the Project Team initially estimated the Supply Line 36-9-09 Section 5A Project as one continuous project that was later rescope to three project sections: 5A, 5B, and 5C. This split was due to the challenges with the pipeline replacement crossing Pismo Creek.

Pipeline Safety Enhancement Plan Final Report
Supply Line 36-9-09 Section 5A Hydrotest and Replacement Project

III. CONSTRUCTION

A. Construction Contractor Selection

The Project Team prepared an initial cost estimate based on the preliminary design. Following completion of the engineering, design, and planning activities described above, the Project Team directed the Performance Partner to prepare cost estimates based on a more detailed engineering design package, that included the updated design described in the discussion of notable Scope Changes above. SoCalGas and SDG&E awarded the construction contract to the Performance Partner.

1. SoCalGas and SDG&E’s Preliminary Construction Cost Estimate (*confidential*):
SoCalGas and SDG&E’s preliminary cost estimate for construction on Section 5A was [REDACTED].
2. Construction Contractor’s Target Price Estimate (*confidential*): The Construction Contractor’s cost estimate was [REDACTED], that was [REDACTED] than SoCalGas and SDG&E’s preliminary cost estimate for construction.

B. Construction Schedule

Table 3: Construction Timeline

Construction Start Date	02/08/2016
Construction Completion Date	07/22/2016
NOP Date	06/23/2016

Pipeline Safety Enhancement Plan Final Report
Supply Line 36-9-09 Section 5A Hydrotest and Replacement Project

C. Changes During Construction

The conditions summarized below were encountered during construction. Activities to address or mitigate these conditions resulted in approximately \$2,270,000 in change orders.

1. Field Design Change: The Operating District's most recent leak survey at the time identified a potential leak leading to concerns about a hydrotest failure. The Construction Contractor completed an additional excavation to conduct a non-destructive examination (NDE). This location failed the NDE and resulted in the decision to replace the planned hydrotest section on Price Street with a 1,050 foot replacement using HDD. With the revised scope, the Construction Contractor would need to verify the distance between the new proposed [REDACTED] pipeline and existing [REDACTED] pipeline. The Construction Contractor dug additional slot trenches to accurately identify adjacent substructures and utilities.
2. Schedule Delay: This project encountered several non-contiguous construction delays that were due to changes in permitting requirements, changes in design, and mitigating environmental concerns.
3. Site Restoration:
 - a. The preexisting asphalt at the Bello Street laydown yard had no compacted sub-base. The use of heavy equipment and heavy rain caused the asphalt fractures (cracks) to enlarge. To restore the site to a pre-construction condition, the Construction Contractor repaved the damaged surface and provided trench plates during construction to prevent further damage.

Pipeline Safety Enhancement Plan Final Report
Supply Line 36-9-09 Section 5A Hydrotest and Replacement Project

- b. Due to the replacement alignment crossing the centerline multiple times, the Project Team needed to pave the entire width of the roadway curb to curb. The expansion of the paving scope required additional grinding and capping, along with reflective striping.
4. Tie-In:
 - a. The City of Pismo Beach restricted traffic control hours to only eight hour days during the tie-in as opposed to a continuous 24 hour shift. This caused SoCalGas and SDG&E to redesign the gas handling plan and delay the tie-in from June 7, 2016 to June 24, 2016. This change placed the construction crew on stand by until the tie-in could be completed.
 - b. During bell hole inspection at the tie-in location on Bello Street, a seam containing a defect was identified on the existing [REDACTED] pipe once the pipe was excavated. The Project Team relocated this tie-in location to an alternative location and the pipe with the seam defect was included in the abandonment section.
5. Work Hours: To prevent interference with the anticipated increase of traffic from the Memorial Day Holiday, Caltrans and the City of Pismo Beach requested work hours be increased from eight hour days to 12 hour days prior to the imposed moratorium on construction activity.
6. Traffic: In response to a complaint from a hotel on Price Street regarding unsafe vehicle ingress and egress, the Construction Contractor provided additional flagmen to direct traffic.

Pipeline Safety Enhancement Plan Final Report
Supply Line 36-9-09 Section 5A Hydrotest and Replacement Project

7. Environmental: While excavating the tie-in bell hole at Mattie Road and Price Street, the Project Team identified Native American artifacts and midden soil⁷. To preserve this sensitive location, the Construction Contractor went on stand-by, and a new tie-in location had to be identified. In efforts to prevent further encroachment on the midden soil, the Construction Contractor provided potholing support to the archeologists and Native American monitors.

⁷ An archeological term that refers to a trash heap site.

Pipeline Safety Enhancement Plan Final Report Supply Line 36-9-09 Section 5A Hydrotest and Replacement Project

Figure 4: Setting up to Weld on Bello Street



Pipeline Safety Enhancement Plan Final Report Supply Line 36-9-09 Section 5A Hydrotest and Replacement Project

D. Commissioning and Site Restoration

Commissioning activities include restoration of the site, final inspection and placement of the pipeline back into service, transportation and disposal of hydrotested water and hazardous material, and site demobilization. Closeout activities include development of final drawings, finalization of a reconciliation package, and updates to company recordkeeping systems to reflect the completed scope of work.

Pipeline Safety Enhancement Plan Final Report
Supply Line 36-9-09 Section 5A Hydrotest and Replacement Project

IV. PROJECT COSTS

A. Cost Avoidance Actions

SoCalGas and SDG&E exercised due diligence in the planning, design, and construction activities for this project to minimize or avoid costs when prudent to do so. As discussed above, the Project Team conducted a pre-design site visit to identify and incorporate discernible site conditions into the engineering, design, and planning of the Project. Specific examples of cost avoidance actions taken on this project are:

1. Engineering and Design: Section 5A was designed to be completed in one continuous hydrotest rather than multiple tests to avoid additional land acquisition and test head material costs.
2. Materials: Bulk ordered pipe provided volume pricing for the [REDACTED] pipe.

B. Cost Estimate

Based on the preliminary design, once the project scope was confirmed and engineering, design, and planning activities were underway, SoCalGas and SDG&E prepared an estimate of the Direct Costs of the Project in the amount of \$8,352,810. This estimate was prepared in April of 2016, using the “SCG Pipeline Estimate Template Rev 3” estimating tool, the most current version of the PSEP Estimate Template at the time. The Project Team considered the conditions known at the time to prepare the preliminary Direct Cost estimate. This estimate reflects the projected Labor, Material, and Services costs anticipated to be incurred to execute the Project.

SoCalGas and SDG&E estimated Indirect Costs of the Project based on the estimated Direct Costs and other project-related variables.

Pipeline Safety Enhancement Plan Final Report
Supply Line 36-9-09 Section 5A Hydrotest and Replacement Project

C. Actual Direct and Indirect Costs

Actual Direct Costs reflect the Labor, Material, and Service costs incurred to execute the Project. Actual Indirect Costs reflect costs for incremental overhead loaders in accordance with Company overhead allocation policies. The total loaded cost of the Project is \$14,199,256.

Table 4: Estimated and Actual Direct Costs and Variances

Direct Costs (\$)	Estimate	Actuals	Delta Over/(Under)
Company Labor	443,422	197,165	(246,257)
Materials	457,153	517,437	60,284
Construction Contractor	3,882,008	6,328,090	2,446,082
Construction Management & Support	393,705	1,045,339	651,634
Environmental	797,135	746,843	(50,292)
Engineering & Design	1,037,600	2,110,471	1,072,871
Project Management & Services	289,827	201,880	(87,947)
ROW & Permits	150,827	271,044	120,217
GMA	901,133	1,137,034	235,901
Total Direct Costs	8,352,810	12,555,303	4,202,493

Table 5: Estimated and Actual Indirect Costs, Total Costs, and Variances

Indirect Costs/Total Costs (\$)	Estimate	Actuals	Delta Over/(Under)
Overheads	862,033	919,684	57,651
AFUDC	979,968	637,741	(342,227)
Property Taxes	217,342	86,528	(130,814)
Total Indirect Costs	2,059,343	1,643,953	(415,390)
Total Direct Costs	8,352,810	12,555,303	4,202,493
Total Loaded Costs	10,412,153	14,199,256	3,787,103

Pipeline Safety Enhancement Plan Final Report
Supply Line 36-9-09 Section 5A Hydrotest and Replacement Project

D. Disallowances

There was no disallowance for Supply Line 36-9-09 Section 5A as there were no post-1955 segments included in the Project without records that provide the minimum information to demonstrate compliance with then applicable industry standards or regulatory strength testing and recordkeeping requirements.

Pipeline Safety Enhancement Plan Final Report
Supply Line 36-9-09 Section 5A Hydrotest and Replacement Project**V. CONCLUSION**

SoCalGas and SDG&E enhanced the safety of their integrated natural gas transmission system by prudently executing the Line 36-9-09 North Section 5A Hydrotest and Replacement Project. Through this Hydrotest and Replacement Project, SoCalGas and SDG&E successfully hydrotested and replaced 1.493 miles of pipe in the City of Pismo Beach. The total loaded cost of the Project is \$14,199,256.

SoCalGas and SDG&E executed this project prudently through engagement in scope validation efforts that reduced project mileage and responding to numerous unanticipated field conditions including an additional HDD crossing, excavation of archeological artifacts, and additional traffic control for the safety of the general public and construction crews.

SoCalGas and SDG&E engaged in prudent cost avoidance efforts by sharing construction resources and avoiding stand by charges from the construction contractor by diverting construction resources to other adjacent projects.

**End of Supply Line 36-9-09 North Section 5A Hydrotest and
Replacement Project Final Report**

Pipeline Safety Enhancement Plan Final Report
Supply Line 49-13 Replacement and Hydrotest Project

I. SUPPLY LINE 49-13 REPLACEMENT AND HYDROTEST PROJECT

A. Background and Summary

Supply Line 49-13 is a predominantly [REDACTED] diameter transmission line located in a highly developed and heavily populated area that runs approximately 4 miles from the City of Santee to El Cajon. The pipeline is primarily routed across a Class 3 location. This report describes the activities associated with the Supply Line 49-13 Replacement and Hydrotest Project that consists of the Replacement of 1.200 miles of pipeline and the Hydrotest of 1.975 miles of pipeline. The specific attributes of this Project are detailed in Table 1 below. A portion of the replacement consisted of an 836-foot horizontal directional drill (HDD) engineered crossing. The Project was divided into three sections for project management purposes and to mitigate service impacts to customers. The specific attributes of this Project are detailed in Table 1 below. The total loaded cost of the Project is \$23,579,057.

Pipeline Safety Enhancement Plan Final Report
Supply Line 49-13 Replacement and Hydrotest Project

Table 1: General Project Information

Project Name		Supply Line 49-13 Section 1 and Section 2		
Project Type	Replacement			
Length	1.200 miles			
Location	Santee			
Class	3			
MAOP (<i>confidential</i>)	[REDACTED]			
Pipe Vintage	1959			
Construction Start	09/08/2015			
Construction Finish	07/28/2017			
Original Pipe Diameter (<i>confidential</i>)	[REDACTED]			
New Diameter (<i>confidential</i>)	[REDACTED]			
Original SMYS ¹ (<i>confidential</i>)	[REDACTED]			
New SMYS (<i>confidential</i>)	[REDACTED]			
Project Name		Supply Line 49-13 Section 3		
Project Type	Hydrotest			
Length	1.975 miles			
Location	El Cajon			
Class	3			
MAOP (<i>confidential</i>)	[REDACTED]			
Pipe Vintage	1959			
Construction Start	07/28/2015			
Construction Finish	11/23/2015			
Original Pipe Diameter (<i>confidential</i>)	[REDACTED]			
New Diameter (<i>confidential</i>)	N/A			
Original SMYS ¹ (<i>confidential</i>)	[REDACTED]			
New SMYS (<i>confidential</i>)	N/A			
Project Costs (\$)		Capital	O&M	Total
Loaded Project Costs		19,009,868	4,569,189	23,579,057
Disallowed Costs		-	-	-

¹ Highest percentage of Specified Minimum Yield Strength (SMYS) of Category 4 Criteria pipe.

Pipeline Safety Enhancement Plan Final Report
Supply Line 49-13 Replacement and Hydrotest Project

B. Maps and Images

Figure 1: Satellite Image of Supply Line 49-13 Replacement and Hydrotest Project



Pipeline Safety Enhancement Plan Final Report
 Supply Line 49-13 Replacement and Hydrotest Project

Figure 2: Overview Map of Supply Line 49-13 Replacement and Hydrotest Project

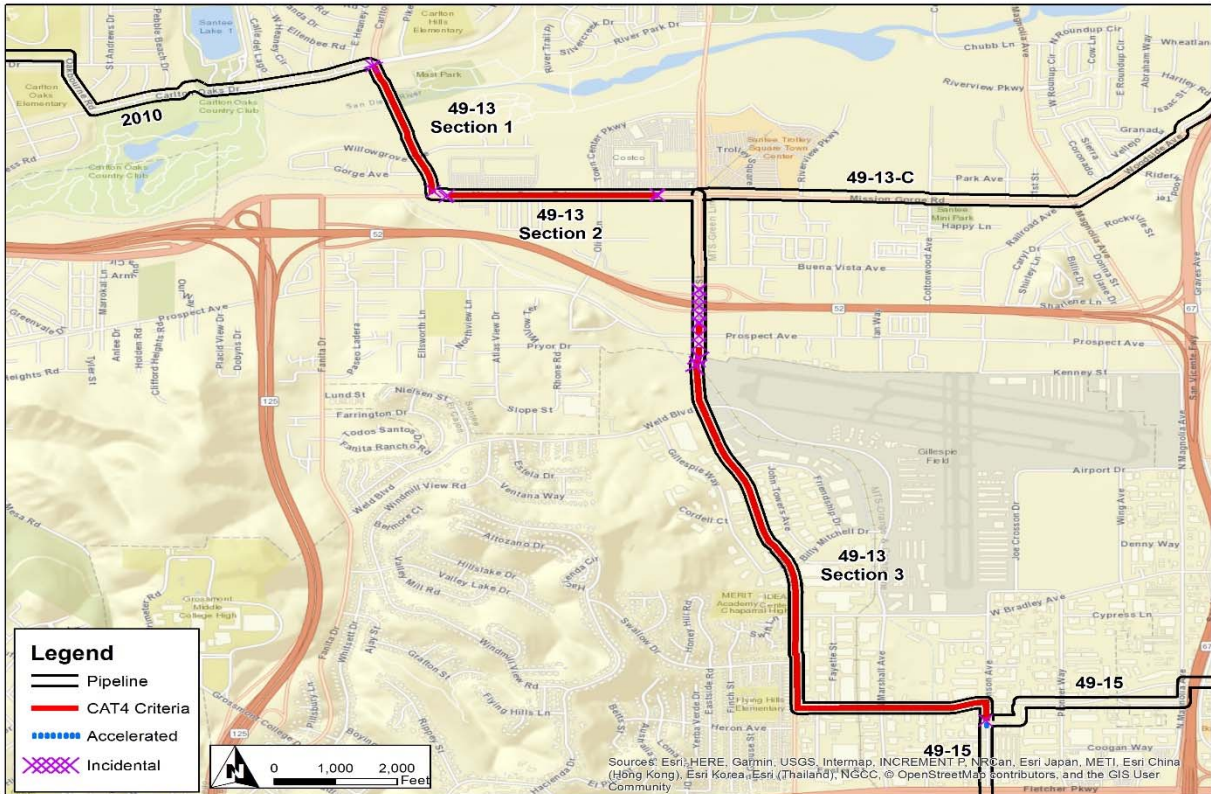

Pipeline Safety Enhancement Plan Final Report
Supply Line 49-13 Replacement and Hydrotest Project

Figure 3: Satellite Image of Supply Line 49-13 Section 1 and Section 2 Replacement Project

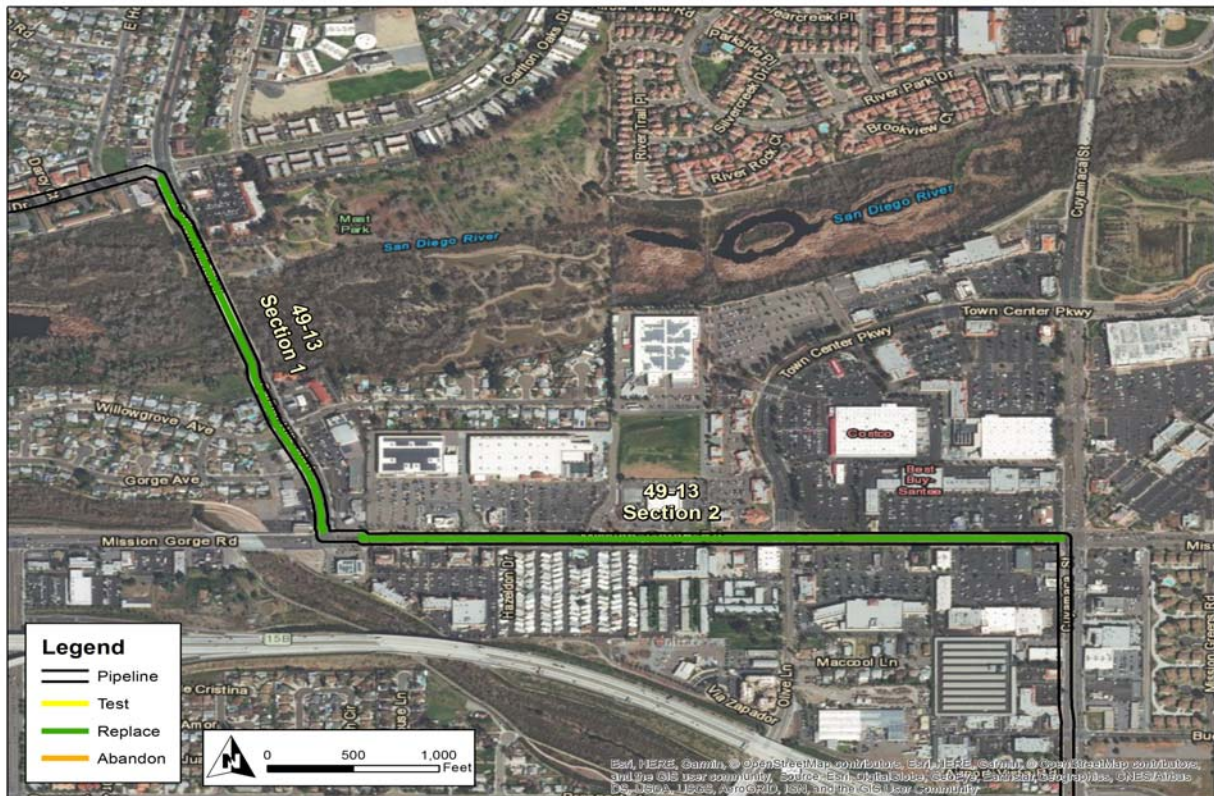

Pipeline Safety Enhancement Plan Final Report
Supply Line 49-13 Replacement and Hydrotest Project

Figure 4: Overview Map of Supply Line 49-13 Section 1 and Section 2 Replacement Project



Pipeline Safety Enhancement Plan Final Report
 Supply Line 49-13 Replacement and Hydrotest Project

Figure 5: Satellite Image of Supply Line 49-13 Section 3 Hydrotest Project



Pipeline Safety Enhancement Plan Final Report Supply Line 49-13 Replacement and Hydrotest Project

Figure 6: Overview Map of Supply Line 49-13 Section 3 Hydrotest Project

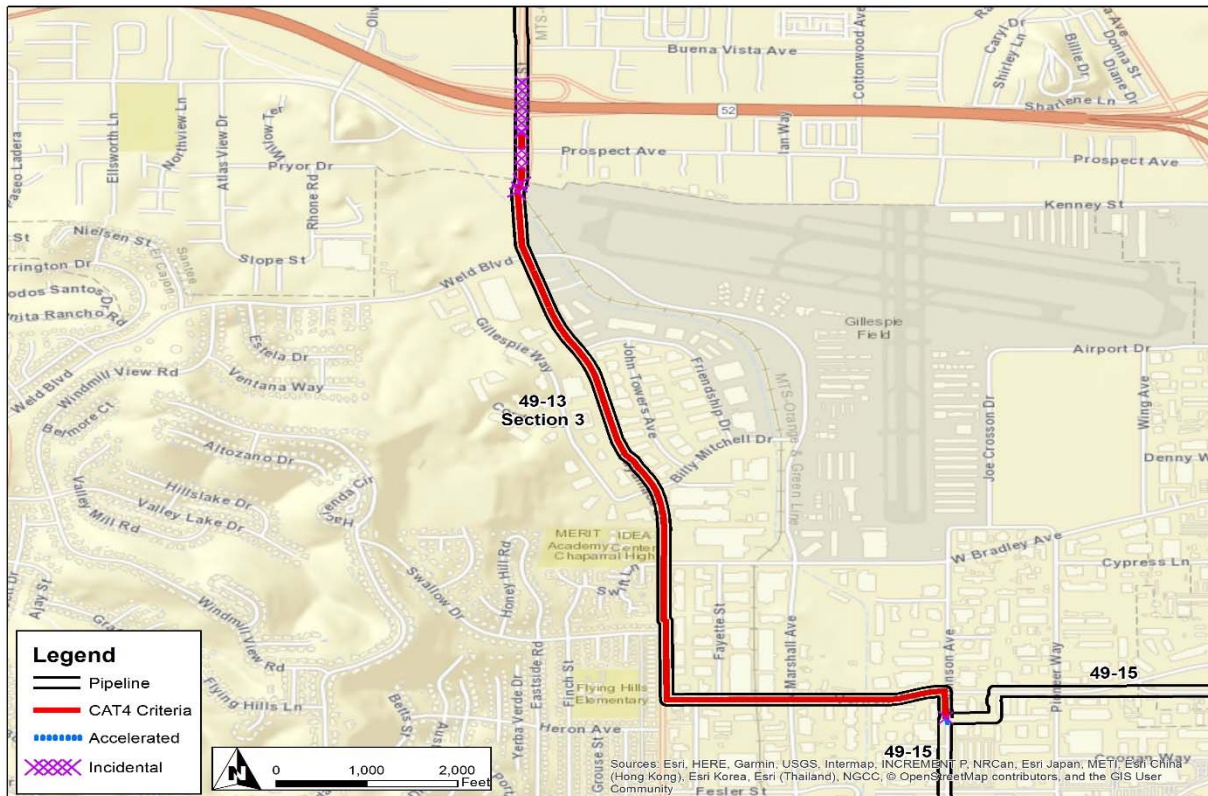

Pipeline Safety Enhancement Plan Final Report
Supply Line 49-13 Replacement and Hydrotest Project

II. ENGINEERING, DESIGN, AND PLANNING

A. Project Scope

Table 2: Mileage Information

	Criteria	Accelerated ²	Incidental	New	Total ³
Sec 1 & 2 Replacement	1.146 mi.	0 mi.	0.021 mi.	0.032 mi.	1.200 mi.
	6,052 ft.	0 ft.	112 ft.	171 ft.	6,335 ft.
Section 3 Hydrotest	1.792 mi.	0.003 mi.	0.177 mi.	0.002 mi.	1.975 mi.
	9,462 ft.	17 ft.	937 ft.	11 ft.	10,426 ft.
Total Final Mileage	2.938 mi.	0.003 mi.	0.199 mi.	0.034 mi.	3.175 mi.
	15,514 ft.	17 ft.	1049 ft.	181 ft.	16,761 ft.

SoCalGas and SDG&E presented a conceptual project scope in workpapers supporting the 2011 PSEP filing.⁴ Prior to initiating execution of the Project in 2015, SoCalGas and SDG&E reviewed existing pipeline records to validate the scope of the Project. During the Engineering, Design, and Planning phase, SoCalGas and SDG&E further refined the scope. The progression of project scope is summarized as follows:

1. 2011 PSEP Filing: SoCalGas and SDG&E identified Supply Line 49-13 as a Phase 1A Replacement Project comprised of 3.464 miles of Category 4 Criteria pipe.

² Accelerated mileage includes Phase 2B pipe. Phase 2B includes pipelines with record of a pressure test, but without record of a pressure test to modern – Subpart J – standards (Phase 2B). The Accelerated mileage was included to realize efficiencies and to enhance project constructability.

³ Values may not add to total due to rounding.

⁴ See Amended PSEP of SoCalGas and SDG&E, submitted December 2, 2011, in R.11-02-019 and subsequently transferred to A.11-11-002.

Pipeline Safety Enhancement Plan Final Report
Supply Line 49-13 Replacement and Hydrotest Project

2. Scope Validation: Through scope validation activities, after the 2011 filing and before initiating execution of the Project, SoCalGas and SDG&E successfully reduced the scope of the Project by 0.506 miles of Category 4 Criteria pipe. Validation efforts identified several segments of pipe operating under 20% SMYS removing them from the PSEP scope.
3. Engineering, Design, and Constructability:
 - a. Based on the Decision Tree, the Project Team determined that this project should be executed as two replacement sections, and one hydrotest section.
 - b. SoCalGas and SDG&E identified Supply Line 49-13-C, a [REDACTED] lateral on Supply Line 49-13 as the sole feed to the Santee area. As a result, a new bridled connection with 152 feet of new pipe and two new bridle valves is required to maintain service.
 - c. A portion of the replacement consisted of an approximately 836 foot HDD under the San Diego River.
 - d. The scope also includes the replacement of five [REDACTED] mainline valves (MLVs), and the removal of one [REDACTED] valve. The installation of new pipe included two new bridle valves.
 - e. Incidental mileage was included to configure the hydrotests and facilitate tie-ins to the existing pipe.
4. Final Project Scope: The final project scope consists of a 1.200 mile Replacement and 1.975 mile Hydrotest. The Accelerated mileage includes 17 feet of Phase 2B pipe, 1,049 feet of Incidental pipe.

Pipeline Safety Enhancement Plan Final Report
Supply Line 49-13 Replacement and Hydrotest Project

B. Decision Tree Analysis

SoCalGas and SDG&E performed a PSEP Decision Tree analysis of Supply Line 49-13 and confirmed the project design should commence as a Hydrotest and Replacement Project.

For pipeline segments longer than 1,000 feet in length, under the approved PSEP Decision Tree, SoCalGas and SDG&E complete a preliminary review to determine whether SoCalGas and SDG&E can manage customer service impacts if the pipeline segment is taken out of service for a period of two to six weeks to complete pressure testing. Where mitigation of customer impacts to remove the line from service for pressure testing is feasible, SoCalGas and SDG&E compare the costs, constructability, risks, and benefits of pressure testing versus a replacement to determine whether pressure testing or replacement is the more prudent option.

Through this Decision Tree analysis, SoCalGas and SDG&E identified replacement for Section 1 and Section 2 and pressure testing for Section 3 as the most prudent option. Key considerations that support SoCalGas and SDG&E's determination to pressure test one section and replace two sections include:

Section 1 and Section 2 Replacement

1. Shut-In Analysis: The Project Team completed a Request for Engineering Review (RER) analysis and concluded that Section 1 and Section 2 could not be shut-in at the same time. The RER determined that the Project Team must isolate any line shut-ins in a manner that will not interrupt service.
2. Customer Impacts: The RER identified a [REDACTED] lateral pipe as the sole feed to the Santee area and can therefore not be shut-in without alternate means of providing service.

Pipeline Safety Enhancement Plan Final Report
Supply Line 49-13 Replacement and Hydrotest Project

3. Piggability: Non-piggable.
4. Pipe Vintage: 1959.
5. Existing Pipe Attributes:
 - a. The Project Team identified miter bends, plug valves, and non-piggable pressure control fittings (PCFs) that would need to be replaced in order to perform a hydrotest.
 - b. The Project Team identified the existing pipeline had reduced wall thickness due to remediated pipe damage during construction of the San Diego River bridge.
6. History of Leaks: One leak repair recorded in 1966 (approximately 475 feet north of Willowgrove Avenue) is located within Section 1.
7. Other Identified Risks: The Project Team determined that a hydrotest failure could affect many businesses and residences and create environmental issues for sensitive waterways in close proximity to the Project.
8. Cost Analysis: Since Section 1 and Section 2 could not be shut-in at the same time, the Project Team completed a cost analysis for hydrotest and replacement of each section separately. The project team determined replacement as the more prudent option based on the condition of the pipe within these sections and the incremental cost difference between replacement and hydrotesting with improvements to remove non-piggable features.

Section 3 Hydrotest

1. Shut-In Analysis: The Project Team completed an RER analysis and concluded that this section of the line could be taken out of service.

Pipeline Safety Enhancement Plan Final Report
Supply Line 49-13 Replacement and Hydrotest Project



2. Customer Impacts: Section 3 feeds a municipal transit system compressed natural gas (CNG) filling station. The Project Team did not anticipate any impacts to customer service.
3. Piggability: Non-piggable.
4. Existing Pipe Attributes: The Project Team identified many preexisting features such as miter bends and non-piggable PCFs. The Project Team determined these features should be replaced to perform a hydrotest.
5. Pipe Vintage: 1959.
6. Longseam Type: Unknown.
7. Longseam Repair History: No identified issues.
8. Other Identified Risks: The Project Team determined that a hydrotest failure could affect many businesses and residences, as well as create environmental issues for sensitive waterways in close proximity to the Project.

C. Engineering, Design, and Planning Factors

SoCalGas and SDG&E reviewed pipeline drawings and other information, contacted internal planning groups, communicated with external stakeholders, conducted survey activities, including reviewing public records, and potholing of the area to confirm the presence of underground utilities and substructures, and completed a pre-design site walk. Key factors that influenced the engineering and design of the Project sections are as follows:

Pipeline Safety Enhancement Plan Final Report
Supply Line 49-13 Replacement and Hydrotest Project

Sections 1 and 2 Replacement

1. Shut-In Analysis: As discussed above, the Project Team completed an RER analysis and concluded that Section 1 and Section 2 could not be shut in at the same time. The Project Team designed a new bridled connection with two new   bridle valves to maintain service to a lateral connection and isolate Section 2 without having an impact to customers. The Project Team divided the Project into sections to accommodate the recommended isolation points stated in the RER.
2. Customer Impacts: The Project Team planned for a new bridled connection to Supply Line 49-13-C to mitigate any customer impacts.
3. Community Impacts: Supply Line 49-13 is aligned within three major streets in the City of Santee and El Cajon. These streets serve several businesses, homes, and schools. Construction activity would impact traffic on these roads.
4. Schedule Coordination:
 - a. The Project Team scheduled construction activities and installed the new pipe in sections as permits were received.
 - b. The Project Team also scheduled construction activities before the city moratorium took place. The City of Santee moratorium restricts any construction activities between Thanksgiving Day and New Year's Day.
5. Land Use: The Project Team secured a laydown yard for all three Project sections and was shared with other PSEP projects in the area.
6. Environmental: The San Diego River is a protected waterway that prevented the possibility of open trench installation of pipe, therefore the Project Team decided to execute the project using HDD under the San Diego River.

Pipeline Safety Enhancement Plan Final Report
Supply Line 49-13 Replacement and Hydrotest Project

7. Permit Conditions:

- a. The City of Santee had a prolonged permit review period due to the complexity of the HDD process, and due to the atypical scale of scope that the available city staff typically reviews.
- b. The permit restricted work to nighttime and the paving required temperatures only achievable during nighttime summer conditions. This resulted in a delay of final restoration.
- c. The Project Team decided to execute Section 1 of the Project last in anticipation of an extended review period for the Department of Fish and Wildlife permit for the HDD crossing.

8. Work Hours: The Project Team planned for 8 hour days during weekdays, and coordinated construction activities around the City of Santee moratorium between Thanksgiving Day and New Year's Day.

9. Valves: The Project Team replaced three MLVs in Sections 1 and 2, and installed two new [REDACTED] bridle valves on lateral Supply Line 49-13-C.

Section 3 Hydrotest

1. Shut-In Analysis: As stated above, the Project Team completed an RER analysis and concluded that this section of pipe could be shut in, therefore the Project Team planned for one hydrotest.
2. Customer Impacts: Supply Line 49-13 is the sole feed for many core customers in the El Cajon area and a municipal transit system CNG filling station. PSEP mitigated customer impacts by sectionalizing the Project and coordinating a shutdown with the CNG filling facility.

Pipeline Safety Enhancement Plan Final Report
Supply Line 49-13 Replacement and Hydrotest Project

3. Community Impacts: Supply Line 49-13 is aligned within major streets of El Cajon. These streets serve several businesses, homes, and a municipal airport. Construction activity would have an impact on traffic.
4. Substructures: The Project Team conducted potholing to verify pipe and feature locations.
5. Land Use: The Project Team secured a laydown yard for all three sections of the Project and was shared with other PSEP projects in the area.
6. Work Hours: The Project Team planned for eight hour days during weekdays and coordinated construction activities around the City of El Cajon moratorium between Thanksgiving Day and New Year's Day.
7. Valves: The Project Team determined the project scope to include the replacement of two non-piggable mainline valves (MLVs) and the abandonment of one preexisting valve.

D. Scope Changes

SoCalGas and SDG&E did not make any notable scope changes during detailed design.

Pipeline Safety Enhancement Plan Final Report
Supply Line 49-13 Replacement and Hydrotest Project

III. CONSTRUCTION

A. Construction Contractor Selection

The Project Team prepared an initial cost estimate based on the preliminary design. Following completion of the engineering, design, and planning activities described above, the Project Team directed the Performance Partner to prepare cost estimates based on a more detailed engineering design package. As indicated above, there were no notable changes in scope between the time when the Project Team prepared the preliminary cost estimate and when the Performance Partner prepared and submitted its Target Price Estimate. SoCalGas and SDG&E awarded the construction contract to the Performance Partner.

1. SoCalGas and SDG&E's Preliminary Construction Cost Estimate (*confidential*):

SoCalGas and SDG&E's preliminary cost estimate for construction was [REDACTED]

2. Construction Contractor's Target Price Estimate (*confidential*): The Construction Contractor's cost estimate was [REDACTED], which was [REDACTED] than SoCalGas and SDG&E's preliminary cost estimate for construction.

Pipeline Safety Enhancement Plan Final Report
Supply Line 49-13 Replacement and Hydrotest Project

B. Construction Schedule

Table 3: Construction Timeline

Section 1	
Construction Start Date	05/01/2016
Construction Completion Date	07/28/2017
NOP Date	07/21/2016
Section 2	
Construction Start Date	09/08/2015
Construction Completion Date	09/22/2016
NOP Date	11/23/2015
Section 3	
Construction Start Date	07/28/2015
Construction Completion Date	11/23/2015
NOP Date	11/23/2015

C. Changes During Construction

The conditions summarized below were encountered during construction. Activities to address or mitigate these conditions resulted in approximately \$81,800 in credit to SoCalGas and SDG&E.

1. Constructability: The Construction Contractor encountered soil conditions that were better than anticipated. These conditions improved the overall production and had a desirable effect to cost and schedule. The Construction Contractor ultimately issued a cost credit to SoCalGas and SDG&E as a result.
2. Other: The Construction Contractor potholed numerous times to verify the locations of the existing pipeline and fittings. Following these efforts, the Project Team changed their approach and performed a closed circuit television (CCTV) inspection.

Pipeline Safety Enhancement Plan Final Report
Supply Line 49-13 Replacement and Hydrotest Project

The inspection revealed additional pipe attributes that needed replacement prior to performing a hydrotest. Although the replacement of these previously unknown attributes contributed to additional cost, the Project Team estimates the cost to be less than the potential cost of having to mitigate a hydrotest failure if these attributes were not replaced.

D. Commissioning and Site Restoration

Commissioning activities include restoration of the site, final inspection and placement of the pipeline back into service, transportation and disposal of the hydrotested water and hazardous material, and site demobilization. Closeout activities include development of final drawings, finalization of a reconciliation package, and updates to company recordkeeping systems to reflect the completed scope of work.

Pipeline Safety Enhancement Plan Final Report
Supply Line 49-13 Replacement and Hydrotest Project

IV. PROJECT COSTS

A. Cost Avoidance Actions

SoCalGas and SDG&E exercised due diligence in the planning, design, and construction activities for this project to minimize or avoid costs when prudent to do so. As discussed above, the Project Team conducted a site visit to identify and incorporate discernible site conditions into the engineering, design, and planning of the Project. Specific examples of cost avoidance actions taken on this project are:

1. Planning and Coordination: The gas handling schedule for Section 2 and Section 3 were coordinated as one event, thus eliminating a second gas handling activity that reduced company labor support.
2. Materials: Bulk ordered pipe provided volume pricing for the [REDACTED] pipe.
3. Scope Change: The Project Team reduced the length of tested miles during the early stages of development of the Project.
4. Land Use: The Project Team coordinated with other projects to share land resources. The Project Team also acquired a yard that was used for laydown and a test head location.
5. Future Maintenance: By coordinating with the local transit authority to eliminate a approximately 250 foot bypass to their CNG facility, the Project Team prevented future maintenance and servicing costs.
6. Permit Conditions: An external corrosion data assessment (ECDA) reassessment took place during construction to take advantage of permits that allowed access to the pipeline. The reassessment provided relevant information.

Pipeline Safety Enhancement Plan Final Report
Supply Line 49-13 Replacement and Hydrotest Project

7. Water Management: The Project Team saved costs on water by using reclaimed sources and storing the water at the same location for all three hydrotests.

B. Cost Estimate

Based on the preliminary design, once the project scope was confirmed and engineering, design, and planning activities were underway, SoCalGas and SDG&E prepared an estimate of the Direct Costs of the Project in the amount of \$12,682,578. This estimate was prepared in September of 2014, using the “SCG Pipeline Estimate Template Rev 1” estimating tool, the most current version of the PSEP Estimate Template at the time. The Project Team considered the conditions known at the time to prepare the preliminary Direct Cost estimate. This estimate reflects the projected Labor, Material, and Services costs anticipated to be incurred to execute the Project.

SoCalGas and SDG&E estimated Indirect Costs of the Project based on the estimated Direct Costs and other project-related variables.

C. Actual Direct and Indirect Costs

Actual Direct Costs reflect the Labor, Material, and Service costs incurred to execute the Project. Actual Indirect Costs reflect costs for incremental overhead loaders in accordance with Company overhead allocation policies. The total loaded cost of the Project is \$23,579,057.

Pipeline Safety Enhancement Plan Final Report
Supply Line 49-13 Replacement and Hydrotest Project

Table 4: Estimated and Actual Direct Costs and Variances

Direct Costs (\$)	Estimate	Actuals	Delta Over/(Under)
Company Labor	1,043,319	668,568	(374,751)
Materials	1,248,407	616,049	(632,358)
Construction Contractor	6,250,616	10,647,690	4,397,074
Construction Management & Support	608,207	2,221,621	1,613,414
Environmental	705,925	328,939	(376,986)
Engineering & Design	1,158,185	3,701,753	2,543,568
Project Management & Services	355,160	550,510	195,350
ROW & Permits	255,877	516,306	260,429
GMA	1,056,882	1,600,404	543,522
Total Direct Costs	12,682,578	20,851,840	8,169,262

Table 5: Estimated and Actual Indirect Costs, Total Costs and Variances

Indirect Costs/Total Costs (\$)	Estimate	Actuals	Delta Over/(Under)
Overheads	1,844,510	2,438,565	594,055
AFUDC	1,387,452	251,390	(1,136,062)
Property Taxes	-	37,262	37,262
Total Indirect Costs	3,231,962	2,727,217	(504,745)
Total Direct Costs	12,682,578	20,851,840	8,169,262
Total Loaded Costs	15,914,540	23,579,057	7,664,517

Pipeline Safety Enhancement Plan Final Report
Supply Line 49-13 Replacement and Hydrotest Project

D. Disallowance

There was no disallowance for Supply Line 49-13 as there were no post-1955 segments included in the Project without records that provide the minimum information to demonstrate compliance with then applicable industry standards or regulatory strength testing and recordkeeping requirements.

Pipeline Safety Enhancement Plan Final Report
Supply Line 49-13 Replacement and Hydrotest Project

V. CONCLUSION

SoCalGas and SDG&E enhanced the safety of their integrated natural gas transmission system by prudently executing the Supply Line 49-13 Replacement and Hydrotest Project. Through this Replacement and Hydrotest Project, SoCalGas and SDG&E successfully replaced and hydrotested 3.175 miles of pipe in the Cities of Santee and El Cajon. The total loaded cost of the Project is \$23,579,057.

SoCalGas and SDG&E executed this project prudently through effective scope validation and reducing mileage from scope.

SoCalGas and SDG&E engaged in prudent cost avoidance efforts by using reclaimed water for testing, sharing a laydown yard, and reducing the amount of gas handling events that would require additional unplanned failure.

End of Supply Line 49-13 Final Report

Pipeline Enhancement Plan Final Report
Line 404 Hydrotest and Replacement Projects

I. LINE 404 HYDROTEST AND REPLACEMENT PROJECTS

A. Background and Summary

Line 404 is a predominantly [REDACTED] diameter transmission line that runs approximately 55 miles through the City of Ventura, Somis, Camarillo, Moorpark, Thousand Oaks, Oak Park, Woodland Hills, and terminating in Encino. The pipeline is primarily routed across a Class 3 location. This report describes the activities associated with the Line 404 Hydrotest and Replacement Projects that consists of the hydrotest of approximately 12 miles of pipeline and replacement of approximately 0.3 miles of pipeline that was managed and executed in eight sections. The specific attributes of this Project are detailed in Table 1 below. The total loaded cost of the Project is \$26,331,900.

Pipeline Enhancement Plan Final Report
Line 404 Hydrotest and Replacement Projects

Table 1: General Project Information

Project Name	Section 1
Project Type	Replacement
Length	0.028 miles
Location	Ventura
Class	3
MAOP (<i>confidential</i>)	[REDACTED]
Pipe Vintage	1944
Construction Start	09/22/2015
Construction Finish	11/24/2015
Original Pipe Diameter (<i>confidential</i>)	[REDACTED]
New Diameter (<i>confidential</i>)	[REDACTED]
Original SMYS ¹ (<i>confidential</i>)	[REDACTED]
New SMYS (<i>confidential</i>)	[REDACTED]
Project Name	Section 2
Project Type	Hydrotest
Length	2.976 miles
Location	Ventura
Class	3
MAOP (<i>confidential</i>)	[REDACTED]
Pipe Vintage	1944
Construction Start	09/22/2015
Construction Finish	12/22/2015
Original Pipe Diameter (<i>confidential</i>)	[REDACTED]
New Diameter (<i>confidential</i>)	N/A
Original SMYS ² (<i>confidential</i>)	[REDACTED]
New SMYS (<i>confidential</i>)	N/A

¹ Highest percentage of Specified Minimum Yield Strength (SMYS) of Category 4 Criteria pipe.

² Ibid

Pipeline Enhancement Plan Final Report
Line 404 Hydrotest and Replacement Projects

Table 1: General Project Information (Continued)

Project Name	Section 2A
Project Type	Hydrotest
Length	0.817 miles
Location	Ventura
Class	3
MAOP (<i>confidential</i>)	████████
Pipe Vintage	1944
Construction Start	03/20/2017
Construction Finish	07/13/2017
Original Pipe Diameter (<i>confidential</i>)	████████
New Diameter (<i>confidential</i>)	N/A
Original SMYS ³ (<i>confidential</i>)	████████
New SMYS (<i>confidential</i>)	N/A
Project Name	Section 3
Project Type	Hydrotest
Length	0.538 miles
Location	Ventura
Class	3
MAOP (<i>confidential</i>)	████████
Pipe Vintage	1944
Construction Start	02/23/2015
Construction Finish	04/24/2015
Original Pipe Diameter (<i>confidential</i>)	████████
New Diameter (<i>confidential</i>)	N/A
Original SMYS ⁴ (<i>confidential</i>)	████████
New SMYS (<i>confidential</i>)	N/A

³ Ibid

⁴ Ibid

Pipeline Enhancement Plan Final Report
Line 404 Hydrotest and Replacement Projects

Table 1: General Project Information (Continued)

Project Name	Section 3A
Project Type	Replacement
Length	0.563 miles
Location	Ventura
Class	3
MAOP (<i>confidential</i>)	[REDACTED]
Pipe Vintage	1944
Construction Start	08/15/2016
Construction Finish	11/04/2016
Original Pipe Diameter (<i>confidential</i>)	[REDACTED]
New Diameter (<i>confidential</i>)	[REDACTED]
Original SMYS ⁵ (<i>confidential</i>)	[REDACTED]
New SMYS (<i>confidential</i>)	[REDACTED]
Project Name	Section 4 & 5
Project Type	Hydrotest
Length	7.315 miles
Location	Ventura
Class	3
MAOP (<i>confidential</i>)	[REDACTED]
Pipe Vintage	1944
Construction Start	09/21/2015
Construction Finish	11/24/2015
Original Pipe Diameter (<i>confidential</i>)	[REDACTED]
New Diameter (<i>confidential</i>)	N/A
Original SMYS ⁶ (<i>confidential</i>)	[REDACTED]
New SMYS (<i>confidential</i>)	N/A

⁵ Ibid

⁶ Ibid

Pipeline Enhancement Plan Final Report
Line 404 Hydrotest and Replacement Projects

Table 1: General Project Information (Continued)

Project Name		Section 8A		
Project Type		Replacement		
Length		0.009 miles		
Location		Moorpark		
Class		3		
MAOP (<i>confidential</i>)		[REDACTED]		
Pipe Vintage		1944		
Construction Start		02/13/2014		
Construction Finish		04/29/2014		
Original Pipe Diameter (<i>confidential</i>)		[REDACTED]		
New Diameter (<i>confidential</i>)		[REDACTED]		
Original SMYS ⁷ (<i>confidential</i>)		[REDACTED]		
New SMYS (<i>confidential</i>)		[REDACTED]		
Project Name		Section 9		
Project Type		Hydrotest		
Length		0.409 miles		
Location		Woodland Hills		
Class		3		
MAOP (<i>confidential</i>)		[REDACTED]		
Pipe Vintage		1944		
Construction Start		06/13/2016		
Construction Finish		08/12/2016		
Original Pipe Diameter (<i>confidential</i>)		[REDACTED]		
New Diameter (<i>confidential</i>)		N/A		
Original SMYS ⁸ (<i>confidential</i>)		[REDACTED]		
New SMYS (<i>confidential</i>)		N/A		
Project Costs (\$)		Capital	O&M	Total
Loaded Project Costs		13,847,661	12,484,239	26,331,900
Disallowed Costs		6,949	2,561	9,511

⁷ Ibid

⁸ Ibid

Pipeline Enhancement Plan Final Report
 Line 404 Hydrotest and Replacement Projects

B. Maps and Images

Figure 1: Overview Image of Line 404 Hydrotest and Replacement Projects

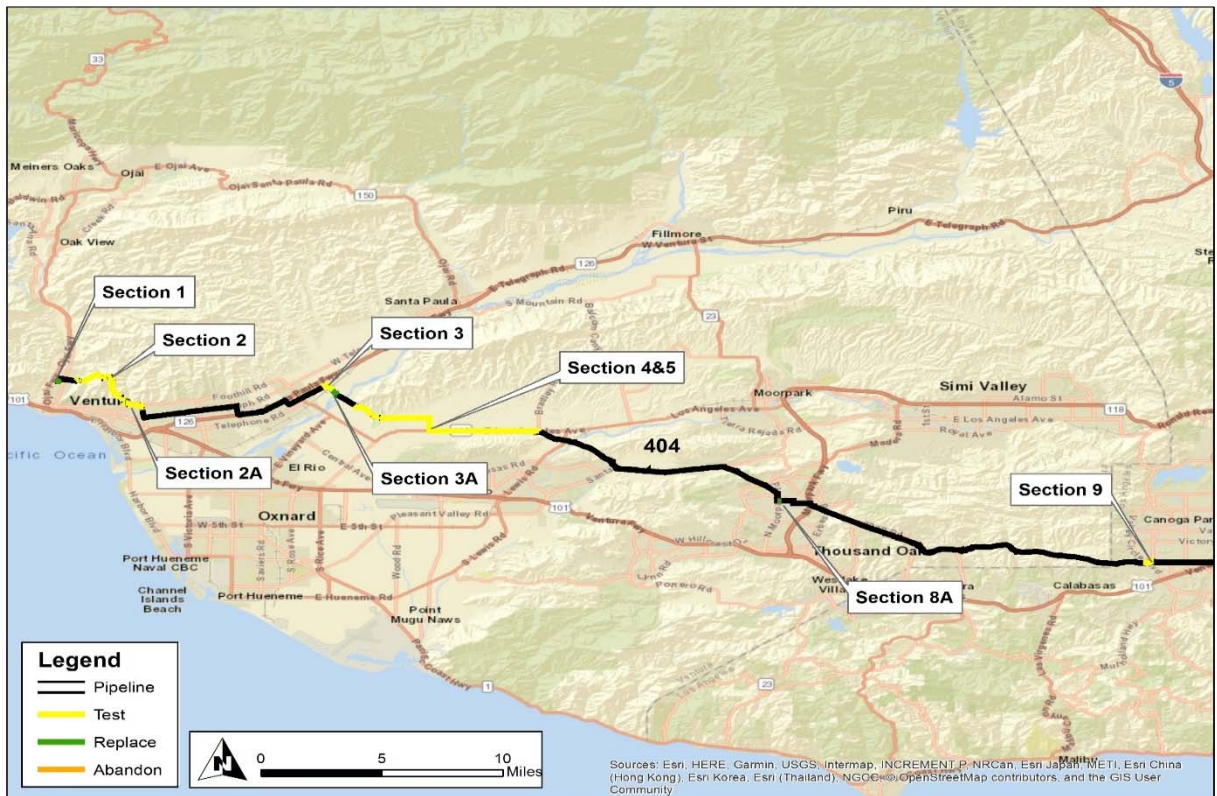

Pipeline Enhancement Plan Final Report
Line 404 Hydrotest and Replacement Projects

Figure 2: Satellite Image of Line 404 Section 1 Replacement Project

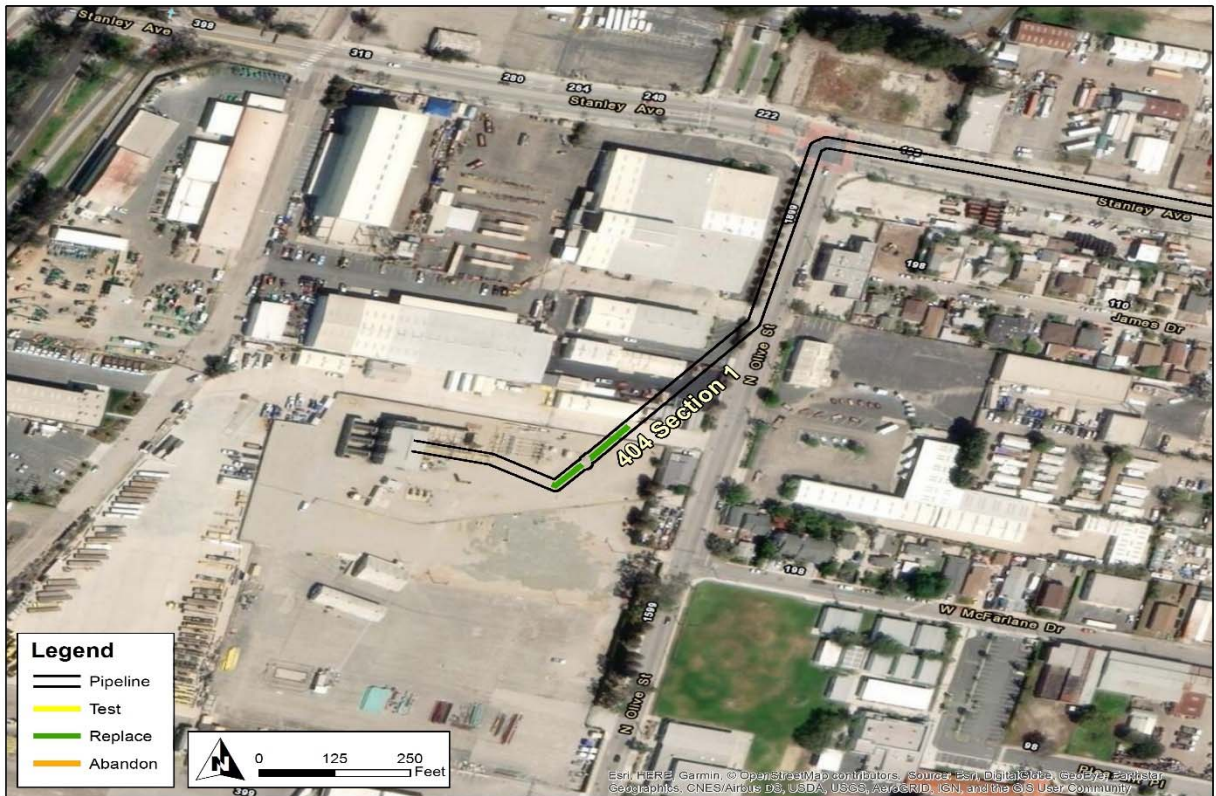

Pipeline Enhancement Plan Final Report
Line 404 Hydrotest and Replacement Projects

Figure 3: Overview Image of Line 404 Section 1 Replacement Project



Pipeline Enhancement Plan Final Report
Line 404 Hydrotest and Replacement Projects

Figure 4: Satellite Image of Line 404 Sections 2 and 2A Hydrotest Project

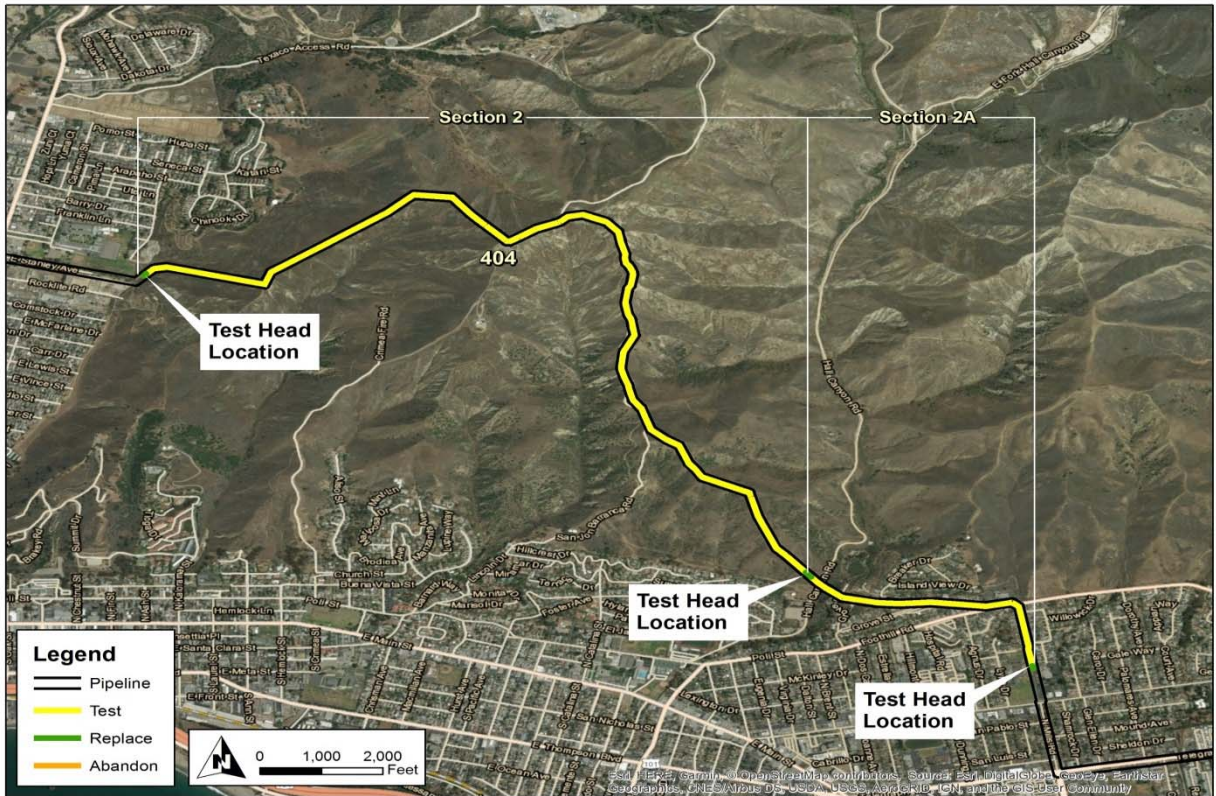

Pipeline Enhancement Plan Final Report
 Line 404 Hydrotest and Replacement Projects

Figure 5: Overview Image of Line 404 Sections 2 and 2A Hydrotest Project

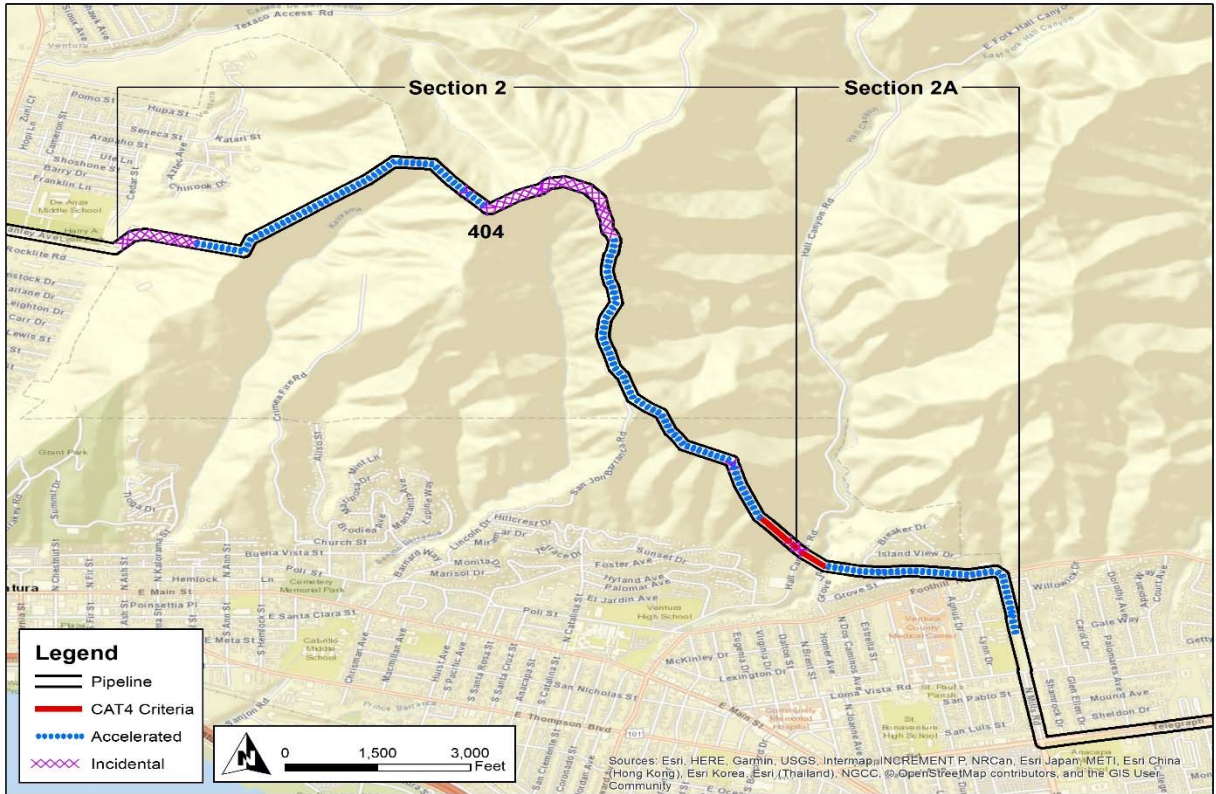

Pipeline Enhancement Plan Final Report
Line 404 Hydrotest and Replacement Projects

Figure 6: Satellite Image of Line 404 Sections 3 and 3A Hydrotest and Replacement Projects

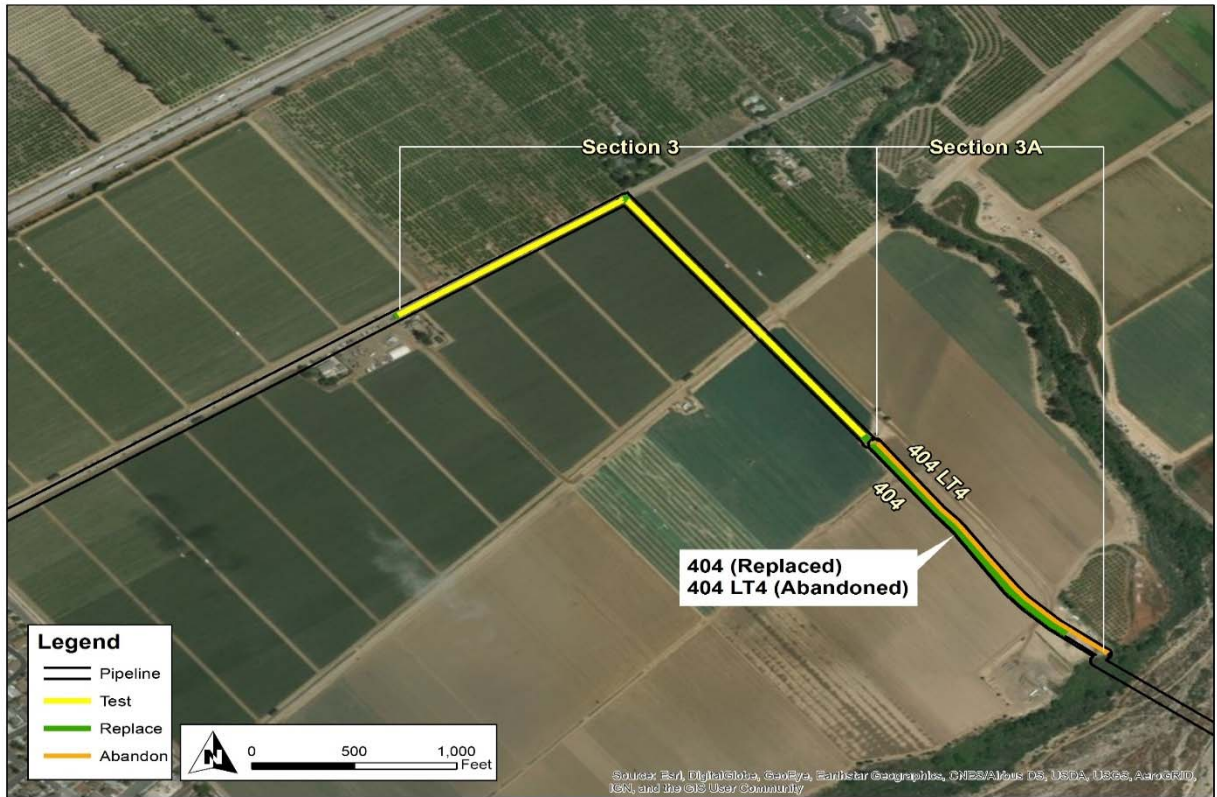

Pipeline Enhancement Plan Final Report
Line 404 Hydrotest and Replacement Projects

Figure 7: Overview Image of Line 404 Sections 3 and 3A Hydrotest and Replacement Projects

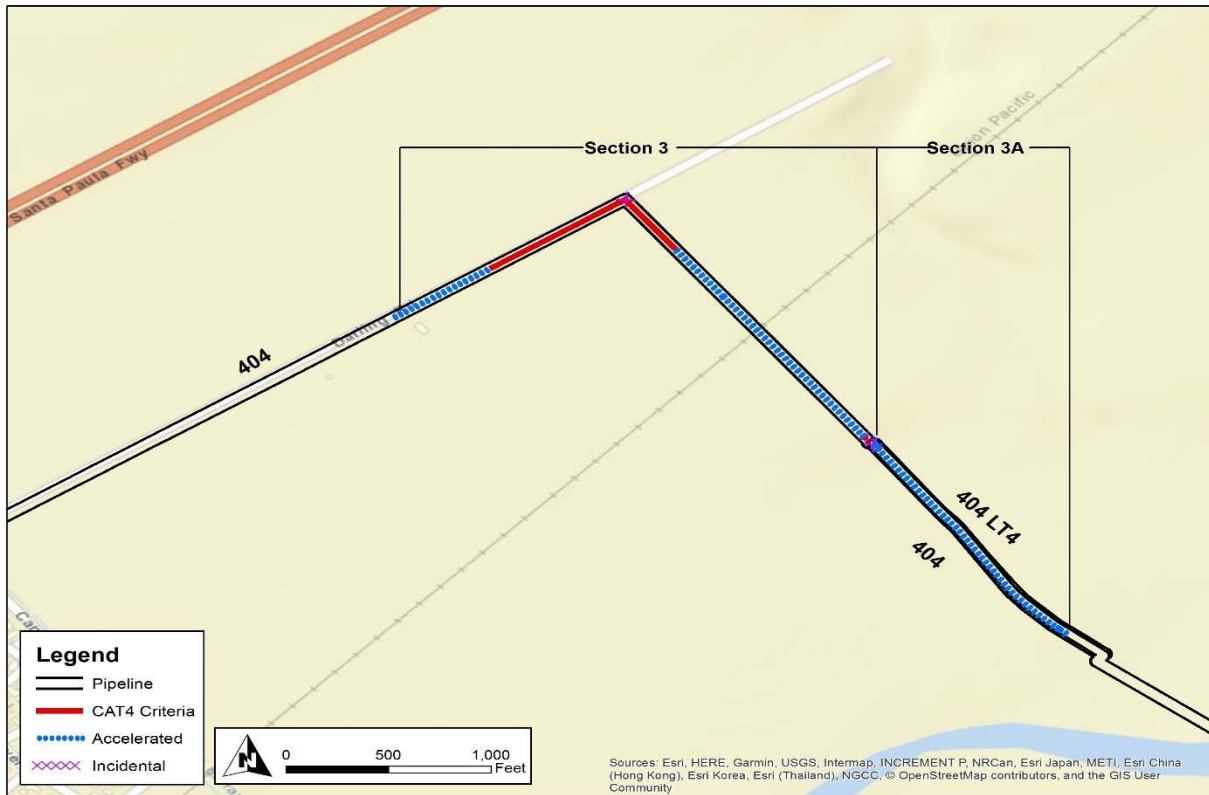

Pipeline Enhancement Plan Final Report
Line 404 Hydrotest and Replacement Projects

Figure 8: Satellite Image of Line 404 Section 4 and 5 Hydrotest Project

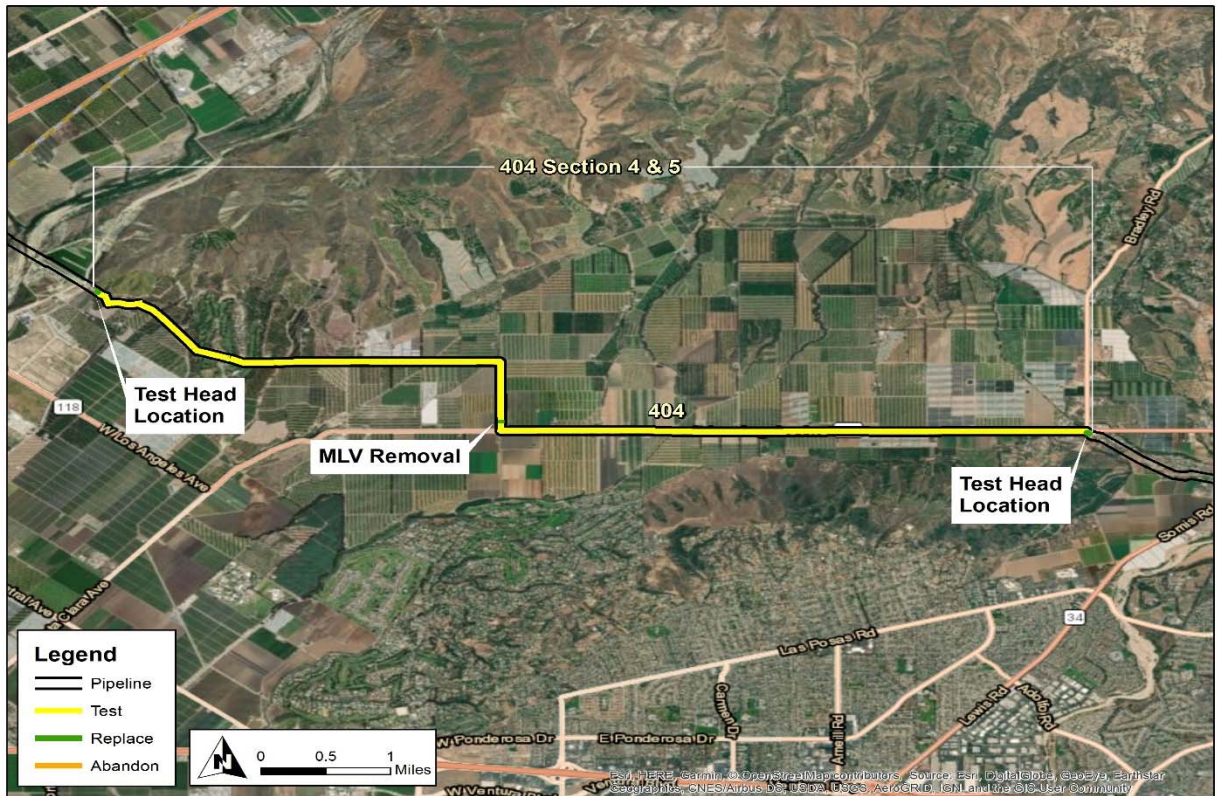

Pipeline Enhancement Plan Final Report
Line 404 Hydrotest and Replacement Projects

Figure 9: Overview Image of Line 404 Section 4 and 5 Hydrotest Project

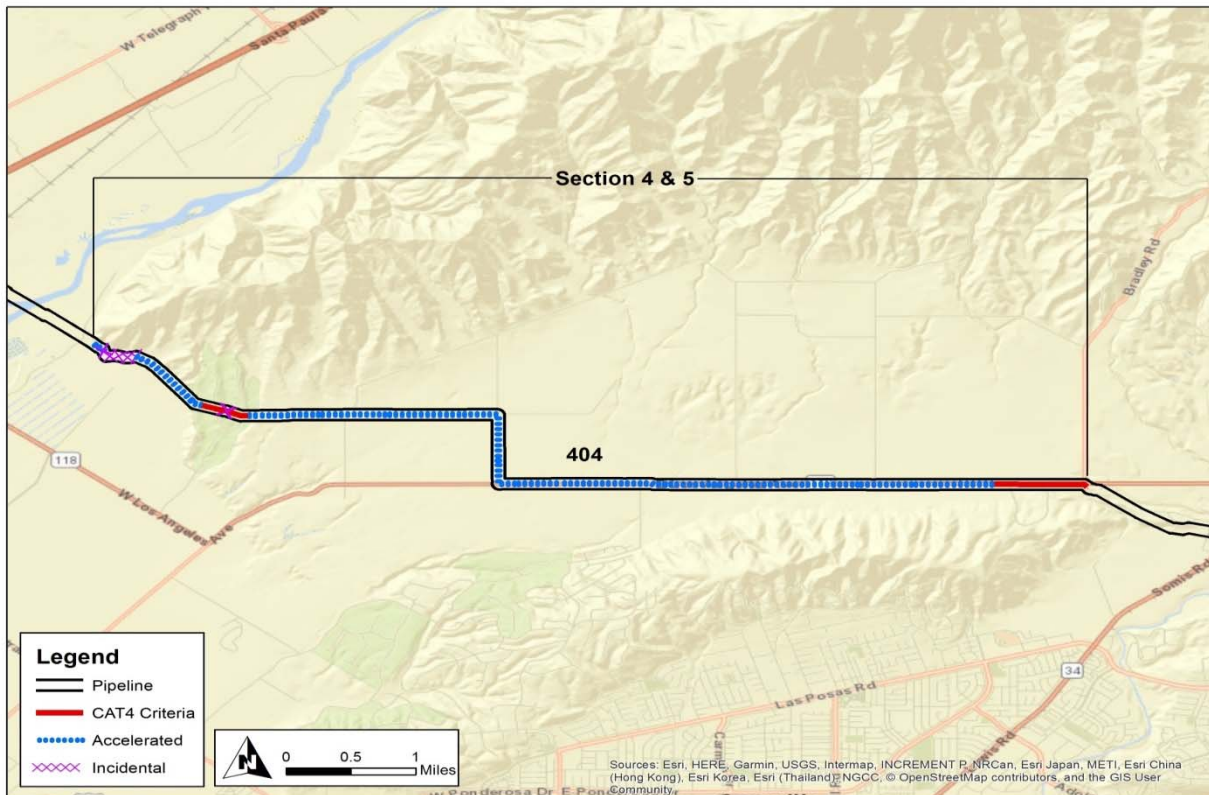

Pipeline Enhancement Plan Final Report
Line 404 Hydrotest and Replacement Projects

Figure 10: Satellite Image of Line 404 Section 8A Replacement Project



Pipeline Enhancement Plan Final Report
Line 404 Hydrotest and Replacement Projects

Figure 11: Overview Image of Line 404 Section 8A Replacement Project



Pipeline Enhancement Plan Final Report
Line 404 Hydrotest and Replacement Projects

Figure 12: Satellite Image of Line 404 Section 9 Hydrotest Project



Pipeline Enhancement Plan Final Report
Line 404 Hydrotest and Replacement Projects

Figure 13: Overview Image of Line 404 Section 9 Hydrotest Project



Pipeline Enhancement Plan Final Report
Line 404 Hydrotest and Replacement Projects

II. ENGINEERING, DESIGN, AND PLANNING

A. Project Scope

Table 2: Mileage Information

Replacement	Criteria	Accelerated	Incidental	New	Total
Section 1	0.026 mi.	0.002 mi.	0.000 mi.	0 mi.	0.028 mi.
	140 ft.	8 ft.	1 ft.	0 ft.	149 ft.
Section 3A	0 mi.	0.548 mi.	0.003 mi.	0.012 mi.	0.563 mi. ⁹
	0 ft.	2,892 ft.	17 ft.	63 ft.	2,972 ft.
Section 8A	0.006 mi.	0.002 mi.	0.001 mi.	0 mi.	0.009 mi.
	30 ft.	14 ft.	5 ft.	0 ft.	49 ft.
Subtotal	0.032 mi.	0.550 mi.	0.006 mi.	0.012 mi.	0.600 mi.
	170 ft.	2,906 ft.	31 ft.	63 ft.	3,170 ft.
Hydrotest	Criteria	Accelerated	Incidental	New	Total
Section 2	0.126 mi.	2.182 mi.	0.669 mi.	0 mi.	2.977 mi.
	662 ft.	11,520 ft.	3,531 ft.	1 ft.	15,714 ft.
Section 2A	0.116 mi.	0.698 mi.	0.003 mi.	0 mi.	0.817 mi.
	616 ft.	3,684 ft.	15 ft.	0 ft.	4,314 ft.
Section 3	0.223 mi.	0.314 mi.	0.001 mi.	0 mi.	0.538 mi.
	1,176 ft.	1,658 ft.	7 ft.	0 ft.	2,841 ft.
Section 4 & 5	0.937 mi.	6.108 mi.	0.265 mi.	0.006 mi.	7.315 mi.
	4,947 ft.	32,249 ft.	1,397 ft.	31 ft.	38,624 ft.
Section 9	0.177 mi.	0.232 mi.	0 mi.	0 mi.	0.409 mi.
	932 ft.	1,224 ft.	0 ft.	0 ft.	2,157 ft.
Subtotal	1.579 mi.	9.534 mi.	0.938 mi.	0.006 mi.	12.055 mi.
	8,333 ft.	50,335 ft.	4,950 ft.	32 ft.	63,650 ft.

⁹ Total Mileage for Section 3A includes both replacement and abandonment mileage of the dual piping.

Pipeline Enhancement Plan Final Report
Line 404 Hydrotest and Replacement Projects

Table 2: Mileage Information (Continued)

	Criteria	Accelerated ¹⁰	Incidental	New	Total ¹¹
Total Final Mileage	1.611 mi.	10.085mi.	0.942 mi.	0.018 mi.	12.655 mi.
	8,504 ft.	53,249 ft.	4,973 ft.	95 ft.	66,820 ft.

SoCalGas and SDG&E presented a conceptual project scope in workpapers supporting the 2011 PSEP filing¹². Prior to initiating execution of the Project in 2014, SoCalGas and SDG&E reviewed existing pipeline records to validate the scope of the Project. During the Engineering, Design, and Planning phase, SoCalGas and SDG&E further refined the scope. This progression of the project scope is summarized as follows:

1. 2011 PSEP Filing: SoCalGas and SDG&E identified Line 404 as a Phase 1A Hydrotest Project comprised of 24.450 miles of Category 4 Criteria pipe and 13.350 miles of Accelerated pipe.
2. Scope Validation: Through scope validation activities, after the 2011 filing and before initiating execution of the Project, SoCalGas and SDG&E successfully reduced the scope of the Line 404 Project by 22.616 miles of Category 4 Criteria pipe.

¹⁰ Accelerated mileage includes Phase 1B, Phase 2A, and Phase 2B pipe. Phase 2 includes pipelines without sufficient record of a pressure test in less populated areas (Phase 2A) or pipelines with record of a pressure test, but without record of a pressure test to modern – Subpart J – standards (Phase 2B). The Accelerated mileage was included to realize efficiencies and to enhance project constructability.

¹¹ Values may not add to total due to rounding.

¹² See Amended PSEP of SoCalGas and SDG&E, submitted December 2, 2011, in R.11-02-019 and subsequently transferred to A.11-11-002.

Pipeline Enhancement Plan Final Report
Line 404 Hydrotest and Replacement Projects

3. Engineering, Design, and Constructability: Due to the disparate locations of Category 4 segments along the length of the pipeline and for constructability reasons, SoCalGas and SDG&E strategically separated and executed the project in several sections:
- a. Section 1: Scoped as a replacement within and adjacent to SoCalGas and SDG&E's Ventura Compressor Station.
 - b. Section 2: Scoped as a hydrotest from mainline valve (MLV) 404-3.71-0 from Hall Canyon to Poinsettia Pavilion in the City of Ventura.
 - c. Section 2A: Originally scoped with Section 2 (above), and not separated until construction.
 - d. Section 3: Scoped as a hydrotest through agricultural land.
 - e. Section 3A: At the time, the 2011 PSEP filing did not identify Section 3A as a PSEP project. SoCalGas and SDG&E reviewed existing pipeline records and determined that Section 3A was within a Class 1 location and was composed of Phase 1B, non-piggable pipe that should be remediated as a Phase 1A project. Section 3A was scoped to include the replacement of two preexisting, non-piggable, pre-46 valves (MLV¹³ and cross-tie valve), and a replacement of dual run pipe with straight run pipe between SoCalGas and SDG&E's Santa Clara West Valve Station and an area north of the Santa Clara River.

¹³ See Final Report for Valve – 404-406 Ventura 2016 Bundle.

Pipeline Enhancement Plan Final Report
Line 404 Hydrotest and Replacement Projects

- f. Section 4 and Section 5: The sections were initially scoped and designed as two separate replacement projects. A subsequent review of the adjacent Accelerated mileage resulted in a reevaluation and Sections 4 and 5 were combined into a single hydrotest that incorporated the accelerated mileage that spanned the distance in between the two sections of Category 4 Criteria mileage:
 - i. Section 4 contained Category 4 Criteria and Accelerated pipe through agricultural land and a local golf course.
 - ii. Section 5 contained Category 4 Criteria and Accelerated pipe along Highway 118.
- g. Section 8A: Scoped as a replacement of Category 4 Criteria pipe within SoCalGas and SDG&E's Moorpark Station.
- h. Section 9: Scoped as a replacement of Category 4 Criteria pipe within and adjacent to SoCalGas and SDG&E's Westside Station.

For each of these sections, as engineering and design progressed, the Category 4 Criteria scope was further reduced, and Accelerated and Incidental scope was incorporated for constructability purposes.

- 4. Final Project Scope: The final project scope consists of the following:
 - a. Section 1: Consists of the replacement of approximately 149 feet of [REDACTED], [REDACTED], and [REDACTED] pipeline. The Accelerated mileage consists of 8 feet of Phase 2B pipe and 1 foot of Incidental pipe.
 - b. Section 2: Consists of a 2.976 mile hydrotest. The Accelerated mileage consists of 2.179 miles of Phase 2A pipe, 13 feet of Phase 2B pipe, and 0.669 miles of Incidental pipe.

Pipeline Enhancement Plan Final Report
Line 404 Hydrotest and Replacement Projects

- c. Section 2A: Consists of a 0.817 mile hydrotest and was separated from the Section 2 Hydrotest during construction. The Accelerated mileage consists of 0.698 miles of Phase 2B pipe and 15 feet of Incidental pipe.
- d. Section 3: Consists of a 0.538 mile hydrotest. The Accelerated mileage consists of 0.225 miles of Phase 2A pipe, 0.089 miles of Phase 2B pipe and 13 feet of Incidental pipe.
- e. Section 3A: Consists of a 0.563 mile replacement of dual run [REDACTED] pipe with a single run [REDACTED] diameter line for piggability. The Accelerated mileage consists of 0.530 miles of Phase 1B pipe, 34 feet of Phase 2A pipe, 57 feet of Phase 2B pipe, and 17 feet of Incidental pipe.
- f. Section 4 and 5: Consists of a 7.315 mile hydrotest, along with the replacement of two non-piggable features (non-barred tee and [REDACTED] plug valve). The Accelerated mileage consists of 6.108 miles of Phase 1B pipe, and 0.265 miles of Incidental pipe.
- g. Section 8A: Consists of a 49-foot replacement. The Accelerated mileage consists of 9 feet of Phase 1B pipe, 5 feet of Phase 2B pipe, and 5 feet of Incidental pipe.
- h. Section 9: Consists of a 0.409 mile hydrotest. The Accelerated mileage consists of 0.232 miles of Phase 2B pipe, and there was no Incidental pipe.

Pipeline Enhancement Plan Final Report
Line 404 Hydrotest and Replacement Projects

B. Decision Tree Analysis

SoCalGas and SDG&E performed a PSEP Decision Tree analysis for each of the Line 404 Sections and confirmed the remediation method for each project design. Through the Decision Tree analyses, SoCalGas and SDG&E identified the more prudent option for each of the individual sections. Key considerations that support SoCalGas and SDG&E's determination for each of these sections are as follows:

Segments less than 1,000 feet

Segments of less than 1,000 feet are identified for replacement under the approved PSEP Decision Tree because, for short segments of pipe, the logistical costs associated with pressure testing (for example, permitting, construction, water handling, and service disruptions for a non-looped system) can approach or exceed the cost of replacement. In such circumstances, replacement affords a more cost-effective approach to achieving compliance with D.11-06-017 while providing equal safety enhancement benefits. Moreover, installation of the new segment can usually be performed while the existing service is maintained to customers, thereby avoiding service disruptions that may otherwise occur during pressure testing.

Section 1

1. Pipe Vintage: 1944.
2. Piggability: Piggable.
3. Longseam Type: Seamless.
4. Longseam Repair History: No identified issues.
5. Condition of Coating: No identified issues.

Pipeline Enhancement Plan Final Report
Line 404 Hydrotest and Replacement Projects

6. History of Leaks: No identified issues.

Section 8A:

1. Pipe Vintage: 1944.
2. Piggability: Piggable.
3. Longseam Type: Seamless.
4. Longseam Repair History: No identified issues.
5. Condition of Coating: No identified issues.
6. History of Leaks: No identified issues.

Segments longer than 1000 feet:

Although installed prior to 1946 and identified for replacement under the approved PSEP Decision Tree based on vintage, it was determined that Line 404 is capable of being assessed using in-line inspection (ILI) technology. The most recent ILI data confirmed that the pipeline is in good condition and can continue to operate safely as part of the routine pipeline maintenance program. The ILI capability and pipe condition, along with consideration that the estimated costs to hydrotest is lower, the impact to the community would be less in comparison to a replacement, test ends could be located in relatively non-impactful areas, and customer service outages are expected to be manageable, SoCalGas and SDG&E decided that hydrotesting would be the prudent path forward. SoCalGas and SDG&E completed a preliminary review to determine whether SoCalGas and SDG&E can manage customer service impacts if the pipeline segment is taken out of service for a period of two to six weeks to complete pressure testing.

Pipeline Enhancement Plan Final Report
Line 404 Hydrotest and Replacement Projects

Where mitigation of customer impacts to remove the line from service for pressure testing is feasible, SoCalGas and SDG&E compare the costs, constructability, risks, and benefits of pressure testing and replacement to determine whether pressure testing or replacement is the more prudent option.

Section 2 (and 2A):

1. Pipe Vintage: 1944.
2. Piggability: Piggable.
3. Longseam Type: Seamless.
4. Longseam Repair History: No identified issues.
5. Condition of Coating: No identified issues.
6. History of Leaks: No identified issues.

Section 3:

1. Pipe Vintage: 1944.
2. Piggability: Piggable.
3. Longseam Type: Seamless.
4. Longseam Repair History: No identified issues.
5. Condition of Coating: Fair.
6. History of Leaks: No identified issues.

Pipeline Enhancement Plan Final Report
Line 404 Hydrotest and Replacement Projects

Section 3A:

1. Pipe Vintage: 1944.
2. Piggability: Non-piggable.
3. Existing Pipe Attributes: This section is non-piggable due to tees and diameter changes. The pipeline transitions from [REDACTED] pipe to dual [REDACTED] pipes that come back together at a tee, and then expands up to [REDACTED] diameter.
4. Longseam Type: Seamless.
5. Longseam Repair History: No identified issues.
6. Condition of Coating: Fair.
7. History of Leaks: No identified issues.

Section 4 and 5:

1. Pipe Vintage: 1944.
2. Piggability: Non-piggable.
3. Existing Pipe Attributes: A preexisting non-piggable MLV and unbarred tee was identified for replacement to make the line piggable. Various wrinkle bends were identified, but these features did not make the line non-piggable.
4. Longseam Type: Seamless.
5. Longseam Repair History: No identified issues.
6. Condition of Coating: No identified issues.
7. History of Leaks: No identified issues.

Pipeline Enhancement Plan Final Report
Line 404 Hydrotest and Replacement Projects

Section 9:

1. Pipe Vintage: 1944.
2. Piggability: Piggable.
3. Existing Pipe Attributes: Various wrinkle bends were identified but these features did not make the line non-piggable.
4. Longseam Type: Seamless.
5. Longseam Repair History: No identified issues.
6. Condition of Coating: No identified issues.
7. History of Leaks: No identified issues.

C. Engineering, Design, and Planning Factors

SoCalGas and SDG&E reviewed pipeline drawings and other information, contacted internal planning groups, communicated with external stakeholders, conducted survey activities, including reviewing public records and potholing of the area to confirm the presence of underground utilities and substructures, and completed a pre-design site walk. Key factors that influenced the engineering and design of the Project are as follows:

Section 1:

1. Shut-In Analysis: The Project Team completed a Request for Engineering Review (RER) analysis and concluded that the line could be shut-in as long as adjacent Line 406 was in service.

Pipeline Enhancement Plan Final Report
Line 404 Hydrotest and Replacement Projects

2. Customer Impacts: Per the RER, there were no core customers served by the line within the shut-in limits. Service to non-core customers could be maintained by advance notification or coordination with customer shut-in.
3. Known Substructures: Original pipe depth was assumed to be 7 feet; however, once potholing was completed it was confirmed that pipe depth was approximately 10 feet.
4. Permit Conditions: No permitting conditions were identified as all work would occur within SoCalGas and SDG&E property.
5. Land Use:
 - a. Laydown yard usage within SoCalGas and SDG&E's Ventura Compressor Station was to be shared with Line 404 Section 2;
 - b. SoCalGas compressor station was to be used as an active yard for fabrication;
 - c. Adjacent property will only require notification of maintenance to landowner and no temporary right of entry (TRE) was required.
6. Environmental: Abatement activities were anticipated for asbestos containing materials (ACMs) and paint. A soil management plan was developed for potentially contaminated soil.
7. Reroute: No reroutes were identified as the replacement is in situ.

Pipeline Enhancement Plan Final Report
Line 404 Hydrotest and Replacement Projects

Section 2 (and 2A):

1. **Shut-In Analysis:** The Project Team completed an RER analysis and concluded that the line could be shut-in as long as the adjacent Line 406 was in service.
2. **Customer Impacts:** Per the RER, there were no core customers served by the line within the shut-in limits. Service to non-core customers could be maintained by advance notification or coordination with customer shut-in. As an additional option, a permanent MLV bypass was proposed for a non-core customer.
3. **Permit Conditions:** There were no permitting conditions identified, as all work would occur within existing easements inside the SoCalGas property. A Storm Water Pollution Prevention Plan (SWPPP) was obtained through the State Water Resources Control Board for obtaining the proposed permanent MLV bypass.
4. **Land Use:** The Section 2 laydown yard was to be shared with Section 1. The Section 2A laydown yard was located on SoCalGas right of way (ROW).
5. **Environmental:** Abatement activities were anticipated for ACMs and paint coating. A SWPPP would be filed.

Section 3:

1. **Shut-In Analysis:** The Project Team completed an RER analysis and concluded that the line could be shut-in as long as the adjacent Line 406 was in service.
2. **Customer Impacts:** There were no non-core customers served by the line within the shut-in limits. Service to core customers could be maintained by compressed natural gas (CNG).

Pipeline Enhancement Plan Final Report
Line 404 Hydrotest and Replacement Projects

3. Permit Conditions: Permits were anticipated from Ventura County for traffic control plans at the test head site and laydown yard.
4. Environmental: Abatement activities were anticipated for ACMs and paint coating.

Section 3A:

1. Shut-In Analysis: The Project Team completed an RER analysis and concluded that the line could be shut-in as long as the adjacent Line 406 was in service.
2. Customer Impacts: There were no non-core customers served by the line within the shut-in limits. Service to core customers could be maintained by CNG.
3. Diameter Changes: [REDACTED] dual run to a [REDACTED] single run.
4. Known Substructures: Potholing was completed to verify the depth of the proposed south tie-in that was located deeper than anticipated.
5. Environmental:
 - a. The following biological resources were anticipated as some of the work areas were near or within the following jurisdictions:
 - i. Wetland and non-wetland waters under various federal and state jurisdictions, that could require the acquisition of federal and state jurisdictional wetland and non-wetland waters permits.
 - ii. Mapped Oak Woodland areas required coordination with the City of Ventura and unincorporated Ventura County if work areas were within the vicinity.
 - iii. Further permitting with various federal and state jurisdictions (identified above), along with the local city and county if work areas were within riparian habitat associated with water bodies mapped along the pipeline.

Pipeline Enhancement Plan Final Report
Line 404 Hydrotest and Replacement Projects

- iv. Environmentally Sensitive Areas (ESAs) – Several previous studies bisect the pipeline segment. There are known archaeological sensitivities in the vicinity of the pipeline.
 - b. Abatement activities were anticipated for asbestos containing materials and paint coating. A SWPPP will also be filed.
6. Valves: Two preexisting non-piggable, pre-46 valves (MLV and cross-tie valve) were to be replaced.

Section 4 and 5:

1. Shut-In Analysis: The Project Team completed an RER analysis and concluded that the line could be shut-in as long as the adjacent Line 406 was in service.
2. Customer Impacts: There were no non-core customers served by the line within the shut-in limits. Service to core customers could be maintained by CNG.
3. Permit Conditions:
 - a. Caltrans permits were required for traffic control along Highway 118, and closure of a nearby road.
 - b. An encroachment permit for the CNG trailer was required along the road to support the regulator station and closure of a nearby road for non-piggable MLV removal from Ventura County.
4. Land Use: A notification of maintenance was required for the upstream test head if planned to use in an existing easement on private property.

Pipeline Enhancement Plan Final Report
Line 404 Hydrotest and Replacement Projects

5. Environmental: Abatement activities were anticipated for ACMs and paint coating. A permitted waterway (unnamed tributary to the Santa Clara River) was excluded from the work zone.
6. Valves: A preexisting non-piggable MLV was to be removed.

Section 8A:

1. Shut-In Analysis: The Project Team completed an RER analysis and concluded that the line could be shut-in as long as adjacent Line 406 was in service.
2. Customer Impacts: There were no core or non-core customers served by the line within the shut-in limits.
3. Permit Conditions: There were no permitting conditions as all work would occur within existing easements within the SoCalGas property.

Section 9:

1. Shut-In Analysis: The Project Team completed an RER analysis and concluded that the line could be shut-in as long as the adjacent Line 406 was in service.
2. Customer Impacts: There were no non-core customers served by the line within the shut-in limits. Core customers were not impacted as the tap within the shut-in limits are bridled with adjacent Line 406.
3. Permit Conditions: Long lead permits were anticipated from the City of Los Angeles for a two-lane road closure on Burbank Boulevard for the duration of the project to facilitate excavations and space to be used as a laydown yard.

Pipeline Enhancement Plan Final Report
Line 404 Hydrotest and Replacement Projects

4. Land Use: Laydown yard usage was shared with PSEP Project Line 406 Section 3.
5. Environmental:
 - a. Hydrotest water was reused from the PSEP Project Line 406 Section 3. After the test, the water would either be treated and discharged or disposed of at a company approved treatment and disposal facility.
 - b. Abatement activities were anticipated for ACMs and paint coating.

D. Scope Changes

Through engineering, design, and planning activities, SoCalGas and SDG&E determined that changes in scope were appropriate to enhance the design of the Project and address engineering factors. As a result, the preliminary cost estimate does not fully reflect the final scope. Summarized below are notable changes in scope made after the preliminary cost estimate was developed and approved.

1. Section 2A: Section 2A was separated from Section 2 when an agreement could not be reached on a permanent bypass to keep a non-core customer in service. Construction was then deferred to coincide with the non-core customer's maintenance outage that occurs once every two years.
2. Section 4 and 5: Originally planned as two separate replacements, Section 4 through a golf course and Section 5 along Highway 118. The scope was reevaluated by the Project Team when it was determined that the five miles of Accelerated Category 4 pipe in Class 1 and Class 2 locations that spanned the distance between Section 4 and 5, could be remediated in a hydrotest, and more cost effectively in comparison to two separate replacements.

Pipeline Enhancement Plan Final Report
Line 404 Hydrotest and Replacement Projects

3. Section 9: Originally planned with the Line 406 Section 3 Project and as a replacement, SoCalGas and SDG&E determined that hydrotesting was the most prudent option as the Project Team would not need to relocate overhead utilities, there would be less impact to the residences as no relocation would be required, and reduced scope, such as the efforts required for excavations, staging, and permitting costs.

Pipeline Enhancement Plan Final Report
Line 404 Hydrotest and Replacement Projects

III. CONSTRUCTION

A. Construction Contractor Selection

The Project Team prepared an initial cost estimate based on the preliminary design for seven of the eight project sections. Section 8A was excluded from the estimate because it was a short replacement incorporated into an adjacent Pipeline Integrity project under construction. Following completion of the engineering, design, and planning activities described above, the Project Team directed the Performance Partner to prepare cost estimates based on a more detailed engineering design package, that included the updated design described in the discussion of notable Scope Changes above. SoCalGas and SDG&E awarded the construction contract to the Performance Partner.

1. SoCalGas and SDG&E's Preliminary Construction Cost Estimate (*confidential*):

SoCalGas and SDG&E's preliminary cost estimate for construction was

██████████.

2. Construction Contractor's Target Price Estimate (*confidential*): The Construction

Contractor's cost estimate was ██████████, which was ██████████ than SoCalGas and SDG&E's preliminary cost estimate for construction.

Pipeline Enhancement Plan Final Report
Line 404 Hydrotest and Replacement Projects

B. Construction Schedule

Table 3: Construction Timeline

Section 1	
Construction Start Date	09/22/2015
Construction Completion Date	11/24/2015
NOP Date	11/12/2015
Section 2	
Construction Start Date	09/22/2015
Construction Completion Date	12/22/2015
NOP Date	11/12/2015
Section 2A	
Construction Start Date	03/20/2017
Construction Completion Date	07/13/2017
NOP Date	04/24/2017
Section 3	
Construction Start Date	02/23/2015
Construction Completion Date	04/24/2015
NOP Date	03/31/2015
Section 3A	
Construction Start Date	08/15/2016
Construction Completion Date	11/04/2016
NOP Date	10/06/2016
Section 4 and 5	
Construction Start Date	09/21/2015
Construction Completion Date	11/24/2015
NOP Date	10/31/2015
Section 8A	
Construction Start Date	02/13/2014
Construction Completion Date	04/29/2014
NOP Date	03/20/2014
Section 9	
Construction Start Date	06/13/2016
Construction Completion Date	08/12/2016
NOP Date	07/27/2016

Pipeline Enhancement Plan Final Report
Line 404 Hydrotest and Replacement Projects

C. Changes During Construction

The conditions summarized below were encountered during construction. Activities to address or mitigate these conditions resulted in approximately \$16,000 in credits.

Section 1:

1. Site Conditions: During excavation activities within the station, boulders and cobbles were encountered and were not apparent in the soil samples collected during planning and design. Due to the inability to reschedule the isolation work without impacting the overall schedule of this project and an adjacent project (Section 2), additional laborers were brought in to expedite hand digging.
2. Tie-In: During welding activities for the tie-in, porosity of the welding bead lead to some welds requiring repairs.

Section 2:

1. Scope Removal: Elimination/descope of one of the two hydrotests resulted in:
 - a. Removal of one of the two planned hydrotests.
 - b. Removal of the permanent bypass from scope.

Section 4 and 5:

1. Tie-In: During tie-in, a weld failed an x-ray inspection, necessitating a repair. The original bid assumed 16 hours for repairs, but additional hours were required.
2. Gas Handling: The original bid assumed 12 hours for isolation. Additional hours were required.
3. Environmental: Due to tar debris encountered during excavation, additional sampling, oversight, and abatement support was required. The soil required proper management and disposal.

Pipeline Enhancement Plan Final Report
Line 404 Hydrotest and Replacement Projects

Traffic Control: A traffic flagger was brought in for approximately two weeks as an additional preventative measure to prevent potential traffic issues.

Sections 2A, 3, 3A, 8A, and 9:

SoCalGas and SDG&E successfully mitigated conditions during construction in a manner that minimized potential impacts on project scope, cost, and schedule. As a result, these conditions did not result in any notable change orders.

Pipeline Enhancement Plan Final Report
Line 404 Hydrotest and Replacement Projects

Figure 14: Section 1 Abatement Activities



Pipeline Enhancement Plan Final Report
Line 404 Hydrotest and Replacement Projects

Figure 15: Section 1 Pre-fabrication of Replacement Pipe



Pipeline Enhancement Plan Final Report
Line 404 Hydrotest and Replacement Projects

Figure 16: Section 1 Existing Wall Footing Within Trench



Pipeline Enhancement Plan Final Report
Line 404 Hydrotest and Replacement Projects

Figure 17: Section 2 West Tie-in Piece Along Hill Side



Pipeline Enhancement Plan Final Report
Line 404 Hydrotest and Replacement Projects

Figure 18: Section 2 Hydrotest Prep at Hall Canyon Site



Pipeline Enhancement Plan Final Report
Line 404 Hydrotest and Replacement Projects

Figure 19: Section 2A Cut and Cap Activities



Pipeline Enhancement Plan Final Report
Line 404 Hydrotest and Replacement Projects

Figure 20: Section 2A Test Head Installation at Hall Canyon Site



Pipeline Enhancement Plan Final Report Line 404 Hydrotest and Replacement Projects

Figure 21: Section 3 Test Head Loop Being Lowered at MLV Site



Pipeline Enhancement Plan Final Report
Line 404 Hydrotest and Replacement Projects

Figure 22: Section 3 Coating Inspection at Tie-in Point



Pipeline Enhancement Plan Final Report Line 404 Hydrotest and Replacement Projects

Figure 23: Section 3A Abatement Activities of MLV Removal



Pipeline Enhancement Plan Final Report
Line 404 Hydrotest and Replacement Projects

Figure 24: Section 4 and 5 West End Test Head Excavation



Pipeline Enhancement Plan Final Report
Line 404 Hydrotest and Replacement Projects

Figure 25: Section 4 and 5 Removal of Existing Pipe Prior to Test Head Installation



Pipeline Enhancement Plan Final Report Line 404 Hydrotest and Replacement Projects

Figure 26: Section 9 Preparation of Isolation Caps



Pipeline Enhancement Plan Final Report
Line 404 Hydrotest and Replacement Projects

D. Commissioning and Site Restoration

Commissioning activities include restoration of the site, final inspection and placement of the pipeline back into service, transportation, and disposal of hydrotested water and hazardous material, and site demobilization. Closeout activities include development of final drawings, finalization of a reconciliation package, and updates to company recordkeeping systems to reflect the completed scope of work.

Pipeline Enhancement Plan Final Report
Line 404 Hydrotest and Replacement Projects

IV. PROJECT COSTS

A. Cost Avoidance Actions

SoCalGas and SDG&E exercised due diligence in the planning, design, and construction activities for this project to minimize or avoid costs when prudent to do so. As discussed above, the Project Team conducted a site visit to identify and incorporate discernible site conditions into the engineering, design, and planning of the Project. Specific examples of cost avoidance actions taken on this project are:

1. Scope Change:
 - a. Sections 4 and 5 were executed as one hydrotest rather than two replacement projects, saving on overall construction costs. Pre-hydrotest preparation rendered the pipeline piggable for future ILI.
 - b. Section 9 was executed as a hydrotest rather than a replacement.
2. Engineering and Design:
 - a. The test ends for Section 3 were sited intentionally to incorporate Phase 1B and Phase 2 pipe, accelerating future PSEP projects and eliminating two future projects, remobilizations and customer impacts.
3. Planning and Coordination:
 - a. Construction was coordinated and resources were shared for Sections 1 and 2.
 - b. Section 8A was incorporated into a Pipeline Integrity project.
 - c. Section 9 and Line 406 Section 3 utilized the same permits, construction crews, and equipment.

Pipeline Enhancement Plan Final Report
Line 404 Hydrotest and Replacement Projects

4. Materials:

- a. Bulk ordered pipe provided volume pricing for the [REDACTED] pipe.
- b. Built an inventory of test heads and isolation caps for reuse among projects.

5. Construction Execution:

- a. Removed non-piggable MLV in Section 4 and 5.

6. Land Use:

- a. Shared laydown yard for Sections 1 and 2.
- b. Shared laydown yard for Section 9 and Line 406 Section 3 Hydrotest Project.

7. Water Management:

- a. Reuse of hydrotest water for Sections 1 and 2.
- b. Reuse of hydrotest water for Sections 3 and 8.
- c. Reuse of hydrotest water for Section 9 and Line 406 Section 3 Project.

Pipeline Enhancement Plan Final Report
Line 404 Hydrotest and Replacement Projects

B. Cost Estimate

Based on the preliminary design, once the project scope was confirmed and engineering, design, and planning activities were underway, SoCalGas and SDG&E prepared an estimate of the Direct Costs of the Project in the amount of \$30,228,458.

The estimates for each of the sections were prepared starting in December 2014, using the “SCG Pipeline Estimate Template Rev 0”¹⁴ estimating tool, the most current version of the PSEP Estimate Template at the time.

The Project Team considered the conditions known at the time to prepare the preliminary Direct Cost estimate. This estimate reflects the projected Labor, Material, and Services costs anticipated to be incurred to execute the Project.

SoCalGas and SDG&E estimated Indirect Costs of the Project based on the estimated Direct Costs and other project-related variables.

C. Actual Direct and Indirect Costs

Actual Direct Costs reflect the Labor, Material, and Service costs incurred to execute the Project. Actual Indirect Costs reflect costs for incremental overhead loaders in accordance with Company overhead allocation policies. The total loaded cost of the Project is \$26,331,900.

¹⁴ The most current version of the tool was used throughout the planning and development of the estimates; versions of the estimating tool varied from Rev 0 to Rev 3.

Pipeline Enhancement Plan Final Report
Line 404 Hydrotest and Replacement Projects

Table 4: Estimated and Actual Direct Costs and Variances

Direct Costs (\$)	Estimate	Actuals	Delta Over/(Under)
Company Labor	1,882,086	1,244,950	(637,136)
Materials	1,687,558	694,600	(992,958)
Construction Contractor	15,620,494	8,088,366	(7,532,128)
Construction Management & Support	1,142,858	2,933,002	1,790,144
Environmental	751,629	1,538,122	786,493
Engineering & Design	4,071,160	4,699,225	628,065
Project Management & Services	1,266,580	2,136,232	869,652
ROW & Permits	606,792	119,233	(487,559)
GMA	3,199,301	2,769,737	(429,564)
Total Direct Costs	30,228,458	24,223,467	(6,004,991)

Table 5: Estimated and Actual Indirect Costs, Total Costs, and Variances

Indirect Costs/Total Costs (\$)	Estimate	Actuals	Delta Over/(Under)
Overheads	3,432,830	1,950,351	(1,482,479)
AFUDC	461,459	133,022	(328,437)
Property Taxes	103,256	25,060	(78,196)
Total Indirect Costs	3,997,545	2,108,433	(1,889,112)
Total Direct Costs	30,228,458	24,223,467	(6,004,991)
Total Loaded Costs	34,226,003	26,331,900	(7,894,103)

Pipeline Enhancement Plan Final Report
Line 404 Hydrotest and Replacement Projects

D. Disallowance

For this hydrotest project, SoCalGas and SDG&E identified a total of 31 feet of pipe as installed post-1955 and lacking pressure test records that provide the minimum information to demonstrate compliance with industry standards or then-applicable strength testing and recordkeeping requirements. Of the 12 miles of pipeline that were pressure tested, 13 feet (0.02%) of test mileage are disallowed, therefore \$2,561 of total project O&M costs are disallowed from recovery. In addition, of the pipeline that was replaced, 17.5 feet of Phase 1A pipe are disallowed. Therefore, a \$6,949 reduction was made to ratebase calculated by determining the replacement mileage and multiplying the amount by \$2,105,878 per mile, which was SoCalGas' and SDG&E's system average cost of pressure testing.

Pipeline Enhancement Plan Final Report
Line 404 Hydrotest and Replacement Projects

V. CONCLUSION

SoCalGas and SDG&E enhanced the safety of their integrated natural gas transmission system by prudently executing the Line 404 Hydrotest and Replacement Projects.

Through these Hydrotest and Replacement Projects, SoCalGas and SDG&E successfully hydrotested of approximately 12 miles of pipeline and replaced approximately 0.3 miles of pipeline that was managed and executed in eight sections through the Cities of Ventura, unincorporated Ventura County, Somis, Moorpark, and Woodland Hills. The total loaded cost of the Project is \$26,331,900.

SoCalGas and SDG&E executed this project prudently by pursuing opportunities to change scope when options were presented for testing versus replacement, resulting in the least cost option, and avoiding environmentally sensitive areas.

SoCalGas and SDG&E engaged in prudent cost avoidance efforts by sharing company and contractor resources along with laydown yards, utilizing bulk material purchases, reusing test heads and water for hydrotests, pursuing opportunities to change scope to select the least cost option, and enhancing piggability for future safety and maintenance activities, reducing future maintenance and operating costs.

End of Line 404 Hydrotest and Replacement Projects Final Report

I. LINE 1004 HYDROTEST AND REPLACEMENT PROJECT

A. Background and Summary

Line 1004 is a predominantly [REDACTED] diameter transmission line that runs approximately 35 miles from the Goleta Storage Field to the Ventura Compressor Station. The pipeline is primarily routed across a Class 3 location. This report describes the activity associated with the Line 1004 Hydrotest (Section 1) and the Line 8119 Replacement (Section 2) Project. Section 1 includes two hydrotests spanning approximately 8.7 miles, a relocation of a mainline valve (MLV), and the completion of the abandonment of crossover Line 1215 and crossover Line 1216. Section 2 describes the activities associated with the installation of a new crossover line, Line 8119, to replace the two abandoned crossover lines. The specific attributes of this Project are detailed in Table 1 below. The total loaded cost of the Project is \$14,019,777.

This Project was coordinated with the Line 1005 Replacement Project¹, that was executed first due to capacity constraints (one line needs to remain operational while the other is in service). Consistent with the overarching objectives of PSEP, during the planning of the PSEP projects in this area, SoCalGas and SDG&E coordinated the planning and execution of Line 1004, Line 1005, and construction of crossover Line 8119 to minimize customer impacts and maximize efficiencies. To minimize blowdowns and operational impacts, SoCalGas and SDG&E executed construction of the two projects sequentially, completing construction of the Line 1005 Replacement Project first. SoCalGas and SDG&E managed the Line 1004 Hydrotest and Replacement Project as a single project, with the costs of completing construction of both Section 1 and Section 2 combined.

¹ The Line 1005 Replacement Project was completed in 2014 and submitted for reasonableness review in A.16-09-005. The scope consisted of the replacement of two pipeline segments, the relocation of a mainline valve, and partial abandonment of Crossover Lines 1215 and 1216.

Pipeline Safety Enhancement Plan Final Report
Line 1004 – Hydrotest and Replacement Project

Table 1: General Project Information

Project Name		Line 1004 Hydrotest Section 1		
Project Type		Hydrotest		
Length		8.603 miles		
Location		Carpinteria		
Class		3		
MAOP (<i>confidential</i>)		[REDACTED]		
Pipe Vintage		1945		
Construction Start		05/11/2015		
Construction Finish		11/15/2015		
Original Pipe Diameter (<i>confidential</i>)		[REDACTED]		
New Diameter (<i>confidential</i>)		[REDACTED]		
Original SMYS (<i>confidential</i>)		[REDACTED]		
New SMYS (<i>confidential</i>)		[REDACTED]		
Project Name		Line 8119 Replacement Section 2		
Project Type		Replacement (formerly Line 1215 and Line 1216)		
Length		0.429 miles		
Location		Carpinteria		
Class		3		
MAOP (<i>confidential</i>)		[REDACTED]		
Pipe Vintage		1950		
Construction Start		07/13/2015		
Construction Finish		11/03/2015		
Original Pipe Diameter (<i>confidential</i>)		[REDACTED]		
New Diameter (<i>confidential</i>)		[REDACTED]		
Original SMYS (Line 1215 & Line 1216) (<i>confidential</i>)		[REDACTED]		
New SMYS (Line 8119) (<i>confidential</i>)		[REDACTED]		
Project Costs (\$)		Capital	O&M	Total
Loaded Project Costs		6,898,820	7,120,957	14,019,777
Disallowed Costs		-	-	-

Pipeline Safety Enhancement Plan Final Report
 Line 1004 – Hydrotest and Replacement Project

B. Maps and Images

Figure 1: Satellite Image of Line 1004 Section 1 Hydrotest Project

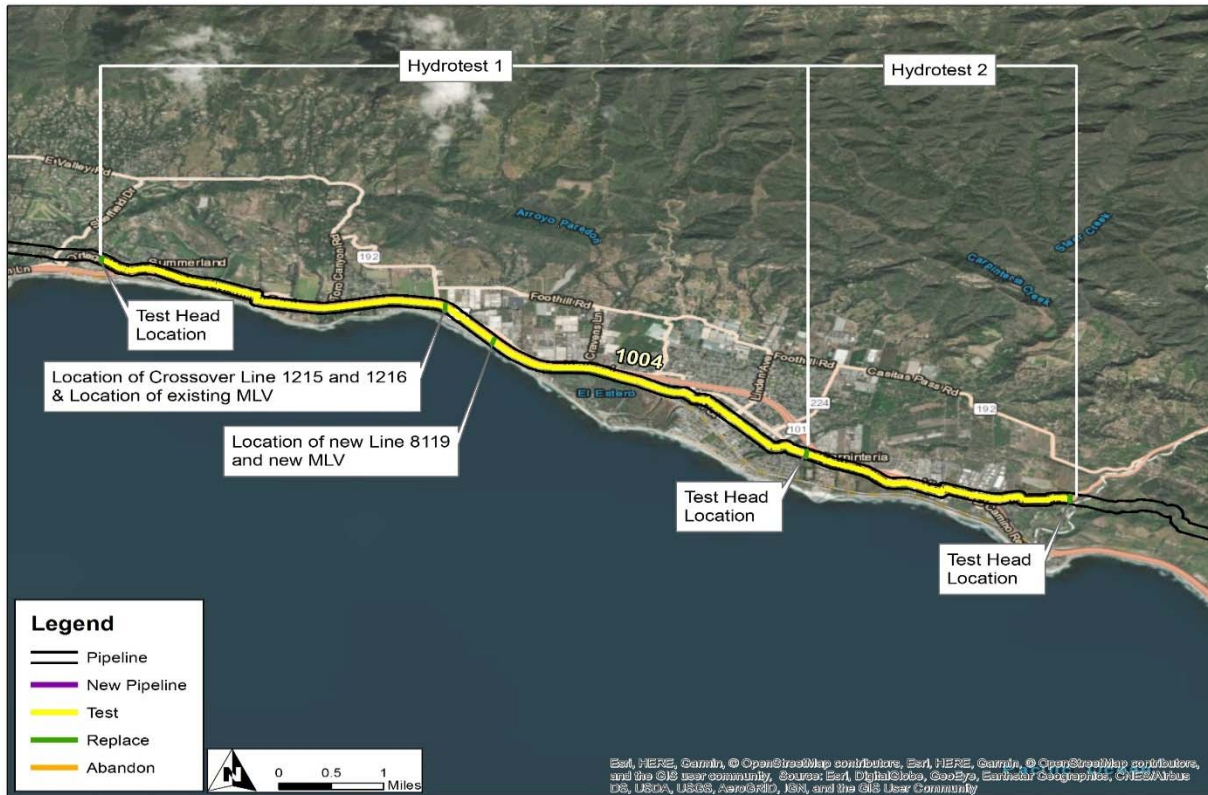

Pipeline Safety Enhancement Plan Final Report Line 1004 – Hydrotest and Replacement Project

Figure 2: Map of Line 1004 Section 1 Hydrotest Project

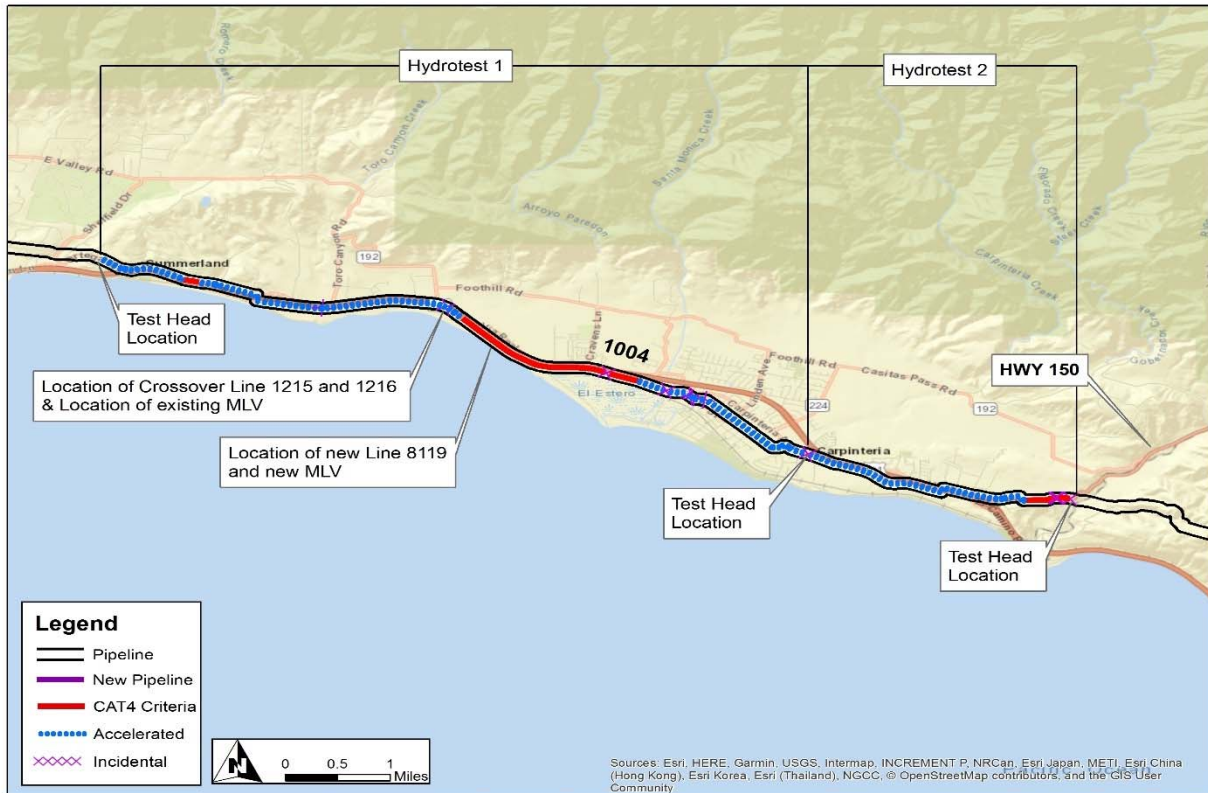

Pipeline Safety Enhancement Plan Final Report Line 1004 – Hydrotest and Replacement Project

Figure 3: Satellite Image of Crossover Line 1215 and Line 1216 Abandonment Project

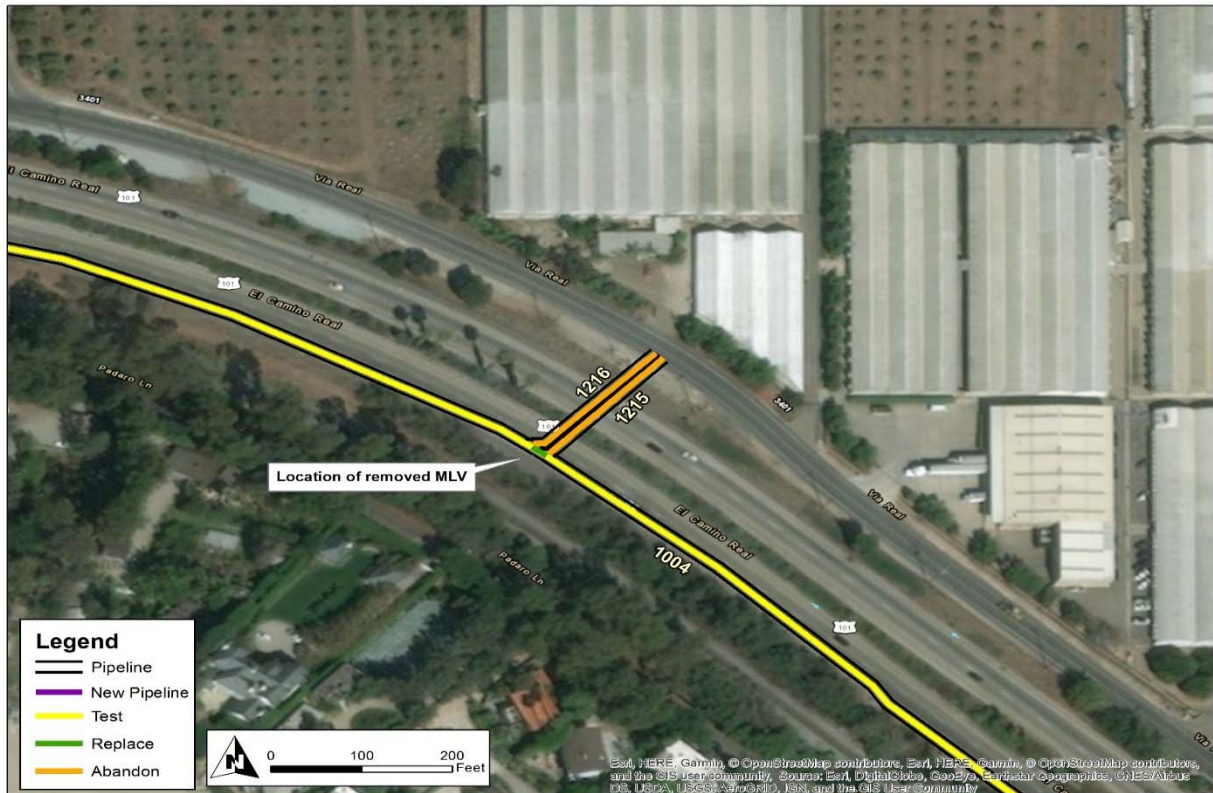

Pipeline Safety Enhancement Plan Final Report Line 1004 – Hydrotest and Replacement Project

Figure 4: Map of Crossover Line 1215 and Line 1216 Abandonment Project



Pipeline Safety Enhancement Plan Final Report
Line 1004 – Hydrotest and Replacement Project

Figure 5: Satellite Image of Line 8119 Replacement Project



Pipeline Safety Enhancement Plan Final Report
Line 1004 – Hydrotest and Replacement Project

Figure 6: Map of Line 8119 Replacement Project

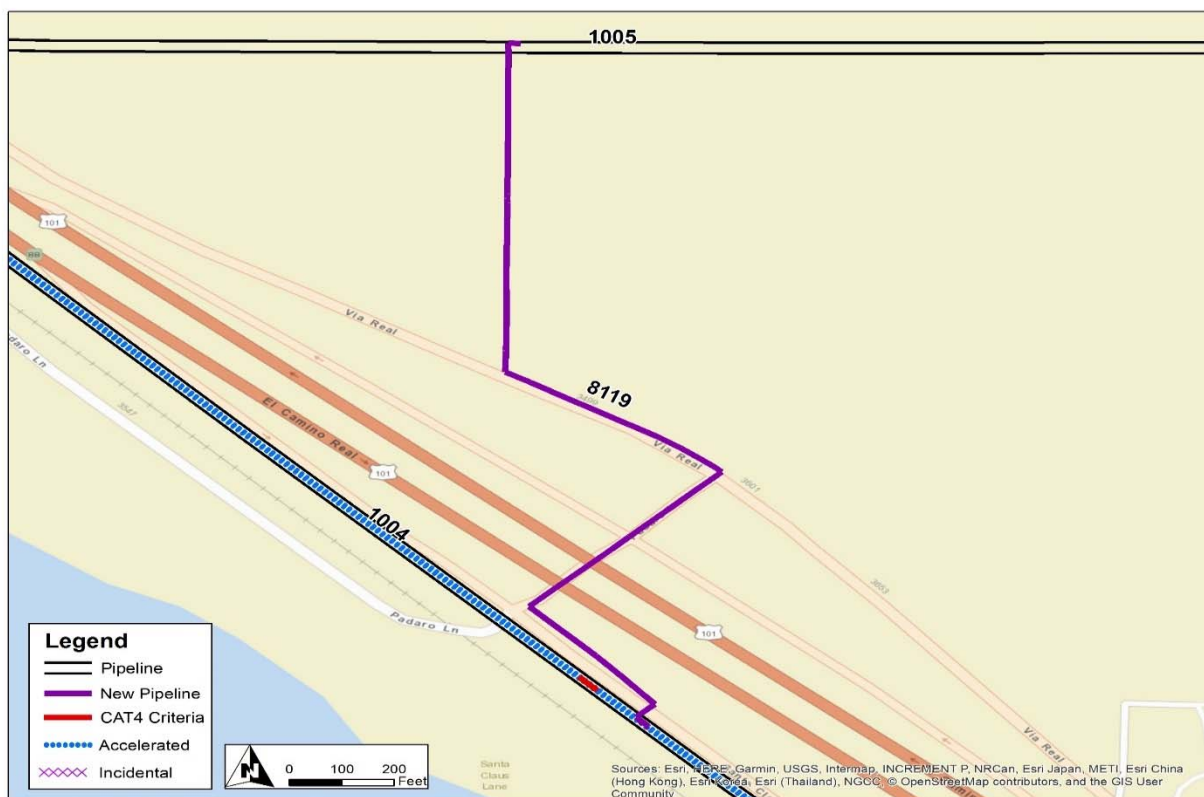

Pipeline Safety Enhancement Plan Final Report
Line 1004 – Hydrotest and Replacement Project

Figure 7: Underpass Site of New Crossover Line 8119



II. ENGINEERING, DESIGN, AND PLANNING

A. Project Scope

Table 2: Mileage Information

	Criteria	Accelerated ²	Incidental	New	Total ³
Section 1 - Hydrotest	2.034 mi.	6.4 2543 mi.	0.1 3820 mi.	0.005 mi.	8.602 mi.
	10,737 ft.	33,9234,018 ft.	730635 ft.	31 ft.	45,421 ft.
Section 2 - Replacement	0 mi.	0.060 mi.	0.002 mi.	0.366 mi.	0.429 mi.
	0 ft.	319 ft.	12 ft.	1,933 ft.	2,264 ft.
Total Final Mileage	2.034 mi.	6.485503 mi.	0.14122 mi.	0.372 mi.	9.031 mi.
	10,737 ft.	34,242337 ft.	743647 ft.	1,964 ft.	47,685 ft.

SoCalGas and SDG&E presented a conceptual project scope in workpapers supporting the 2011 PSEP filing.⁴ Prior to initiating execution of the Project in 2015, SoCalGas and SDG&E reviewed existing pipeline records to validate the scope of the Project. During the Engineering, Design and Planning phase, SoCalGas and SDG&E further refined the scope. This progression of the project scope is summarized as follows:

1. 2011 PSEP Filing: SoCalGas and SDG&E identified Line 1004 as a Phase 1A Hydrotest Project comprised of 12.718 miles of Category 4 Criteria pipe and 6.983 miles of Accelerated pipe.

² Accelerated mileage includes Phase 2A and Phase 2B pipe. Phase 2 includes pipelines without sufficient record of a pressure test in less populated areas (Phase 2A) or pipelines with record of a pressure test, but without record of a pressure test to modern – Subpart J – standards (Phase 2B). The Accelerated mileage was included to realize efficiencies and to enhance project constructability.

³ Values may not add to total due to rounding.

⁴ See Amended PSEP of SoCalGas and SDG&E, submitted December 2, 2011, in R.11-02-019 and subsequently transferred to A.11-11-002.

Pipeline Safety Enhancement Plan Final Report
Line 1004 – Hydrotest and Replacement Project

2. Scope Validation:

- a. Through scope validation activities, after the 2011 filing and before initiating execution of the Project, SoCalGas and SDG&E successfully reduced the scope of the Project by 11.986 miles of Category 4 Criteria pipe, and identified an additional 0.821 miles of Accelerated pipe, and 0.123 miles of Incidental pipe.
- b. Through review of the pipeline information, SoCalGas and SDG&E determined the two crossover lines, Line 1215 and Line 1216, were Category 4 Criteria. These two crossover lines connect Line 1004 and Line 1005. SoCalGas and SDG&E expanded the scope of the Section 1 project to include completion of the abandonment of the crossover lines.
- c. Scope validation further identified changes to class locations that attributed to changes in Category 4 Criteria pipe, extending Class 3 across Highway 150.

3. Engineering, Design and Constructability:

- a. In conjunction with reviewing the feasibility of the design, the Project Team completed a pre-design site walk with the construction team and determined a test break could be eliminated to reduce the number of hydrotests on Section 1 from three to two.
- b. SoCalGas and SDG&E also extended the project scope by approximately 600 feet downstream to a MLV location, to address Phase 1A criteria mileage (noted above).

Pipeline Safety Enhancement Plan Final Report
Line 1004 – Hydrotest and Replacement Project

4. Final Project Scope: The final project scope consists of a 8.603 mile hydrotest, relocation of a MLV, abandonment of crossover Line 1215 and Line 1216, and installation of a new 0.366 mile crossover line, Line 8119. The Accelerated mileage consists of 318 feet of Phase 2A pipe and 6.4~~2543~~ miles of Phase 2B pipe. Additionally, there was ~~743647~~ feet of Incidental pipe.

Pipeline Safety Enhancement Plan Final Report Line 1004 – Hydrotest and Replacement Project

Figure 8: Line 1005 to Line 1004 Crossover Diagram (Not to Scale)

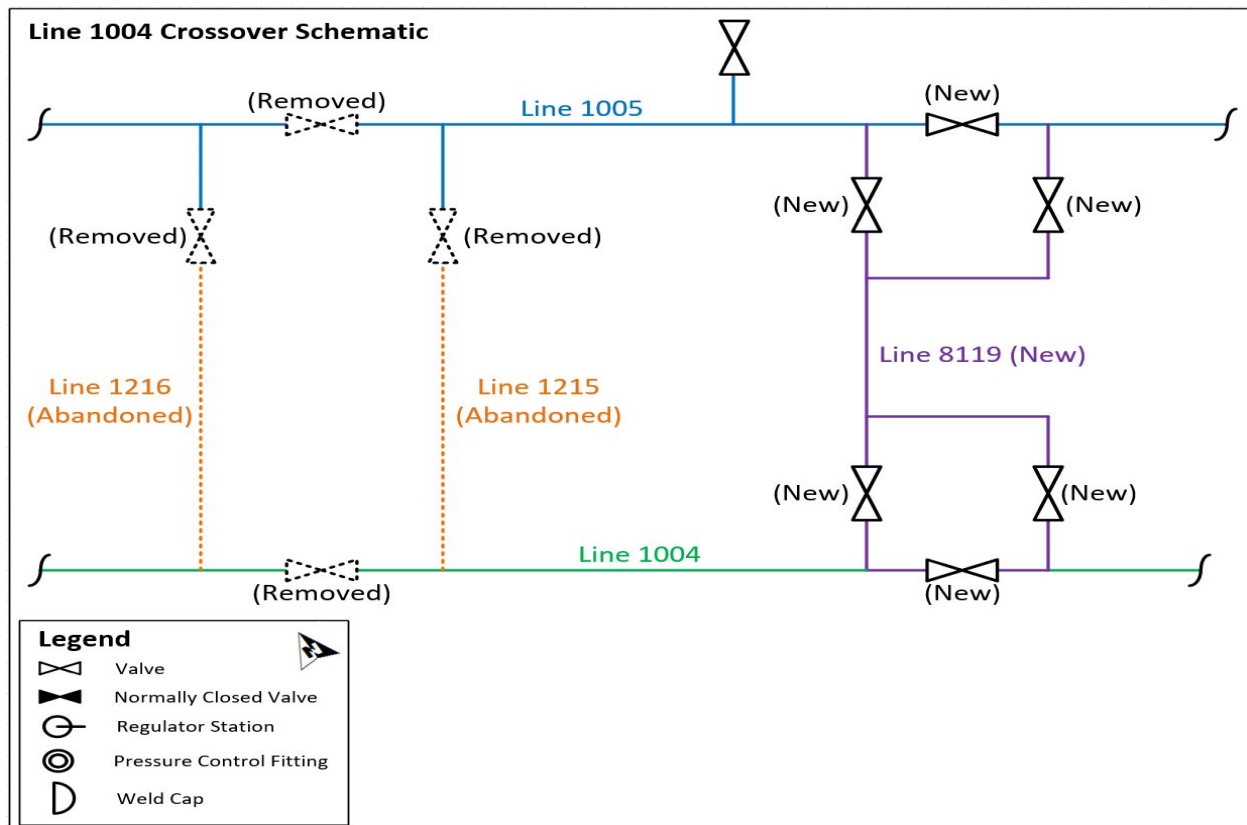

B. Decision Tree Analysis

Section 1

SoCalGas and SDG&E performed a PSEP Decision Tree analysis of Line 1004 Section 1 and confirmed the project design should commence as a Hydrotest Project.

For pipeline segments longer than 1,000 feet in length, under the approved PSEP Decision Tree, SoCalGas and SDG&E complete a preliminary review to determine whether SoCalGas and SDG&E can manage customer service impacts if the pipeline segment is taken out of service for a period of two to six weeks to complete pressure testing. Where mitigation of customer impacts to remove the line from service for pressure testing is feasible, SoCalGas and SDG&E compare the costs, constructability, risks, and benefits of pressure testing and replacement to determine whether pressure testing or replacement is the more prudent option.

Through this Decision Tree analysis, SoCalGas and SDG&E identified pressure testing as the more prudent option. Key considerations that support SoCalGas and SDG&E's determination to pressure test this segment include:

1. Shut-In Analysis: The Project Team completed a Request for Engineering Review (RER) analysis and concluded that the line could be shut in, as long as an adjacent line maintained a specified pressure.
2. Customer Impacts: In an effort to minimize impacts to a large non-core commercial offshore drilling operation that requires gas during off shore drilling activities, work was coordinated such that the line would be taken out of service outside of drilling operations.

Pipeline Safety Enhancement Plan Final Report Line 1004 – Hydrotest and Replacement Project

3. Piggability: Piggable.
4. Pipe Vintage: 1945.
5. Longseam Type: Electric Fusion Weld.
6. Longseam Repair History: No identified issues.
7. Condition of Coating: No identified issues.
8. History of Leaks: No identified issues.

Section 2

SoCalGas and SDG&E performed a PSEP Decision Tree analysis of crossover Line 1215 and Line 1216 and confirmed the project design should commence as a Replacement Project.

Segments of less than 1,000 feet are identified for replacement under the approved PSEP Decision Tree because, for short segments of pipe, the logistical costs associated with pressure testing (for example, permitting, construction, water handling, and service disruptions for a non-looped system) can approach or exceed the cost of replacement. In such circumstances, replacement affords a more cost-effective approach to achieving compliance with D.11-06-017 while providing equal safety enhancement benefits. Moreover, installation of the new segment can usually be performed while the existing service is maintained to customers, thereby avoiding service disruptions that may otherwise occur during pressure testing.

Pipeline Safety Enhancement Plan Final Report
Line 1004 – Hydrotest and Replacement Project

For this particular project, neither Replacement, nor Hydrotest were feasible alternatives at this location. Crossover Line 1215 and Line 1216 run under Highway 101 in a location where horizontal directional drilling (HDD) is not feasible, due to space restrictions, and the rugged and steep terrain that adjoins the highway cannot accommodate test heads for a pressure test. In addition, the mainline and crossover valves were located in the Caltrans Right of Way (ROW) in the shoulder of the highway and the Project Team could not safely operate them without traffic control on Highway 101. Through this analysis, SoCalGas and SDG&E determined abandonment of the existing two crossover lines and construction of a new single crossover line to the east as the more prudent option. Key considerations that support SoCalGas and SDG&E's determination to abandon and install a new crossover for this segment include:

1. Shut-In Analysis: The Project Team completed a Request for Engineering Review (RER) analysis and concluded that there were no system impacts.
2. Piggable: Non-piggable.
3. Existing Pipe Attributes: Crossover Line 1215 and Line 1216 ran under Highway 101 in a high-traffic location.
4. Longseam Type: Unknown.
5. Longseam Repair History: No identified issues.
6. Condition of Coating: Unknown.
7. History of Leaks: No identified issues.

Pipeline Safety Enhancement Plan Final Report Line 1004 – Hydrotest and Replacement Project

8. Constructability:

- a. The mainline and crossover valves were located in a Caltrans ROW along the shoulder of the highway and the Project Team could not safely operate them without implementing significant traffic control measures on Highway 101.
- b. Replacement within the existing ROW would have required the use of HDD under Highway 101, that is not possible due to space constraints.

9. Safety Enhancement: Replacement of the existing crossover lines and associated valves with a new crossover line located away from the freeway shoulder to a location with more space allowed sufficient room for safely operating the equipment and for future maintenance.

C. Engineering, Design, and Planning Factors

SoCalGas and SDG&E reviewed pipeline drawings and other information, contacted internal planning groups, communicated with external stakeholders, conducted survey activities, including reviewing public records and potholing of the area to confirm the presence of underground utilities and substructures, and completed a pre-design site walk. Key factors that influenced the engineering and design of the Project are as follows:

Section 1

1. Shut-In Analysis: The Project Team completed a Request for Engineering Review (RER) analysis and concluded the line can be shut-in as long as Line 1005, Line 1003, and/or Line 127 remain operational. Due to capacity constraints, Line 1004 and Line 1005 cannot be shut-in concurrently; one line needs to remain operational while the other is out of service.

Pipeline Safety Enhancement Plan Final Report
Line 1004 – Hydrotest and Replacement Project**2. Scheduling:**

- a. Following an annual class location review in 2014, SoCalGas and SDG&E changed the class location for a segment of pipe on this line thus requiring pressure testing or a reduction in pressure by June 15, 2015.⁵ A hydrotest of this pipeline would serve the dual purpose of meeting PSEP requirements and compliance with class location change regulations. By coordinating schedules, SoCalGas avoided two shutdowns on the same line within a few months' time, as well as additional costs that would have been required for acquiring permits and land rights twice.
 - b. SoCalGas and SDG&E coordinated construction schedules for multiple construction projects (PSEP and non-PSEP) scheduled in the same vicinity to reduce system impacts and impacts on company resources.
 - c. The schedule called for the two tests to be conducted consecutively, with a physical break in between. While the Project Team acquired the necessary Temporary Right of Entry (TRE) in a timely fashion for the first section of the hydrotest, the Project Team encountered difficulties and delays in obtaining a TRE at the preferred location for the second test.
3. **Customer Impact:** A large non-core commercial offshore drilling operation served by this line required continuous gas service while drilling. SoCalGas and SDG&E coordinated PSEP work with the customer's scheduled non-drilling periods to avoid incurring costs to provide supplemental service.

⁵ Per CFR 192.611, the MAOP of a line must be confirmed or revised (lowered) within 24 months of a change in class location.

Pipeline Safety Enhancement Plan Final Report
Line 1004 – Hydrotest and Replacement Project4. Constructability:

- a. The Project Team planned the hydrotest in two sections to mitigate the risks associated with a possible hydrotest failure within close vicinity to the Pacific Ocean and Highway 101.
- b. As part of its Pipeline Integrity program, SoCalGas and SDG&E concurrently installed a valve and pig receiver approximately 600 feet downstream of the original endpoint of the hydrotest.
- c. The Project Team redesigned the second test section to include 600 feet of Category 4 Criteria mileage on the other side of the MLV. The extension of the test to the pig receiver addressed Phase 1B Accelerated mileage and incorporated the short segment replacement section into the hydrotest, that achieved the objectives of enhancing public safety, minimizing impacts to the surrounding landowners/community and maximizing the cost effectiveness of SoCalGas and SDG&E safety investments.
- d. Relocation of the new MLV further away from Highway 101 facilitated constructability and enhanced public and employee safety by improving accessibility for future operation and maintenance activities.

5. Site Conditions: The pipeline runs adjacent to a highway and the Pacific coastline with limited workspaces. To maximize space and planning efficiencies, SoCalGas and SDG&E planned construction activities so as to synchronize projects and share the same workspaces.

6. Groundwater: Due to the presence of shallow groundwater, the Project Team planned for measures to address open bellholes.

Pipeline Safety Enhancement Plan Final Report Line 1004 – Hydrotest and Replacement Project

Section 2

1. Constructability: In order to cross Highway 101 in a similar manner as crossover Line 1215 and Line 1216, construction of a new crossover line would have required horizontal direction drilling, that was not feasible at this location due to space limitations on both ends.
2. Reroute: The Project Team assessed two routes for relocating the crossover line:
 - a. The Project Team selected the Padaro Lane underpass as the preferred alternative for the new line alignment. The benefits of this location include:
 - i. Preserving the existing MLV spacing on Line 1004 and Line 1005,
 - ii. Providing suitable space to automate Line 1004 and Line 1005 valves,
 - iii. Minimizing the length of the new crossover; and
 - iv. Providing safer and more direct access to the pipeline for operations and maintenance activity.
 - b. The Project Team evaluated the Santa Ynez Avenue overpass and determined the obstacles, risks and additional costs presented at this location include:
 - i. Requiring HDD underneath Highway 101; and
 - ii. The MLV is located in front of an elementary school.

D. Scope Changes

Through engineering, design, and planning activities, SoCalGas and SDG&E determined that changes in scope were appropriate to enhance the design of the Project and address engineering factors. As a result, the preliminary cost estimate does not fully reflect the final scope. Summarized below are notable changes in scope made after the preliminary cost estimate was developed and approved.

Section 1

1. Land Access Rights: The site identified for the placement of a test head was on private property, however the land owner was not amenable to having construction work on their property. Through initial scoping analysis, SoCalGas and SDG&E identified a section on this property upstream of a MLV that met the criteria for a future phase replacement. Due to unsuccessful negotiations with the land owner for the rights to construction on their property, the Project Team decided to extend the hydrotest to minimize the impacts to this landowner.
2. Land Use: By consolidating the originally planned three hydrotests into two hydrotests, the Project Team eliminated the need for an additional staging area, achieving the PSEP objectives to minimize community impacts and maximize efficiencies.

Section 2

1. Permit Conditions: Caltrans required the pipeline depth to be eight feet, rather than the typical three feet, that resulted in design changes that drove increases in engineering and construction related costs.

III. CONSTRUCTION

A. Construction Contractor Selection

The Project Team prepared an initial cost estimate based on the preliminary design. Following completion of the engineering, design and planning activities described above, the Project Team directed the Performance Partner to prepare cost estimates based on a more detailed engineering design package, which included the updated design described in the discussion of notable Scope Changes above. SoCalGas and SDG&E awarded the construction contract to the Performance Partner.

1. SoCalGas and SDG&E’s Preliminary Construction Cost Estimate (*confidential*):
SoCalGas and SDG&E’s preliminary cost estimate for construction was [REDACTED].
2. Construction Contractor’s Target Price Estimate (*confidential*): The Construction Contractor’s cost estimate was [REDACTED], which was [REDACTED] than SoCalGas and SDG&E’s preliminary cost estimate for construction.

B. Construction Schedule

Table 3: Construction Timeline

Section 1	
Construction Start	05/11/2015
Construction Completion	11/15/2015
NOP Date	08/13/2015
Section 2	
Construction Start	07/13/2015
Construction Completion	11/03/2015
NOP Date	09/22/2015

C. Changes During Construction

The conditions summarized below were encountered during construction. Activities to address or mitigate these conditions resulted in approximately \$550,000 in change orders.

Section 1

1. Substructures:

- a. The construction crew encountered an unmapped communication line that exceeded minimum separation requirements where the new bridle valve assembly was planned for installation. SoCalGas and SDG&E approved field design changes to avoid relocating the communication line.
- b. Construction crews encountered a shorter pup at the tie-in location than anticipated, that prevented the line from being tied in as planned. The Project Team installed the shorter-than-anticipated pup on an elbow. The plan was to tie-in to the pup, but because the length of the pup was too short, it was not possible to cut out the existing girth weld and leave a long enough pup on the elbow. To address this condition, the Project Team extended the tie-in piece to replace the elbow as well. This unanticipated condition required construction crews to perform additional excavation activities.

2. Land Rights/Acquisition: Negotiations for the TRE took longer than anticipated which resulted in a one month delay between hydrotests.

Pipeline Safety Enhancement Plan Final Report Line 1004 – Hydrotest and Replacement Project

Section 2

1. Site Conditions: During excavation, construction crews encountered ground water. To address this unanticipated condition and enhance employee safety, SoCalGas and SDG&E authorized construction crews to excavate larger trenches and construct additional shoring.
2. Substructures: During planning and design, the survey team marked a fiber optic line that ran parallel to the new line that was to be installed crossing the street. Once excavation activities began, an additional, unmarked utility was uncovered. To maintain minimum separation requirements between the unmarked fiber optic utility line and the gas pipeline, SoCalGas and SDG&E installed the pipeline with a longer vertical offset which was required to maintain minimum separation requirements between both utilities. That portion of the line was required to be deeper and longer than originally anticipated.

Pipeline Safety Enhancement Plan Final Report
Line 1004 – Hydrotest and Replacement Project

Figure 9: Groundwater Encountered During Excavation



Pipeline Safety Enhancement Plan Final Report
Line 1004 – Hydrotest and Replacement Project

Figure 10: Groundwater Mitigation



Pipeline Safety Enhancement Plan Final Report
Line 1004 – Hydrotest and Replacement Project

D. Commissioning and Site Restoration

Commissioning activities include restoration of the site, final inspection and placement of the pipeline back into service, transportation and disposal of hydrotested water and hazardous material, and site demobilization.

The Project Team identified contaminated soil at one of the laydown yards. Negotiations with the property owner and city delayed final remediation of the laydown yard by 40 days. The city required removal of the crushed rock foundation and extensive environmental sampling at the laydown yard after the Project was demobilized, adding unanticipated costs to the Project.

Closeout activities include development of final drawings, finalization of a reconciliation package, and updates to company recordkeeping systems to reflect the completed scope of work.

IV. PROJECT COSTS

A. Cost Avoidance Actions

SoCalGas and SDG&E exercised due diligence in the planning, design, and construction activities for this project to minimize or avoid costs when prudent to do so. As discussed above, the Project Team conducted a site visit to identify and incorporate discernible site conditions into the engineering, design, and planning of the Project.

Specific examples of cost avoidance actions taken on this project are:

1. Engineering and Design: The Project Team extended the project scope approximately 600 feet downstream to utilize a new MLV and pig receiver installed by Pipeline Integrity. It reduced the number of test sections required in future PSEP Phases, minimizing customer and community impacts, and avoided the costs associated with replacement of a third section of pipe.
2. Planning and Coordination:
 - a. SoCalGas and SDG&E planned the Project to coordinate with another project so as to share the main staging area. This achieved avoidance of additional mobilization/demobilization costs, as well as costs to set up and restore the [second area](#).
 - b. By coordinating the abandonment of existing crossover Line 1215 and Line 1216 (Section 1) with the shutdowns of Line 1005⁶ and Line 1004 (Section 1), the Project Team further minimized customer impacts by avoiding a third shutdown.

⁶ Line 1005 Hydrotest was submitted for cost recovery in workpaper in A.16-09-007.

Pipeline Safety Enhancement Plan Final Report
Line 1004 – Hydrotest and Replacement Project

- c. During the one month delay between the completion of the first hydrotest and the initiation of the second hydrotest, SoCalGas and SDG&E mobilized the construction crew to begin construction on Line 8119, which maximized efficiencies by avoiding standby charges.

B. Cost Estimate

Based on the preliminary design, once the project scope was confirmed and engineering, design and planning activities were underway, SoCalGas and SDG&E prepared an estimate of the Direct Costs of the Project in the amount of \$9,639,454. This estimate was prepared in May of 2014, using the “SCG Pipeline Estimate Template Rev 0” estimating tool, the most current version of the PSEP Estimate Template at the time. The Project Team considered the conditions known at the time to prepare the preliminary Direct Cost estimate. This estimate reflects the projected Labor, Material, and Services costs anticipated to be incurred to execute the Project.

SoCalGas and SDG&E estimated Indirect Costs of the Project based on the estimated Direct Costs and other project related variables.

C. Actual Direct and Indirect Costs

Actual Direct Costs reflect the Labor, Material, and Service costs incurred to execute the Project. Actual Indirect Costs reflect costs for incremental overhead loaders in accordance with Company overhead allocation policies. The total loaded cost of the Project is \$14,019,777.

Pipeline Safety Enhancement Plan Final Report
Line 1004 – Hydrotest and Replacement Project

Table 4: Estimated and Actual Direct Costs and Variances

Direct Costs (\$)	Estimate	Actuals	Delta Over/(Under)
Company Labor	1,180,175	390,073	(790,102)
Materials	572,344	323,092	(249,252)
Construction Contractor	4,716,122	5,428,004	711,882
Construction Management & Support	217,709	1,787,446	1,569,737
Environmental	284,350	863,160	578,810
Engineering & Design	994,120	2,275,176	1,281,056
Project Management & Services	397,330	401,871	4,541
ROW & Permits	258,500	89,220	(169,280)
GMA	1,018,804	1,490,470	471,666
Total Direct Costs	9,639,454	13,048,512	3,409,058

Table 5: Estimated and Actual Indirect Costs, Total Costs, and Variances

Indirect Costs / Total Costs (\$)	Estimate	Actuals	Delta Over/(Under)
Overheads	1,851,639	874,763	(976,876)
AFUDC	-	83,298	83,298
Property Taxes	-	13,204	13,204
Total Indirect Costs	1,851,639	971,265	(880,374)
Total Direct Costs	9,639,454	13,048,512	3,409,058
Total Loaded Costs	11,491,093	14,019,777	2,528,684

Pipeline Safety Enhancement Plan Final Report
Line 1004 – Hydrotest and Replacement Project

D. Disallowance

There was no disallowance for Line 1004 as there were no post-1955 segments included in the project without records that provide the minimum information to demonstrate compliance with then applicable industry standards or regulatory strength testing and recordkeeping requirements then applicable.

V. CONCLUSION

SoCalGas and SDG&E enhanced the safety of their integrated natural gas transmission system by prudently executing the Line 1004 Hydrotest and Replacement Project.

Through this Hydrotest and Replacement Project, SoCalGas and SDG&E successfully hydrotested 8.603 miles of high pressure transmission pipe, completed the abandonment of two crossover lines, and replaced the two abandoned crossover lines with a single 0.366 mile crossover line in the city of Carpentaria. The total loaded cost of the Project is \$14,019,777.

SoCalGas and SDG&E executed this project prudently through planning and design: executing the Project in two rather than three hydrotests; eliminating a Phase 1B short replacement project by extending the test heads and including it in the hydrotest; moving a MLV to a safer more accessible alignment away from a highway off ramp; and replacing two crossover lines with one so as to complete the safety enhancement work as soon as practicable.

SoCalGas and SDG&E engaged in prudent cost avoidance efforts by reducing project scope through validation; designing and planning the Project to eliminate a third hydrotest; and avoiding standby charges by redeploying the construction crew to work on the replacement scope of work during an unanticipated lull between the two hydrotests. SoCalGas and SDG&E reduced future maintenance costs by locating a MLV and the crossover line to safer and more accessible locations.

Pipeline Safety Enhancement Plan Final Report
Supply Line 36-9-09 JJ Abandonment Project

I. SUPPLY LINE 36-9-09 JJ ABANDONMENT PROJECT

A. Background and Summary

Supply Line 36-9-09 JJ is a predominantly [REDACTED] diameter transmission pipeline that runs approximately 0.5 miles along Atascadero Avenue through a residential neighborhood from Atascadero Avenue and Ardilla Avenue to Atascadero Avenue and Morrow Road in the City of Atascadero. The pipeline is primarily routed across a Class 3 location. This report describes the activities associated with the Supply Line 36-9-09 JJ Abandonment Project that consists of the abandonment of 0.462 miles of pipeline. The specific attributes of this Project are detailed in Table 1 below. The total loaded cost of the Project is \$1,906,792.

The Supply Line 36-9-09 JJ Abandonment Project is a component of Supply Line 36-9-09-North, that was identified in the 2011 PSEP filing¹ as a 16.016-mile replacement project. The pipeline is located in the cities of Atascadero, San Luis Obispo, Pismo Beach, and Arroyo Grande and is primarily routed across a Class 3 location. For project manageability purposes and due to unique characteristics related to non-contiguous portions of the pipeline, SoCalGas and SDG&E divided Supply Line-36-9-09 North into several project sections to be managed individually (see Figure 1). Two key reasons drove the decision to manage the work on Supply Line 36-9-09 North in this manner; the sections were in different locations, and they were physically separated from each other by non-PSEP segments of pipeline. Additionally, project scopes (hydrotesting, replacement or abandonment) differed among the sections that led to differing permit acquisition timelines.

¹ See Amended PSEP of SoCalGas and SDG&E, submitted December 2, 2011, in R.11-02-019 and subsequently transferred to A.11-11-002.

Pipeline Safety Enhancement Plan Final Report
Supply Line 36-9-09 JJ Abandonment Project

Table 1: General Project Information

Project Name	Supply Line 36-9-09 JJ		
Project Type	Abandonment		
Length	0.462 miles		
Location	Atascadero		
Class	3		
MAOP (<i>confidential</i>)	[REDACTED]		
Pipe Vintage	1920		
Construction Start	06/22/2016		
Construction Finish	08/22/2016		
Original Pipe Diameter (<i>confidential</i>)	[REDACTED]		
New Diameter (<i>confidential</i>)	N/A		
Original SMYS ² (<i>confidential</i>)	[REDACTED]		
New SMYS (<i>confidential</i>)	N/A		
Project Costs (\$)	Capital	O&M	Total
Loaded Project Costs	1,904,606	2,186	1,906,792
Disallowed Costs	-	-	-

² Highest percentage of Specified Minimum Yield Strength (SMYS) of Category 4 Criteria pipe.

Pipeline Safety Enhancement Plan Final Report
Supply Line 36-9-09 JJ Abandonment Project

B. Maps and Images

Figure 1: Map of Supply Line 36-9-09 North PSEP Projects



Pipeline Safety Enhancement Plan Final Report
Supply Line 36-9-09 JJ Abandonment Project

Figure 3: Overview Map of Supply Line 36-9-09 JJ Abandonment Project

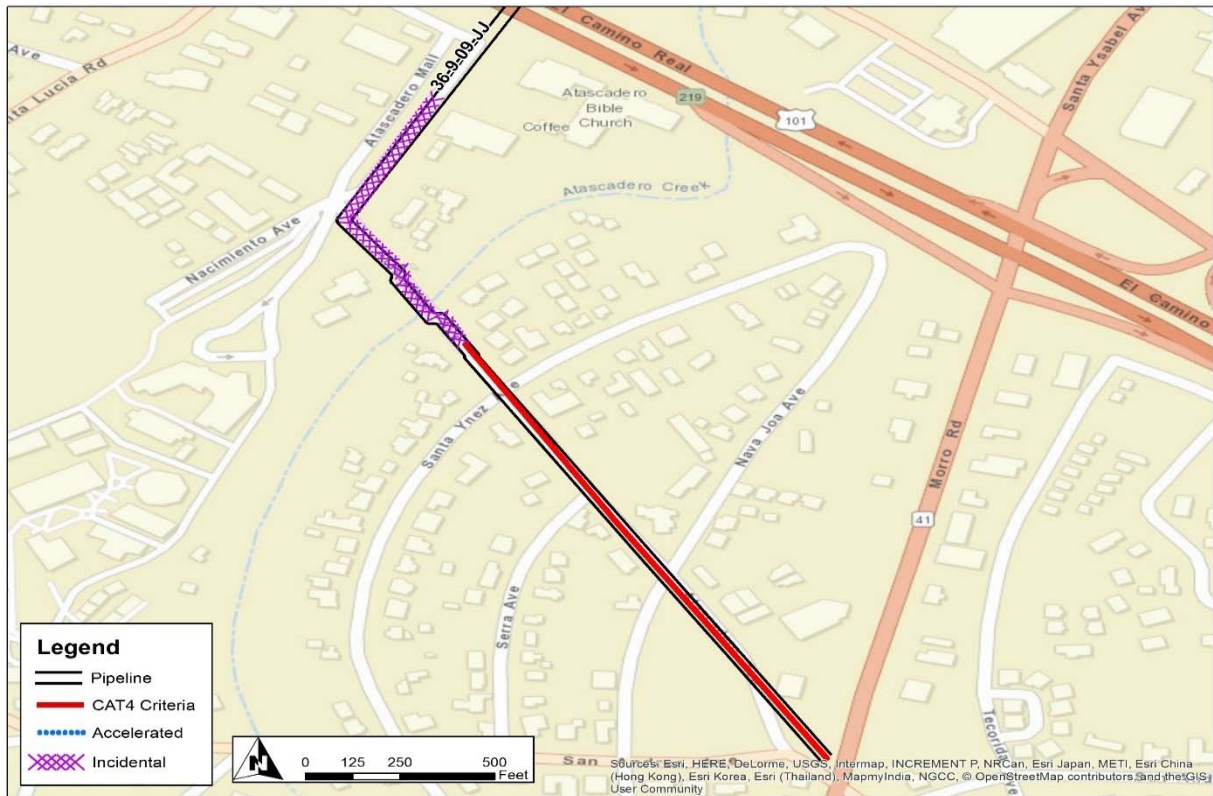

Pipeline Safety Enhancement Plan Final Report
 Supply Line 36-9-09 JJ Abandonment Project

Figure 4: Schematic of Supply Line 36-9-09 JJ Abandonment Project

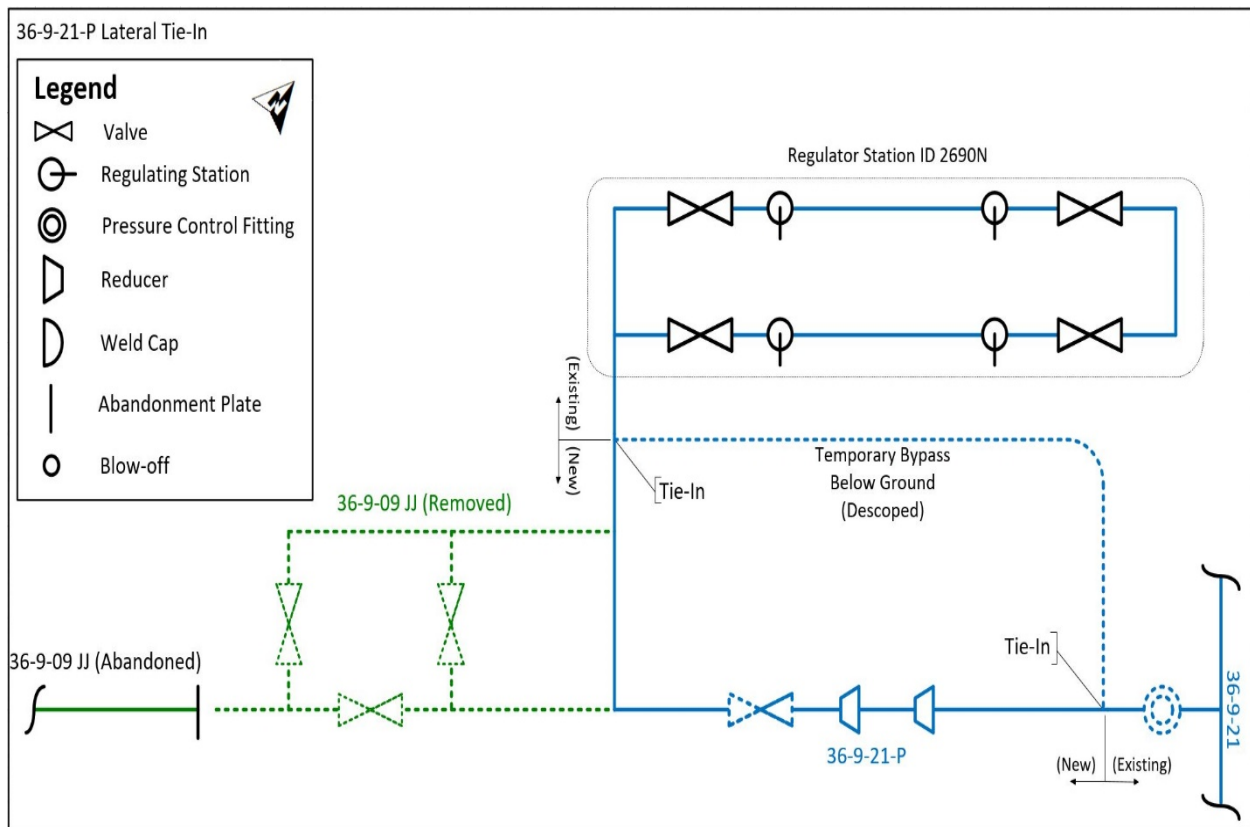

Pipeline Safety Enhancement Plan Final Report
Supply Line 36-9-09 JJ Abandonment Project
and
Supply Line 36-9-09 North Section 1 Replacement Project

Figure 5: Satellite Image of Supply Line 36-9-09 JJ Abandonment Project and Supply Line 36-9-09 North Section 1 Replacement Project

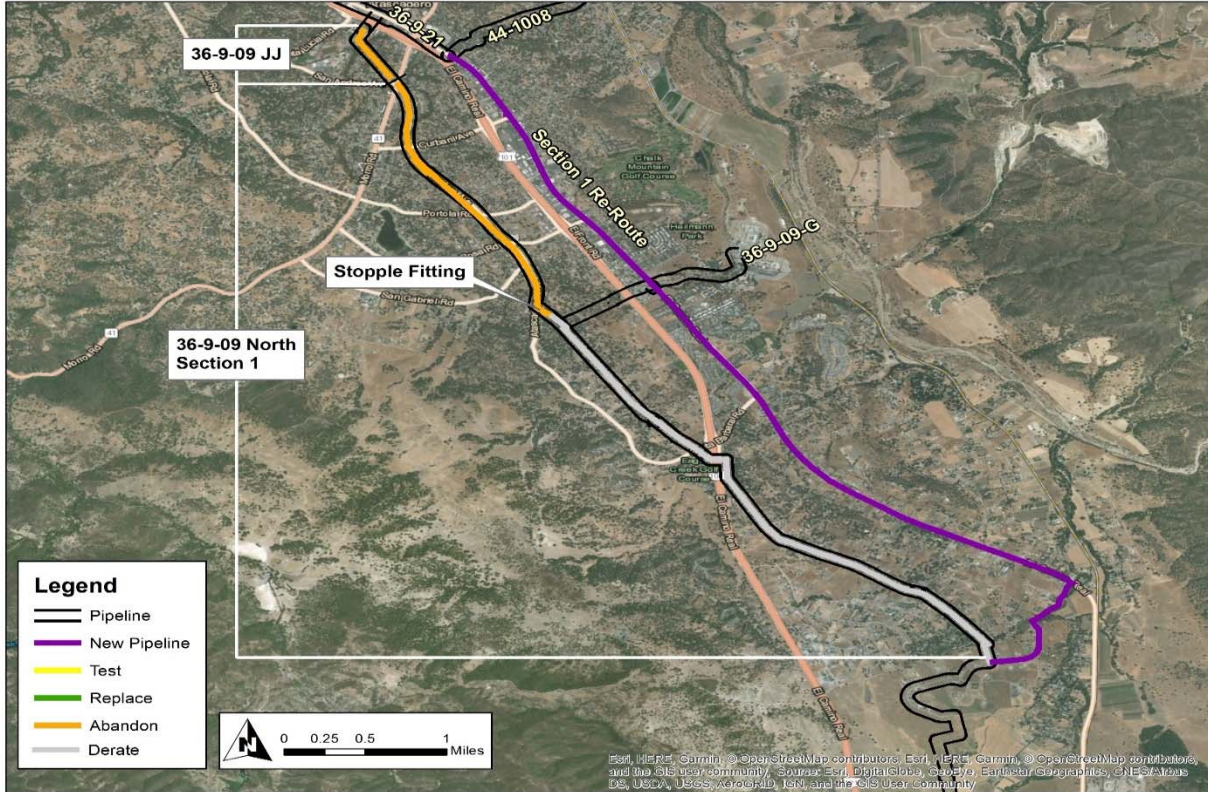

Pipeline Safety Enhancement Plan Final Report
Supply Line 36-9-09 JJ Abandonment Project

II. ENGINEERING, DESIGN, AND PLANNING

A. Project Scope

Table 2: Mileage Information

	Criteria	Accelerated	Incidental	New	Total ³
Final Mileage	0.273 mi.	0 mi.	0.188 mi.	0.001 ft.	0.462 mi
	1,442 ft.	0 ft.	992 ft.	6 ft.	2,441 ft.

SoCalGas and SDG&E presented a conceptual project scope in workpapers supporting the 2011 PSEP filing. Prior to initiating execution of the Project in 2016, SoCalGas and SDG&E reviewed existing pipeline records to validate the scope of the Project. During the Engineering, Design, and Planning phase, SoCalGas and SDG&E further refined the scope. This progression of the project scope is summarized as follows:

1. 2011 PSEP Filing: SoCalGas and SDG&E identified Supply Line 36-9-09 JJ as a Phase 1B Project comprised of approximately 0.34 miles of pipe.
2. Scope Validation: Through scope validation activities, after the 2011 filing and before initiating execution of the Project, SoCalGas and SDG&E reclassified this project as a Phase 1A project made up of 0.272 miles of Category 4 Criteria pipe, increasing the scope of the Project by 0.068 miles.

³ Values may not add to total due to rounding.

Pipeline Safety Enhancement Plan Final Report
Supply Line 36-9-09 JJ Abandonment Project

3. Engineering, Design, and Constructability:
 - a. To complete the abandonment of Supply Line 36-9-09 JJ, three valves would need to be removed at the north end of the project where this line ties into a regulator station. Once the valves were removed, a tie-in piece would be installed so that the remaining Supply Line 36-9-09 JJ directly feeds the regulator station, this would be later renamed to Supply Line 36-9-21-P following construction. In order to perform the abandonment at the north end of the project, a stopple fitting would be installed north of a new isolation valve. The south end isolation would be completed using a stopple fitting at San Rafael Road and Colorado Road.
 - b. Per the Request for Engineering Review (RER) analysis, had construction occurred during fall or winter conditions, a regulator station would have had to remain in service via a temporary bypass. Since the project mobilized during summer conditions, the regulator station was shut-in during construction and the by-pass was descope.
 - c. SoCalGas and SDG&E determined this line could be abandoned and still maintain system reliability without any customer impacts.
 - d. Incidental pipe was included in order to abandon Supply Line 36-9-09 JJ to the north end regulator station.
 - e. The abandonment of this line consists of cutting the two end points, capping them and then removing the line from service.
4. Final Project Scope: The final project scope consists of a 0.462 mile Abandonment. The Incidental mileage consists of 992 feet of pipe.

Pipeline Safety Enhancement Plan Final Report
Supply Line 36-9-09 JJ Abandonment Project

B. Decision Tree Analysis

SoCalGas and SDG&E performed a PSEP Decision Tree analysis of Supply Line 36-9-09 JJ and confirmed the project design should commence as an Abandonment Project. Due to the planned replacement and reroute of the adjacent Supply Line 36-9-09 North Section 1 Project, Supply Line 36-9-09 JJ was not needed for reliability or future capacity purposes.

Through this Decision Tree analysis, SoCalGas and SDG&E identified Abandonment as the more prudent option. Key considerations that support SoCalGas and SDG&E's determination to abandon this segment include:

1. Shut-In Analysis: The Project Team completed a RER analysis and concluded that Supply Line 36-9-09-JJ can be abandoned without impacting the feed to a regulator station after completion of the Supply Line 36-9-09 North Section 1 Replacement Project. The Project Team needed to install a temporary bypass to facilitate shut-in of a regulator station outside of spring and summer conditions since the tie-in was planned for December. The temporary bypass was later descoped as the Project Team completed construction for Supply Line 36-9-09 North Section 1 in summer conditions.
2. Piggability: Non-piggable.
3. Pipe Vintage: 1920.
4. Longseam Type: Unknown.
5. Longseam Repair History: No identified issues.
6. Condition of Coating: No identified issues.
7. History of Leaks: No identified issues.

Pipeline Safety Enhancement Plan Final Report
Supply Line 36-9-09 JJ Abandonment Project

C. Engineering, Design, and Planning Factors

SoCalGas and SDG&E reviewed pipeline drawings and other information, contacted internal planning groups, communicated with external stakeholders, conducted survey activities, including reviewing public records to confirm the presence of underground utilities and substructures, and completed a pre-design site walk. Key factors that influenced the engineering and design of the Project are as follows:

1. Customer Impact: Per the RER, there are no customers within the abandonment and there was no interruption to the downstream customers, due to the installation of a stopple fitting used to facilitate the abandonment.
2. Schedule Coordination:
 - a. The Supply Line 36-9-09 JJ Abandonment Project would be completed in coordination with the Supply Line 36-9-09 North Section 1 Replacement Project as the abandonment of this supply line could not be completed until the new Supply Line 36-9-09 Section 1 project was in service. Supply Line 36-9-09 JJ also fed a regulator station at the north end and if the project was completed outside of the spring and summer conditions, a temporary by-pass would be required to feed this regulator station.
 - b. Supply Line 36-9-09 North Section 1 Replacement Project was nearby and under construction during the same time frame. The two projects shared a laydown yard.
3. Community Impact: This pipeline runs through an area with high pedestrian and vehicle traffic. The north location of the project is located near a school and it was the school's preference that SoCalGas and SDG&E complete this project during the summer to prevent interference with the school activities.

Pipeline Safety Enhancement Plan Final Report
Supply Line 36-9-09 JJ Abandonment Project

4. Permit Conditions: The City of Atascadero requested work hours of 9 AM to 3 PM.
5. Land Use: The Supply Line 36-9-09 JJ Project laydown yard was shared with the Supply Line 36-9-09 North Section 1 Project.
6. Environmental: The Project Team identified the potential for contaminated ground water and nesting birds.
7. Valves: The Project Team determined that a new isolation valve to the regulator station would need to be installed to facilitate the abandonment of Supply Line 36-9-09 JJ and tie-in to Supply Line 36-9-21.

D. Scope Changes

Through engineering, design, and planning activities, SoCalGas and SDG&E determined that changes in scope were appropriate to enhance the design of the Project and address engineering factors. As a result, the preliminary cost estimate does not fully reflect the final scope.

As described above, the engineering and design plans progressed into pre-construction the Project Team removed a temporary bypass from the project scope once it was established the construction timeframe and sequencing of the Supply Line 36-9-09 Section 1 Project would occur in summer conditions.

Pipeline Safety Enhancement Plan Final Report
Supply Line 36-9-09 JJ Abandonment Project

III. CONSTRUCTION

A. Construction Contractor Selection

The Project Team prepared an initial cost estimate based on the preliminary design. Following completion of the engineering, design, and planning activities described above, the Project Team directed the Performance Partner to prepare cost estimates based on a more detailed engineering design package, that included the updated design described in the discussion of notable Scope Changes above. SoCalGas and SDG&E awarded the construction contract to the Performance Partner.

1. SoCalGas and SDG&E’s Preliminary Construction Cost Estimate (confidential):
SoCalGas and SDG&E’s preliminary cost estimate for construction was [REDACTED]
2. Construction Contractor’s Target Price Estimate (confidential): The Construction Contractor’s cost estimate was [REDACTED], that was [REDACTED] than SoCalGas and SDG&E’s preliminary cost estimate for construction.

B. Construction Schedule

Table 3: Construction Timeline

Construction Start Date	06/22/2016
Construction Completion Date	08/22/2016
NOP Date	08/11/2016

Pipeline Safety Enhancement Plan Final Report
Supply Line 36-9-09 JJ Abandonment Project

C. Changes During Construction

The conditions summarized below were encountered during construction. Activities to address or mitigate these conditions resulted in approximately \$31,200 in change orders.

1. Gas Handling: The Project Team installed a pressure control fitting (PCF) to facilitate the abandonment and to support a planned medium pressure conversion. This installation allowed for uninterrupted customer service during a sequence of coordinated events that overlapped to facilitate the gas handling of the Supply Line 36-9-09 Section 1 Replacement Project and conversion of customers to a medium pressure system. This coordinated work effort between the district and the customer required an extension of the excavation and additional gas handling support by the contractor.
2. Schedule Delay: The reallocation of resources supporting the adjacent Supply Line 36-9-09 North Section 1 Replacement and Supply Line 36-9-09 Section 5A Replacement Projects extended the project by one month. The Project Team put construction at Supply Line 36-9-09 JJ on hold. The contractor did not incur standby charges because resources were reallocated and deployed to the Supply Line 36-9-09 North Section 1 Project.

Pipeline Safety Enhancement Plan Final Report
Supply Line 36-9-09 JJ Abandonment Project

Figure 6: Potholing Operation



Pipeline Safety Enhancement Plan Final Report
Supply Line 36-9-09 JJ Abandonment Project

Figure 7: Installation of a Bottom Out Fitting



Pipeline Safety Enhancement Plan Final Report
Supply Line 36-9-09 JJ Abandonment Project

D. Decommissioning and Site Restoration

Decommissioning activities included site restoration, final inspections, cut and weld plates on the abandoned lines, installed weld caps on the active lines, disposal of hazardous material and demobilization from the site. Closeout activities included development of final drawings, finalization of a reconciliation package and updates to company recordkeeping systems to reflect the completed scope of work.

Pipeline Safety Enhancement Plan Final Report
Supply Line 36-9-09 JJ Abandonment Project

IV. PROJECT COSTS

A. Cost Avoidance Actions

SoCalGas and SDG&E exercised due diligence in the planning, design, and construction activities for this project to minimize or avoid costs when prudent to do so. As discussed above, the Project Team conducted a site visit to identify and incorporate discernible site conditions into the engineering, design, and planning of the Project. Specific examples of cost avoidance actions taken on this project are:

1. Land Use: The laydown yard was shared with the Supply Line 36-9-09 North Section 1 Replacement Project.
2. Planning and Coordination: The Project Team avoided standby charges during the construction delay by diverting construction resources to other adjacent projects, specifically the Supply Line 36-9-09 Section 1 Replacement Project.

B. Cost Estimate

Based on the preliminary design, once the project scope was confirmed and engineering, design, and planning activities were underway, SoCalGas and SDG&E prepared an estimate of the Direct Costs of the Project in the amount of \$2,342,690. This estimate was prepared in April of 2016 using the “SCG Pipeline Estimate Template Rev 3” estimating tool, the most current version of the PSEP Estimate Template at the time. The Project Team considered the conditions known at the time to prepare the preliminary Direct Cost estimate. This estimate reflects the projected Labor, Material, and Services costs anticipated to be incurred to execute the Project.

SoCalGas and SDG&E estimated Indirect Costs of the Project based on the estimated Direct Costs and other project related variables

Pipeline Safety Enhancement Plan Final Report
Supply Line 36-9-09 JJ Abandonment Project

C. Actual Direct and Indirect Costs

Actual Direct Costs reflect the Labor, Material, and Services costs incurred to execute the Project. Actual Indirect Costs reflect costs for incremental overhead loaders in accordance with Company overhead allocation policies. The total loaded cost of the Project is \$1,906,792.

Table 4: Estimated and Actual Direct Costs and Variances

Direct Costs (\$)	Estimate	Actuals	Delta Over/(Under)
Company Labor	94,630	74,525	(20,105)
Materials	46,949	33,925	(13,024)
Construction Contractor	767,347	510,887	(256,460)
Construction Management & Support	70,400	100,189	29,789
Environmental	95,260	54,898	(40,362)
Engineering & Design	812,906	569,453	(243,453)
Project Management & Services	196,486	123,002	(73,484)
ROW & Permits	7,256	32,942	25,686
GMA	251,456	195,238	(56,218)
Total Direct Costs	2,342,690	1,695,059	(647,631)

Table 5: Estimated and Actual Indirect Costs, Total Costs, and Variances

Indirect Costs/Total Costs (\$)	Estimate	Actuals	Delta Over/(Under)
Overheads	223,802	181,038	(42,764)
AFUDC	72,897	27,047	(45,850)
Property Taxes	16,833	3,648	(13,185)
Total Indirect Costs	313,532	211,733	(101,799)
Total Direct Costs	2,342,690	1,695,059	(647,631)
Total Loaded Costs	2,656,222	1,906,792	(749,430)

Pipeline Safety Enhancement Plan Final Report
Supply Line 36-9-09 JJ Abandonment Project

D. Disallowances

The scope of the Supply Line 36-9-09 JJ Abandonment Project did not include any pipe subject to disallowance under D.14-06-007 or D.15-12-020.

Pipeline Safety Enhancement Plan Final Report
Supply Line 36-9-09 JJ Abandonment Project

V. CONCLUSION

SoCalGas and SDG&E enhanced the safety of their integrated natural gas transmission system by prudently executing the Supply Line 36-9-09 JJ Abandonment Project.

Through this Abandonment Project, SoCalGas and SDG&E successfully abandoned 0.462 miles of pipe in the City of Atascadero. The total loaded cost of the Project is \$1,906,792.

SoCalGas and SDG&E executed this project prudently through minimizing customer and community impacts and avoiding costs through sharing of construction resources and avoiding stand by charges from the Construction Contractor by diverting construction resources to other adjacent projects.

SoCalGas and SDG&E engaged in prudent cost avoidance efforts by engaging in reasonable efforts to promote competitive and market-based rates for contractor services and materials and using a reasonable amount of company and contractor resources, given the complexity of this project.

End of Supply Line 36-9-09 JJ Abandonment Project Final Report

Pipeline Safety Enhancement Plan Final Report
Supply Line 36-9-09 South Abandonment Project

I. SUPPLY LINE 36-9-09 SOUTH ABANDONMENT PROJECT

A. Background and Summary

Supply Line 36-9-09 South is a predominantly [REDACTED] diameter transmission pipeline that runs approximately 1 mile through a commercial area and residential neighborhood from West Church Street to West Enos Drive along Railroad Avenue and South Depot Street in the City of Santa Maria. The pipeline is primarily routed across a Class 3 location. This report describes the activities associated with the Supply Line 36-9-09 South Abandonment Project that consists of the abandonment of 1.239 miles of pipeline. The specific attributes of this Project are detailed in Table 1 below. The total loaded cost of the Project is \$2,340,354.

Table 1: General Project Information

Project Name	Supply Line 36-9-09 South		
Project Type	Abandonment		
Length	1.239 miles		
Location	Santa Maria		
Class	3		
MAOP (<i>confidential</i>)	[REDACTED]		
Pipe Vintage	1951		
Construction Start	04/25/2016		
Construction Finish	06/16/2016		
Original Pipe Diameter (<i>confidential</i>)	[REDACTED]		
New Diameter (<i>confidential</i>)	N/A		
Original SMYS ¹ (<i>confidential</i>)	[REDACTED]		
New SMYS (<i>confidential</i>)	N/A		
Project Costs (\$)	Capital	O&M	Total
Loaded Project Costs	2,338,622	1,732	2,340,354
Disallowed Costs	0	0	0

¹ Highest percentage of Specified Minimum Yield Strength (SMYS) of Category 4 Criteria pipe.

Pipeline Safety Enhancement Plan Final Report
 Supply Line 36-9-09 South Abandonment Project

B. Maps and Images

Figure 1: Map of Supply Line 36-9-09 North PSEP Projects



Pipeline Safety Enhancement Plan Final Report Supply Line 36-9-09 South Abandonment Project

Figure 4: Schematic of Supply Line 36-9-09 South Abandonment Project Northern Isolation

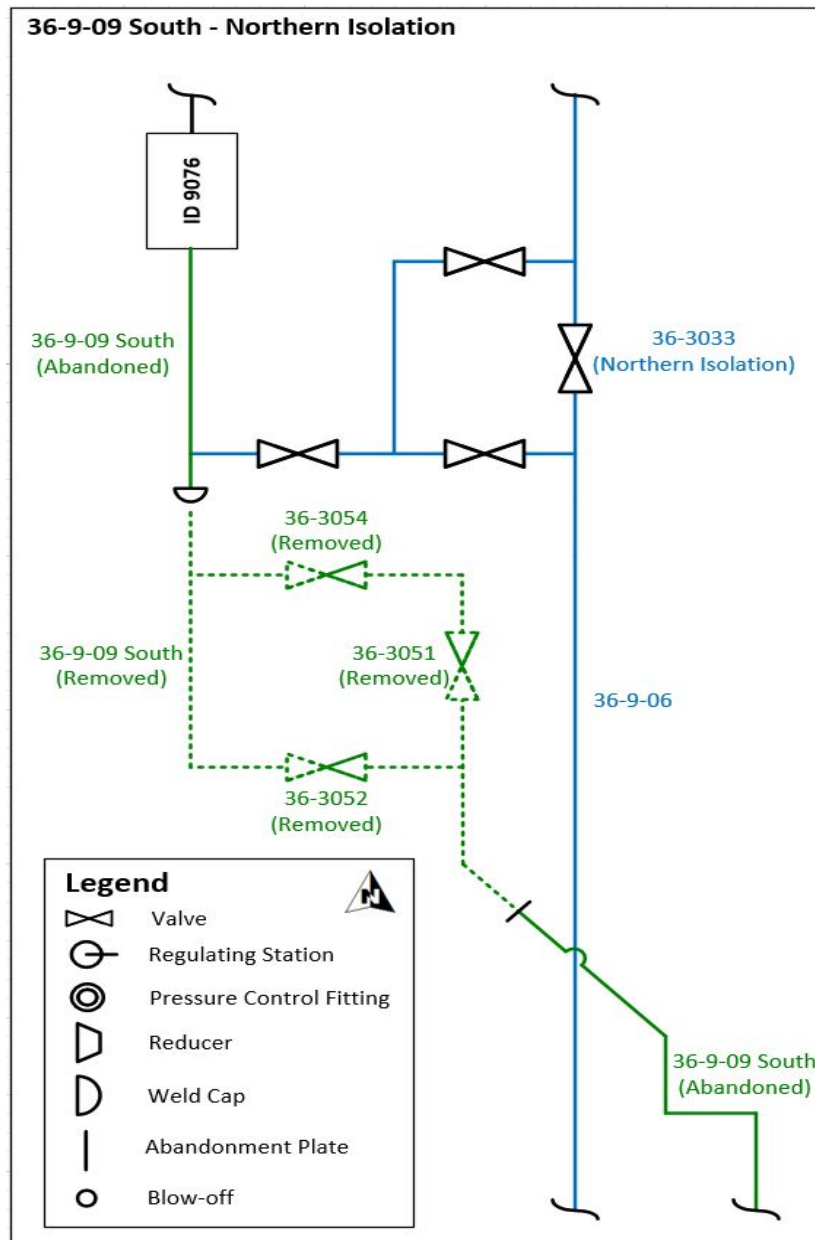

Pipeline Safety Enhancement Plan Final Report Supply Line 36-9-09 South Abandonment Project

Figure 5: Schematic of Supply Line 36-9-09 South Abandonment Project Southern Isolation

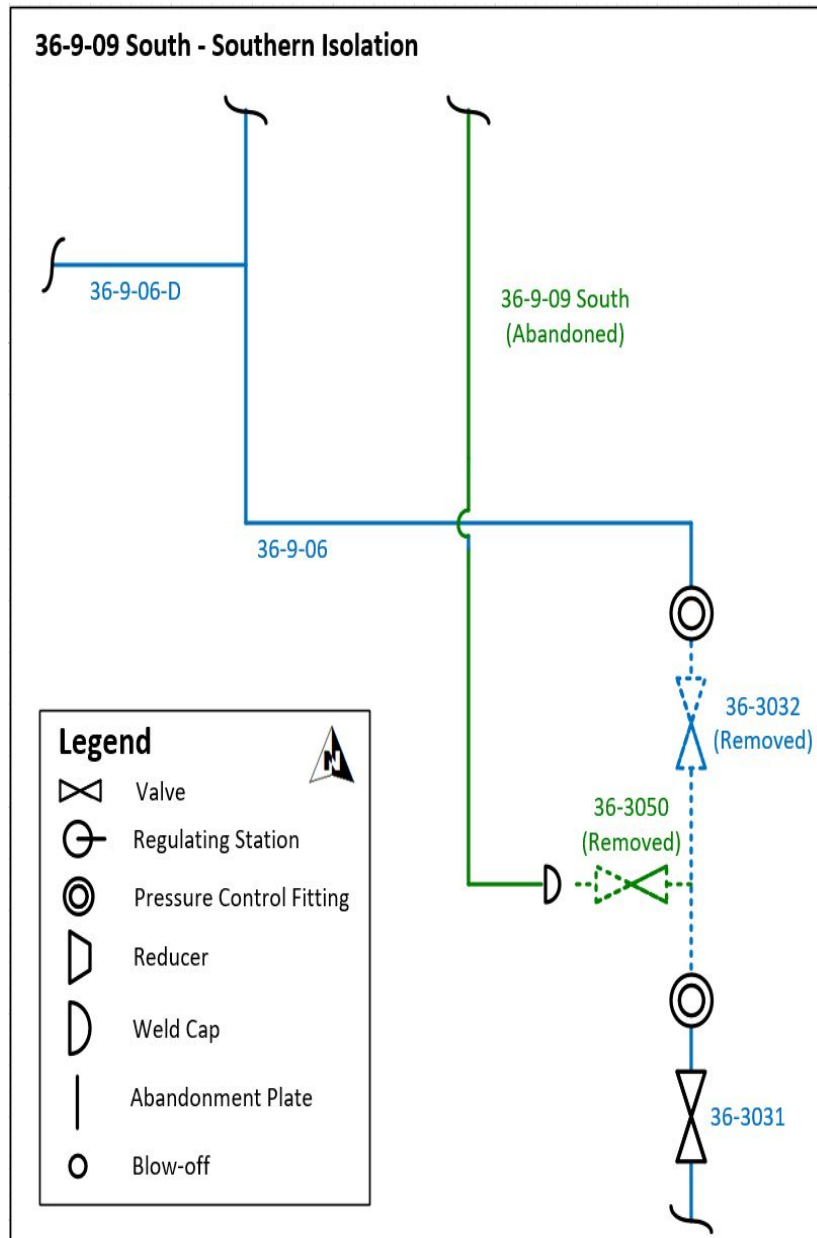

II. ENGINEERING, DESIGN, AND PLANNING

A. Project Scope

Table 2: Mileage Information

	Criteria	Accelerated	Incidental	Total ²
Final Mileage	1.218 mi.	0 mi.	0.021 mi.	1.239 mi.
	6,432 ft.	0 ft.	112 ft.	6,544 ft.

SoCalGas and SDG&E presented a conceptual project scope in workpapers supporting the 2011 PSEP filing.³ Subsequently, SoCalGas and SDG&E identified that 1.216 miles of this line lacked sufficient test records and met the PSEP Phase 1A Criteria. Prior to initiating execution of the Project in 2016, SoCalGas and SDG&E reviewed existing pipeline records to validate the scope of the Project. During the Engineering, Design, and Planning phase, SoCalGas and SDG&E further refined the scope. This progression of the project scope is summarized as follows:

1. 2011 PSEP Filing: SoCalGas and SDG&E identified Supply Line 36-9-09 South as a Phase 1B Project comprised of approximately 2.03 miles of pipe.
2. Scope Validation: Through scope validation activities, after the 2011 filing and before initiating execution of the Project, SoCalGas and SDG&E reclassified this project as a Phase 1A project made up of 1.216 miles of Category 4 Criteria pipe, successfully decreasing the scope of the Project by 0.814 miles.

² Values may not add to total due to rounding.

³ See Amended PSEP of SoCalGas and SDG&E, submitted December 2, 2011, in R.11-02-019 and subsequently transferred to A.11-11-002.

Pipeline Safety Enhancement Plan Final Report
Supply Line 36-9-09 South Abandonment Project

3. Engineering, Design, and Constructability:

- a. SoCalGas and SDG&E determined that Supply Line 36-9-09 South could be abandoned and still maintain system reliability without any customer impacts. Therefore, it was prudent to abandon the line rather than replace it.
- b. The Abandonment of this line consists of the following:
 - i. Removal of three mainline valves (MLV's).
 - ii. Removal of one seven foot by nine foot concrete vault and one seven foot by five foot concrete vault that housed MLV's that were to be abandoned.
 - iii. Cutting the two end points, capping them and removing the line from service. The abandoned pipe would be slurry filled to conform with the requirements set forth by the railroad to eliminate void space. This required intermittently cutting out sections of pipe and welding on a cap and pipe nipple as a slurry mud injection point.
- c. SoCalGas and SDG&E included Incidental mileage in order to fully abandon Supply Line 36-9-09 South.

4. Final Project Scope: The final project scope consists of a 1.239-mile Abandonment. The Incidental mileage consists of 112 feet of pipe.

B. Decision Tree Analysis

SoCalGas and SDG&E performed a PSEP Decision Tree analysis of Supply Line 36-9-09 South and confirmed the project design should commence as an Abandonment Project.

Pipeline Safety Enhancement Plan Final Report
Supply Line 36-9-09 South Abandonment Project

An engineering analysis identified that Supply Line 36-9-09 South is used as a short bypass for Supply Line 36-9-06 to sustain feed from Suey Junction. Based on the engineering evaluation, SoCalGas and SDG&E confirmed that Supply Line 36-9-09 South could be abandoned rather than replaced or hydrotested, and removed from the pipeline system.

Through this Decision Tree analysis, SoCalGas and SDG&E identified abandonment as the more prudent option. Key considerations that support SoCalGas and SDG&E's determination to abandon this segment include:

1. Shut-In Analysis: The Project Team completed a Request for Engineering Review (RER) analysis and concluded that Supply Line 36-9-09 South was used as a short bypass to Supply Line 36-9-06 to sustain feed from Suey Junction. SoCalGas and SDG&E determined that Supply Line 36-9-06 could independently maintain capacity requirements and therefore, Supply Line 36-9-09 South could be abandoned.
2. Customer Impacts: Customers outside of abandonment range would remain uninterrupted by using an existing stopple fitting and installing an additional [REDACTED] stopple fitting. SoCalGas and SDG&E would transfer one customer to an adjacent medium pressure line without interruption.
3. Piggability: Non-piggable.
4. Existing Pipe Attributes: Wrinkle bends.
5. Pipe Vintage: 1951.
6. Longseam Type: Unknown.
7. Longseam Repair History: No identified issues.

Pipeline Safety Enhancement Plan Final Report
Supply Line 36-9-09 South Abandonment Project

8. Condition of Coating: No identified issues.
9. History of Leaks: No identified issues.

C. Engineering, Design, and Planning Factors

SoCalGas and SDG&E reviewed pipeline drawings and other information, contacted internal planning groups, communicated with external stakeholders, conducted survey activities, including reviewing public records of the area to confirm the presence of underground utilities and substructures, and completed a pre-design site walk. Key factors that influenced the engineering and design of the Project are as follows:

1. Community Impact:
 - a. The location to install the stopple fitting at the Battles Road site is within the Santa Maria Valley Railroad right of way (ROW).
 - b. Proximity to nearby businesses would alter the proposed laydown yard location.
 - c. Pedestrian foot traffic was present throughout the various project sites.
 - d. Major streets paralleled the Project alignment and would require traffic control.
2. Permit Conditions: The Project Team delayed construction mobilization from November 30, 2015 to April 25, 2016 due to delays with acquiring a construction permit from Santa Maria Valley Railroad.
3. Land Use: This Project could utilize an existing laydown yard and fabrication space once the adjacent SoCalGas and SDG&E project demobilized.

D. Scope Changes

SoCalGas and SDG&E did not make any notable scope changes during detailed design.

III. CONSTRUCTION

A. Construction Contractor Selection

The Project Team prepared an initial cost estimate based on the preliminary design. Following completion of the engineering, design, and planning activities described above, the Project Team awarded to the contractor that was working on an adjacent SoCalGas and SDG&E (non-PSEP) project, rather than the Performance Partner because of the cost savings benefits of shared resources with Supply Line 36-1007. As indicated above, there were no notable changes in scope between the time when the Project Team prepared the preliminary cost estimate and when the contractor prepared and submitted its sole source estimate.

1. SoCalGas and SDG&E’s Preliminary Construction Cost Estimate (*confidential*):
SoCalGas and SDG&E’s preliminary cost estimate for construction was [REDACTED].
2. Construction Contractor’s Target Price Estimate (*confidential*): The Construction Contractor’s cost estimate was [REDACTED], that was [REDACTED] than SoCalGas and SDG&E’s preliminary cost estimate for construction.

B. Construction Schedule

Table 3: Construction Timeline

Construction Start Date	04/25/2016
Construction Completion Date	06/16/2016
NOP Date	05/26/2016

C. Changes During Construction

The conditions summarized below were encountered during construction. Activities to address or mitigate these conditions resulted in approximately \$68,500 in change orders.

1. Gas Handling: The original shut-in configuration required a blowdown of three pipeline segments. Due to the district's concerns of noise and volume of gas venting to the atmosphere, the operating district decided to install a stopple fitting and reduce the blowdown length.

Pipeline Safety Enhancement Plan Final Report
Supply Line 36-9-09 South Abandonment Project

Figure 6: Welding of Stopple Fitting at Battles Road



Pipeline Safety Enhancement Plan Final Report
Supply Line 36-9-09 South Abandonment Project

Figure 7: Fittings Installed for Gas Handling Operations at Battles Road



D. Decommissioning and Site Restoration

Decommissioning activities include site restoration, final inspections, cut and weld plates on the abandoned lines, installed weld caps on the active lines, disposal of hazardous material, and site demobilization. Closeout activities included development of final drawings, finalization of a reconciliation package, and updates to company recordkeeping systems to reflect the completed scope of work.

IV. PROJECT COSTS

A. Cost Avoidance Actions

SoCalGas and SDG&E exercised due diligence in the planning, design, and construction activities for this project to minimize or avoid costs when prudent to do so. As discussed above, the Project Team conducted a site visit to identify and incorporate discernible site conditions into the engineering, design, and planning of the Project. Specific examples of cost avoidance actions taken on this project are:

1. Construction Execution:

- a. SoCalGas and SDG&E awarded construction to the same contractor that had just completed another SoCalGas and SDG&E non-PSEP project on Supply Line 36-1007 in the same city. This reduced construction mobilization costs and shortened the schedule as the crews were already in the area.
- b. The Project Team kept work hours to eight hour days to avoid overtime fees from the Santa Maria Railroad for railroad flaggers.

B. Cost Estimate

Based on the preliminary design, once the project scope was confirmed and engineering, design, and planning activities were underway, SoCalGas and SDG&E prepared an estimate of the Direct Costs of the Project in the amount of \$3,205,984. This estimate was prepared in October of 2015, using the “SCG Pipeline Estimate Template Rev 3” estimating tool, the most current version of the PSEP Estimate Template at the time. The Project Team considered the conditions known at the time to prepare the preliminary Direct Cost estimate. This estimate reflects the projected Labor, Material, and Services costs anticipated to be incurred to execute the Project

Pipeline Safety Enhancement Plan Final Report
Supply Line 36-9-09 South Abandonment Project

SoCalGas and SDG&E estimated Indirect Costs of the Project based on the estimated Direct Costs and other project-related variables.

C. Actual Direct and Indirect Costs

Actual Direct Costs reflect the Labor, Material, and Service costs incurred to execute the Project. Actual Indirect Costs reflect costs for incremental overhead loaders in accordance with Company overhead allocation policies. The total loaded cost of the Project is \$2,340,354.

Table 4: Estimated and Actual Direct Costs and Variances

Direct Costs (\$)	Estimate	Actuals	Delta Over/(Under)
Company Labor	334,774	99,381	(235,393)
Materials	140,261	47,081	(93,180)
Construction Contractor	1,056,782	558,187	(498,595)
Construction Management & Support	204,248	103,493	(100,755)
Environmental	45,540	62,441	16,901
Engineering & Design	883,465	721,866	(161,599)
Project Management & Services	181,507	115,295	(66,212)
ROW & Permits	20,563	174,461	153,898
GMA	338,844	248,212	(90,632)
Total Direct Costs	3,205,984	2,130,417	(1,075,567)

Table 5: Actual and Estimated Indirect Costs, Total Costs, and Variances

Indirect Costs/Total Costs (\$)	Estimate	Actuals	Delta Over/(Under)
Overheads	393,973	200,294	(193,679)
AFUDC	9,087	8,504	(583)
Property Taxes	2,193	1,139	(1,054)
Total Indirect Costs	405,253	209,937	(195,316)
Total Direct Costs	3,205,984	2,130,417	(1,075,567)
Total Loaded Costs	3,611,237	2,340,354	(1,270,883)

D. Disallowance

The scope of the Supply Line 36-9-09 South Abandonment Project did not include any pipe subject to disallowance under D.14-06-007 or D.15-12-020.

V. CONCLUSION

SoCalGas and SDG&E enhanced the safety of their integrated natural gas transmission system by prudently executing the Supply Line 36-9-09 South Abandonment Project. Through this Abandonment Project, SoCalGas and SDG&E successfully abandoned 1.239 miles of pipe in the City of Santa Maria. The total loaded cost of the Project is \$2,340,354.

SoCalGas and SDG&E executed this project prudently minimizing customer and community impact and avoiding costs through the reuse of construction resources, resulting reductions in mobilization costs, laydown yard costs, material procurement costs, and a shortened schedule.

SoCalGas and SDG&E engaged in prudent cost avoidance efforts to promote competitive and market-based rates for contractor services and materials and used a reasonable amount of company and contractor resources, given the complexity of this project.

I. KERN WILDLIFE BUNDLE ABANDONMENT PROJECT

A. Background and Summary

Supply Line 38-278, Supply Line 38-980 and Supply Line 38-981 (Kern Wildlife Bundle), are predominantly [REDACTED] diameter transmission lines that run approximately 15 miles from the City of Lost Hills in Kern County to Alpaugh in Tulare County, through areas of farmland and the Kern National Wildlife Refuge. The pipeline bundle is primarily routed across a Class 1 location. This report describes the activities associated the Kern Wildlife Bundle Abandonment Project, which consists of the abandonment of 15.225 miles, including 15.061 miles of Accelerated Phase 1B pipe. The specific attributes of this Project are detailed in Table 1 below. The total loaded cost of the Project is \$1,891,807.

These pipelines were not needed for reliability or future capacity purposes and abandoning them would have no customer impacts. Therefore, the Project Team determined it was prudent to abandon the lines rather than replace them. A preliminary cost analysis showed the cost to reroute the Kern Wildlife system would be approximately \$54 million, while the cost to abandon the system would be approximately \$2 million.

Pipeline Safety Enhancement Plan Final Report Kern Wildlife Bundle Abandonment Project

Table 1: General Project Information

Project Name	Kern Wildlife Bundle Abandonment
Project Type	Abandonment
Length	15.225 miles
Location	City of Lost Hills and Alpaugh
Class	1
Construction Start	10/19/2015
Construction Finish	11/20/2015
Original Pipe Diameter (<i>confidential</i>)	██████
New Diameter (<i>confidential</i>)	N/A
New SMYS (<i>confidential</i>)	N/A
Project Name	Supply Line 38-278
Project Type	Abandonment
Length	1.726
Location	Alpaugh
Class	1
MAOP (<i>confidential</i>)	██████
Pipe Vintage	1940
Construction Start	10/19/2015
Construction Finish	11/20/2015
Original Pipe Diameter (<i>confidential</i>)	██████
New Diameter (<i>confidential</i>)	N/A
Original SMYS ¹ (<i>confidential</i>)	██████
New SMYS (<i>confidential</i>)	N/A

¹ Highest percentage of Specified Minimum Yield Strength (SMYS) of Phase 1B pipe.

Pipeline Safety Enhancement Plan Final Report Kern Wildlife Bundle Abandonment Project

Table 1: General Project Information (Continued)

Project Name		Supply Line 38-980		
Project Type	Abandonment			
Length	8.130			
Location	City of Lost Hills			
Class	1			
MAOP (<i>confidential</i>)	[REDACTED]			
Pipe Vintage	1939			
Construction Start	10/19/2015			
Construction Finish	11/20/2015			
Original Pipe Diameter (<i>confidential</i>)	[REDACTED]			
New Diameter (<i>confidential</i>)	N/A			
Original SMYS ² (<i>confidential</i>)	[REDACTED]			
New SMYS (<i>confidential</i>)	N/A			
Project Name		Supply Line 38-981		
Project Type	Abandonment			
Length	5.355			
Location	City of Lost Hills and Alpaugh			
Class	1			
MAOP (<i>confidential</i>)	[REDACTED]			
Predominant Pipe Vintage	1943			
Construction Start	10/19/2015			
Construction Finish	11/20/2015			
Original Pipe Diameter (<i>confidential</i>)	[REDACTED]			
New Diameter (<i>confidential</i>)	N/A			
Original SMYS ³ (<i>confidential</i>)	[REDACTED]			
New SMYS (<i>confidential</i>)	N/A			
Project Costs (\$)		Capital	O&M	Total
Loaded Project Costs		1,888,221	3,586	1,891,807
Disallowed Costs		-	-	-

² Ibid

³ Ibid.

Pipeline Safety Enhancement Plan Final Report
Kern Wildlife Bundle Abandonment Project

B. Maps and Images

Figure 1: Satellite Image of Kern Wildlife Abandonment Project

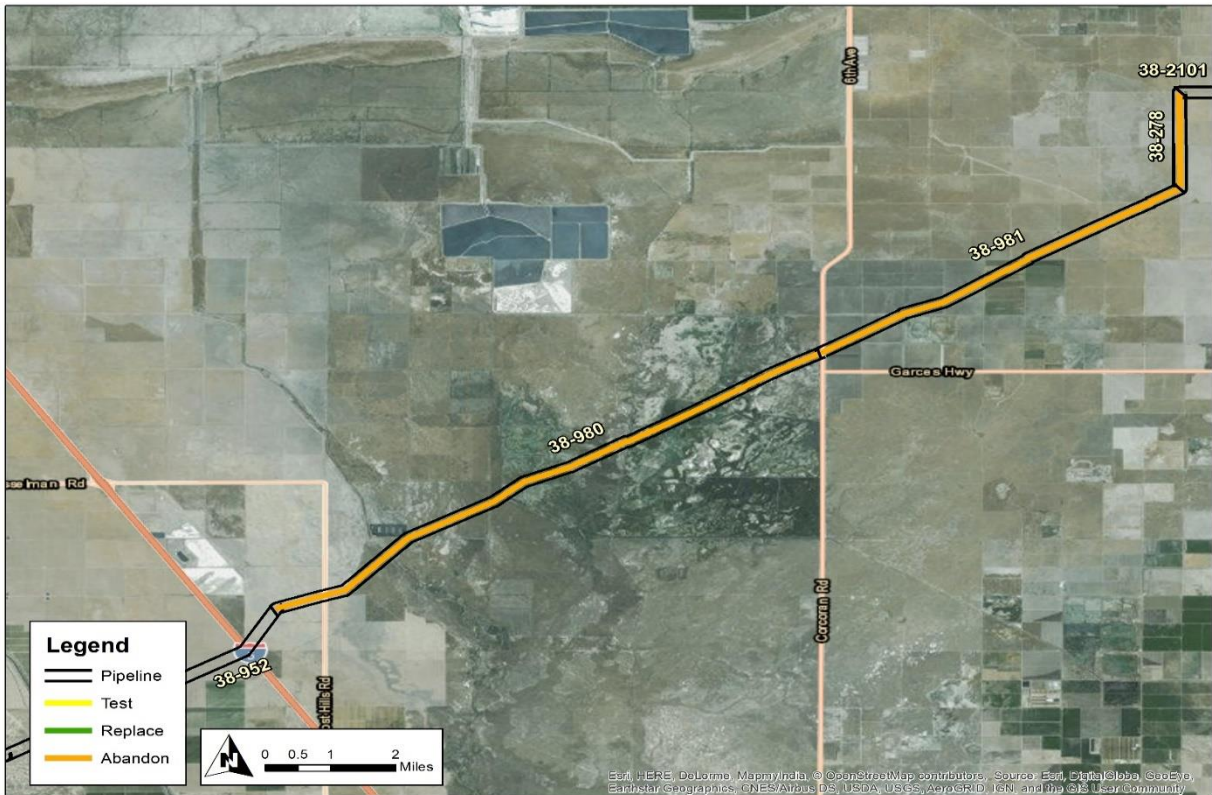

Pipeline Safety Enhancement Plan Final Report Kern Wildlife Bundle Abandonment Project

Figure 2: Overview Map of Kern Wildlife Bundle Abandonment Project

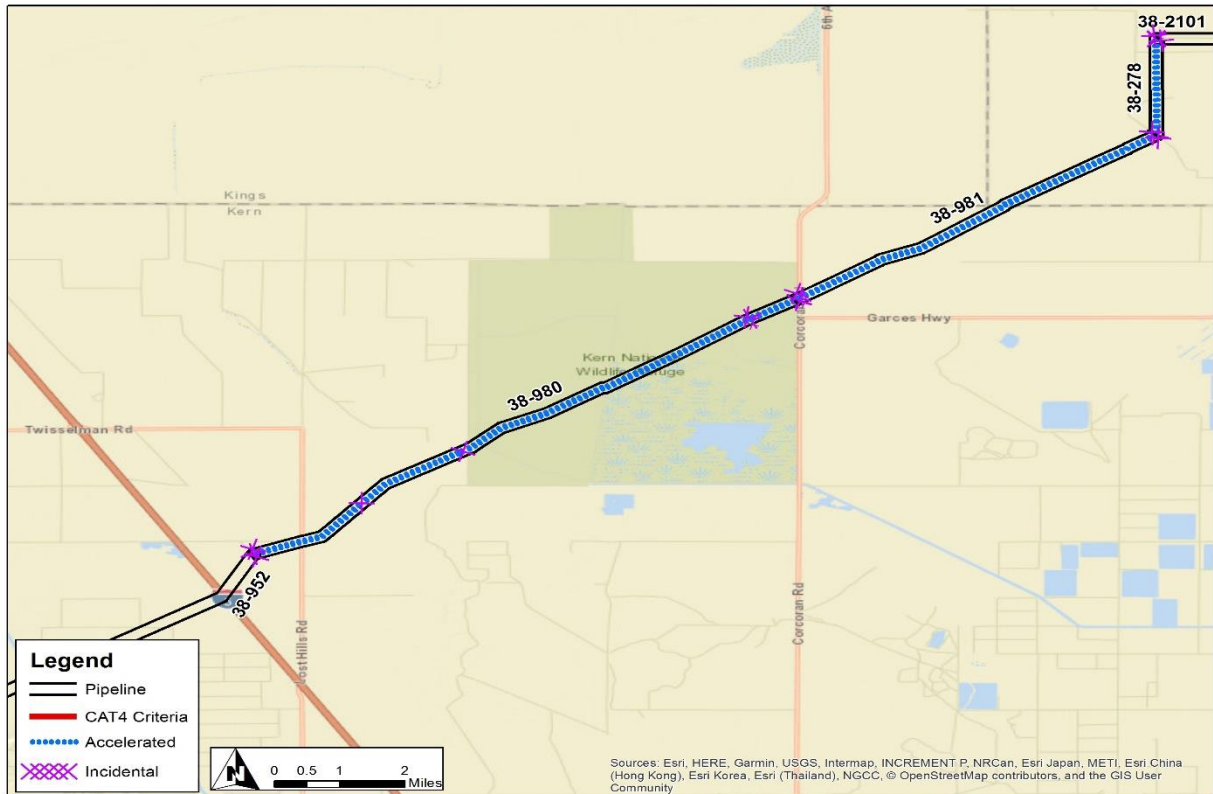

II. ENGINEERING, DESIGN, AND PLANNING

A. Project Scope

Table 2: Mileage Information

	Criteria	Accelerated ⁴	Incidental	Total ⁵
Final Mileage	0.000 mi.	15.132 mi.	0.093 mi.	15.225 mi.
	0 ft.	79,897 ft.	492 ft.	80,389 ft.

SoCalGas and SDG&E presented a conceptual project scope in workpapers supporting the 2011 PSEP filing.⁶ Prior to initiating execution of the Project in 2015, SoCalGas and SDG&E reviewed existing pipeline records to validate the scope of the Project. During the Engineering, Design, and Planning phase, SoCalGas and SDG&E further refined the scope. This progression of the project scope is summarized as follows:

1. 2011 PSEP Filing: SoCalGas and SDG&E identified the Kern Wildlife Bundle as a Phase 1A Abandonment Project comprised of approximately 15 miles of Phase 1B pipe.
2. Scope Validation: Through scope validation activities, after the 2011 filing and before initiation of the Project, SoCalGas and SDG&E identified 15.201 miles of Phase 1B pipe.

⁴ Accelerated mileage includes Phase 1B and Phase 2A. Phase 2A includes pipelines without sufficient record of a pressure test in less populated areas. The Accelerated mileage was included to realize efficiencies and to enhance project constructability.

⁵ Values may not add to total due to rounding.

⁶ See Amended PSEP of SoCalGas and SDG&E, submitted December 2, 2011, in R.11-02-019 and subsequently transferred to A.11-11-002.

Pipeline Safety Enhancement Plan Final Report
Kern Wildlife Bundle Abandonment Project

3. Engineering, Design, and Constructability:

- a. Through engineering analysis, SoCalGas and SDG&E determined that the Kern Wildlife Bundle was not needed for reliability or future capacity purposes and abandoning them would have no customer impacts. Therefore, the Project Team determined it was prudent to abandon the line rather than replace it. A cost analysis showed the cost to reroute the Kern Wildlife Bundle system would be approximately \$54 million, while the cost to abandon the system would be approximately \$2 million.
- b. SoCalGas and SDG&E determined that the Kern Wildlife Bundle could be abandoned and still maintain system reliability without any customer impacts. Incidental pipe was included in order to fully abandon the Kern Wildlife Bundle to remove additional piping and to prevent collection of water within the short segments.
- c. The abandonment of this line consists of cutting the two end points, capping them, and then removing the line from service.

4. Final Project Scope: The final project scope consists of a 15.225 mile Abandonment. The Accelerated mileage consisted of 15.062 miles of Phase 1B pipe, 0.070 miles of Phase 2A pipe and 0.093 miles of Incidental pipe.

B. Decision Tree Analysis

SoCalGas and SDG&E performed a PSEP Decision Tree analysis of the Kern Wildlife Bundle and confirmed the project design should commence as an Abandonment Project.

Pipeline Safety Enhancement Plan Final Report Kern Wildlife Bundle Abandonment Project

For pipeline segments longer than 1,000 feet in length, under the approved PSEP Decision Tree, SoCalGas and SDG&E completed a preliminary review to determine whether SoCalGas and SDG&E can manage customer service impacts if the pipeline segment is taken out of service for a period of two to six weeks to complete pressure testing. Where mitigation of customer impacts to remove the line from service for pressure testing is feasible, SoCalGas and SDG&E compare the costs, constructability, risks, and benefits of pressure testing and replacement to determine whether pressure testing, replacement or abandonment is the more prudent option.

Through this Decision Tree analysis, SoCalGas and SDG&E identified abandonment as the more prudent option. Key considerations that support SoCalGas and SDG&E's determination to abandon this segment include:

1. Pipe Vintage: 1939
2. Piggability: Non-piggable.
3. Existing Pipe Attributes:
 - a. Supply Line 38-278 contains three taps that are greater than ½ - inch outer diameter off the mainline.
 - b. Supply Line 38-980 contains one unbarred tee.
4. Longseam Type:
 - a. Supply Line 38-278 – Unknown, helical/spiral submerged arc weld and electric resistance welded.
 - b. Supply Line 38-980 – Unknown.
 - c. Supply Line 38-981 – Unknown and helical/spiral submerged arc weld.

Pipeline Safety Enhancement Plan Final Report
Kern Wildlife Bundle Abandonment Project

5. Longseam Repair History:

a. Supply Line 38-278

- i. 1969, Replacement of existing pipe with helical/spiral submerged arc weld.
- ii. 1975, Replacement of existing pipe with electric resistance welded.

b. Supply Line 38-980 – No identified issues.

c. Supply Line 38-981 – 1969, Replacement of existing pipe with helical/spiral submerged arc weld.

6. Condition of Coating: Existing pipe coating is coal tar. Project documentation showed no issues with the existing pipe coating condition.

7. History of Leaks: No identified issues.

C. Engineering, Design, and Planning Factors

SoCalGas and SDG&E reviewed pipeline drawings and other information, contacted internal planning groups, communicated with external stakeholders, conducted survey activities, including reviewing public records, to confirm the presence of underground utilities and substructures, and completed a pre-design site walk. Key factors that influenced the engineering and design of the Project are as follows:

1. Shut-In Analysis: The Project Team completed a Request for Engineering Review (RER) analysis and concluded the existing lines could be shut-in, and no customers are directly connected to the Kern Wildlife Bundle system.
2. Customer Impacts: The Project Team can use pressure control fittings (PCFs) to isolate the Kern Wildlife Bundle from Supply Line 38-952 and Supply Line 38-2101 without any customer impacts.

Pipeline Safety Enhancement Plan Final Report Kern Wildlife Bundle Abandonment Project

3. Environmental: The Kern Wildlife land is under the jurisdiction of the United States Fish and Wildlife Service (USFWS) and is covered under the San Joaquin Valley Programmatic Biological Opinion.

D. Scope Changes

Through engineering, design, and planning activities, SoCalGas and SDG&E determined that changes in scope were appropriate to enhance the design of the Project and address engineering factors. Following receipt of the RER analysis, it was determined that the option for abandonment could be pursued and still maintain system reliability without any customer impacts. As part of the standard procedure for confirming abandonment as a feasible option, PSEP coordinated with the Operating District and validated the RER analysis by performing a test shut-in. A preliminary cost analysis showed the cost to abandon the system would be approximately \$2 million compared to the cost of approximately \$54 million to reroute 20.4 miles of the Kern Wildlife system along existing farm roads to avoid crop damage on existing farmland and environmental concerns of the replacing through the Kern National Wildlife Refuge.

III. CONSTRUCTION

A. Construction Contractor Selection

The Project Team prepared an initial cost estimate based on the preliminary design. Following completion of the engineering, design, and planning activities described above, the Project Team directed the Performance Partner to prepare cost estimates based on a more detailed engineering design package, which included the updated design described in the discussion of notable Scope Changes above. SoCalGas and SDG&E awarded the construction contract to the Performance Partner.

1. SoCalGas and SDG&E’s Preliminary Construction Cost Estimate (*confidential*): SoCalGas and SDG&E’s preliminary cost estimate for construction was [REDACTED].
2. Construction Contractor’s Target Price Estimate (*confidential*): The Construction Contractor’s cost estimate was [REDACTED], which was [REDACTED] than SoCalGas and SDG&E’s preliminary cost estimate for construction.

B. Construction Schedule

Table 3: Construction Timeline

Construction Start Date	10/19/2015
Construction Completion Date	11/20/2015
NOP Date	11/06/2015

C. Changes During Construction

SoCalGas and SDG&E successfully mitigated conditions during construction in a manner that minimized potential impacts on project scope, cost, and schedule. As a result, these conditions did not result in any notable change orders.

Pipeline Safety Enhancement Plan Final Report
Kern Wildlife Bundle Abandonment Project

Figure 3: PCF Installation



Pipeline Safety Enhancement Plan Final Report
Kern Wildlife Bundle Abandonment Project

Figure 4: PCF Installation to Complete Abandonment



Pipeline Safety Enhancement Plan Final Report Kern Wildlife Bundle Abandonment Project

D. Decommissioning and Site Restoration

Decommissioning activities included site restoration, final inspections, cut and weld plates on the abandoned lines, installed weld caps on the active lines, disposal of hazardous material, and demobilization from the site. Closeout activities included development of final drawings, finalization of a reconciliation package, and updates to company recordkeeping systems to reflect the completed scope of work.

IV. PROJECT COSTS

A. Cost Avoidance Actions

SoCalGas and SDG&E exercised due diligence in the planning, design, and construction activities for this project to minimize or avoid costs when prudent to do so. As discussed above, the Project Team conducted a site visit to identify and incorporate discernible site conditions into the engineering, design, and planning of the Project. Specific examples of cost avoidance actions taken on this project are:

1. Land Use: The Project Team used laydown yard locations on private property to avoid municipal permitting and traffic control costs.
2. Scope Change: The Project Team achieved cost savings by changing the project scope from replacement to abandonment. A preliminary cost analysis showed the cost to reroute the Kern Wildlife system would be approximately \$54 million, while the cost to abandon the system would be approximately \$2 million.

B. Cost Estimate

Based on the preliminary design, once the project scope was confirmed and engineering, design, and planning activities were underway, SoCalGas and SDG&E prepared an estimate of the Direct Costs of the Project in the amount of \$1,761,301. This estimate was prepared in September of 2015 using the “SCG Pipeline Estimate Template Rev 3” estimating tool, the most current version of the PSEP Estimate Template at the time.

Pipeline Safety Enhancement Plan Final Report
Kern Wildlife Bundle Abandonment Project

The Project Team considered the conditions known at the time to prepare the preliminary Direct Cost estimate. This estimate reflects the projected Labor, Material, and Services costs anticipated to be incurred to execute the Project.

SoCalGas and SDG&E estimated Indirect Costs of the Project based on the estimated Direct Costs and other project-related variables.

C. Actual Direct and Indirect Costs

Actual Direct Costs reflect the Labor, Material, and Service costs incurred to execute the Project. Actual Indirect Costs reflect costs for incremental overhead loaders in accordance with Company overhead allocation policies. The total loaded cost off the Project is \$1,891,807.

Table 4: Estimated and Actual Direct Costs and Variances

Direct Costs (\$)	Estimate	Actuals	Delta Over/(Under)
Company Labor	221,430	81,097	(140,333)
Materials	12,503	24,804	12,301
Construction Contractor	809,600	600,415	(209,185)
Construction Management & Support	49,906	116,941	67,035
Environmental	127,600	86,361	(41,239)
Engineering & Design	220,000	537,337	317,337
Project Management & Services	128,608	62,164	(66,444)
ROW & Permits	5,500	24,045	18,545
GMA	186,154	204,472	18,318
Total Direct Costs	1,761,301	1,737,636	(23,665)

Pipeline Safety Enhancement Plan Final Report
Kern Wildlife Bundle Abandonment Project

Table 5: Estimated and Actual Indirect Costs, Total Costs, and Variances

Indirect Costs/Total Costs (\$)	Estimate	Actuals	Delta Over/(Under)
Overheads	271,398	154,171	(117,227)
AFUDC	-	-	-
Property Taxes	-	-	-
Total Indirect Costs	271,398	154,171	(117,227)
Total Direct Costs	1,761,301	1,737,636	(23,665)
Total Loaded Costs	2,032,699	1,891,807	(140,892)

D. Disallowance

The scope of the Kern Wildlife Bundle Abandonment Project (Supply Line 38-278, Supply Line 38-980 and Supply Line 38-981) did not include any pipe subject to disallowance under D.14-06-007 or D.15-12-02.

Pipeline Safety Enhancement Plan Final Report
Kern Wildlife Bundle Abandonment Project

V. CONCLUSION

SoCalGas and SDG&E enhanced the safety of their integrated natural gas transmission system by prudently executing the Kern Wildlife Refuge Bundle Abandonment Project. Through this Abandonment Project, SoCalGas and SDG&E successfully abandoned 15.225 miles of pipeline in the City of Lost Hills and Alpaugh. The total loaded cost of the Project is \$1,891,807.

SoCalGas and SDG&E executed this project prudently through minimizing customer impacts, avoiding impacts on a national wildlife preserve, and choosing to abandon the Kern Wildlife Bundle based on analysis of the system.

SoCalGas and SDG&E engaged in prudent cost avoidance efforts by strategically selecting a laydown yard site that did not require traffic control activity and costs; designing and executing this project for abandonment rather than rerouting the pipeline around the wildlife refuge, and engaged in reasonable efforts to promote competitive and market-based rates for contractor services and materials.

End of Kern Wildlife Refuge Bundle Abandonment Project Final Report