

APPENDIX 5.9-A

**SDG&E BEST MANAGEMENT PRACTICES MANUAL FOR WATER QUALITY
CONSTRUCTION**

M A N U A L



BEST MANAGEMENT PRACTICES MANUAL FOR WATER QUALITY CONSTRUCTION

Geosyntec Project No. SW0186

December 2010, Rev 2- Geosyntec Consultants
Revised July 2011, San Diego Gas & Electric Environmental Services Department

Table of Contents

Why Is There A Need for This Manual?.....	ii
A Note Regarding Impacts to Construction Cost and Scheduling.....	iii
BMP Program Overview.....	1
BMP Selection and Implementation.....	3
Table 1 BMP SELECTION AND SEQUENCING GUIDE.....	5
Table 2 BMP SELECTION WORKSHEET FOR UTILITY ACTIVITIES.....	7
BMP Details.....	10
Section 1 - Sediment Controls.....	11
Section 2 - Waste Management and Material Controls.....	42
Section 3 - Non-Storm Water Discharge Controls.....	60
Section 4 - Soil Erosion Control.....	87
References.....	120
Appendix A Definitions and Acronyms.....	121

Why Is There A Need for This Manual?

Sempra Energy's Environmental Policy states in part, "Sempra Energy believes in treating the Earth's resources with respect. We are committed to protecting and conserving the environment and the health and the safety of our employees, our customers, and the diverse communities in which we operate and provide service." Therefore, Sempra Energy companies will:

- Meet applicable environmental laws, regulations, and permit requirements.
- Join customers, civic leaders and other community leaders in providing sound and responsible stewardship of our environment.
- Incorporate appropriate environmental management and compliance in strategic planning and operational decisions."

Municipalities (Cities, Counties, and Special Districts) have passed storm water ordinances intended to protect storm sewer systems and receiving water bodies from sediment, chemical, and biological pollutants. These ordinances require storm water Best Management Practices (BMPs) for construction projects and construction activities that disturb soil. Due to the numerous municipalities in the San Diego Gas & Electric (SDG&E) service territory, there is a need to consolidate the various municipal BMP requirements for consistent and cost effective construction practices. This manual has been written to supplement the operational procedures of SDG&E to meet the municipal storm water ordinance requirements within SDG&E's service territory. Municipal storm water ordinances include prohibitions regarding erosion, sedimentation and discharge of other pollutants without reference to soil disturbance area and include construction "like" activities that include construction or operation and maintenance activities that can impact the municipal storm water conveyance systems. These activities include saw cutting, potholing, trenching, excavation (including trench and excavation dewatering) and stockpiling. Therefore, this BMP manual is applicable to the above construction and construction "like" activities, including field operations and maintenance activities, regardless of soil disturbance area or its location. This manual is also applicable to construction "like" activities at SDG&E facilities, such as Construction & Operations (C&O) facilities, supplementing the Facility Storm Water Management Plan (SWMP) or Storm Water Pollution Prevention Plan (SWPPP) BMPs.

Construction or demolition activities that include any land disturbance of one (1) acre or more are subject to storm water control regulations in the California Construction General Storm Water Discharge Permit (CGP) established by the California State Water Resources Control Board (SWRCB) Order No. 2009-009-DWQ. This CGP has many new requirements compared to the previous permit (Order No. 99-08-DWQ) and requires electronic submittal of the Notice of Intent (NOI), risk assessment, site map, project specific SWPPP, and annual report requirements. Projects subject to the CGP must establish a project-specific construction site risk level based on the site-specific sediment discharge risk and the site's receiving water risk. These two factors are used to determine the project risk, which is assigned as Risk Level 1, 2, or 3 for traditional (non-linear) projects or Type 1, 2, or 3 for linear underground/overhead (LUP) projects. CGP requirements are more stringent for higher Risk Levels or Types. The CGP established numeric discharge limits for turbidity and pH for Risk Level/Type 2 and 3 sites. All projects risk levels/types must implement minimum BMPs and perform visual monitoring in accordance with the CGP. In addition, the CGP has specific certification requirements for those that prepare SWPPPs (i.e., "Qualified SWPPP Developers") and those that implement requirements in the field (i.e., "Qualified SWPPP Practitioners").

The purpose is to update the manual and BMP details to reflect requirements of the new California Construction General Storm Water Discharge Permit (CGP) (California State Water Resources Control Board (SWRCB) Order No. 2009-009-DWQ), which became effective on July 1, 2010 as well as to update information related to SDG&E operations and activities.

Many of the construction activities of SDG&E are linear in nature, unique to utility work, and do not correspond to typical large development project BMPs. There is a continuing need to tailor typical BMPs to utility type work and utility work crews. This manual incorporates the above mandates of Sempra Energy's Environmental Policy. The manual is the result of surveying the available governmental, association, and industry sources of construction BMPs, and the selection and editing of BMPs appropriate to SDG&E construction activities and personnel.

A Note Regarding Impacts to Construction Cost and Scheduling

It is important for a project's or activity's budget and schedule to include BMP selection, implementation and maintenance costs and time horizons into the design and construction of a project. It is also important that there is a mechanism to hand-off the BMP portion of a project to the appropriate SDG&E Operations and Maintenance Department for final stabilization and post-project permanent BMP maintenance (including final and post-construction costs). A project's field Environmental Representative will be able to assist in estimating and incorporating these costs and scheduling considerations into the project or construction activity.

BMP PROGRAM OVERVIEW

Water Quality Construction BMP Manual

The purpose of this Water Quality Construction BMP Manual (Manual) is to provide standardized BMPs to reduce or eliminate pollutants in runoff from SDG&E construction projects and construction activities for water quality protection. This Manual applies to SDG&E's construction projects and activities that disturb soil. This manual also applies to SDG&E's contractors performing such work as part of their contractual obligations. SDG&E's service area encompasses approximately 4,000 square miles of diverse terrain from Southern Orange County to the Mexican border. Many of SDG&E's projects and work activities throughout the service area are subject to coverage under the National Pollutant Discharge Elimination System (NPDES) CGP and its conditions, and/or local municipal storm water ordinance requirements. Because of the breadth of jurisdictions and requirements that apply to SDG&E's utility construction projects and activities, this Manual has been developed to provide a consistent approach to water quality management to be applied by SDG&E and their contractors throughout the SDG&E service area.

Most construction projects performed by SDG&E are linear projects which are often short term, and are low impact on narrow corridors of land. Many of the BMPs presented in this Manual have used the best and most practical pollution prevention features from several sources, such as the SWRCB, the California Stormwater Quality Association (CASQA), local municipalities, and California Department of Transportation (Caltrans) BMP Manuals, that have been modified to integrate into our utility construction activities but are also compliant with the applicable regulations and ordinances.

This Manual is organized into three main sections:

- BMP Program Overview.
- BMP Selection and Implementation.
- BMP Details.

The BMP Details section is divided into four functional BMP categories:

- Sediment Controls.
- Waste and Materials Management Controls.
- Non-Storm Water Discharge Controls.
- Erosion Control.

Within each of these categories, specific information, including "What," "When," "Where" and "How" to implement the BMP, plus maintenance and inspection information, are provided for each BMP. Pictures and diagrams are also provided for many of the BMPs for easy reference. Photographs provided in this Manual have been primarily obtained from URS Corporation, Geosyntec Consultants, California Department of Transportation (Caltrans), CASQA, and SDG&E.

The Manual is a tool designed to assist with the identification of BMPs appropriate for use on a construction or activity site. The Manual provides guidance to SDG&E for meeting regulatory water quality requirements for utility construction and maintenance activities that involve disturbance of soil. The BMP selection process provides users with guidance for the selection of typical BMPs that may apply to standard SDG&E construction activities. During BMP selection, the users of this Manual should take into account the benefits and limitations of each of the BMPs considered in the context of the site conditions. Finally, BMP success is contingent not only on appropriate selection and implementation, but also on the coordination and communication between project management, Field Environmental Representatives, and the field construction teams.

BMP PROGRAM OVERVIEW

Utility Type Projects

Most SDG&E projects are very different from commercial or residential developments, building sites, and Caltrans projects. Many SDG&E projects are smaller, short term, and impact narrow corridors of land. SDG&E projects are constantly progressing along the route. Often, SDG&E projects are in the right-of-ways of streets or along SDG&E utility corridors that must be maintained to ensure safe access to gas and electric lines and where temporary BMPs are initially installed for a short period of time during construction, followed by soil stabilization BMPs as necessary.

Training Program

Training for construction storm water pollution prevention and control is part of SDG&E's overall Water Quality Pollution Prevention Program. All applicable company employees and contractors hired by the company have the responsibility to comply with environmental laws, regulations, and permit requirements. Training for the prevention of environmental-related incidents is conducted for applicable SDG&E employees who perform any operation or activity that has the potential to cause a pollutant to be released into the environment, including construction activity. Records are maintained as to when employees have received this training and instruction.

Contractor responsibilities, including environmental training of their employees, are specified in the terms and conditions of the contract between SDG&E and the contractor.

Applicable employees should know and contact their local Field Environmental Representatives for support and guidance on any aspects of the training program.

BMP SELECTION AND IMPLEMENTATION

General Protocol BMP

To select BMPs that are appropriate for a given project, the following steps should be followed:

- Step 1 - In the project's design phase, identify "Permanent" or "Structural" BMPs required by the local municipality or the CGP. These BMPs are often stated in the requirements as "Post-Construction" or "Permanent" BMPs.
- Step 2 - Identify construction activities and the associated pollutants and issues of concern
- Step 3 - Evaluate site conditions and select applicable BMPs
- Step 4 - Implement, monitor, and maintain the BMPs

Step 1 - Identify "Permanent" or "Structural" BMPs required by Local Municipalities and/or the SWRCB General Construction Storm Water Permit.

Municipalities may have a Standard Urban Stormwater Mitigation Plan (SUSMP) or equivalent, and other requirements such as a requirement for conformance with the California Green Building Standards Code (CalGreen Code). These Plans and Codes may require:

- Permanent stabilization of exposed soil surfaces and slopes to minimize erosion and sedimentation. Stabilization structures and/or the planting of vegetation may be required.
- Matching post-construction runoff to pre-construction runoff, utilizing the 85th percentile storm event to reduce the risk of impact to the receiving water's channel morphology and provide some protection of water quality.
- Use of Low Impact Development (LID) practices. LID practices are environmentally sustainable practices that benefit water supply and contribute to water quality protection. Unlike traditional storm water management, which collects and conveys storm water runoff through storm drains, pipes, or other conveyances to a centralized storm water facility or outfall, LID takes a different approach by using site design and storm water management to maintain the site's pre-development runoff rates and volumes. LID practices include; Impervious surface reduction & disconnection; bio-retention facilities or rain gardens, grass swales and channels, vegetated rooftops, rain barrels, cisterns, vegetated filter strips, and permeable pavements.

Step 2 - Identify Activities, Pollutants, and Issues of Concern

The second step in BMP selection is to identify the construction activities, the associated potential pollutants, and the local issues of concern. Construction activities may include saw cutting, potholing, trenching, excavation, stockpiling of soil, grading and grubbing, new access road construction, paving, or other activities with the potential to impact storm water and non-storm water discharges. Pollutants of concern may include: sediment; petroleum products such as fuel, oil, and grease from vehicle and equipment operation; paving materials such as concrete and asphalt components; other materials used or stored on site, such as pesticides, herbicides, fertilizer, detergents, paint, adhesives, and solvents; and project wastes such as litter, debris, hazardous wastes, and liquid wastes. The local issues of concern may include:

- Proximity to sensitive receiving waters (environmentally sensitive areas or Clean Water Act Section 303(d) listed water bodies, particularly those meeting the criteria for "sediment sensitive" receiving waters identified in the CGP, example: Upper Newport Bay
- Local regulatory requirements influencing BMP selection, or timing of BMP implementation.

BMP SELECTION AND IMPLEMENTATION

Step 3 - Evaluate Site Conditions and Select BMPs

To assist in BMP selection, this Manual presents BMPs that are anticipated to be most applicable to utility construction projects and construction activities. Most SDG&E utility projects are unique in that they are typically very short-term, low impact on narrow corridors of land, and have minimal exposure of soil or transportable materials at any one time to storm water. The selector should consider any project-specific requirements or factors such as BMP effectiveness, cost, availability, feasibility, and suitability for the site. For example, important site conditions to consider include the amount of soil disturbance, anticipated weather conditions, soil type and erodibility, flow path length, and slope of exposed soil. Selected BMPs can and should be modified to suit the scope of the project and site conditions.

Table 1 presents guidelines for BMP selection and implementation at a construction site. Table 2 presents a BMP selection worksheet for utility activities. These implementation guidelines and selection worksheet can be used to select BMPs for a specific project or construction activity. Finally, a selector may discover a better BMP for their situation not listed in Tables 1 or 2. The Environmental Services Department encourages creative and practical pollution prevention techniques. These new techniques can be shared with others to support the water quality goals of the region.

Step 4 - Implement, Monitor, and Maintain the BMP System

It is important that selected BMPs be implemented in a sequence that maximizes protection of water quality, be monitored regularly for effectiveness and be maintained as necessary throughout the project. Appropriate BMPs must be implemented year round. Additional BMPs will be implemented when needed, and/or when a storm event is forecasted or occurs. Table 1 presents a suggested schedule for BMP implementation and sequencing. Steps in this schedule should be reviewed for each project as applicable. All BMPs should be monitored and inspected regularly and particularly before and after rain events, or in compliance with the frequency specified in the CGP, if applicable. BMPs should be maintained during a project in accordance with the procedures outlined in the BMP Details Section.

BMP Installation Contractors and BMP Material Suppliers

Construction crews will implement most BMPs. This Manual identifies some SDG&E utility activities and operations that may require outside contractors to install the applicable BMPs. As needed, please consult with the Environmental Services Department, Water Quality for the most current contractor listings and contractual arrangements.

BMP SELECTION AND IMPLEMENTATION

**Table 1
BMP SELECTION AND SEQUENCING GUIDE**

Step No.	Description	What to Do	BMP Options (see Table 2 for BMP activities)
1.	Design Stage and Before Construction	Contact the Field Environmental Representative early, at the beginning of a project, and provide him/her with the project information on the current environmental project information form. This information will allow the Environmental Department to identify environmental concerns such as, but not limited to, permitting requirements, potentially required structural BMPs, and the identification of endangered species and/or impaired water bodies that must be avoided or mitigated. As another example, before construction, it may be necessary to evaluate, mark, and protect important trees and associated rooting zones, unique areas (e.g., wetlands), and other areas to be preserved.	Local SUSMP, CalGreen Code, or General Construction Storm Water Permit requirements 4-01, other user-defined BMPs
2.	Site Access Areas (construction entrances, roadways, equipment parking areas)	Stabilize site entrances and access roads if applicable prior to earthwork.	1-07, other user-defined BMPs
3.	Storm Drain/Drainage Inlet Protection	Install inlet protection at down-gradient inlets that project runoff/tracking might impact.	1-06, other user-defined BMPs
4.	Perimeter Sediment Control	Install perimeter sediment controls (silt fence, fiber rolls, etc.) as applicable prior to soil disturbing activities. Install additional runoff control measures during construction as needed.	1-02, 1-03, 1-04, 1-05, other user-defined BMPs
5.	Material and Waste Storage Areas	Prepare staging areas and material storage and disposal areas, as applicable, to reduce run-on and runoff. Install perimeter control, obtain clean-up materials, plastic covers for stockpiles, etc. prior to storing materials on site.	2-01 through 2-08, 1-08, other user-defined BMPs
6	Drainage Control and Run-on Diversion	Install run-on controls to direct run-on around or through the site to minimize erosion in addition to sediment control measures.	4-01 through 4-13, other user-defined BMPs
7.	Earthwork (trenching, excavation, grading, surface roughening, grubbing)	Begin excavation, trenching, or grading after installing applicable sediment and runoff control measures. Install additional control measures as work progresses as needed.	1-01 through 1-08, other user-defined BMPs
8.	Surface Stabilization (temporary and permanent seeding, mulching)	Apply temporary or permanent soil stabilization measures as applicable on all disturbed areas where work is delayed or completed.	4-01 through 4-08, other user-defined BMPs

BMP SELECTION AND IMPLEMENTATION

**Table 1 (continued)
BMP SELECTION AND SEQUENCING GUIDE**

Step No.	Description	What to Do	BMP Options (see Table 2 for BMP activities)
9.	Construction and Paving (install utilities, buildings, paving)	Implement applicable control practices as work takes place.	3-01 through 3-9, other user-defined BMPs
10.	Final Stabilization and Landscaping	Stabilize open areas as applicable. Remove temporary control measures and install final stabilization controls appropriately (topsoil, trees and shrubs, permanent seeding, mulching, sod, riprap)	3-07, 4-03, 4-04, other user-defined BMPs

BMP SELECTION AND IMPLEMENTATION

Table 2
BMP SELECTION WORKSHEET FOR UTILITY ACTIVITIES

Utility BMP No.	BMP Options	Construction					Maint. and Repair				
		Overhead Electric	Underground Electric	Potholing	Underground Gas	Boring/Directional Drilling	Pipe Spans	Gen. Maint. and Repair	Inspect and Repair	Tree Trimming	Veg. Control
Section 1 Sediment Controls											
Choose from one or more of the following BMP options when applicable:											
BMP 1-01	Scheduling										
BMP 1-02	Silt Fence										
BMP 1-03	Fiber Rolls										
BMP 1-04	Gravel Bag Berm										
BMP 1-05	Sand Bag Barrier										
BMP 1-06	Storm Drain/Drainage Inlet Protection										
BMP 1-07	Tracking Controls										
BMP 1-08	Stockpile Management										
BMP 1-09	Sediment Basin										
BMP 1-10	Sediment Trap										
BMP 1-11	Check Dam										
BMP 1-12	Active Treatment Systems (ATS)										
Other-User Defined	BMP Description:										
Section 2 Waste Management and Material Controls											
Choose from one or more of the following BMP options when applicable:											
BMP 2-01	Material Delivery and Storage										
BMP 2-02	Material Use										
BMP 2-03	Spill Control										
BMP 2-04	Solid Waste Management										
BMP 2-05	Hazardous Materials/Waste Management										
BMP 2-06	Contaminated Soil Management										
BMP 2-07	Sanitary/Septic Waste Management										
BMP 2-08	Liquid Waste/Drilling Fluid Management										
Other-User Defined	BMP Description:										

BMP SELECTION AND IMPLEMENTATION

**Table 2 (continued)
BMP SELECTION WORKSHEET FOR UTILITY ACTIVITIES**

Utility BMP No.	BMP Options	Construction						Maint. and Repair			
		Overhead Electric	Underground Electric	Potholing	Underground Gas	Boring/Directional Drilling	Pipe Spans	Gen. Maint. and Repair	Inspect and Repair	Tree Trimming	Veg. Control
Section 3 Non-Storm Water Discharge Controls											
Choose from one or more of the following BMP options when applicable:											
BMP 3-01	Dewatering Operations										
BMP 3-02	Paving Operations										
BMP 3-03	Vehicle and Equipment Washing										
BMP 3-04	Vehicle and Equipment Fueling										
BMP 3-05	Concrete/Coring/Saw cutting and Drilling Waste Management										
BMP 3-06	Dewatering Utility Vaults										
BMP 3-07	Over-Water Protection										
BMP 3-08	Paint Removal Control										
BMP 3-09	Temporary Stream Crossing										
BMP 3-10	Clear Water Diversion										
Other-User Defined	BMP Description:										
Section 4 Erosion Control and Soil Stabilization											
Choose from one or more of the following BMP options when applicable:											
BMP 4-01	Preservation of Existing Vegetation										
BMP 4-02	Temporary Soil Stabilization (General)										
BMP 4-03	Hydraulic Mulch										
BMP 4-04	Hydroseeding										
BMP 4-05	Soil Binders										
BMP 4-06	Straw Mulch										
BMP 4-07	Geotextiles, Plastic Covers, and Erosion Control Blankets/Mats										
BMP 4-08	Dust (Wind Erosion) Control										
BMP 4-09	Diversion Berms and Drainage Swales										
BMP 4-10	Velocity Dissipation Devices										
BMP 4-11	Slope Drains										

BMP SELECTION AND IMPLEMENTATION

Table 2 (continued)
BMP SELECTION WORKSHEET FOR UTILITY ACTIVITIES

Utility BMP No.	BMP Options	Construction						Maint. and Repair				
		Overhead Electric	Underground Electric	Potholing	Underground Gas	Boring/Directional Drilling	Pipe Spans	Gen. Maint. and Repair	Inspect and Repair	Tree Trimming	Veg. Control	Other
BMP 4-12	Streambank Stabilization											
BMP 4-13	Soil Preparation											
Other-User Defined	BMP Description:											

BMP DETAILS

The previous section provides details for the selection and implementation of BMPs for the most common utility construction activities. Once the BMP objectives are defined, it is necessary to identify the category or categories of BMPs that are best suited to meet each objective.

A category is a grouping of BMPs related in how they prevent pollution. The four categories are:

- **Section 1 - Sediment Controls**
- **Section 2 - Waste Management and Material Controls**
- **Section 3 - Non-Storm Water Discharge Controls**
- **Section 4 - Erosion Control and Soil Stabilization**

BMP DETAILS 1



Section 1 - Sediment Controls

Why Are Sediment Controls Needed?

Sediment controls are needed to provide a secondary or back-up mechanism to erosion control techniques to prevent sediment discharges from a site. Erosion controls are designed to prevent erosion (the detachment of soil particles from the surface by rain, flowing water or wind), whereas sediment controls are designed to trap soil particles once dislodged by rain, flowing water, or wind. Sediment particles (soil/dust) from construction, operations, and maintenance (construction like) activities can be transported to a different location by wind or water flow. Once these particles have become detached, they can be transported by wind or runoff to water bodies where they can cause damage to aquatic life by burying the animals or plants or reducing oxygen and/or sunlight that is necessary for their survival. Soil particles can also carry other damaging pollutants with them. Displaced sediment from these activities is therefore considered a pollutant by water quality regulatory agencies.

What are Sediment Controls?

Sediment controls include any method that aids in trapping soil particles after they have been detached and moved by wind or water. Sediment controls are usually passive systems that rely on filtering or settling the particles out of the water or wind that is transporting them. The sediment that has accumulated by the BMPs can be redistributed as excess soil on the construction site. Sediment controls are most effective in retaining sediment on site when used in combination with erosion control BMPs. Sediment Controls presented in this Manual include the following:

- BMP 1-01 Scheduling
- BMP 1-02 Silt Fence
- BMP 1-03 Fiber Rolls
- BMP 1-04 Gravel Bag Berm
- BMP 1-05 Sand Bag Barrier
- BMP 1-06 Storm Drain/Drainage Inlet Protection
- BMP 1-07 Tracking Controls
- BMP 1-08 Stockpile Management
- BMP 1-09 Sediment Basin
- BMP 1-10 Sediment Trap
- BMP 1-11 Check Dams
- BMP 1-12 Active Treatment Systems (ATS)



What	Scheduling consists of the planning of soil disturbance activities to avoid periods of rain whenever practical.
When	Scheduling of soil disturbance activities must be considered year-round.
Where	All construction and “construction like” operations and maintenance sites where soil disturbance activities take place.
How	<p>Use the following measures as applicable:</p> <ul style="list-style-type: none">• Consider scheduling major soil disturbing activities or activities near environmentally sensitive areas (e.g., adjacent to water bodies) during prolonged periods when no rain is forecast.• Monitor the weather forecast for seasonable and unseasonable rain events. Obtain weather information from the National Weather Service at<ul style="list-style-type: none">○ www.srh.noaa.gov/• Print and maintain copies of forecasts to document decisions related to inspections and BMP implementation for projects subject to the CGP.• Appropriate sediment controls are required year round. Always be prepared to deploy additional erosion and sediment control and soil stabilization BMPs as needed. Off site sediment discharges can occur because of unseasonable rain, vehicle tracking, unanticipated wind, and non-storm water discharges.• Sequence work to minimize soil-disturbing activities during forecasted rain events.• Limit disturbed soil area to the amount of acreage that can be protected prior to a forecasted rain event.• Stabilize disturbed soil areas as soon as practical, and always prior to a forecasted rain event (See Section 4, Soil Erosion BMPs for soil stabilization methods).• Protect environmentally sensitive areas, such as drainage channels, streams, and natural watercourses.• When rain is forecast, adjust the construction schedule to implement soil stabilization and sediment controls on all disturbed areas prior to the onset of rain.
Maintenance and Inspection	<ul style="list-style-type: none">• Review applicable scheduling and sequencing of construction activities throughout the project or activity to minimize the total area of exposed soil and the exposed soil exposure time.• Inspect erosion and sediment controls prior to and after each storm event, and routinely throughout the construction and/or clean-up activity. If inspections warrant construction BMP changes, amend the schedule accordingly.

Pictures



Corresponding CASQA Fact Sheet

Fact Sheet EC-1

What Silt fences are temporary linear sediment barriers made of permeable fabric that lets water through but prevents the majority of sediment from passing through. Silt fences also act by intercepting and slowing the flow of sediment-laden runoff and allowing sediment to settle from the runoff before water leaves the construction site.

- When**
- Silt fences are designed to intercept sheet flows to moderately concentrated flows.
 - Generally, silt fences shall be used in conjunction with soil stabilization source controls up slope (see Section 4) to provide effective control, particularly for steep slopes, and slopes adjacent to water bodies or Environmentally Sensitive Areas (ESAs).
 - Consider BMP 1-03 “Fiber Rolls” for minor slopes or perimeter sediment control on flat or slightly sloped areas.

- Where** Silt fences are placed:
- Below the toe of exposed and erodible slopes.
 - Down-slope of exposed soil areas.
 - Around temporary stockpiles.
 - Along streams and channels.
 - Along the perimeter of a project.
 - Consider BMP 1-03 “Fiber Rolls” for small stockpiles and perimeters of areas with shallow slopes.

- How**
- Construct silt fences with a setback of at least 3 feet from the toe of a slope in areas suitable for temporary ponding or deposition of sediment. Where a 3-foot setback is not practical, construct as far from the toe of the slope as practical.
 - Construct the length of each reach (length of fence) so that the change in base elevation along the reach does not exceed one-third of the barrier height; each reach should not exceed 500 feet. The last 6 feet of the reach should be turned up slope.
 - The maximum length of slope draining to the silt fence should be 200 feet or less.
 - Excavate a trench approximately 6 inches wide and 6 inches deep to place the bottom of the silt fence into, ensuring that is not wider or deeper than necessary.
 - Key-in, or bury the bottom of silt fence fabric in the trench and tamp into place. If it is not feasible to trench along the slope contour, use sand bags or backfilling to key in the bottom of the fabric.
 - Install fence posts at least 12 inches below grade on the down slope side of trench.
 - **Silt fences should not be used to divert water. Silt fences should not be considered for installation below slopes steeper than 1:1 (vertical: horizontal) or that contain a high number of rocks or loose dirt clods unless the rocks are removed and erosion and soil stabilization controls (Section 4) are used up slope.**
 - Repair or replace split, torn, slumping, undercut or weathered fabric. Note that fabric may need to be replaced when installation is required for more than 5 to 8 months due to limited durability.



**Maintenance
and
Inspection**

Maintenance and Inspection (cont.)

- Inspect silt fences prior to and after each storm event, daily during extended rain events during the construction and/or clean-up activity (e.g., weekly, or in compliance with the frequency specified in the project specific SWPPP, if applicable). Initiate repairs related to a storm event within 72 hours of identifying the problem or as soon as possible but prior to the next predicted storm event, per the CGP.
- Remove accumulated sediment when it reaches one third of the barrier height. Removed sediment shall be incorporated in the project at appropriate locations or disposed of in accordance with federal, state and local requirements.
- Silt fences that are damaged and become unsuitable for the intended purpose shall be removed and disposed of and replaced with new silt fence barriers or other applicable control.
- Remove silt fence when no longer needed and after up-gradient areas are permanently stabilized. Fill and compact post-holes and the anchor trench, remove sediment accumulation, and work the surface of the fence alignment to blend with adjacent ground.

Pictures



Silt fence installed with at least a 3 foot setback from the toe of an erodible slope. Note that use is combined with fiber rolls and serves as perimeter control.

Corresponding CASQA Fact Sheet

Fact Sheet SE-1

What A fiber roll (straw waddle) consists of straw, flax or other similar materials that are rolled and bound into a roll. The fiber roll lets water through but prevents the majority of sediment from passing through. Fiber rolls also act by intercepting and slowing the flow of sediment-laden runoff and allowing sediment to settle from the runoff before water leaves the construction site. In sensitive vegetation areas, only certified weed-free rice straw is to be used.

When Fiber rolls are used for sheet flow or where flows are slightly to moderately concentrated.

Where Fiber rolls are generally placed on the face of slopes at regular slope intervals to intercept runoff, reduce flow velocity, release the runoff as sheet flow and provide sediment removal.

- May be used along the top, face and at grade breaks of exposed and erodible slopes to shorten slope length and spread runoff as sheet flow.
- Fiber rolls are appropriate for perimeter site control or along streams, channels, storm drain inlets, or around stockpiles to intercept sediment-laden storm water and non-storm water runoff.

How Installation

- Locate fiber rolls on level contours spaced in accordance with the CGP requirements for LUP Type 2 & 3 and Risk Level 2 & 3 sites as follows:

Slope Grade	Spacing (sheet flow length not to exceed)
0-25%	20 feet
25-50%	15 feet
Over 50%	10 feet

- In non-paved areas, stake fiber rolls into a trench that is the width of the roll and one-third the depth of the roll (2- to 4-inch deep trench).
- Drive stakes into fiber rolls at a minimum of 4-foot intervals.
- If more than one fiber roll is placed in a row, fiber rolls should be overlapped and not abutted together.

Removal

- When used in a permanent application, fiber rolls can be left in place.
 - Permanent fiber rolls are typically encased with a biodegradable material.
 - Note that removal can result in greater soil disturbance.
- When used for a temporary application as storm drain inlet protection or stockpile control for example, the fiber rolls should be removed at the completion of the construction cleanup activity in that area.
 - Temporary fiber rolls are typically encased with plastic netting that does not biodegrade.
 - Remove fiber rolls only when up gradient areas are stabilized and/or pollutant sources are no longer a hazard.

SEDIMENT CONTROLS

Fiber Rolls (Waddles)

BMP 1-03



How (cont.)

- Remove fiber rolls before vegetation becomes too mature to avoid unnecessary soil and vegetation disturbance.
 - If fiber rolls are removed, collect and dispose of fiber roll and sediment accumulation as appropriate in accordance with federal, state and local requirements. Trapped sediment may be incorporated into the construction site. Fill and compact holes, trenches, depressions, or any other ground disturbance to blend with adjacent ground.
- Note that the cost of disposal of wet fiber rolls may be more expensive than dry fiber rolls.

Maintenance and Inspection

- Repair or replace spilt, torn, unraveling, or slumping fiber rolls.
- Inspect fiber rolls if rain is forecasted and perform maintenance as needed.
- Inspect fiber rolls prior to and after each rain event, and daily during extended rain events throughout the construction and/or clean-up activity (e.g., weekly, or in compliance with the frequency specified in the project specific SWPPP, if applicable). Initiate repairs related to a storm event within 72 hours of identifying the problem or as soon as possible but prior to the next predicted storm event, per the CGP.
- Do not use fiber rolls containing polyacrylamide or other flocculants. Use is considered "active treatment" and is subject to ATS requirements of the CGP (see BMP Detail 1-12).

Pictures

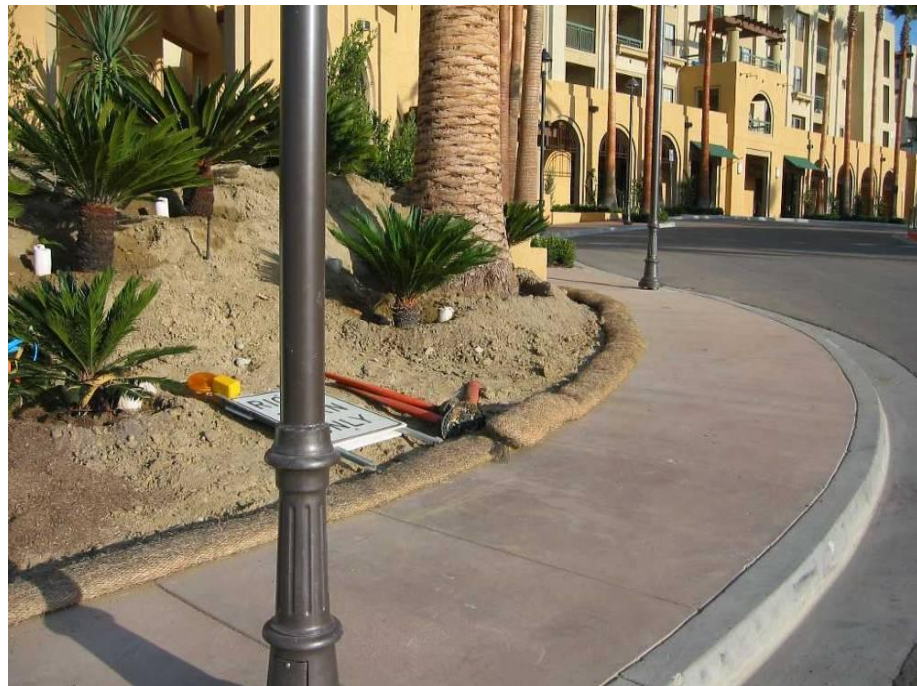

Fiber rolls as perimeter control.

**Pictures
(cont.)**



Fiber roll installation on the face of a slope.

**Corresponding
CASQA
Fact Sheet**

Fact Sheet SE-5



What	A gravel bag berm consists of at least a single row of gravel bags that are installed end-to-end to form a barrier across a slope to intercept runoff.
When	Use gravel bag berms: <ul style="list-style-type: none">• When needed to reduce storm water flow velocity, release the runoff as sheet flow, and provide some sediment removal.• Gravel bag berms can also be used when flows are moderately concentrated and when it is desirable to filter sediment in runoff. Gravel bag berms are generally more permeable than sand bags.
Where	<ul style="list-style-type: none">• Ditches, swales, and storm drain inlets• Gravel bag berms are also appropriate for perimeter site control or along streams, channels, storm drain inlets, or around stockpiles to intercept sediment laden storm water and non-storm water runoff.• Along the face and at grade breaks of exposed and erodible slopes to shorten slope length and spread runoff as sheet flow.• Gravel bags may be implemented with other BMPs to maximize sediment containment.• Sand bag barriers should be used in cases where it is desirable to block and pond flows (BMP 1-05 "Sand Bag Barrier").
How	<ul style="list-style-type: none">• When used as a linear control for sediment removal:<ul style="list-style-type: none">○ Install along a level contour.○ Turn ends of gravel bag row up slope to prevent flow around the ends.○ Generally, gravel bag barriers are used in conjunction with temporary soil stabilization controls up slope to provide effective control.• When used for concentrated flows:<ul style="list-style-type: none">○ Stack gravel bags to required height. When the height requires 3 rows or more, use a pyramid approach.○ Upper rows of gravel bags shall overlap joints in lower rows.• Construct gravel bag barriers with a setback of at least 3 feet from the toe of a slope. Where a 3-foot setback is not practical, construct as far from the toe of the slope as practical.
Maintenance and Inspection	<ul style="list-style-type: none">• Perform routine inspections of gravel bag berms prior to and after each storm event, and daily during extended rain events throughout the construction and/or clean-up activity (e.g., weekly, or in compliance with the frequency specified in the project specific SWPPP, if applicable). Initiate repairs related to a storm event within 72 hours of identifying the problem or as soon as possible but prior to the next predicted storm event, per the CGP.• Reshape or replace gravel bags as needed.• Repair washouts or other damage as needed. Note that bags may need to be replaced when installation is required for more than 6 months due to limited durability.• Inspect gravel bag berms for sediment accumulations and remove sediment when accumulation reaches one-third of the berm height. Removed sediment shall be incorporated in the project at appropriate locations or disposed of in accordance with federal, state and local requirements.

SEDIMENT CONTROLS

Gravel Bag Berm

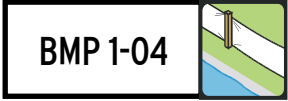

Maintenance and Inspection (cont.) Pictures

- Remove gravel bag berms when no longer needed and when feasible, recycle gravel fill. Remove sediment accumulation, and clean, re-shape, and stabilize the area. Removed sediment shall be incorporated in the project at appropriate locations or disposed of in accordance with federal, state and local requirements.



Gravel bags and fiber rolls used as perimeter sediment controls.



Gravel bags used as perimeter control.

Corresponding CASQA Fact Sheet

Fact Sheet SE-6



- What** A sand bag barrier is a temporary linear sediment barrier consisting of at least one row high of sand bags placed end-to-end, designed to intercept and slow sediment-laden storm water and non-storm water runoff. Sand bag barriers allow sediment to settle from runoff before water leaves the construction site. Sand bag barriers tend to block and pond storm water flows.
- When**
- During construction or operation and maintenance activities in streambeds when the contributing drainage area is small.
 - To capture and detain non-storm water flows.
 - When site conditions or activity sequencing require adjustments or relocation of the barrier to meet changing field conditions and needs during construction.
 - To temporarily close or continue broken, damaged or incomplete curbs.
- Where** Sand bag barriers are used:
- To divert or direct flow away from disturbed slopes or create a temporary sediment basin.
 - Where flows are moderately concentrated, such as ditches, swales, and storm drain inlets to divert and/or detain flows.
 - Along the perimeter of a site, vehicle and equipment fueling and maintenance areas, chemical storage areas, or stockpiles.
 - Below the toe or down slope of exposed and erodible slopes.
 - Parallel to streams, channels, and roadways.
 - Across channels to serve as a barrier for utility trenches or provide a temporary channel crossing for construction equipment, or to reduce stream impacts.
 - Caution - do not use sand bag barriers in traffic areas or other areas where potential flooding is possible. Consider use of BMP 1-03 "Fiber Rolls" or BMP 1-04 "Gravel Bag Berms."
- How**
- When used as a linear control for sediment removal:
 - Install along a level contour.
 - Turn ends of sand bag row up slope to prevent flow around the ends.
 - Generally, sand bag barriers shall be used in conjunction with temporary soil stabilization controls up slope to provide effective control.
 - When used for concentrated flows:
 - Stack sand bags to required height. When the required height is three rows or more, use a pyramid approach. Upper rows of sand bags shall overlap joints in lower rows.
 - Construct sand bag barriers with a setback of at least 3 feet from the toe of a slope. Where a 3-foot setback is not practical, construct as far from the toe of the slope as practical.

SEDIMENT CONTROLS

Sand Bag Barrier



Maintenance and Inspection

- Perform routine inspections of sand bag barriers prior to and after each storm event, and daily during extended rain events throughout the construction and/or clean-up activity (e.g., weekly, or in compliance with the frequency specified in the project specific SWPPP, if applicable). Initiate repairs related to a storm event within 72 hours of identifying the problem or as soon as possible but prior to the next predicted storm event, per the CGP. Repair washouts or other damages as needed.
- Note that bags may need to be replaced when installation is required for more than 6 months due to limited durability.
- Inspect sand bag barriers for sediment accumulations and remove sediments when accumulation reaches one-third the barrier height.
- Remove sand bags when no longer needed and when feasible, recycle fill. Remove sediment accumulation, and clean, re-grade, and stabilize the area. Incorporate removed sediment at appropriate project locations or disposed of in accordance with federal, state and local requirements.

Pictures



Sand bags used as perimeter control.

Corresponding CASQA Fact Sheet

Fact Sheet SE-8



What	A BMP or a combination of BMPs used at storm drains or other drainage inlets to protect against the discharge of sediment-laden storm water and non-storm water runoff from construction or operational and maintenance activities. The BMP slows or ponds the storm water flow, giving the sediment time to settle out before discharge to the storm drain.
When	This BMP is required on all construction projects and operation and maintenance sites when sediment laden surface runoff may enter a storm drain inlet and/or drainage to watercourses. Do not construct when runoff will result in ponding into road traffic or onto erodible surfaces or slopes, or overflow onto the sidewalk.
Where	At downstream storm drain and/or drainage inlets that have the potential to be impacted by construction or “construction like” operation and maintenance activity, site storm water run-off, or non-storm water discharges.
How	<ul style="list-style-type: none">• Identify all downstream storm drain inlets or drainages that have the potential to receive runoff or non-storm water discharges from construction activities.• Where a storm drain or drainage inlet is on or at the bottom of a slope, a series of small check dams (i.e., gravel bag berms) constructed at intervals along the slope may be required to slow the runoff. See BMP 1-11.• Select appropriate protection and construct inlet protection based on the configuration of inlets at the site.• Some municipalities require removal of BMPs from storm drains within 72 hours of a rain event (e.g., City of San Diego requires removal of inlet protection in the case that 0.25 inch or greater of rain is predicted). Consult with your project Field Environmental Representative for local requirements.• Remove inlet protection devices at the end of the construction period, or when the inlet can no longer be impacted by the project or activity.
Maintenance and Inspection	<ul style="list-style-type: none">• Perform routine inspections of BMPs prior to and after storm event, and daily during extended rain events throughout the construction and/or clean-up activity (e.g., weekly, or in compliance with the frequency specified in the project specific SWPPP, if applicable). Initiate repairs related to a storm event within 72 hours of identifying the problem or as soon as possible but prior to the next predicted storm event, per the CGP.• During inspections:<ul style="list-style-type: none">○ Inspect bags, silt fence, or filter fabric for holes, gashes, and snags.○ Check gravel bags for proper arrangement and displacement.○ Remove the sediment behind the barrier when it reaches one-third of the barrier height. Removed sediment should be incorporated in the project or disposed of in accordance with federal, state and local requirements.

Pictures

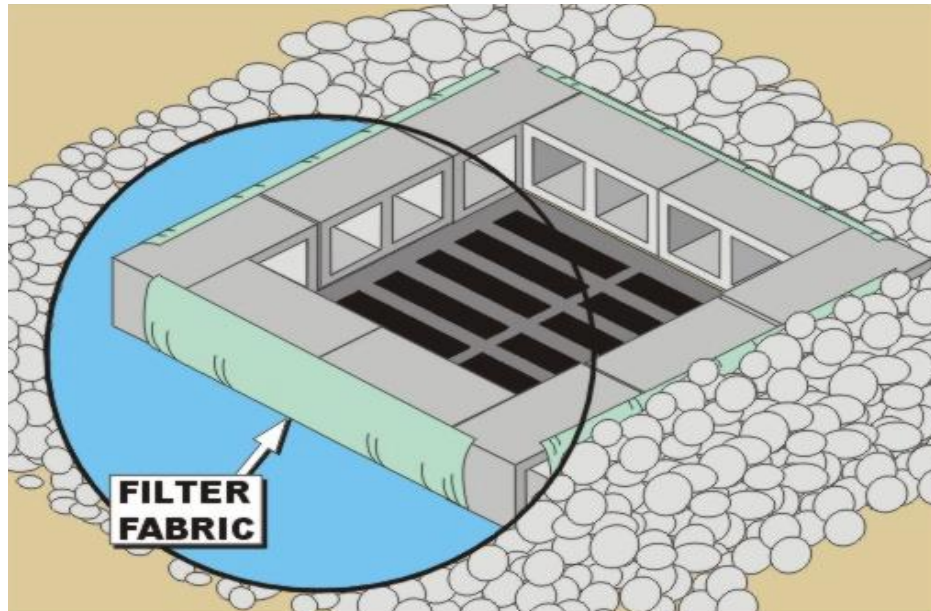

Block and gravel-type inlet protection.



Inlet protection that blocks flow, preventing non-storm water discharges from entering drain.

SEDIMENT CONTROLS

Storm Drain/Drainage Inlet Protection

BMP 1-06 

Pictures (cont.)



Gravel bag inlet protection.



Inlet protection using fiber rolls and filter fabric.

Corresponding CASQA Fact Sheet

Fact Sheet SE-10



- What** Tracking controls consist of constructed/manufactured steel plates (rumble plates) or gravel. Tracking controls reduce offsite tracking of sediment and other pollutants by providing a stabilized entrance at defined soil disturbance activity site entrances and exits with materials that aid in removing sediment from vehicles, especially their tires or tracks. Controls can also consist of providing methods to clean-up sediment or other materials to prevent them from entering a storm drain, such as sweeping or vacuuming. Tracking controls can also include implementing tire washing.
- When**
- Stabilized entrances/exits should be implemented on each soil disturbance site having a defined entrance/exit consisting of soil which terminates into a paved roadway or substantial paved surface. Stabilized entrances/exits are in addition to other applicable BMPs.
 - Daily sweeping or vacuuming should be implemented when sediment is tracked from the site onto public or private paved roads, typically at points of site exit.
 - Install and implement tire washing when the above methods are not adequately controlling track-out.
- Where** Use stabilized entrances and/or sweeping (and tire washing, if needed) at construction and “construction like” operations and maintenance activity sites:
- where dirt or mud is tracked onto public roads;
 - adjacent to water bodies;
 - where poor soils are encountered, such as soils containing clay; and
 - where dust is a problem during dry weather conditions.
- How**
- Stabilized Entrances
- Limit the points of entrance/exit to the construction or operations and maintenance site by designating combination or single purpose entrances and exits. Require all employees, subcontractors and others to use them. Limit speed of vehicles to control dust.
 - Where feasible, grade each construction entrance/exit to prevent runoff from leaving the construction site.
 - Route runoff from stabilized entrances/exits through a sediment-trapping device before discharge (see BMP 1-10).
 - Design stabilized entrance/exit to support heaviest vehicles and equipment.
 - Select construction access stabilization (aggregate, asphaltic concrete, concrete) based on longevity, required performance, and site conditions.
 - Use of constructed or constructed/manufactured steel plates with ribs for entrance/exit access is allowed.
 - If aggregate is selected, place crushed aggregate over geotextile fabric to at least 12 inches deep, or place aggregate to a depth recommended by a geotechnical engineer. A crushed aggregate greater than 3 inches but smaller than 6 inches shall be used.
- Street Sweeping and Vacuuming
- Inspect potential sediment tracking locations routinely.
 - Visible sediment tracking should be swept or vacuumed as needed. Manual sweeping is appropriate for small jobs.

How



- (cont.)**
- For larger projects, it is preferred to use mechanical sweeping methods that collect removed sediment and material.
 - If not mixed with debris or trash, incorporate the removed sediment back into the project or dispose of in accordance with federal, state and local requirements.
- Tire Washing
- Design wash rack to support the heaviest traffic loads.
 - Provide a turnout or doublewide exit to avoid traffic from entering through the tire washing area.
 - Design a drainage ditch to route all rinse or wash waters from the tire washing area to a sediment trapping device (see BMP 1-10) to prevent any wash runoff from leaving the site.
 - Hoses should be equipped with automatic shutoff nozzles.
- Maintenance and Inspection**
- Stabilized Entrances
- Inspect routinely for damage and assess effectiveness. Remove sediment and repair if the stabilized entrance/exit is clogged with sediment.
 - Perform routine inspections of BMPs, prior to and after storm events, and daily during extended rain events throughout the construction and/or clean-up activity (e.g., weekly, or in compliance with the frequency specified in the CGP, if applicable). Initiate repairs related to a storm event within 72 hours of identifying the problem or as soon as possible but prior to the next predicted storm event, per the CGP.
 - Where tracking has occurred on roadways, sweeping should be conducted the same day. Water should not be used to wash sediment off the streets, unless necessary. If water is used, it must be captured, preventing sediment-laden water from running off the street or site.
 - Keep all temporary roadway ditches clear.
- Street Sweeping and Vacuuming
- Inspect silt fences prior to and after each storm event, daily during extended rain events during the construction and/or clean-up activity (e.g., weekly, or in compliance with the frequency specified in the project specific SWPPP, if applicable). Initiate repairs related to a storm event within 72 hours of identifying the problem or as soon as possible but prior to the next predicted storm event, per the CGP.
 - Inspect all site paved access roads daily and remove any sediment or other materials on the roads by vacuuming or sweeping daily, as needed, and prior to any rain event in accordance with the CGP Risk Levels 2 & 3 requirements.
 - Be careful not to sweep up any unknown substance or any object that may be potentially hazardous.
 - After sweeping is finished, properly dispose of sweeper wastes.
- Tire Washing
- Inspect BMPs prior to and after each storm event, daily during extended rain events during the construction and/or clean-up activity (e.g., weekly, or in compliance with the frequency specified in the project specific SWPPP, if applicable). Initiate repairs related to a storm event within 72 hours of identifying the problem or as soon as possible but prior to the next predicted storm event, per the CGP.
 - Inspect rack and/or sediment trap system routinely for damage and assess effectiveness. Remove accumulated sediment to maintain system

performance.

Pictures



Manufactured metal plates knock dirt off vehicle tires before exiting a site.



Drive through wheel wash before exiting a site.

**Corresponding
CASQA
Fact Sheet**

Fact Sheets TC-1, TC-2, TC-3, and SE-7



- What** Stockpile management consists of placing temporary BMPs, such as secured covers, over the piles, and/or placing berms, silt fences, fiber rolls, sand/gravel bags or straw bale barriers around the perimeter of stockpiles. Soil stabilizers/binders may also be used to augment stockpile management (BMP 4-05).
- When** Use this BMP when construction projects or operation and maintenance activities require stockpiled soil, waste materials, and/or paving materials. Protection of stockpiles must be implemented whenever there is a potential for transport of materials by a water source or by wind.
- Construction and waste material stockpiles require protection from rain and wind at all times unless actively being used (protect during non-activity). Projects with SWPPPs require protection at the end of each day.
- Where** Stockpiles at construction and “construction like” operation and maintenance activity sites, protecting against both run-on and run-off.
- How** One or more of the following options may be used to manage stockpiles and prevent stockpile erosion and sediment discharges for storm water and non-storm water runoff/run-on.
- Stockpile may be returned to the excavation if precipitation is forecast.
 - Sufficient BMP materials for temporary stockpile protection should be available onsite. Select cover materials or methods based on anticipated duration.
 - Protect stockpiles from storm water run-on and sediment runoff from the stockpiles using a temporary perimeter sediment barrier such as berms, silt fences, fiber rolls, sand/gravel bags, or straw bale barriers, as appropriate.
 - Cover stockpiles to prevent erosion. Note that the CGP requires that inactive stockpiles be covered. Where feasible, cover/protect stockpiles using a soil binder, according to BMP 4-05. Alternately, secure stockpiles with covers such as Visqueen weighted down with gravel bags, or sand bags. Plastic should be properly re-used or disposed of properly. Note the CGP discourages the use of plastic materials for cover when more sustainable alternatives can be used.
 - Stockpiles may be hauled off or temporarily stored in a protected location off site.
- Keep stockpiles organized and surrounding areas clean.
 - Protect storm drain inlets, watercourses, and water bodies from stockpiles, as appropriate.
 - Implement dust control practices as appropriate on all stockpiled material.
 - **Stockpiles should be covered, stabilized, or protected prior to the onset of precipitation.**
 - Repair and/or replace covers, and perimeter containment structures as needed.
 - Inspect BMPs prior to and after each storm event, daily during extended rain events during the construction and/or clean-up activity (e.g., weekly, or in compliance with the frequency specified in the project specific SWPPP, if applicable). Initiate repairs related to a storm event within 72 hours of identifying the problem or as soon as possible but prior to the next predicted storm event, per the CGP.



Maintenance and Inspection

Pictures



Stockpile covered with plastic and secured with large rocks.



Silt fence used for stockpile perimeter control.

**Corresponding
CASQA
Fact Sheet**

Fact Sheet WM-3



- What** Sediment basins are temporary basins formed by excavation or by constructing an embankment to temporarily detain sediment-laden runoff, allowing sediment to settle out before water leaves the site. The CGP specifies that sediment basins be designed per the CASQA fact sheet SE-2, therefore, this BMP provides general guidance and the CASQA handbook reference.
- When** Sediment basins are appropriate:
- If sediment-laden water may enter a drainage system or watercourse.
 - If areas are disturbed during the rainy season, in association with dikes, temporary channels, and pipes to convey runoff from disturbed areas.
 - To construct before land disturbance, when feasible.
 - In conjunction with erosion controls.
- Where** Sediment basins are suitable on larger projects with sufficient space for the basin, and should be considered:
- Where maintenance is possible year-round.
 - Within property limits, and where failure will not result in loss of life, building damage, or interruption of public roads or utilities.
 - At the outlet of disturbed areas draining generally between 5 and 75 acres, evaluated on a site-specific basis.
 - Where post-construction detention basins are required.
- How** Design the sedimentation basin in accordance with CASQA fact sheet SE-2.
- In general, the basin depth must be no less than 3 feet, not including freeboard, which includes a sediment storage zone and a settling zone of at least 1 and 2 feet deep, respectively.
 - Include features to accommodate overflow or bypass flows that exceed the design storm event.
 - Utilize rock, vegetation, or other erosion control measures to protect the basin inlet, outlet, and slopes against erosion.
 - Continuous fencing should be provided around the sedimentation basin to prevent unauthorized entry.



Maintenance and Inspection

- Inspect BMPs prior to and after each storm event, daily during extended rain events during the construction and/or clean-up activity (e.g., weekly, or in compliance with the frequency specified in the project specific SWPPP, if applicable). Initiate repairs related to a storm event within 72 hours of identifying the problem or as soon as possible but prior to the next predicted storm event, per the CGP.
- Inspect basin banks for seepage and structural soundness.
- Check inlet and outlet structures, spillway, and fencing for damage or obstructions. Repair damage and remove obstructions as needed.
- Remove accumulated sediment when it reaches 1/2 of the basin height or in accordance with the SWPPP requirements. Removed sediment shall be incorporated into the project appropriately or disposed of in accordance with federal, state and local requirements.
- Remove accumulation of any vegetation during every inspection.
- Remove standing water from the basin within 72 hours after accumulation to prevent the production of mosquitoes.
- Completely remove basin when no longer needed. Remove sediment accumulation. Fill and compact excavation, any fencing post-holes and anchor trench, and blend the surface with the adjacent ground.

Pictures

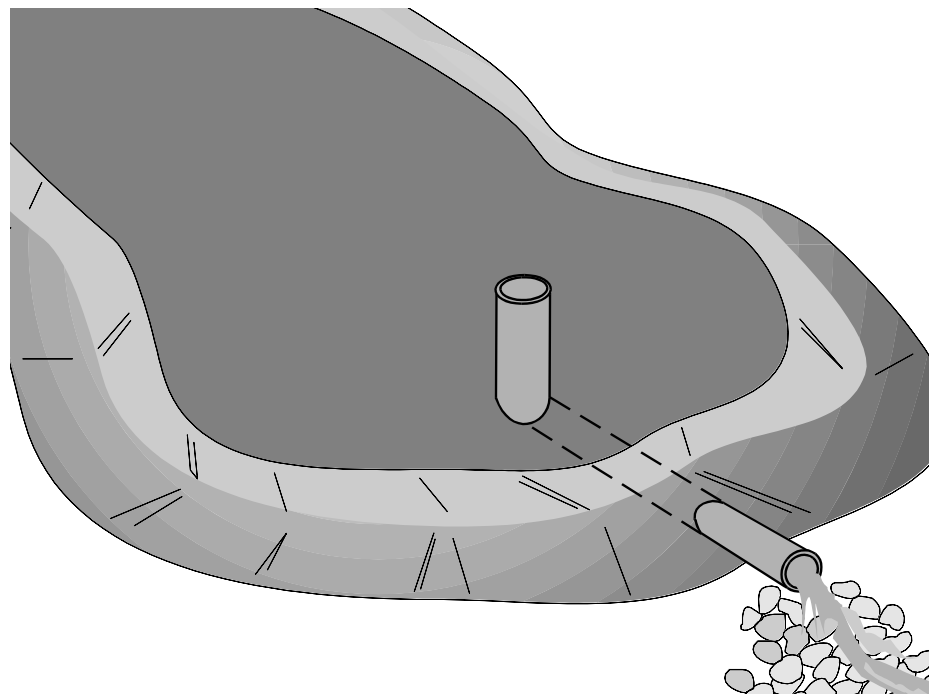

Corresponding CASQA Fact Sheet

Fact Sheet SE-2



What Sediment traps are small, temporary containment areas where sediment-laden runoff is detained, allowing sediment to settle from the runoff before water leaves the site. Sediment traps are formed by excavating or constructing an earthen embankment across a waterway or low drainage area, and usually have a gravel outlet. Sediment traps only remove large and medium-sized soil particles and require upstream erosion control.

When Sediment traps are appropriate:

- If the drainage area is less than 5 acres.
- If sediment-laden water may enter a drainage system or watercourse.
- Construction or operation and maintenance activity occurs in small drainage areas with no unusual drainage features, and short-duration construction activities.
- To construct before land disturbance, when feasible.
- In conjunction with upstream erosion controls.

Where Sediment traps are suitable on sites with sufficient space to allow for infiltration and sediment settling, and should be considered:

- Outside the area being graded, but as near as practical to sediment producing areas, with access for maintenance.
- At the perimeter of a site, at one or more locations where sediment-laden runoff is discharged offsite, to a storm drain or watercourse.
- Around or upslope from storm drain inlet protection measures.
- Within property limits and where failure will not result in loss of life, building damage, or interruption of public roads or utilities.
- **Should not be located in streams unless properly permitted with regulatory agencies. Consult with the Field Environmental Representative.**



How

- Design the sediment trap per referenced engineering standards or local grading ordinance.
- Trap side slopes should be 1:3 (vertical: horizontal) or flatter.
- Trap should be sized to accommodate a settling zone and sediment storage zone with recommended minimum volumes of 67 yd³/acre and 33 yd³/acre of contributing drainage area, respectively, based on 0.5 inch of runoff volume over 24 hours. Larger or multiple traps may be required to accommodate specific rainfall, soil, or site conditions.
- Traps with an impounding levee greater than 4.5 feet tall, measured from the lowest point of the impounding to the highest point of the levee, and traps capable of impounding more than 35,000 ft³, should be designed by a California Registered Civil Engineer.
- The outlet pipe or open spillway must be designed to convey anticipated peak flows.
- When an earth or stone outlet is used, the outlet crest elevation should be at least 1 foot below the top of embankment.
- When a crushed stone outlet is used, the crushed stone or gravel should meet AASHTO M43, size No. 2 or 24, or its equivalent.



- | | |
|---|--|
| How
(cont.) | <ul style="list-style-type: none">• Clear any vegetation under the embankment and pool area.• The compacted embankment fill material must be free of roots, vegetation, oversize, or other objectionable material.• When a riser is used, all pipe joints must be watertight, and at least the top 2/3 of the riser should be perforated with 0.5-inch diameter holes spaced 8 inches vertically and 10 to 12 inches horizontally.• Utilize rock, vegetation, or other erosion control measures to protect the trap outlets against erosion.• Fencing should be provided around the trap to prevent unauthorized entry. |
| Maintenance
and
Inspection | <ul style="list-style-type: none">• Inspect BMPs prior to and after each storm event, daily during extended rain events during the construction and/or clean-up activity (e.g., weekly, or in compliance with the frequency specified in the project specific SWPPP, if applicable). Initiate repairs related to a storm event within 72 hours of identifying the problem or as soon as possible but prior to the next predicted storm event, per the CGP.• Inspect trap banks for seepage and structural soundness.• Inspect outlet structures, spillway, and fencing for any erosion, damage, or obstructions. Repair damage and remove obstructions as needed.• Remove accumulated sediment when it reaches one third of the trap capacity. Removed sediment shall be incorporated in the project appropriately or disposed of in accordance with federal, state and local requirements.• Remove accumulation of any vegetation during every inspection.• Water suitable for mosquito production may stand in the sediment trap, particularly if subjected to daily non-storm water flows. Remove standing water from the trap 72 hours after accumulation.• Remove trap when no longer needed. Remove sediment accumulation, fill and compact excavation, any fencing post-holes, and blend the surface with adjacent ground.• BMPs that require dewatering shall be continuously attended during dewatering. Dewatering BMPs shall be implemented at all times during such activities. |

Pictures

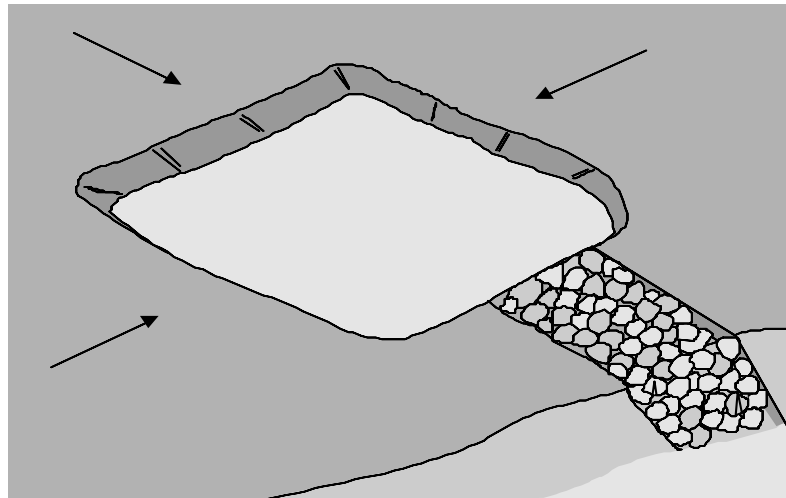

**Corresponding
CASQA
Fact Sheet**

Fact Sheet SE-3



What Check dams are small barriers constructed of rock, logs, gravel bags, sandbags, fiber rolls, or other suitable materials, placed across a swale or drainage ditch. Check dams create small pools and reduce the effective slope of the channel, reducing scour and erosion by reducing flow velocity and increasing residence time within the channel. Check dams promote sediment trapping.

When Check dams are appropriate:

- If sedimentation should be promoted behind the dam.
- If erosion protection is desired in small intermittent channels and temporary swales.
- During the establishment of grass linings in drainage ditches or channels.
- If grade control is desired or required.

Where Check dams should be considered:

- In small open channels that drain 10 acres or less.
- In channels to reduce slope and storm water runoff velocities.
- In temporary ditches where the short length of service does not warrant establishment of erosion-resistant lining.



Check dams should not be used:

- **In streams or in channels with flow between storm events.**
- In channels that are already grass-lined, unless erosion potential or sediment-laden flow is expected. Installation of check dams may damage vegetation.

How

- Do not construct check dams with straw bales or silt fence, since concentrated flows quickly wash out these materials.
- Check dams reduce the capacity of the ditch or swale. Alternative BMPs or an increased swale or ditch size may be necessary or the size of the ditch or swale may need to be increased to prevent overtopping.
- Maximum slope and velocity reduction is achieved when the toe of the upstream dam is at the same elevation as the top of the downstream dam. The center section of the dam should be lower than the edge sections (at least 6 inches), acting as a spillway, so that the check dam will direct flows to the center of the ditch or swale.
- The check dam should be installed along a level contour and should completely span the ditch or swale to prevent washout.
- Install the first check dam approximately 16 feet from the outfall device and at regular intervals based on slope gradient and type.
- Check dams should be placed at a distance and height to allow small pools to form between each check dam.
- For multiple check dam installation, backwater from a downstream check dam should reach the toe of the upstream check dam.
- High flows (typically a 2-year storm or larger) should safely flow over the check dam without an increase in upstream flooding or damage to the check dam.



How (cont.)

- Rock check dams are usually constructed of 8 to 12 inch rock placed individually by hand or mechanically, but never dumped. The rock used should be large enough to stay in place given the expected channel flow. Abutments should be extended 18 inches into the channel bank. Rock can be graded such that smaller diameter rock (2 to 4 inches) is located on the upstream side of larger rock, increasing residence time.
- Log check dams are usually constructed of 4 to 6 inch diameter logs installed vertically, and embedded at least 18 inches into the soil, and can be bolted or wired.
- See BMP 1-03 for installation of fiber roll check dams. Fiber rolls should be trenched in, backfilled, and firmly staked.
- Gravel bag and sand bag check dams are constructed by stacking bags across the ditch or swale. Gravel bags and sand bags used to construct check dams should conform to the requirements of BMP 1-04 and 1-05, respectively. Tightly abut bags and stack in a pyramid fashion no higher than 3 feet. Upper rows shall overlap joints in lower rows.
- Manufactured products used to construct check dams should be installed in accordance with the manufacturer's instructions, and typically requires trenching or anchoring.
- If grass is planted to stabilize the ditch or swale, the check dam should be removed when the grass has matured, unless the slope of the swale is greater than 4 percent.

Maintenance and Inspection

- Check dams require extensive maintenance following high-velocity flows.
- Inspect BMPs prior to and after each storm event, daily during extended rain events during the construction and/or clean-up activity (e.g., weekly, or in compliance with the frequency specified in the project specific SWPPP, if applicable). Initiate repairs related to a storm event within 72 hours of identifying the problem or as soon as possible but prior to the next predicted storm event, per the CGP.
- Replace missing, damaged, or degraded rock, bags, rolls, etc.
- If the check dam is used as a grade control structure, sediment removal is not required as long as the system continues to control the grade.
- Sediment can be re-suspended during subsequent storms or removal of the check dam. Remove accumulated sediment when it reaches 1/3 of the barrier height, and prior to permanent seeding or soil stabilization. Removed sediment shall be incorporated in the project at appropriate locations or disposed of in accordance with federal, state and local requirements.
- Water suitable for mosquito production may stand behind check dams, particularly if subjected to daily non-storm water flows. Remove standing water from the dam 72 hours after accumulation.
- Remove check dam and accumulated sediment when no longer needed.

Pictures

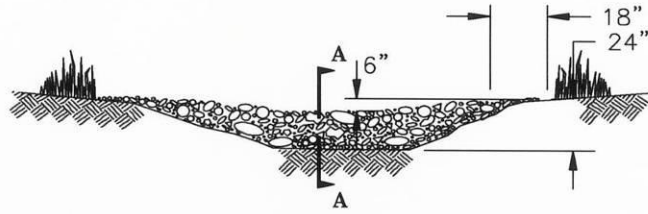

VIEW LOOKING UPSTREAM

NOTE:
 KEY STONE INTO THE DITCH BANKS
 AND EXTEND IT BEYOND THE ABUTMENTS
 A MINIMUM OF 18" TO PREVENT OVER
 FLOW AROUND DAM.

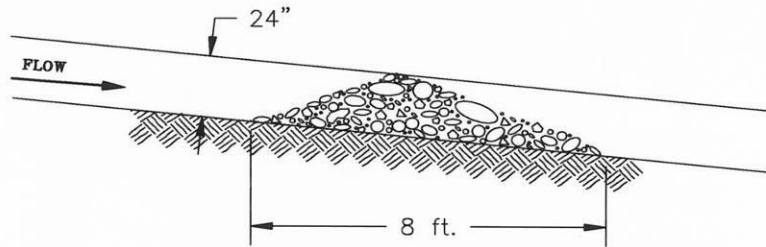

SECTION A - A

'L' = THE DISTANCE SUCH THAT POINTS 'A' AND
 'B' ARE OF EQUAL ELEVATION.

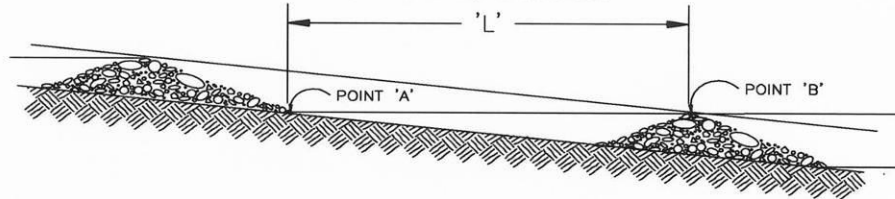

SPACING BETWEEN CHECK DAMS

**Corresponding
 CASQA
 Fact Sheet**

Fact Sheet SE-4



What Active Treatment Systems (ATS) reduce turbidity of runoff by introducing chemicals to storm water through direct dosing or an electrical current to enhance flocculation, coagulation, and sediment settling. Coagulants and flocculants include inorganic salts and polymers which enhance sediment settling and removal and reduce turbidity. The CGP has specific requirements for ATS. Only general guidance for ATS is provided in this BMP; additional details are provided in the CASQA Handbook.

Limitations:



- **Specific permit requirements or mitigation measures such as RWQCB 401 Certification, U.S. Army Corps of Engineers 404 permit, and approval by the California Department of Fish and Game supersede the guidance in this BMP.**
- If numerical water quality standards are mentioned in any permits, testing and sampling may be required. Streams listed as 303(d) impaired for sediment, silt, or turbidity, are required to conduct sampling to verify that there is no net increase in sediment load due to construction activities.

When ATS should be used when a rigorous combination of drainage control, erosion control, and sediment control BMPs are not effective or are not anticipated to be effective based on site soil types (e.g., fine grained or highly erosive soils), proximity to sediment-sensitive receiving waters, and/or other site constraints. Phasing and limiting active areas of disturbance should be considered prior to use of an ATS.

Where ATS should be considered where turbid discharges to sediment and turbidity sensitive waters cannot be avoided using traditional BMPs.

How



- **ATS should be implemented in accordance with the guidance provided in the CASQA Handbook.**
- **Dischargers choosing to utilize chemical treatment in ATS must also follow all guidelines of the CGP Attachment F - Active Treatment System Requirements.**

Maintenance and Inspection

- ATS must be operated and maintained by experienced personnel meeting CGP training requirements at all times during treatment operations. Visual monitoring for proper performance shall be performed daily and recorded in a data log. The project data log shall include the name, phone number, and training documentation of the person responsible for operating and monitoring ATS.
- Requirements for ATS shall include but are not limited to operational and compliance monitoring, toxicity monitoring for batch and flow-through treatments, numeric effluent limit compliance, operator training, implementation of standard BMPs, and proper sediment removal and disposal.

Pictures

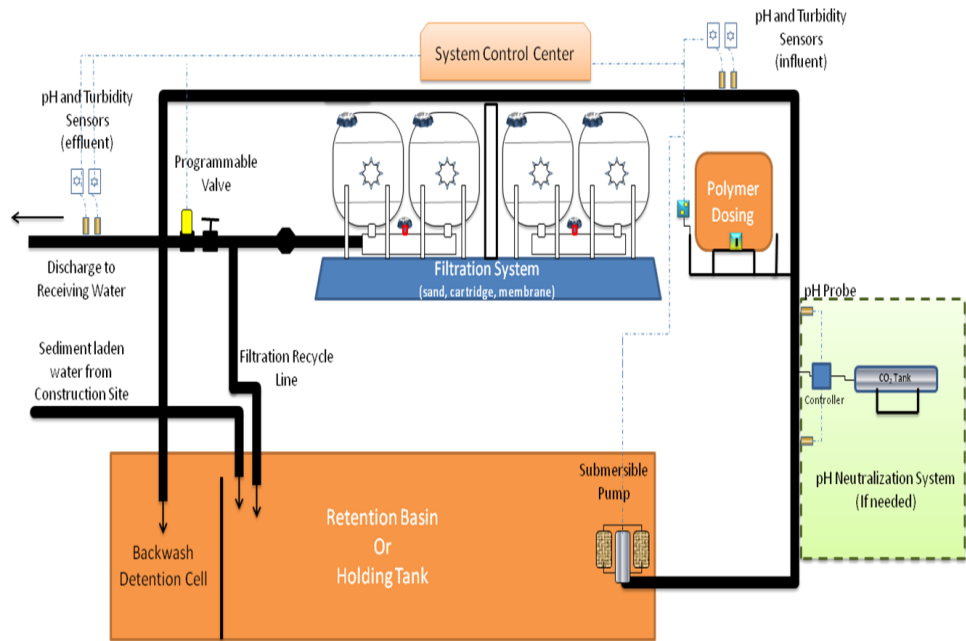

Figure has been adapted from Port of Seattle response to Washington Dept. of Ecology Action Order 2948

**Corresponding
CASQA
Fact Sheet**

Fact Sheet SE-11

BMP DETAILS 2



Section 2 - Waste Management and Material Controls

Why Are Waste Management and Material Controls Required?

Federal, state and local laws, regulations, ordinances and permits prohibit the discharge of contaminated storm water to storm drains, drainages, and surface waters. Pollutants such as litter, paint, solvents, fuel, lubricants and demolition wastes, can be transported by runoff from a construction site. These BMPs address pollutants associated with material use and waste management to ensure that all pollutants are properly managed and are not discharged to storm drains, drainages, and surface waters.

What are Waste Management and Material Controls?

Waste Management and Materials Controls are source control BMPs that reduce or prevent contact between wastes and/or materials and storm water. Waste Management and Materials Controls presented in this Manual include the following:

- BMP 2-01 Material Delivery and Storage
- BMP 2-02 Material Use
- BMP 2-03 Spill Control
- BMP 2-04 Solid Waste Management
- BMP 2-05 Hazardous Materials/Waste Management
- BMP 2-06 Contaminated Soil Management
- BMP 2-07 Sanitary/Septic Waste Management
- BMP 2-08 Liquid Waste/Drilling Fluid Management



What	Material Delivery and Storage Controls are procedural BMPs controlling the delivery and storage of construction materials, supplies and wastes so that storm water run-on and run-off and non-storm water discharges do not contact the material or wastes.
When	This BMP is applicable when it is necessary to store materials at a construction or operations and maintenance site, and does not apply to materials and supplies stored on trucks that are driven on site and off site daily.
Where	All construction or operations and maintenance activity sites where construction material is delivered or stored and has the potential to be contacted by storm water.
How	Use the following BMP measures as appropriate: <ul style="list-style-type: none">• Only store the minimum amount of material that is needed for the job.• Locate storage areas away from storm drain inlets, drainage systems, and watercourses to prevent storm water run-on from reaching the materials.• If practical, store materials in enclosed storage containers such as cargo containers.• Store materials on impervious surfaces or use plastic groundcovers and berms on bare soil to prevent spills or leakage from contaminating the ground.• For known hazardous materials, keep materials covered using plastic or other waterproof materials.• Store chemicals in water tight containers with appropriate secondary containment systems or in a storage shed to prevent contaminated run-off/run-on from leaving storage areas.• Keep an adequate supply of spill kit materials nearby.• Ensure that qualified personnel are available when hazardous materials are delivered to ensure proper delivery and storage in a designated area.• Material Safety Data Sheets (MSDS) should be made available on-site for all materials stored that have the potential to come in contact with storm water.• When a storage area is no longer needed, return it to original condition.• Bagged materials such as cold patch, concrete mix, and other materials with the potential to pollute runoff should be placed on pallets and covered during non-working days and prior to and during rain events.
Maintenance and Inspection	<ul style="list-style-type: none">• Repair or replace covers, containment structures, or perimeter controls as needed to ensure proper function.• Perform Routine BMP inspections of labels on containers and designated delivery and storage areas.• Inspect BMPs prior to and after each storm event, daily during extended rain events during the construction and/or clean-up activity (e.g., weekly, or in compliance with the frequency specified in the project specific SWPPP, if applicable). Initiate repairs related to a storm event within 72 hours of identifying the problem or as soon as possible but prior to the next predicted storm event, per the CGP.

Pictures



Materials are covered and neatly stored within a curbed area.

**Corresponding
CASQA
Fact Sheet**

Fact Sheet WM-1



- What** Material Use is a procedural BMP that controls the amount or use of materials, chemicals and/or hazardous substances stored onsite and minimizes their potential for contact with storm water run-on or runoff or by non-storm water discharges.
- When** Apply the Material Use BMP when the following materials are used or prepared on site:
- Pesticides (herbicides, insecticides, and biocides).
 - Fertilizers and soil amendments.
 - Detergents.
 - Petroleum products such as fuel, oil, and grease.
 - Asphalt and other concrete components.
 - Hazardous chemicals such as acids, lime, glues, adhesives, paints, solvents, and curing compounds.
 - Mastic, pipe wrap, primers, and paint.
 - Concrete compounds.
 - Welding material.
 - Other materials that may be detrimental if released to the environment.
- Where** All construction and operations and maintenance activity sites that utilize the above materials.
- How**
- Only use products or materials onsite that have been approved through the SDG&E Product Approval process.
 - Reduce or eliminate use of hazardous materials on site when practical. Contact your Field Environmental Representative for additional information.
 - Do not remove the original product label; it contains important safety and disposal information. Use the entire product before disposing of the container.
 - Thoroughly dry empty latex paint cans, used brushes, paint rags, absorbent materials, and drop cloths. These dry wastes may be disposed of with other construction debris.
 - When possible, mix paint indoors, otherwise use secondary containment structures. Do not clean paintbrushes or rinse paint containers into a street, gutter, storm drain, sanitary sewer or watercourse.
 - Dispose of any paint thinners, residue, and sludge that cannot be recycled as hazardous waste (see BMP 2-05). For water-based paint, clean brushes to the extent practical, and rinse into a concrete washout pit or temporary sediment trap. Do not allow liquid to discharge to a storm water conveyance system. For oil-based paints, clean brushes to the extent practical and filter and reuse thinners and solvents.
 - If possible, recycle residual paints, solvents, non-treated lumber, and other materials.
 - **Do not over-apply fertilizers, pesticides, and soil amendments. Prepare only the amount needed. Strictly follow the recommended usage instructions.**





How (cont.)

- For termiticide applications (termite control pesticide) refer to CASQA Fact Sheet WM-2 "Material Use." Note that termiticide can only be applied when it is done in accordance with all applicable federal, state and local labeling requirements and in no case shall it be applied in a manner that would result in either a direct or indirect (e.g., drift) discharge to waters of the US or state.
- Keep an ample supply of spill cleanup material near use areas. Instruct employees in spill cleanup procedures.

Maintenance and Inspection

- Spot-check employees and contractors regularly throughout the job's duration to ensure appropriate practices are being employed.
- Inspect BMPs prior to and after each storm event, daily during extended rain events during the construction and/or clean-up activity (e.g., weekly, or in compliance with the frequency specified in the project specific SWPPP, if applicable).

Pictures

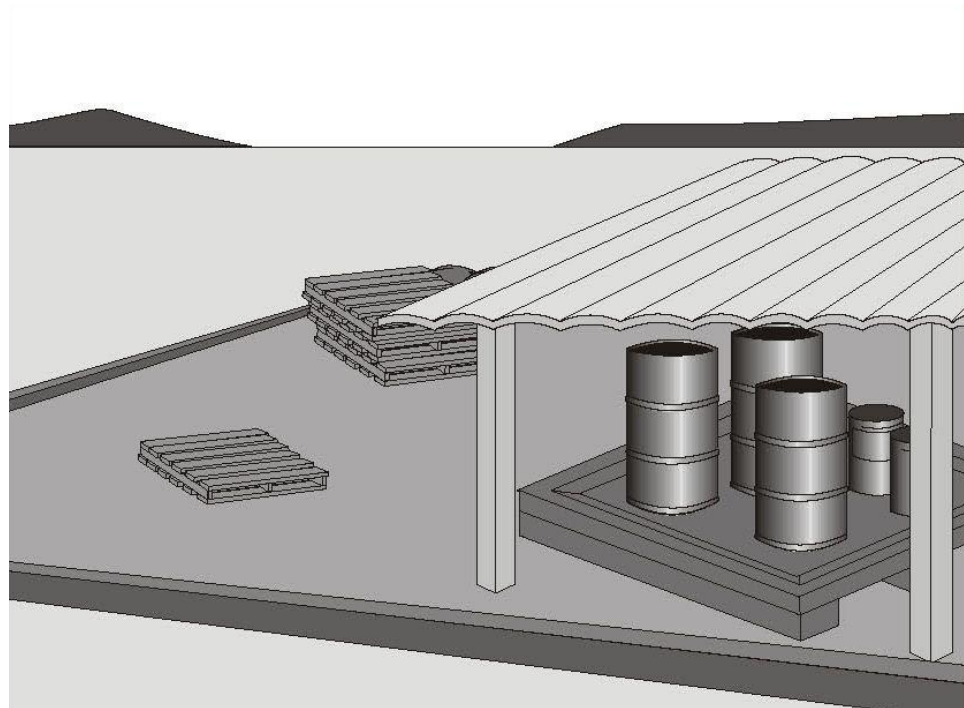

Corresponding CASQA Fact Sheet

Fact Sheet WM-2



- What** Spill Control is a procedural BMP used to control, contain, and clean-up spills on site so that storm water run-on and runoff and non-storm water discharges do not become contaminated.
- When** This BMP applies to all personnel present at construction and operations and maintenance activity sites at all times. Spill control procedures are implemented anytime chemicals (liquid or solid form) and/or hazardous materials and/or wastes are handled, used or stored. A single handling, use, or storage of a hazardous material or waste is sufficient to trigger this requirement. Such substances may include, but are not limited to fuels, lubricants, solvents, fertilizers, pesticides, herbicides, soil binders, coolants, paints, and sewage.
- To the extent that work can be accomplished safely, spills of materials or chemicals shall be contained and cleaned up immediately.
- Where** All construction and operations and maintenance activity sites where chemicals and/or hazardous materials and/or wastes are handled, used, or stored.
- How**
- Install and maintain spill control and cleanup kits in areas where any chemicals and/or hazardous materials and/or waste are handled, used and/or stored.
 - Construction Supervisor, Crew Foreman, or Facility Supervisor and sufficient onsite personnel should be trained in spill control to address potential spills on the site.
 - Only staff trained on spill response procedure should be used to control spill.
 - If the spill is a threat to life or the environment, or other emergency situation where emergency medical support, fire department response, or outside assistance is needed, ***immediately*** call the **911** Operator and the local emergency response agency (usually the local fire department). Then, promptly call **Service Dispatch (Trouble) @ (619) 725-5100** and your supervisor.
 - For all spills ***immediately*** notify the activity and site supervisor ***and/or*** the Field Environmental Representative and describe the spill and current situation. The Field Environmental Representative will make any required regulatory agency notifications per Environmental Standard (ES) G7841 and the Company's Release Reporting Scenario Guidance available on the Environmental Services Department website.
 - If possible, and if you have proper training and personal protective equipment, stop the flow of the spill. If it can be done safely, contain the spill to a confined area. Containment may be able to be accomplished with:
 - Earthen berms
 - Sand bags
 - Absorbent booms
 - Absorbent socksContainment material on site as part of the Spill Kit should reflect site characteristics. For guidance, request assistance from the Field Environmental Representative.
 - To the extent that it doesn't compromise cleanup activities, spills shall be covered and protected from storm water run-on/-off during rain events.



How (cont.)

- Immediately clean the impacted area, and properly dispose of any impacted materials.
 - Spills shall not be buried, except as necessary for immediate interim containment purposes. Spilled material and impacted burial material must be removed as soon as possible after proper control and containment and properly disposed of.
 - Use absorbent materials on spills to thoroughly clean up the material to the maximum extent possible. Spills shall not be diluted with water or other liquid for purposes of mitigating the spill (the solution to pollution is not dilution). When it is necessary to use water or other liquid for final cleaning and decontamination of a spill, the water or other liquid shall not be allowed to enter storm drain inlets, drainages, or watercourses, and shall be collected and disposed of properly. Coordinate disposal of these wastes with the Field Environmental Representative.

Used clean up materials, contaminated materials, and recovered spill material shall be stored and disposed of in accordance with federal, state and local regulations and BMP 2-05 "Hazardous Materials/Waste Management."

Maintenance and Inspection

- Perform routine inspections to verify that spill control clean-up materials are located near material storage, unloading, and use areas prior to and after each storm event, daily during extended rain events during the construction and/or clean-up activity (e.g., weekly, or in compliance with the frequency specified in the project specific SWPPP, if applicable).

Pictures

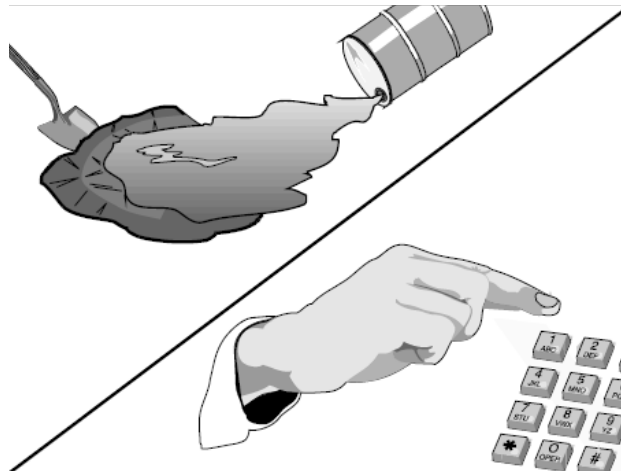

Corresponding CASQA Fact Sheet

Fact Sheet WM-4



What	<p>Solid Waste Management is a procedural BMP used to minimize site non-hazardous solid waste generation, and control the contact of site non-hazardous solid waste with storm water or non-storm water runoff.</p> <p>Examples of potential solid wastes requiring management control BMPs include, but are not limited to:</p> <ul style="list-style-type: none">• Concrete, cement, asphalt rubble, masonry brick/block.• Vegetation debris, general trash, and materials used to transport and package construction materials.• Steel and scrap metals, pipe, electrical cuttings and equipment parts.• Hazardous Materials/Waste Management is covered in BMP 2-05.
When	<p>During all phases of construction or operations and maintenance activities</p>
Where	<p>These BMPs should be used on all construction projects and operations and maintenance activities that generate solid waste.</p>
How	<ul style="list-style-type: none">• Practice good housekeeping and keep site clean.• Use dry methods for site cleanup such as sweeping, vacuuming and hand pick-up.• Designate a waste storage area on site. If a designated waste storage area is not feasible, remove wastes from the site regularly.• Prohibit littering by employees, contractors and visitors.• Trash receptacles with lids or weatherproof covers should be available on site and/or on construction vehicles.• Cover or close lids of all waste containers at the end of each day and prior to rain.• Protect wastes from being washed away by rain, storm water run-on, or other waters (irrigation, water line breaks, etc.).• To prevent storm water run-on from contacting stored solid waste (stockpiled materials) use berms, secondary containment, covered dumpsters/roll-offs or other temporary diversion structure or measures (BMP 1-08 "Stockpile Management").• For materials with the potential for spills or leaks, stockpile the material on impervious surfaces or on plastic groundcovers to prevent spills or leaks infiltrating the ground.• Do not hose out or clean out dumpsters or containers at the construction site.• Prevent solid waste and trash from entering and clogging storm drain inlets.• As practical, incorporate any removed clean sediment and soil back into the project.
Maintenance and Inspection	<ul style="list-style-type: none">• Collect site trash regularly, especially before rainy or windy conditions. Perform routine inspections of site, including storage areas, dumpsters, stockpiles and other areas where trash and debris are collected prior to and after each storm event, daily during extended rain events during the construction and/or clean-up activity (e.g., weekly, or in compliance with the frequency specified in the project specific SWPPP, if applicable). Close trash can lids and dumpster covers at the end of each day and before rainy or windy conditions.

**Corresponding
CASQA
Fact Sheet**

Fact Sheet WM-5



What Hazardous Materials/Waste Management is a procedural BMP for the use, control, containment, and disposal of hazardous materials and waste. This BMP is to be used in conjunction with SDG&E Environmental Standard (ES) G 8724 Hazardous Materials/Waste Management.

Examples of potential hazardous materials and waste requiring management control BMPs may include, but are not limited to:

- Petroleum products such as oil, fuel, grease, cold mix, and tar.
- Glues, adhesives, and solvents.
- Herbicides, pesticides, and fertilizers.
- Paints, stains, and curing compounds.
- Other hazardous or toxic substances.

When Use this BMP during all phases of construction or operations and maintenance activity when the activity involves the storage and use of hazardous materials, or the generation of hazardous waste byproducts.

Where All applicable construction and operations and maintenance activity sites where hazardous materials are used and/or hazardous waste is generated. A single instance of handling, use, or storage of a hazardous material or waste is sufficient to trigger this requirement.

How Hazardous materials and hazardous wastes shall be managed in accordance with the following procedures:

- Only use products or materials onsite that have been approved through the SDG&E Product Approval process.
- Minimize the amount of hazardous materials stored at the site and the production and generation of hazardous waste at the site.
- Cover or containerize and protect from vandalism and exposure any hazardous materials and hazardous wastes.
- Clearly mark all hazardous materials and hazardous waste containers per the ES. Place hazardous waste containers in watertight storage sheds for hazardous waste containers. Alternately, use secondary containment systems, but watertight storage sheds are preferred when hazardous waste containers are stored at the construction site.
- Hazardous materials and hazardous waste containers must meet DOT type and specifications per the ES. The containers must be closed (hand tightened) during activity hours and securely tightened during non-activity hours.
- Stockpiled cold mix should be placed on and covered with plastic.
- Mixing of waste materials is strictly prohibited.
- Storm water that collects within secondary containment structures must be inspected prior to being discharged to ensure no pollutants, oil sheens or non-stormwater discharges are present.
- Spills cannot be discharged to the environment from secondary containment (see BMP 2-03 "Spill Control").



How (cont.)

- All secondary containment systems for hazardous materials or hazardous wastes must be able to hold the volume of the largest container in the storage area and, if uncovered, sufficient additional capacity for storm events. A general rule of thumb for Southern California is that the additional containment volume for an anticipated rain event can be approximated by adding at least an additional four inches (a 4-inch rain) to the height of the containment sized for the entire waste volume of the largest container (Based on the Los Angeles Area 10 year, 24 hour precipitation frequency and a 24-hour manned facility). However, even within Southern California, this varies by the geographic region precipitation frequency and the hours of operation of the facility (containment inspection frequency). Consult with your Field Environmental Representative for determining the minimum volume required for the specific situation and geographical location.



- Hazardous waste must be segregated from other solid waste and stored and disposed of properly according to the ES. **Only company approved vendors with current contracts in place will be used to manage or dispose of hazardous wastes.**
- In addition to following this BMP and ES G8724, employees or contractors are responsible for compliance with federal, state, and local laws and regulations regarding storage, handling, transportation, and disposal of hazardous waste.

Maintenance and Inspection

- Routinely inspect the covers on hazardous material storage areas for tears or flaws and repair as necessary. Drums and drum storage areas are to be inspected at least weekly and the results recorded on an inspection log.
- All secondary containment systems for hazardous materials or hazardous wastes must be able to hold the volume of the largest container in the storage area and, if uncovered, sufficient additional capacity for storm events. A general rule of thumb for Southern California is that the additional containment volume for an anticipated rain event can be approximated by adding at least an additional four inches (a 4-inch rain) to the height of the containment sized for the entire waste volume of the largest container. Check with your Field Environmental Representative in the event you are unsure whether sufficient secondary containment exists for any facility.
- Inspect BMPs prior to and after each storm event, daily during extended rain events during the construction and/or clean-up activity (e.g., weekly, or in compliance with the frequency specified in the project specific SWPPP, if applicable) to ensure that no hazardous materials or waste are improperly left exposed to storm water. Immediately initiate repairs related to a storm event and no later than within 72 hours of identifying the problem or as soon as possible but prior to the next predicted storm event.

Corresponding CASQA Fact Sheet

Fact Sheet WM-6



What	Contaminated Soil Management is a procedural BMP for the control of contaminated soils, or soils suspected of being contaminated, that are encountered during site activities. Importation of fill shall also be managed in accordance with G8755 Import Fill Materials for Large Projects (>100 Cubic Yards), Projects within Coastal Zone, and Environmentally Sensitive Areas.
When	This contaminated soil management BMP should be used whenever soil is imported for fill, soil contamination is suspected, or when contaminated soil is encountered during construction or operation and maintenance “construction like” activities. Construction crews should be vigilant when projects are located in highly urbanized or industrial areas or in highway or roadway right-of-ways.
Where	All construction or “construction like” activity sites, but especially construction and operation and maintenance sites in urbanized or industrial areas where soil contamination may have occurred because of spills, illicit discharges, and leaks from underground storage tanks. Contaminated soils may also be encountered during digging and trenching activities on highway and roadway right-of-ways.
How	<p>Contaminated soil (including soil import that may be contaminated) should be managed in accordance with the following procedures:</p> <ul style="list-style-type: none">• Identify contaminated soil by looking for the following:<ul style="list-style-type: none">○ Soil that is discolored, black, gray, white; or○ Soil that has an unusual odor, such as, petroleum, acid, alkaline, sewage, solvent, or any other chemical smell.• If any potentially contaminated soil is detected, immediately discontinue the activity and contact the project’s Field Environmental Representative.• The CGP requires that the discharger sample and test contaminated soils to ensure proper handling and notify the appropriate local, State and federal agencies, as well as the appropriate Regional Water Board if there is a reportable release event. A reportable release is a discharge or release of oil, hazardous materials or wastes, hazardous substances or chemicals in quantities that may be harmful to the public health. This includes non-stormwater discharges of any kind into the stormwater conveyance system.• Contaminated soils must also be managed properly per SDG&E Environmental Standards (ES). See ES G8729; G8724; and G8755.
Maintenance and Inspection	<ul style="list-style-type: none">• Inspect all imported fill for contamination per Environmental Standard G8755.• Perform routine inspections of digging and trenching operations during construction and operation and maintenance activities looking for contaminated soils in addition to normal BMP inspections prior to and after each storm event, daily during extended rain events during the construction and/or clean-up activity (e.g., weekly, or in compliance with the frequency specified in the project specific SWPPP, if applicable). Immediately initiate repairs related to a storm event no later than within 72 hours of identifying the problem or as soon as possible but prior to the next predicted storm event, per the CGP.• All contaminated soils must be managed properly in accordance with applicable federal, state, and local laws and regulations.

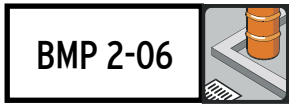

**Corresponding
CASQA
Fact Sheet**

Fact Sheet WM-7



What	Sanitary/Septic Waste Management is a procedural BMP for the control of sanitary/septic wastes. Sanitary/Septic waste is domestic (human) waste.
When	When construction or operation and maintenance site location requires onsite sanitary/septic waste portable toilets, or hand wash/rinse stations, or shower units.
Where	All applicable construction and field operations and maintenance sites.
How	<p>Sanitary/septic wastes shall be managed in accordance with the following procedures:</p> <ul style="list-style-type: none">• Incorporate into regular safety meetings the education of employees, contractors, and suppliers on:<ul style="list-style-type: none">○ Potential dangers to humans and the environment from contact with sanitary/septic wastes due to bacteria, viruses, and parasites.○ Approved sanitary/septic waste storage and disposal procedures.• Use only reputable, licensed sanitary/septic waste facility providers and haulers for sanitary facilities (portable toilets, hand wash stations, shower units) and their transportation to and from the construction site.• Ensure that sanitary facilities are equipped with secondary containment to prevent discharge of pollutants to the storm water drainage system or receiving water.• Sanitary facilities should be located away from drainage systems and watercourses, minimizing the likelihood of leaks or spills contaminating waterways.• Sanitary facilities should be located away from highways and roadways to avoid vehicles colliding with the sanitary units.• When subjected to high winds, risk of high winds, or risk of vandalism, sanitary facilities shall be secured to prevent overturning.• Sanitary wastewater should not be buried or discharged, except to a properly permitted sanitary sewer discharge facility. A permit may be required from the local Sanitation District.• Temporary sanitary facility's holding tanks shall be emptied by a licensed waste hauler prior to transport.
Maintenance and Inspection	<ul style="list-style-type: none">• Perform inspections of sanitary facilities and BMPs routinely prior to and after each storm event, daily during extended rain events during the construction and/or clean-up activity (e.g., weekly, or in compliance with the frequency specified in the project specific SWPPP, if applicable). Initiate repairs related to a storm event within 72 hours of identifying the problem or as soon as possible but prior to the next predicted storm event, per the CGP.• Ensure that sanitary/septic facilities are maintained in good working order and routinely serviced by a licensed service.• When servicing of portable sanitary facilities is conducted, wash/rinse water shall, not be allowed to runoff and shall be collected and disposed of properly in accordance with federal, state, and local requirements.

Pictures

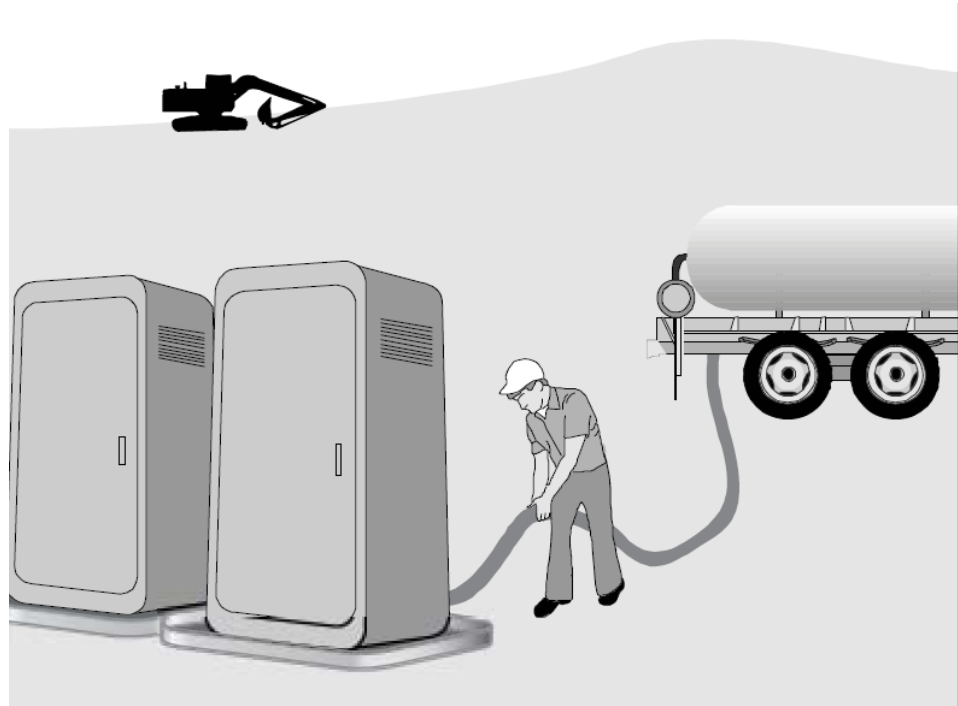

**Corresponding
CASQA
Fact Sheet**

Fact Sheet WM-9



- What** Non-hazardous Liquid Waste/Drilling Fluid Management is a procedural BMP for managing non-hazardous liquid wastes on a construction or operation/maintenance activity site.
- Hazardous liquid wastes, including water with an oily sheen, should be managed using BMP 2-05 "Hazardous Materials/Waste Management."
- Dewatering operations, and concrete slurry residue should be managed according to BMP 3-01, and BMP 3-05, respectively.
- Non-hazardous Liquid wastes include, but are not limited to:
- Drilling slurries/muds and fluids, and waste water and rinse water without an oil sheen (including pressure washing).
 - Dredging spoil, and non-storm water liquid discharges that do not have discharge permits.
- When** Liquid waste management is applicable when construction projects and operations and maintenance activities generate any non-hazardous liquid byproducts, residuals,, or wastes.
- Where** All applicable construction and operations and maintenance sites where non-hazardous liquid waste is present.
- How**
- Vehicle and equipment cleaning using water is discouraged on site. If washing is required for safety or for the work, utilize BMP 3-03 "Vehicle and Equipment Washing."
 - Drilling residue and drilling fluids should be disposed of in accordance with federal, state and local requirements. Coordinate the disposal of these wastes with your Field Environmental Representative.
 - Wastes generated as part of a construction, operation, or maintenance procedure, such as water laden with dredged material and drilling mud should be contained and not allowed to flow into drainage channels, storm drains, or receiving waters.
 - Contain non-hazardous liquid wastes in a controlled area and manner, such as a lined pit, lined roll-off bin with a sealed bottom, or a portable tank.
 - Storage tanks used for collecting and settling non-hazardous water shall be routinely checked for leaks and to ensure they are not overfilled.
 - Piping used to connect storage tanks shall be routinely checked to ensure connections are secure and not leaking.
 - Containment devices must be of sufficient quantity or volume to completely contain the liquid wastes generated and, if uncovered, any additional volume needed for anticipated precipitation. A general rule of thumb for Southern California is that the additional containment volume for an anticipated rain event can be approximated by adding at least an additional four inches (a 4 inch rain) to the height of the containment sized for the entire waste volume. Contained material must be routinely removed and properly disposed of in accordance with federal, state and local requirements.
 - **Do not locate containment areas or devices where accidental release of the contained liquid can threaten health or safety, or discharge to watercourses, storm drain system, or to a water body.**
 - Capture all liquid wastes running off a surface including wash water and rinse water from cleaning walls or pavement, including pressure washing.





How (cont.)

- If the liquid waste is sediment laden, use a sediment trap (see BMP 1-10) or capture in a containment device and allow sediment to settle.
- Disposal of liquid wastes are subject to specific laws and regulations, or to requirements of other permits secured for the construction project. Contact your Field Environmental Representative for further information.

Maintenance and Inspection

- Remove deposited solids from containment areas and containment systems as needed, and at the completion of the project. Soil, dredged material and drilling mud to be transported offsite for reuse or disposal must first be profiled using chemical analysis. Liquid waste disposal may also need to be profiled prior to transportation and disposal. Contact the Field Environmental Representative as far in advance of the anticipated transportation need as possible.
- Inspect containment systems routinely for damage, and repair as needed.
- BMPs prior to and after each storm event, daily during extended rain events during the construction and/or clean-up activity (e.g., weekly, or in compliance with the frequency specified in the project specific SWPPP, if applicable). Initiate repairs related to a storm event within 72 hours of identifying the problem or as soon as possible but prior to the next predicted storm event, per the CGP.

Pictures

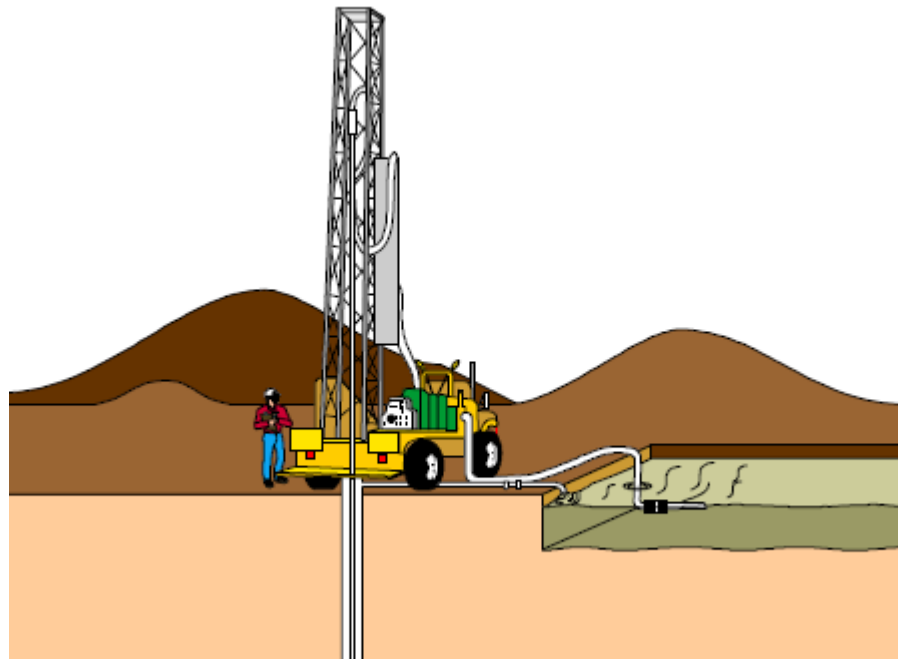

Corresponding CASQA Fact Sheet

Fact Sheet WM-10

BMP DETAILS 3



Section 3 - Non-Storm Water Discharge Controls

What Is Non-Storm Water?

Non-storm water is any water that does not originate as rain or snowmelt, or is rain or snowmelt that has come into contact with pollutants caused by human activities at construction and industrial sites, and commercial and residential sites.

Why Are Non-Storm Water Discharge Controls Required?

Storm water conveyance systems (natural or manmade, wet or dry) are, by regulation, for conveying storm water or exempt or permitted non-storm water discharges only. Storm water conveyance systems eventually discharge to natural water bodies. Non-storm water, which may reach these storm water conveyance systems, may contain pollutants, such as sediment, that are harmful to the natural water bodies. Also, sediment from construction sites can clog storm water systems or reduce the volume of storm water that can be handled by the storm water system.

What Are Non-Storm Water Discharge Controls?

Non-Storm Water Discharge Controls include general site and operations BMP measures that minimize pollution of water. Non-Storm Water Discharge Controls presented in this Manual include the following:

- BMP 3-01 Dewatering Operations
- BMP 3-02 Paving Operations
- BMP 3-03 Vehicle and Equipment Washing
- BMP 3-04 Vehicle and Equipment Fueling
- BMP 3-05 Concrete/Coring/Saw Cutting and Drilling Waste Management
- BMP 3-06 Dewatering Utility Vaults
- BMP 3-08 Over-Water Protection
- BMP 3-09 Paint Removal Control
- BMP 3-10 Stream Crossings
- BMP 3-11 Clear Water Diversion

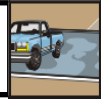

What Dewatering Operations is a procedural BMP for controlling construction or operations and maintenance dewatering to assure regulatory compliance.

- When**
- This BMP is applicable when groundwater from an excavation, trench, or non-storm water from a pipeline hydrostatic test must be removed.
 - When excavation/trench dewatering, also see Environmental Standard (ES) 104.0226.
 - When dewatering hydrostatic test water, also see ES 104.0220.
 - **This BMP is not Applicable to drilling mud or similar products used in drilling foundations (see BMP 2-08 "Non-hazardous Liquid Waste/Drilling Fluid Management")**
 - **This BMP is not applicable to utility vault or sub-structure dewatering. For these applications, refer to the BMP 3-06 "Dewatering Utility Substructures and Vaults."**
 - **This BMP is not applicable when the water is known, or suspected to be, contaminated. Under these conditions, contact your Field Environmental Representative.**
 - **Water from dewatering operations cannot be discharged to the sanitary sewer, storm drain systems, drainages, creek beds (even if dry), or to water bodies without a permit. This prohibition includes groundwater dewatering to these conveyance systems or water bodies (groundwater may contain pollutants not easily detected except by analytical laboratory tests).**
 - **Groundwater from excavation or trench dewatering or hydrostatic test water cannot be discharged to land without a permit or permit waiver. Groundwater and hydrostatic test water may contain pollutants not easily detected except by analytical laboratory tests.**
 - Non-contaminated discharges of water from hydrostatic tests of new pipe utilizing potable water as a water source, reused for soil compaction and dust control, or reused for agricultural irrigation may be allowed to be discharged to land without a permit or under a permit waiver, depending on the local and regional regulatory requirements. Consult with your project Field Environmental Representative for permitting applicability prior to planning a discharge.

IMPORTANT POINT

Where All construction sites and operations and maintenance activity sites that require excavation or trench dewatering, or pipe hydrostatic test discharges.

How Water generated by dewatering activities should be managed in accordance with the following procedures:

- If allowed by regulations, permit, or the regulating agencies, use the water for construction activities such as onsite soil compaction and dust control. If used for these applications, ensure that the water does not run-off to storm drain systems, drainages, creek beds (even if dry), or to water bodies.
 - The water may contain uncontaminated sediments, but the water must not be contaminated with other pollutants.

Note: Discharge to land for site compaction, dust control or for infiltration (to groundwater) may require a permit or permit waiver to discharge from the Regional Water Quality Control Board (RWQCBs) and/or local jurisdictions (such as Flood Control District). Consult with your Field Environmental Representative.

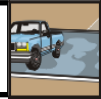

How (cont.)

- If allowed by regulations, permit, or the regulating agencies, water from dewatering, that contains only uncontaminated sediment, may be discharged to one of the following:
 - To land for infiltration (also see soil compaction and dust control above). In some locations, a permit may be required from the RWQCB and/or a local jurisdiction (such as a Flood Control District). Consult with your Field Environmental Representative. The permit may allow sediment without settling or filtration. The permit may specify limits on other pollutants, requiring sampling and analysis, and submittal of analysis results prior to discharge approval. If allowed by regulations, permit, or the regulating agencies, infiltrate to an appropriate landscaped, vegetated, or soil area. If used for these applications, ensure that the water will infiltrate and not run-off to storm drain systems, drainages, creek beds (even if dry), or to water bodies. Land owner permission to discharge to land for infiltration is required.
 - To the Sanitation or Wastewater District Sanitary/Industrial Sewer - Requires a permit or approval of the above wastewater authority. District may require sampling and analysis and a Batch Discharge application (application for a short-term discharge of a stated volume) prior to approval. District may set a numeric limit on the amount of acceptable sediment discharged. District may require a fee, dependent on discharge volume and pollutant load.
 - To Surface Water (including storm drains) - A RWQCB discharge permit is required and a local jurisdiction permit (such as a Flood Control District permit) may be required. Consult with your Field Environmental Representative. The permit may specify limits on sediment and other pollutants, require sampling and analysis, and the submittal of analysis results prior to discharge approval. These permits take advanced planning.
 - A surface water (including storm drains) discharge permit may have a numerical limit on the concentration of Total Suspended Solids (sediment) that can be discharged and a restriction limiting an increase in turbidity of the receiving water. Other pollutants, such as Oil and Grease (O&G) and Total Petroleum Hydrocarbons (TPH) may also have stringent numerical limits. As a minimum, contaminant-free temporary storage (Baker tanks) may need to be provided until permit coverage is obtained and sampling and analysis can be completed. A properly sized sediment clarifier and petroleum hydrocarbon treatment may be required. The cost of this potential treatment for discharge to surface waters should be compared to the treatment cost of discharging to the sanitary sewer (if logistically feasible) before deciding on this discharge option.
- Transport for Disposal in a Vacuum Truck for Proper Disposal. This option is usually the most expensive option and only utilized when the discharge options above cannot be permitted or is otherwise infeasible.
- If a permit is obtained for discharge to a storm water or sanitary sewer system, conduct all dewatering discharge activities in accordance with permit requirements, including installation of appropriate BMPs.
- Dewatering records should be maintained in accordance with permit requirements.



Maintenance and Inspection

- Inspect pumps, hoses and all equipment before use to ensure they are in proper operating condition and free of contamination. Monitor dewatering operations to ensure it does not cause offsite discharge or erosion.
- Monitor the discharge for any change in characteristics (amount of sediment, oil sheen, color, etc.) that is not permitted. Stop the discharge immediately if there is a visual indication that the permit conditions are being exceeded.
- BMPs prior to and after each storm event, daily during extended rain events during the construction and/or clean-up activity (e.g., weekly, or in compliance with the frequency specified in the project specific SWPPP, if applicable). Initiate repairs related to a storm event within 72 hours of identifying the problem or as soon as possible but prior to the next predicted storm event, per the CGP.
- Sample dewatering discharges in accordance with permit requirements, if applicable.
- These operations and equipment should be made secure.

Pictures

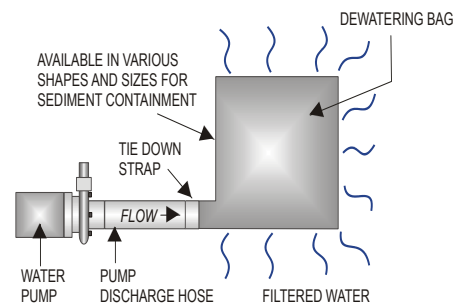

Gravity Bag Filter

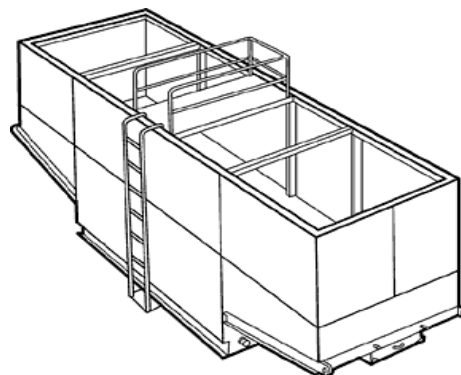

Weir Tank

Corresponding CASQA Fact Sheet

Fact Sheet NS-2

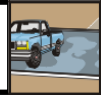

What Paving Operations is a procedural BMP for controlling non-storm water discharges associated with pavement surfacing or resurfacing, patching, or pavement removal.

Paving Operations activities may typically utilize the following materials:

- Cold mix,
- Asphalt,
- Chip Seal, Seal Coat, Tack Coat, Slurry Seal, Fog Seal, and
- Portland Cement Concrete.

For pavement grinding, saw cutting, coring or drilling, refer to BMP 3-05 "Concrete/Coring/Saw cutting and Drilling Waste Management."

When Use this BMP whenever paving operations are being conducted.

Where All construction or operations and maintenance work sites that have paving activities.

How Use the following methods as applicable:

- Protect storm drain inlets near work and down gradient of the area to be paved (see BMP 1-06 "Storm Drain Inlet Protection").
- If onsite mixing is planned, an area must be designated for conducting the mixing. This area should already be paved or made impervious (e.g., plastic or wood sheeting) and be located away from storm drain inlets, drainages, or watercourses.
- Minimize overspray of tackifying emulsions or placement of other paving materials beyond the limits of the area to be paved. Schedule the application of tackifying agents according to manufacturer's instructions regarding rain events.
- Use dry methods to clean equipment and conduct cleaning in accordance with BMP 3-03 "Vehicle and Equipment Washing."
- Material use and stockpiles are to be managed in accordance with BMP 2-02 "Material Use" and BMP 1-08, "Stockpile Management."
- Collect and remove all broken asphalt and concrete, recycle when feasible, and dispose of materials in accordance with local, state, and federal requirements.

IMPORTANT POINT



- **Do not apply asphalt, concrete paving, seal coat, tack coat, slurry seal or fog seal if rain is expected during the application or curing period.**
- **Avoid if possible, the transferring, loading, or unloading of paving materials near storm drain inlets, drainages, or watercourses. If not possible, use BMP 1-06 "Storm Drain Inlet Protection."**
- **CGP Risk Level 2 & 3 projects, that construct concrete structures onsite or store concrete mixing materials onsite, are subject to pH Numeric Action Levels (Risk 2) or pH Numeric Effluent Limits (Risk 3) for those drainage areas of the project where the concrete construction or storage of concrete mixing or waste materials take place.**
- **CGP Type 2 & 3 projects are subject to pH Numeric Action Levels (Type 2) or pH Numeric Effluent Limits (Type 3) for active areas.**
- Inspect and maintain equipment and machinery routinely to minimize leaks.

Maintenance and Inspection

NON-STORM WATER DISCHARGE CONTROLS

Paving Operations

BMP 3-02



Maintenance and Inspection (cont.)

- Inlet protection BMPs prior to and after each storm event, daily during extended rain events during the construction and/or clean-up activity (e.g., weekly, or in compliance with the frequency specified in the project specific SWPPP, if applicable). Initiate repairs related to a storm event within 72 hours of identifying the problem or as soon as possible but prior to the next predicted storm event, per the CGP.

Corresponding CASQA Fact Sheet

Fact Sheet NS-3

NON-STORM WATER DISCHARGE CONTROLS

Vehicle and Equipment Washing

BMP 3-03

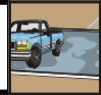

What	Vehicle and Equipment Washing is a procedural BMP for controlling vehicle and equipment washing on construction or operation and maintenance activity sites.
When	Onsite washing of vehicles and equipment on sites shall only be conducted when prior authorization has been received from the field Environmental Representative. Use this BMP on all sites when vehicle and equipment cleaning is being performed. Note that construction site vehicle and equipment washing is not typically performed on utility type construction sites unless required by safety considerations, or is necessary for work completion.
Where	Applicable to all construction and operation and maintenance sites where equipment or vehicles are washed.
How	Use the following methods as applicable: <ul style="list-style-type: none">• Use dry cleaning methods such as wiping down, rather than water washing vehicles or equipment.• If onsite vehicle washing is authorized by the Field Environmental Representative, use the following general methods:<ul style="list-style-type: none">○ Vehicle and equipment washing must be located away from storm drain inlets, drainage systems, or watercourses.○ Place secured impermeable liners, sand bags or another type of berm around storm drain inlets and drainage systems to prevent wash water from entering a storm inlet, drainage system or watercourse. Secured, impermeable liners are preferable to sand bags. Sand bags are preferable to gravel bags. Sand bags are preferable to gravel bags because they are less porous, and are much better at preventing water and pollutants from passing through the barrier.○ Never discharge wash water to the storm drain system, drainages, watercourses, or water bodies.○ Use as little water as possible. High-pressure sprayers may use less water than a hose.○ Use a positive shutoff valve to minimize water usage.○ Collect all wash and rinse water for proper disposal.
Maintenance and Inspection	Monitor employees and contractors through the duration of the construction project to ensure appropriate practices are being implemented.

Pictures

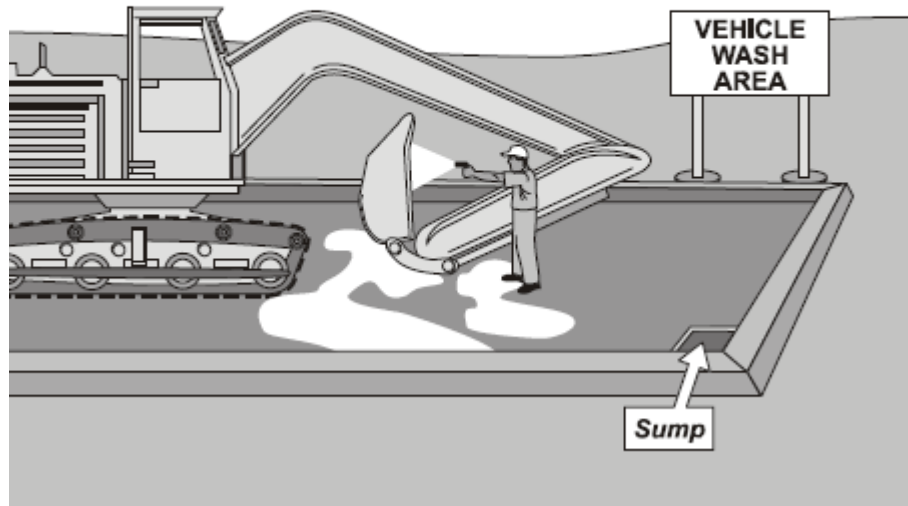

Corresponding
CASQA
Fact Sheet

Fact Sheet NS-8

NON-STORM WATER DISCHARGE CONTROLS

Vehicle and Equipment Fueling

BMP 3-04

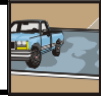

What	Vehicle and Equipment Fueling is a procedural BMP for controlling vehicle and equipment fueling at construction and operation and maintenance activity sites.
When	<p>Use this BMP for construction and operation and maintenance activity sites when onsite fueling of vehicles and equipment, including handheld equipment, is planned or conducted.</p> <p>Vehicle and equipment fueling, except for handheld equipment, is typically not done on a construction site. Onsite fueling of vehicles and equipment may be planned if it is impractical to send vehicles and equipment off site for fueling.</p> <p>Handheld equipment is treated separately from other equipment. Handheld equipment includes those smaller, manually operated pieces of equipment such as trenchers, mowers, chainsaws, generators, and other equipment that need fueling during regular daily operation.</p>
Where	All construction and operation and maintenance activity sites where vehicle and equipment fueling occurs.
How	<ul style="list-style-type: none">• If practical, fuel vehicles and equipment off site.• Mobile fueling equipment is the preferred equipment used for construction site fueling.• Fuel storage and fueling areas should be located away from storm drain inlets, drainage systems, watercourses, and water bodies.• All fueling will be conducted with the fueling operator in attendance at all times regardless if fuel nozzles are equipped with automatic shutoff features.• Fuel tanks should not be “topped off.”• All fueling operators should have readily available spill containment and cleanup equipment and materials.• Clean up spills immediately and properly dispose of contaminated materials.• Properly store and dispose of rags and absorbent material used to clean up spilled fuel.• Mobile fueling trucks and operators must have all necessary permits, licenses and training.
Maintenance and Inspection	<ul style="list-style-type: none">• Check to ensure that there is an adequate supply of spill cleanup materials available.• Perform routine inspections of designated fueling areas and inspect vehicles and equipment for leaks.• Report all spills immediately to the project Supervisor <i>and/or</i> the Field Environmental Representative.

Pictures

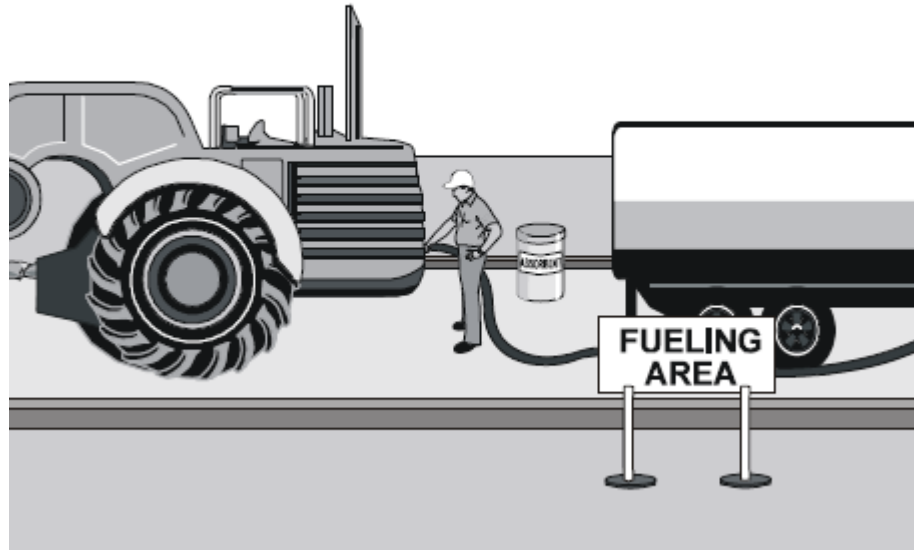

**Corresponding
CASQA
Fact Sheet**

Fact Sheet NS-9

NON-STORM WATER DISCHARGE CONTROLS

Concrete/Coring/Saw Cutting and Drilling Waste Management

BMP 3-05

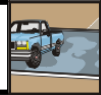

- What** Concrete/Coring/Saw Cutting and Drilling Waste Controls are procedural BMPs for the proper management of liquid and solid wastes from concrete/coring/saw cutting and drilling activities.
- For managing any concrete curing compounds, also use BMP 2-05 "Hazardous Materials/Hazardous Waste Management." For managing paving operations, use BMP 3-02.
- When** Use this BMP at construction and operation and maintenance activity sites when the activity utilizes concrete and asphalt or when slurry or pavement/concrete wastes are generated by the activities, including:
- Saw cutting.
 - Coring/drilling.
 - Grinding, re-paving or patching.
 - Encasing conduit in concrete.
 - Tower footings.
- Where** All construction and operation and maintenance activity sites where the above activities are conducted.
- How**
- Install storm drain protection at any down-gradient inlets that may be impacted by the activity per BMP 1-06 "Storm Drain Inlet Protection."
 - Minimize the amount of water used during coring/drilling or saw cutting. During wet coring or saw cutting, use a wet vacuum to lift the slurry from the pavement as the coring or saw cutting progresses. Additionally, sand bag barriers or other containment should be used at nearby down gradient storm drain or drainage inlets per BMP 1-06 "Storm Drain Inlet Protection."
 - If concrete residue remains after drying, the area should be swept in a timely manner and residue removed to avoid contact with storm water or entering a storm drain or water body via the wind. If concrete residue still remains, pressure wash the surface, with in-progress vacuum recovery of wash water to remove residual material.
 - **Do not wash residue or particulate matter into a storm drain or drainage inlet or a watercourse or water body.**
 - The following options should be used for concrete truck chute and/or pump and hose washout:
 - If available, arrange to use an existing concrete washout station. Upon entering the site, concrete truck drivers should be instructed about proper site practices.
 - **Concrete Washouts:** Washout stations can be: self contained concrete trucks; commercial portable washout stations (rent-a-washout); plastic lined temporary pits, or a bermed and lined area designed with sufficient volume to completely contain all liquid and waste concrete materials plus enough capacity for rainwater. The lining must be impervious (such as Visqueen with no holes or tears). The designated area must be located away from storm drain inlets, drainages, watercourses, or water bodies.
 - **Washout in Trench:** Manually rinse the concrete truck chute into the lined trench itself. Note that this practice is not allowed on CGP projects, where minimum BMPs in the permit require containment of concrete washout areas and prohibits discharge into the underlying soil or surrounding areas. Check with the Field Environmental Representative regarding site-specific applicability.



NON-STORM WATER DISCHARGE CONTROLS

Concrete/Coring/Saw Cutting and Drilling Waste Management

BMP 3-05

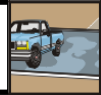

How
(cont.)

IMPORTANT
POINT



**Maintenance
and
Inspection**

**Corresponding
CASQA
Fact Sheet**

- **Bucket Washout:** Manually rinse the chute into a wheelbarrow, plastic bucket or pail, and then empty the bucket into the concrete truck barrel or on top of the placed concrete within a trench or excavation. Prevent or protect against spillage, and clean up any spillage promptly.
- **CGP Risk Level/Type 2 & 3 projects, that construct concrete structures onsite or store concrete mixing materials onsite, are subject to pH Numeric Action Levels (Risk/Type 2) or pH Numeric Effluent Limits (Risk/Type 3) for those drainage areas of the project where the concrete construction or storage of concrete mixing or waste materials take place.**
- Responsible personnel should ensure that all drivers of concrete trucks arriving onsite are instructed about proper project practices.
- Clean out designated washout areas as needed or at a minimum when the washout is 75 percent full to maintain sufficient capacity throughout the project duration. Add additional designated areas as necessary and available to maintain capacity.
- Any designated onsite washout areas must be cleaned out and all debris removed upon project completion. Dispose of concrete waste according to BMP 2-04 "Solid Waste Management."
- Inspect routinely, when washout activities are underway to ensure the integrity of the concrete washout lining and that the concrete washout does not overflow.

Fact Sheet WM-10

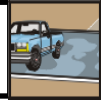

- What** Dewatering Utility Vaults is a procedural BMP for controlling water from dewatering utility vaults and underground structures. This BMP does not apply to trench, excavation or other general dewatering associated with construction activities, which is covered by BMP 3-01.
- When** This BMP is applicable whenever water must be removed from SDG&E utility vaults and underground structures.
- Where** All SDG&E utility vault locations.
- How** The discharge of clean water from dewatering of vaults and underground structures to the storm drain, drainages, or water bodies is allowed under the statewide General NPDES Permit for Discharges from Utility Vaults and Underground Structures to Surface Waters (Order No. 2006-0008-DWQ and NPDES No, CAG990002).
- Discharges to land (e.g., vegetation, bare soil area) are not covered by this permit. A Waste Discharge Requirements (WDR) permit or waiver may be required by the local Regional Water Quality Control Board (RWQCB) for discharges to land. If a RWQCB does not have a general WDR or waiver for discharges to land, then the State Water Resources Control Board (SWRCB) General Permit for dewatering to land may apply. Consult with your Field Environmental Representative. Discharges to land also require the prior approval from the landowner.
- General requirements for discharge under Order 2006-0008-DWQ/Permit Number CAG990002) are listed below:
- All vault dewatering discharges conducted by utility crews, including contractors, shall follow the latest version of SDG&E's Environmental Standards (ES) on Vault and Underground Structure Dewatering. For dewatering utility gas/electric vaults & underground structures follow ES <http://techdocs.sempra.com/doclib.nsf/docframe?openform&docno=G8718>.
 - Prior to discharge, the water in the vault shall be assessed in accordance with the requirements in the ES.
 - A SDG&E-approved filter system with hydrocarbon removal capability is required to be used on the pump discharge for compliance assurance when dewatering to a surface water (drainage, gutter, storm drain inlet, or a water body).
 - **If the water to be discharged is Clear Water as described in the ES, then the discharge to storm drains, drainages, or water bodies is acceptable as long as the discharge does not cause nuisance or harm to the environment.**
 - Water discharged to the street, gutter, drainages, watercourses, or water bodies must be clean and clear, with no evidence of oil sheen and no chemical or sewage smell.
 - The dewatering discharge must be monitored at all times during the discharge to ensure the discharge is "clean and clear" with no chemical or sewage odor. If the characteristics of the discharge change (i.e., color, smell, sheen), the discharge must be stopped immediately. In such an event call the Field Environmental Representative.
 - Whenever possible, discharge the clean, clear water directly to the storm drain, drainage, or water body to avoid pre-existing pollutants in the discharge path. Pre-existing soil or contaminants in the path of the discharge (i.e., gutter) that can discolor/contaminate the discharge need to be cleaned up before discharging vault water.



NON-STORM WATER DISCHARGE CONTROLS

Dewatering Utility Vaults

BMP 3-06



IMPORTANT POINT

How (cont.)

- The discharge from the filter system must be clean and clear at all times, and if not, the discharge must be stopped.
- As a last resort, when the water, because of sediment or pollutant contamination, cannot be discharged to the environment, contact the project Field Environmental Representative for transport of the water in an approved manner (see the linked SDG&E ES from the previous page).

Maintenance and Inspection

- Implement applicable provisions of the ES.
- Inspect pumps, hoses, filter system and equipment before use and routinely when applicable activities are underway.
- Observe dewatering activities to ensure they do not cause erosion or discharge of potential pollutants.

Corresponding CASQA Fact Sheet

Not applicable. See also Fact Sheet NS-2, Dewatering Operations

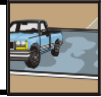

What	<p>Over-Water Protection is a procedural and containment system BMP for protecting watercourses from overhead construction and maintenance and repair activities.</p> <ul style="list-style-type: none">• Over-water construction and maintenance activities include, but are not limited to, chipping, grinding, scraping, welding/burning, painting, wrapping and coating of pipes and conduits.• Watercourses (dry or wet) include drainages, creeks, streams, rivers, lakes and wetlands, bays, estuaries and oceans.
When	<p>This BMP applies to projects when:</p> <ul style="list-style-type: none">• Construction, maintenance or repair activities will be conducted above watercourses (dry or wet). <p>Prior to conducting over-water activities, check with the Field Environmental Representative for the possible need for permits with the appropriate local and state agencies. As an example, the design or installation of a containment system may itself impact the watercourse and require a permit, or the timing of the activity may impact wildlife breeding seasons, requiring a permit or preventing the activity during certain portions of the year.</p>
Where	<p>All construction or operation and maintenance activity above any portion of a watercourse.</p>
How	<p>Use the following measures as applicable:</p> <ul style="list-style-type: none">• Containment systems must be properly designed and installed prior to the beginning of any operation that may impact a water body to prevent discharge of pollutants to surface waters, taking into account the construction or maintenance activity and factors such as wind, rain, etc.• The work area should be kept clean of all trash and potential pollutants.• Containment booms should be placed around the area of work as necessary to contain the discharge of potential contaminants such as oil and hydraulic fluid.• Special attention should be given to existing and forecasted wind and weather conditions to prevent pollutant discharges to surface waters.• Shrouds of appropriate material should be used to prevent paint overspray, welding slag, and other pollutants from entering surface waters. Shrouding may not be effective during periods of high wind.• Shrouds should be large enough to adequately enclose or segregate the working area from surface waters. This may include a plywood barrier, Visqueen, and scaffolding to help prevent fugitive material from entering surface waters.• Support structures such as scaffolding shall be used in conjunction with shrouding to withstand potential wind stress.• Contaminated shrouding material and equipment shall be thoroughly cleaned or disposed of properly.
Maintenance and Inspection	<ul style="list-style-type: none">• Inspect the containment systems, shrouds, and support structures prior to and after each storm event, daily during extended rain events during the construction and/or clean-up activity (e.g., weekly, or in compliance with the frequency specified in the project specific SWPPP, if applicable) to ensure their integrity and safety. Initiate repairs related to a storm event within 72 hours of identifying the problem or as soon as possible but prior to the next predicted storm event.

Pictures



**Corresponding
CASQA
Fact Sheet**

Fact Sheet NS-14

NON-STORM WATER DISCHARGE CONTROLS

Paint Removal Control

BMP 3-08



What	Paint Removal Control is a procedural BMP for protecting storm water and water courses from mark-out paint or graffiti paint removal activities.
When	Use this BMP when utility activities have used mark-out paint on surfaces and the paint is required to be removed by local jurisdictions or another authority, or when graffiti on company property is discovered and must be removed.
Where	Mark-out paint is usually used on road, sidewalk, and land surfaces to show the location of underground utility services. Graffiti on company property may have been painted on company fences or walls, buildings, walkways, curbs or other surface.
How	<p>Use the following options to remove mark-out paint or graffiti:</p> <ul style="list-style-type: none">• Use non-toxic, light degradable mark-out paint when possible.• Avoid the use of chemical paint removers whenever possible. When chemical paint removers are required, only use products that have been approved through the product review process and utilize containment and wet vacuuming of material during the removal process.• Hydro pressure wash.• Dry abrasive blast/grinding.• Wet abrasive blast/grinding. <p>Use one or more of the following methods to promptly and effectively contain and remove paint and residues in order to protect storm water sewers, drainages and watercourses:</p> <ul style="list-style-type: none">• Dry sweep.• Install storm drain inlet protection at down gradient inlets during hydro pressure washing, wet abrasive blasting, grinding, and chemical removal. Discharge of any wet or dry residuals or wash water to the drainage system is prohibited.• Minimize the amount of water used during hydro pressure washing.• Wet or dry vacuum.• Use wet vacuum to lift the paint slurry from the pavement or surface as hydro pressure washing progresses or as soon as possible, and before the material has a chance to migrate from the work area.• If wet vacuuming is not adequate to capture all wastewater from these activities, use additional containment (sand bags, booms, or other containment devices) methods as near the work area as possible to prevent the discharge to a street, gutter, storm drain/drainage inlet, or watercourse.• If paint residue remains after drying, the area should be swept up and residue removed in a timely manner to avoid contact with storm water.• If paint residue remains after sweeping, the area can be water washed, as long as the water containing the paint residue is contained near the work and wet vacuumed and not allowed to enter storm drain inlets or watercourses.• All waste should be disposed of using the BMP 2-08 "Non-Hazardous Liquid Waste Management."
Maintenance and Inspection	<ul style="list-style-type: none">• Inspect all containment systems to ensure proper placement prior to starting utility paint removal operations.• Inspect equipment frequently and adjust as necessary to maximize efficiency and minimize water or other material use of the paint removal

NON-STORM WATER DISCHARGE CONTROLS

Paint Removal Control

BMP 3-08



operations.

**Corresponding
CASQA
Fact Sheet**

NA



What

A stream crossing is a culvert, ford, or bridge placed across a waterway to provide access for construction or operations and maintenance activities. Utility stream crossings are not intended to maintain public traffic and project-specific permits may be required for use (see "Limitations"). The crossing design and construction allows safe access and reduces erosion and downstream sediment from vehicles.

The project Field Environmental Representative should be consulted for any permit requirements and for the stream crossing location.

The following types of stream crossing should be considered:

- **Culverts:** Appropriate to control erosion, but may cause erosion during installation/removal without appropriate BMP measures. Easily constructed and allows for heavy equipment loads.
- **Fords:** A ford is a streambed crossing alternative that involves crossing a waterbody at grade, on a hard surface maintained at the streambed bottom. Appropriate during dry weather and in arid areas in dry washes, ephemeral streams, and low-flow perennial streams. Ford crossings generally involve the placement of gravel or other non-erodible material to facilitate crossing and are appropriate for streams that would benefit from additional clean native or compatible gravel; for example, salmonid streams or rivers below reservoirs, and urban, channelized streams. Fords provide minimum sediment and erosion control in a stream channel and are most appropriate when the potential for stream channel erosion and dislodgement of sediment due to the addition of the material and traffic is low. A ford is the least expensive stream crossing, allows for maximum load limits, and offers very low maintenance. Fords may degrade water quality due to vehicle and equipment contact. Direct placement of gravel may be appropriate for short-term use. In addition, soil-confinement systems can also be used in low-flow intermittent stream crossings for ease with implantation and removal. Examples include:
 - Cellular Confinement Systems (CCS) crossings consist of three-dimensional cellular-type material placed on the streambed bottom and filled with rock or soil. CCSs are an effective option when used in conjunction with ford crossings because it is sufficient to support most construction equipment and is readily removable.
 - Articulated concrete mats (e.g., concrete blocks held together by steel cable or interlocking concrete blocks) can also be used for fording a stream. Articulated concrete mats can be used to harden the streambed for crossing. Gravel should be placed on the mats to fill in the voids between concrete blocks.
 - Gabion mattresses consisting of rock contained in rectangular, wire-mesh can also be used for constructing a hard driving surface. Gabion mattresses are strong and durable, flexible structures, and are easily constructed.
- **Bridges:** Appropriate for streams with high flow velocities, steep gradients, and where temporary restrictions in the channel are not allowed. Bridges are more expensive to design and construct, but provide the least streambed disturbance and waterway flow constriction.

What



(cont.)



Limitations:

- Installation may cause a waterway constriction, which can obstruct flood flow and cause flow backups, washouts, and/or scouring.
- **Installation may require RWQCB 401 Certification, USACOE 404 permit and approval by the California Department of Fish and Game. If numerical water quality standards are mentioned in any permits, sampling and testing may be required.**
- Installation and removal will usually disturb the waterway, and may require dewatering or temporary stream diversion.
- Soil confinement systems used for stream crossings must be constructed in accordance with the manufacturer's specifications, and inspected and maintained for structural integrity.
- Gravel use in the stream for soil-confinement system crossings will require agency approval.
- Requires other BMPs to minimize soil disturbance during installation and removal.

When

Stream crossings are installed at sites when:

- Appropriate permits have been secured for activities and for the stream crossing.
- Construction or operation and maintenance equipment or vehicles need to frequently cross a waterway.
- Alternate access routes impose significant constraints.
- Crossing perennial streams or waterways without a stream crossing causes significant erosion.

Where

Stream crossings should be installed at all designated crossings of perennial and intermittent streams and in dry channels that may be significantly eroded by construction or operation and maintenance traffic at locations where:

- Erosion potential from the installation is low.
- Site runoff is not directed towards the crossing in a manner that promotes erosion of the crossing.

How



Minimum standards and specifications for the design, construction, maintenance, and removal of the structure should be established by a California Registered Civil Engineer, and for bridges, a California Registered Structural Engineer. The design flow and stability safety factor should be based on risk evaluation of overtopping, flow backups, or washout.

Construction and Use:

- Install sediment traps immediately downstream of the crossings to capture sediment. Sediment traps may also be required to be part of the crossing permit. For CCS ford crossings, the gravel depth should be 6 to 12-inches to support construction vehicular traffic. Clean, washed, angular or rounded gravel should be used with cellular-block confinement systems.



How (cont.)

- Avoid oil or other potentially hazardous materials for surface treatment.
- Stabilize construction roadways, work area, and streambed bottom against erosion. Stream bed and bank stabilization, if necessary, may also be required to be part of the crossing permit.
- Construct during dry periods to minimize stream disturbance and reduce costs.
- Construct at or near the streambed elevation to prevent potential upstream flooding.
- Install erosion control BMPs to minimize erosion of embankment into flow lines.
- Any artificial obstruction placed within flowing water should only be built from material that will not introduce sediment or silt into the watercourse.
- Vehicles and equipment should not be driven, operated, fueled, cleaned, maintained, or stored in the wet or dry portions of a water body. Wetland vegetation, riparian vegetation, or aquatic organisms could be destroyed.
- The exterior of vehicles and equipment that will encroach on the water body should be maintained free of grease, oil, fuel, and residues.
- Drip pans should be placed under all vehicles and equipment placed over water bodies (e.g., bridges) when the equipment is planned to be idle for more than one hour.
- Disturbance or removal of vegetation should not exceed the minimum necessary to complete operations. Disturbed vegetation should be replaced with the appropriate soil stabilization measures.
- Riparian vegetation, when removed pursuant to the work provisions, should be cut off no lower than the ground level to promote rapid re-growth. Access roads and work areas built over riparian vegetation should be covered by a sufficient layer of clean river run cobble to prevent damage to the underlying soil and root structure. The cobble must be removed upon completion of project activities.

Maintenance and Inspection

- Inspect and verify that activity-based BMPs are in place prior to the commencement of associated activities. While activities associated with the BMP are under way, inspect prior to and after each storm event, daily during extended rain events during the construction and/or clean-up activity (e.g., weekly, or in compliance with the frequency specified in the project specific SWPPP, if applicable). Initiate repairs related to a storm event within 72 hours of identifying the problem or as soon as possible but prior to the next predicted storm event, per the CGP.
- Check for blockage in the channel, sediment buildup or trapped debris in culverts, blockage behind fords or under bridges.
- Check for erosion of abutments, channel scour, riprap displacement, or other signs of erosion.



Maintenance and Inspection (cont.)

- Check for structural weakening of the crossings, such as cracks, and undermining of foundations and abutments.
- Remove sediment that collects behind fords, in culverts, and soil confinement systems. Removal of undesirable sediment may be required to be part of the crossing permit.
- Replace lost or displaced support aggregate from inlets and outlets of culverts and soil confinement systems.
- With proper BMPs, remove temporary stream crossings promptly when it is no longer needed.

Pictures

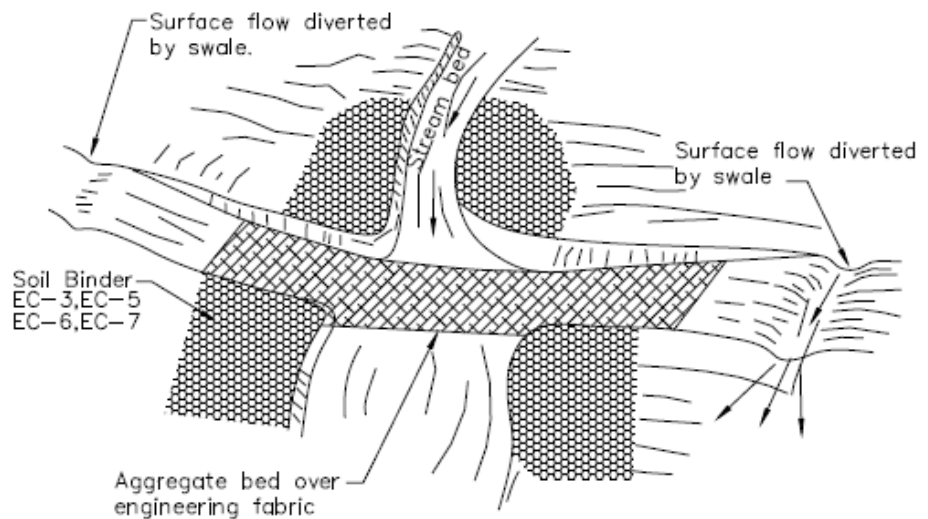

Aggregate approach
1:5 (V:H) Maximum slope on road

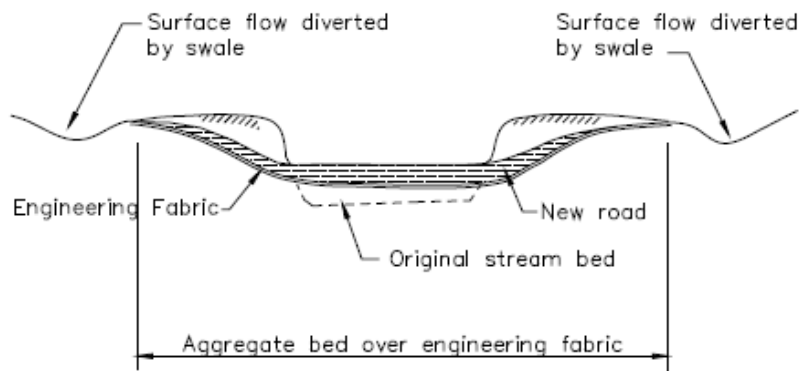

TYPICAL FORD CROSSING
NOT TO SCALE

NON-STORM WATER DISCHARGE CONTROLS

Stream Crossings

BMP 3-09

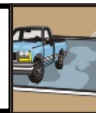

**Corresponding
CASQA
Fact Sheet**

Fact Sheet NS-4



What Clear water diversion is a system of structures and measures that intercept clear surface water runoff upstream of a construction project or operation and maintenance activity, transport it around the work area, and discharge it downstream with minimal water quality degradation. It encloses a construction area in a waterway and reduces sediment pollution from construction in, or adjacent to water. Structures commonly used as part of this system include diversion ditches, berms, dikes, slope drains, rock, gravel bags, wood, aqua barriers, cofferdams, filter fabric, or turbidity curtains, drainage or interceptor swales, pipes, or flumes.

Limitations:

- Diversion activities will usually disturb the waterway during installation/removal.
- Installation may require RWQCB 401 Certification, USACOE 404 permit and approval by California Department of Fish and Game. If numerical water quality standards are mentioned in any permits, sampling and testing may be required.
- Diversion activities may constrict the waterway, obstruct flood flows, and cause flooding or washouts. Diversion structures should not be installed without identifying potential impacts to the stream channel.
- Diversion or isolation activities are not appropriate in channels where there is insufficient stream flow to support aquatic species in the dewatered area or if they will disturb sensitive aquatic species.
- Diversion or isolation activities are inappropriate in deep water unless designed and reviewed by a California Registered Civil Engineer.
- Diversion or isolation activities should not completely dam stream flow.
- Dewatering and removal may require additional sediment control or water treatment.

When Clear water diversions should be implemented when:

- Isolating construction or operations and maintenance activities is necessary within or near a water body to protect the water body from the activity. Applicable activities may include but are not limited to: stream bank stabilization, culvert, bridge, pier, or abutment installation. They may also be used in combination with other methods, such as clear water bypasses and/or pumps.

Where

- A clear water diversion is typically implemented where appropriate permits have been secured and work must be performed in a flowing stream or water body.
- Pumped diversions are suitable for intermittent and low flow streams.
- Excavation of a temporary bypass channel, or passing the flow through a flume with a trench excavated under it, is appropriate for the diversion of streams less than 20 feet wide, with flow rates less than 100 cubic feet per second.
- Clear water diversions incorporating clean washed gravel may be appropriate for use in fish spawning streams.

**How**

In general:

- Where working areas encroach on flowing streams, barriers adequate to prevent the flow of muddy water into streams should be constructed and maintained. During construction of the barriers, stream muddying should be minimized.
- Diversion structures must be adequately designed to accommodate fluctuations in water depth or flow volume due to tides, storms, floods, etc.
- Equipment driven in a water body should be clean of petroleum residue, and water levels should be below the fuel tanks, gearboxes, and axles, unless lubricants and fuels are sealed such that water inundation will not result in pollutant discharges.
- Only excavation equipment buckets may reach out into the water body to remove or place fill. The main equipment body should not enter the water except as necessary to cross the stream to access the work site.
- Stationary equipment, such as motors or pumps located within or adjacent to a water body, should be positioned over drip pans.
- When any artificial obstruction is being constructed or maintained, sufficient water should at all times pass downstream to maintain aquatic life.
- Equipment should not park below high water marks unless allowed by permit.
- Disturbance or removal of vegetation should be minimized. Disturbed vegetation should be replaced with appropriate erosion control measures.
- Riparian vegetation, when removed pursuant to the work provisions, should be cut off no lower than the ground level to promote rapid re-growth. Access roads and work areas built over riparian vegetation should be covered by a sufficient layer of clean river run cobble to prevent damage to the underlying soil and root structure. The cobble must be removed upon completion of project activities.
- Drip pans should be placed under all vehicles and equipment placed structures over water bodies when the equipment is planned to be idle for more than one hour.
- Where possible, minimize diversion and encroachment impacts by scheduling construction during periods of low flow. Scheduling should also consider seasonal releases of water from dams, fish migration, and spawning seasons, and water demands due to irrigation.
- Construct diversion structures with materials free of potential pollutants such as soil, grease, or oil.

Several types of clear water diversions are detailed in the CASQA Handbook, each with different applications, design considerations, limitations, and inspection and maintenance requirements. These types of diversions include:

- Temporary Diversions and Encroachments
- Temporary Dry Construction Areas

NON-STORM WATER DISCHARGE CONTROLS

Clear Water Diversion

BMP 3-10



How (cont')

- Filter Fabric Isolation
- Turbidity Curtain Isolation
- K-Rail River Isolation
- Stream Diversions

The CASQA Handbook should be consulted for additional information for these clear water diversions.

Maintenance and Inspection

- Inspect and verify that activity-based BMPs are in place prior to the commencement of associated activities. While activities associated with the BMP are under way, inspect weekly during the rainy season and at two week intervals in the non-rainy season to verify continued BMP implementation (e.g., or in compliance with the frequency specified in the CGP, if applicable).

Pictures



Corresponding CASQA Fact Sheet

Fact Sheet NS-5

BMP DETAILS 4



Section 4 - Soil Erosion Control

What is Erosion?

Erosion is the detachment of soil particles by water or wind. Erosion is a natural process that can be accelerated by construction activities such as grading and trenching. For example, when a site is cleared and grubbed, protective vegetation is removed and the disturbed soil is directly exposed to wind, rain, and flowing water.

Why is Erosion Control Required?

Water or wind can transport soil particles to water bodies where they can cause damage to, or destruction of, aquatic animals and plants by burying them or reducing oxygen and/or sunlight that is necessary for their survival. Erosion control is required by regulatory agencies to minimize the potential additional erosion and damage to the environment from construction activities.

What is Erosion Control?

Erosion Controls are methods used to protect the soil surface and prevent the soil particles from being detached and transported by rain, flowing water or wind. Erosion controls include limiting soil or vegetation disturbance to reduce erosion. Preservation of Existing Vegetation is an example of an Erosion Control BMP.

Soil Stabilization is the most widely used and most effective method of erosion control. Preventing or reducing erosion potential by directing or controlling drainage runoff, as well as preparing and stabilizing disturbed soil areas protects the exposed soil surface from rain and wind thereby preventing erosion. Diversion Berms and Drainage Swales is an example of an erosion control BMP that intercepts and conveys run-on around or through the project reducing erosion potential. Hydroseeding is also an example of an erosion control BMP that stabilizes the soil. Erosion control BMPs used in this Manual to direct or control runoff and/or stabilize soil include:

- BMP 4-01 Preservation of Existing Vegetation
- BMP 4-02 Temporary Soil Stabilization (General)
- BMP 4-03 Hydraulic Mulch
- BMP 4-04 Hydroseeding
- BMP 4-05 Soil Binders
- BMP 4-06 Straw Mulch
- BMP 4-07 Geotextiles, Plastic Covers, and Erosion Control Blankets/Mats
- BMP 4-08 Dust (Wind Erosion) Control
- BMP 4-09 Diversion Berms and Drainage Swales
- BMP 4-10 Velocity Dissipation Devices
- BMP 4-11 Slope Drains
- BMP 4-12 Streambank Stabilization
- BMP 4-13 Soil Preparation

EROSION CONTROL AND SOIL STABILIZATION

Preservation of Existing Vegetation

BMP 4-01



What Preservation of Existing Vegetation is a procedural BMP that maximizes the preservation of existing trees, shrubs, bushes, and grasses on a construction or operations and maintenance activity site.

When This BMP is applicable to utility activities when there is existing vegetation.

Where All construction and operations and maintenance activity sites where:

- There are areas on site where no activity is planned or will occur later.
- There are areas with vegetation that can be preserved to protect against soil erosion, such as on steep slopes, watercourses, and building sites in wooded areas.
- There are areas designated as ESAs, or where federal, state, or local government regulations require preservation, such as wetlands, vernal pools, marshes, etc.

How Use the following measures as applicable:

- Preserve existing vegetation whenever possible.
- Identify areas to be preserved in the immediate vicinity of the construction or activity site, and mark as appropriate before clearing and grubbing or other soil disturbance activities.
- If necessary, contact the project Field Environmental Representative for any clarification regarding areas to be preserved.
- Whenever possible, minimize disturbed areas by locating temporary roadways to avoid stands of trees and shrubs and follow existing contours to reduce cutting and filling.
- Construction materials, equipment storage and parking areas should be located outside the drip line of any tree to be retained.
- Consider the impact of grade changes to existing vegetation and the root zone.
- Remove any markings, barriers, or fencing after project is completed.
- Maintain the clearly marked limits of disturbance during construction to preserve vegetation.
- Inspect barriers regularly during construction.

**Maintenance
and
Inspection
Pictures**



Vegetation to be preserved is marked and outside the work area.

**Corresponding
CASQA
Fact Sheet**

Fact Sheet EC-2



What	<p>Temporary Soil Stabilization is a procedural BMP utilizing protective materials to cover exposed soil, where the soil exposure is caused by construction or operation and maintenance activities. Materials may include hydraulic mulch and seeding, soil binders, straw, geotextiles, plastic covers and erosion control blankets.</p> <p>Temporary soil stabilization BMPs and their associated materials include:</p> <ul style="list-style-type: none">• BMP 4-03 - Hydraulic Mulch• BMP 4-04 - Hydroseeding• BMP 4-05 - Soil Binders• BMP 4-06 - Straw Mulch• BMP 4-07 - Geotextiles, Plastic Covers and Erosion Control Blankets/Mats
When	<p>This BMP, and the situation appropriate BMPs listed above, is applicable when slopes are constructed or disturbed and/or where there are inactive soil disturbance areas that will not be worked for 14 days or more. The procedures are to be implemented after slope construction activity is complete and then prior to the onset of precipitation.</p>
Where	<ul style="list-style-type: none">• Slopes, soil stockpiles, and inactive disturbed soil areas.• Soil binders (BMP 4-05) may be applicable to areas where there is light traffic that would minimize the effectiveness of other temporary soil stabilization BMPs.
How	<ul style="list-style-type: none">• Sediment control BMPs used to break up the slope lengths, such as fiber rolls (BMP 1-03) or gravel bag berms (BMP 1-04) should be spaced in accordance with the CGP requirements (see installation for BMP 1-03 "Fiber Rolls")• Permanent erosion control shall be applied to areas deemed substantially complete during the project's defined seeding season window.• Refer to individual temporary soil stabilization BMPs for specific instructions for use (see BMP 4-03 through BMP 4-07).
Maintenance and Inspection	<ul style="list-style-type: none">• Refer to individual temporary soil stabilization BMPs listed above for maintenance and inspection requirements.

Pictures



Applying a tackifier using a trailer mounted pump and hose.



Applying soil stabilization manually in harder to reach areas.

**Corresponding
CASQA
Fact Sheet**

Fact Sheet EC-2



What	<p>Hydraulic Mulch is a procedural BMP for applying mulch to protect the soil surface from wind and rain erosion.</p> <p>Mulch consists of a mixture of shredded wood fiber or other fiber in water and a stabilizing emulsion, or tackifier. The mulch is applied with hydro-mulching equipment (water mixture spraying equipment).</p>
When	<p>Hydraulic mulch is typically applied when a temporary soil cover is required for protection until permanent vegetation is established, or to disturbed areas that must be re-disturbed following a period of inactivity of 14 or more days.</p>
Where	<ul style="list-style-type: none"> • To disturbed areas requiring temporary protection. • Do not apply to active work areas where the mulch would interfere with or be destroyed by immediate earthwork activities or construction traffic. Consider using soil binders instead (BMP 4-05).
How	<ul style="list-style-type: none"> • Prior to application, roughen embankment and fill areas with a crimping or punching type roller or by track walking. Track walking shall only be used where other methods are impractical and slope angle allows safe equipment operation. Track walking must be performed upslope so that equipment tracks traverse the slope horizontally along the slope. • Avoid mulch over-spray onto the traveled way, sidewalks, lined drainage channels, and existing vegetation. • Avoid use of mulch without a tackifier component, especially on slopes. • Hydraulic Mulches: <ul style="list-style-type: none"> ○ Apply as liquid slurry using a hydraulic application machine (i.e., hydroseeder) at rates of mulch and stabilizing emulsion recommended by the manufacturer. Wood fiber hydraulic mulches are generally short-lived (only last a part of a growing season) and must be applied no less than 24 hours before rain events to dry and become effective. <ul style="list-style-type: none"> • Hydraulic Mulch with Binder (Matrix): ○ Apply a combination of wood fiber and/or paper fiber mixed with acrylic polymers as binders. Apply the mulch matrix as liquid slurry using a hydraulic application machine (i.e., hydroseeder) at rates recommended by the manufacturer. Hydraulic matrices must be applied no less than 24 hours before a rain event to dry and become effective. <ul style="list-style-type: none"> • Bonded Fiber Matrix (BFM): ○ Apply BFM using a hydraulic application machine (mulch and tackifier are pre-mixed in a single bag) in accordance with manufacturer's instructions. Do not apply immediately before, during, or after a rain event. ○ Note that cellulose fiber mulches alone may not perform well on steep slopes or in coarse soils.
Maintenance and Inspection	<ul style="list-style-type: none"> • Maintain an unbroken, temporary mulched ground cover throughout the period of construction when the soils are not being reworked. Inspect before expected rain and repair any damaged ground cover and re-mulch areas of exposed soil (e.g., weekly, or in compliance with the frequency specified in the project specific SWPPP, if applicable). • After any rain event, maintain all slopes to prevent erosion.

Pictures



Applying hydraulic mulch.



Close-up of bonded fiber matrix

**Corresponding
CASQA
Fact Sheet**

Fact Sheet EC-3



- What** Hydroseeding is a procedural BMP for the application of vegetation seed in a protective mixture for both soil and seed. The seed then sprouts, providing vegetation that provides additional soil erosion control (holds the soil in place and shields the soil from erosion). Hydroseeding material typically consists of a mixture of fiber, seed, fertilizer, and stabilizing emulsion.
- When**
- When temporary protection is needed until permanent vegetation protection can be established. Temporary vegetation should not be used for more than 3 to 6 months.
 - Avoid using hydroseeding during dry weather periods, unless supplemental irrigation is used.
- Where**
- Use on disturbed soil areas that must be re-disturbed following construction inactivity of 14 or more days.
 - Avoid use of hydroseeding in areas where the BMP would be incompatible with site conditions. These conditions include:
 - Slopes steeper than 1:3 vertical: horizontal. Steep slopes are difficult to protect with temporary seeding.
 - Traffic areas, where construction or other traffic would prevent seed sprouting or vegetation growth. Consider using soil binders instead (see BMP 4-05).
- How**
- Hydroseeding can be accomplished using a multiple-step (with straw mulch) or a one-step process (mixed with hydraulic mulch, hydraulic matrix, or bonded fiber matrix). When the one-step process is used to apply the mixture of fiber, seed, etc., the seed rate shall be increased to compensate for all seed not having direct contact with the soil. Confirm with your project Field Environmental Representative the appropriate seed mix to be used.
 - Prior to application roughen the slope, fill area, or area to be seeded with the furrows trending along the contours.
 - Apply straw mulch as necessary to keep seeds in place and to moderate soil moisture and temperature until the seeds germinate and grow.
 - Follow-up applications shall be made as needed to cover weak spots, and to maintain adequate soil protection.
 - Avoid over-spray onto the travel way, sidewalks, drainage channels and existing vegetation.
- Maintenance and Inspection**
- All seeded areas shall be inspected for failures and re-seeded, fertilized, and mulched within the planting season, using not less than half the original application rates. Any temporary re-vegetation effort that does not provide adequate cover must be re-vegetated.
 - After any rainfall event, maintain all slopes to prevent erosion.

Pictures



Applying hydroseed.

**Corresponding
CASQA
Fact Sheet**

Fact Sheet EC-4



What	Soil Binders is a procedural BMP for applying soil binder material to the soil surface to temporarily prevent water-induced erosion of exposed soils on construction or applicable operations and maintenance sites. Soil binders bind with the soil, creating a crust that sheds water and prevents the water erosion. Soil binders also provide temporary dust, wind, and soil stabilization benefits.
When	<p>Soil binders are typically applied to disturbed soil areas that require short-term temporary protection.</p> <p>Soil binders have the following application timing limitations:</p> <ul style="list-style-type: none"> • May not cure when low temperatures occur within 24 hours of application. • Soil binders generally experience spot failures during heavy rain and may need reapplication after a storm. • Some soil binders may not perform well during periods of low relative humidity.
Where	<p>Soil binders can be used for any disturbed soil area. Soil binders can often be incorporated into the work so they may be a good choice for areas where grading activities will soon resume or that experience light construction traffic.</p> <p>Soil binders have the following limitations for particular areas of application:</p> <ul style="list-style-type: none"> • Soil binders may not penetrate areas where soil surfaces are made up primarily of silt and clay, particularly when compacted. • Soil binders may not hold up well in areas of heavy pedestrian or medium to heavy vehicular traffic.
How	<p>Selection of soil binders should be approved by the project Field Environmental Representative after an evaluation of site-specific factors. Chemical soil binders must be on the SDG&E List of Approved Products. These approved soil binder products have low or no toxicity to aquatic organisms and wildlife and may not trigger the construction site sampling requirements of the CGP. Follow manufacturer's recommendations for application procedures and cleaning of equipment after use. Any onsite cleaning must use appropriate BMPs (BMP 2-02 "Material Use", 2-03 "Spill Control", 2-04 "Solid Waste Management", 2-08 "Liquid Waste/Drilling Fluid Management", and 3-03 "Vehicle and Equipment Washing").</p> <ul style="list-style-type: none"> • Prior to application, roughen embankment and fill areas. Track walking shall only be used where rolling is impractical. • Soil binders should not be applied during or immediately before rain events. Soil binders must be applied no less than 24 hours before rain to cure and dry and become fully effective. • Avoid over-spray onto paths, sidewalks, lined drainage channels, sound walls, and existing vegetation. • Do not apply soil binders to frozen soil, areas with standing water, under freezing conditions, or when the temperature is below 40°F during the curing period. • More than one treatment is often necessary, although the second treatment may be diluted or have a lower application rate. • For liquid agents: <ul style="list-style-type: none"> ○ Crown or slope ground to avoid ponding. ○ Uniformly pre-wet ground according to manufacturer's recommendations. ○ Apply solution under pressure. Overlap solution 6 to 12 inches.





How (cont')

- Allow treated area to cure for the time recommended by the manufacturer; typically at least 24 hours.
- Apply second treatment before first treatment becomes ineffective, using 50 percent application rate.
- In low humidity, reactivate chemicals by re-wetting according to manufacturer's recommendations.

Maintenance and Inspection

- Reapplying the selected soil binder may be needed for proper maintenance. Traffic areas should be inspected routinely.
- After any rainfall event, maintain all slopes to prevent erosion.

Pictures

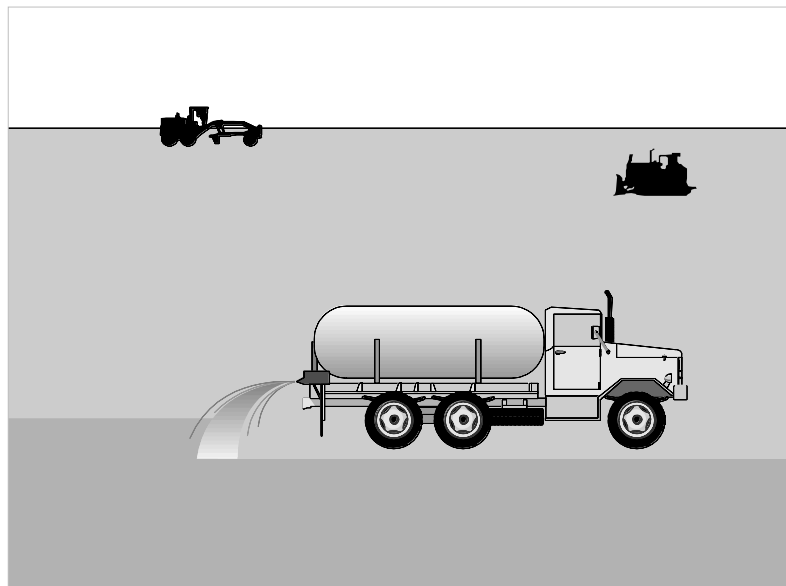

Corresponding CASQA Fact Sheet

Fact Sheet EC-5



What	Straw Mulch is a procedural BMP for the application of a uniform layer of straw to exposed soil surfaces to protect exposed soil from rain and wind erosion. Straw mulch consists of straw, and may incorporate a tackifier emulsion for stabilization of the mulch when used for protecting sloped areas of exposed soil.
When	<p>Straw mulch is used when:</p> <ul style="list-style-type: none">• Temporary soil stabilization surface cover is needed on disturbed areas until soils can be prepared for re-vegetation and permanent vegetation is established.• In combination with temporary and/or permanent seeding strategies to enhance plant establishment. Straw mulch typically lasts less than six months. <p>Limitation: There is a potential for introduction of weed-seed and unwanted plant material with straw. Certified Weed free rice straw must be used when it is important not to introduce unwanted plants.</p>
Where	Application of straw mulch is applicable to flat areas of exposed soil and areas of exposed soil with gradual slopes.
How	<p>Use tackifier to anchor straw mulch to the soil on slopes. Tackifiers act to glue the straw fibers together and to the soil surface, and the tackifier shall be selected based on longevity and ability to hold the fibers in place. Soil binders (tackifier) will generally experience spot failures during heavy rain events. A tackifier is typically applied at a rate of 125 pounds per acre. In windy conditions, the rates are typically 150 pounds per acre.</p> <ul style="list-style-type: none">• Crimping, punch roller-type rollers, or track-walking may also be used to incorporate straw mulch into the soil on slopes. Track walking shall only be used where other methods are impractical.• Avoid placing straw onto construction traffic ways, sidewalks, lined drainage channels, and existing vegetation.• Straw mulch with tackifier shall not be applied during or immediately before rain events.• Apply loose straw at a rate between 3,000 and 4,000 pounds per acre (lb/acre), either by machine using a straw blower or by hand distribution and provide 100 percent ground cover. Use a lighter application on flat surfaces and a heavier application on slopes.• The straw mulch must be evenly distributed on the soil surface.• Anchor mulch in place by "punching" it into the soil mechanically in lieu of using a tackifier. "Punching" of straw does not work in sandy soils.• Methods for holding the straw mulch in place depend on the slope steepness, accessibility, soil conditions and longevity. If the selected method is incorporation of straw mulch into the soil, then proceed as follows:<ul style="list-style-type: none">○ A tackifier acts to glue the straw fibers together and to the soil surface. Selection of a tackifier should be based on longevity and ability to hold the fibers in place. Application of a tackifier is typically at a rate of 125 lb/acre and 180 lb/acre in windy conditions.○ On very small areas, a spade or shovel can be used.○ On soil slopes which are stable enough, and gradually sloped to safely support construction equipment without contributing to compaction and instability problems, straw can be "punched" into the ground using a knife-blade roller or a straight bladed coultter, known commercially as a "crimper."



How (cont')

- On small areas and/or steep slopes, straw can also be held in place using plastic netting or jute. The netting shall be held in place using 11 gauge wire staples, geotextile pins or wooden stakes (BMP 4-07), “
- On small areas and/or steep slopes, straw can also be held in place using plastic netting or jute. The netting shall be held in place using 11 gauge wire staples, geotextile pins or wooden stakes (BMP 4-07, “Geotextiles, Plastic Covers, and Erosion Control Blankets/Mats”).
- Remove straw as necessary prior to permanent seeding or soil stabilization.

Maintenance and Inspection

- The key consideration in maintenance and inspection is that the straw needs to last long enough to achieve erosion control objectives.
- Reapplication of straw mulch and tackifier may be required to maintain effective soil stabilization over disturbed areas and slopes.
- After any rain event, inspect and maintain all slopes and straw mulch cover to prevent erosion.

Pictures



Straw mulch.

Corresponding CASQA Fact Sheet

Fact Sheet EC-6



What This Erosion Control and Soil Stabilization BMP is a procedural BMP for the installation of specific erosion control soil stabilization materials to control erosion from wind and water. These materials consist of:

- Geotextile blankets/mats,
- Plastic covers, and
- Natural/man-made material erosion control blankets.

Geotextiles are permeable fabrics typically made from polypropylene (plastic) or polyester that have the ability to protect the soil from erosion but are able to allow some water to reach and to drain the soil. Geotextile fabrics come in three basic forms: woven, needle punched, or heat bonded. Geotextiles also allow controlled rate and filtered drainage from a slope for slope moisture control, while providing slope reinforcement and protection.

Plastic Covers, such as Visqueen, are essentially impermeable and are used for immediate, temporary protection.

Erosion control blankets/mats are meant to protect exposed soil from wind and rain impact and reduce the speed at which water moves across the soil surface. These blankets can be made out of straw, coconut fiber, aspen fiber, jute, and polypropylene. Permeability varies according to material and material weave.

When

- Use blankets/mats when disturbed soils, especially on moderate to steep slopes, are difficult to stabilize or access. Due to wildlife concerns, consult with your project Field Environmental Representative for any restrictions on using these products on your project.

- Geotextile blanket/mats should be used when slope reinforcement may be required.
- Geotextile blankets/mats and natural fiber blankets/mats (depending on their permeability) are used when it is important to allow some water to reach the soil for seed germination or allow slope drainage for moisture control.

Where

- Blankets and mats are generally not suitable for excessively rocky sites or areas where the final vegetation will be mowed (because staples and netting can catch in mowers).

- Plastic results in 100 percent runoff, therefore, their use is limited to:
 - Covering small stockpiles.
 - Covering small graded areas for short periods, such as through an imminent storm event, until alternative measures may be installed.
 - Note the CGP discourages the use of plastic materials for cover when more sustainable alternatives can be used.

Blankets/mats should be used where there are:

- Steep slopes, generally steeper than 1:3 (vertical: horizontal).
- Slopes where the erosion hazard is high.
- Slopes and disturbed soils where mulches would need to be anchored.
- Disturbed areas where plants are slow to develop adequate protective cover.
- Channels with high flows.
- Channels intended to be vegetated.
- Slopes adjacent to water bodies or ESAs).

How For blankets or mat materials, proper site preparation is essential to ensure complete contact of the blanket or matting with the soil.



How (cont.)

- Grade and shape the area of installation.
- Remove all rocks, clods, vegetation or other obstructions so that the installed blankets or mats will have complete, direct contact with the soil.
- Prepare seedbed by loosening of topsoil.
- Seed the area before blanket installation for erosion control and vegetation. Seeding after mat installation is often specified for turf reinforcement. When seeding prior to blanket installation, all check slots and other areas disturbed during installation must be re-seeded. Where soil filling is specified, seed the matting and the entire disturbed area after installation and prior to filling the mat with soil.
- U-shaped wire staples, metal geotextile stake pins, or triangular wooden stakes can be used to anchor mats and blankets to the ground surface.
- Wire staples and metal stakes should be driven flush to the soil surface.
- All anchors should be 6 inches to 18 inches long and have sufficient ground penetration to resist pullout. Longer anchors may be required for loose soils.
- Installation on slopes - Consult the manufacturer's recommendations for installation. In general, these will be as follows:
 - Begin at the top of the slope and anchor the blanket in a 6 inch deep by 6 inch wide trench. Backfill trench and tamp earth firmly.
 - Unroll blanket down slope in the direction of water flow.
 - Overlap the edges of adjacent parallel rolls 2 inches to 3 inches and staple every 3 feet.
 - When blankets must be spliced, place blankets end over end (shingle style) with a 6 inch overlap. Staple through overlapped area, approximately 12 inches apart.
 - Lay blankets loosely and maintain direct contact with the soil. Do not stretch.
 - Staple blankets sufficiently to anchor blanket and maintain contact with the soil. Staples shall be placed down the center and staggered with the staples placed along the edges.
- Blankets and mats must be removed and disposed of prior to application of permanent soil stabilization measures.
- For plastic sheeting, it is important for the entire stockpile or exposed soil area to be covered completely, and the plastic firmly anchored with anchor objects spaced evenly along the entire perimeter so that wind, or storm water run-on, does not uncover the stockpile. Suitable anchors are gravel bags, sand bags, hay bales, or other non-polluting objects that can be safely handled.

Maintenance and Inspection

- Areas covered with temporary soil stabilization should be inspected routinely and before and after significant forecasted storm events. Any failures should be repaired immediately. Areas covered with temporary soil stabilization should be maintained to provide adequate erosion control. Temporary soil stabilization should be reapplied or replaced on exposed soils when greater than 10 percent of the previously covered area becomes exposed or exhibits visible erosion.
- If washout or breakage occurs, re-install the material after repairing the damage to the slope or channel.

Pictures



Several types of erosion control blankets.

**Corresponding
CASQA
Fact Sheet**

Fact Sheet EC-7



- What** Dust (Wind Erosion) control is a procedural BMP that consists of applying water or other dust suppressant to prevent or alleviate dust nuisance generated by construction and operations and maintenance activities.
- When**
- Dust control must be used whenever wind speed picks up dust and creates visual dust emissions. Dust control should be used at least initially on any project when exposed soil is subject to vehicle traffic and soil disturbance activities (e.g., dirt construction site, dirt access road traffic, grading, excavating, and soil stockpile generation, or soil removal from soil stockpiles).
 - Dust control must be implemented in accordance with local air quality requirements.
- Where** All construction and operations and maintenance activity sites where exposed soil is susceptible to wind erosion.
- How** Use the following measures as applicable:
- Appropriate methods of applying dust control (water, chemical dust suppressant, or soil covers and the means to apply it) should be available for construction or operation and maintenance activity sites with the potential to create dust.
 - Water applied for dust control should be applied evenly and in a manner that does not generate runoff.
 - Dust control methods should be approved by the project Field Environmental Representative. A construction permit or an agency rule may require specific control procedures.
 - Obtain prior approval to use any chemical dust suppressant from the project Field Environmental Representative. Dust suppressant chemicals must be on SDG&E's approved product list
 - Non-potable water should not be conveyed in tanks or drainpipes that will be used to convey potable water, and there should be no connection between potable and non-potable supplies. Non-potable tanks, pipes and other conveyances should be marked "**NON-POTABLE WATER - DO NOT DRINK.**" Approval for use of all non-potable sources of water must be obtained from the project Field Environmental Representative.
 - If reclaimed wastewater is used for dust control, the sources and discharge must meet California Department of Health Services water reclamation criteria and RWQCB requirements. Approval for use of reclaimed wastewater must be obtained from the project Field Environmental Representative.
- Maintenance and Inspection**
- Check areas protected to ensure coverage.
 - Reapply water, chemical dust suppressants, or maintain soil covers as necessary to maintain their effectiveness.





Pictures



Water being applied for dust control.

**Corresponding
CASQA
Fact Sheet**

Fact Sheet WE-1



- What** A diversion berm is a temporary berm of compacted soil used to direct runoff water to a desired location. A drainage swale is a shaped and sloped soil depression used to convey runoff to a desired location. Diversion berms and drainage swales divert off site runoff around the construction or operation and maintenance site, divert runoff from flowing onto stabilized areas and disturbed areas, and direct runoff into sediment basins or traps. A diversion berm or swale itself does not control erosion or remove or trap sediment from runoff.
- Limitations:
- Diversion berms may create disturbed areas and become construction equipment barriers.
 - Diversion berms must be stabilized immediately, adding cost and maintenance.
 - Diverted storm water may cause downstream flood damage.
 - Berms should not be constructed of easily eroded soils.
 - Regrading the site to remove the berm may add cost.
 - Other soil stabilization and sediment controls such as check dams, plastics, and blankets may be needed to prevent erosion in newly graded berms and swales.
 - Sediment accumulation, scour depression, and/or persistent non-storm water discharges can result in standing water suitable for mosquito production.
- When** Diversion berms and drainage swales are suitable for use, individually or together, where runoff needs to be diverted from one area to another. These BMPs may be used:
- To direct runoff away from disturbed areas or at the top of slopes.
 - To convey surface runoff down sloping land.
 - To divert runoff towards a stabilized watercourse, drainage pipe, or channel.
 - To intercept runoff from paved surfaces.
 - To divert sediment laden runoff into sediment basins or traps.
- Where** Diversion berms and drainage swales should be considered:
- At the top of slopes to divert run-on from adjacent or undisturbed slopes.
 - At bottom and mid-slopes to intercept sheet flow and convey concentrated flows.
 - Below steep grades where runoff begins to concentrate.
 - Along roadways and facility improvements subject to flood drainage.
 - Berms should not be used for drainage areas greater than 10 acres or along slopes greater than 10 percent. For larger drainage areas, more permanent drainage structures should be built in accordance with local requirements.
 - Drainage areas more than 5 acres should not drain to a temporary drainage swale. For larger drainage areas, use berms, or more permanent drainage structures should be built in accordance with local requirements.
- How** Berms and swales should not adversely affect adjacent properties and must conform to local floodplain management regulations. Obtain written



**How
(cont.)**

authorization from property owner to divert runoff onto another property.

- Care must be applied to correctly size and locate berms and drainage swales.
- Conveyances and outlets should be stabilized.
- Size to control flow velocity based on evaluation of the erosion risk, soil types, overtopping, flow backups, washout, and site drainage flow patterns.
- Install permanent berms and swales early in the construction process.

Diversion Berms:

- Compact all berms and provide positive drainage to an outlet.
- All berms should have 1:2 (vertical: horizontal) or flatter side slopes, and minimum 18-inch height, and minimum 24-inch top width. Wide top widths and flat slopes are usually needed for construction traffic crossings.
- Runoff should be conveyed to a sediment trapping device when the berm channel or the drainage area above the berm are not adequately stabilized.
- Temporary stabilization may be achieved using seed and mulching for slopes less than 5 percent and either riprap or sod for slopes greater than 5 percent. Stabilization should be completed immediately after installation/placement.
- If riprap is used to stabilize the channel formed along the toe of the berm, the following typical specifications apply:

Channel Grade	Riprap Stabilization
0.5 - 1%	4 inch Rock
1.1 - 2.0%	6 inch Rock
2.1 - 4.0%	8 inch Rock
4.1 - 5.0%	8 to 12 inch Riprap

- The riprap, recycled concrete, etc. should be pressed into the soil with construction equipment.
- Filter fabric may be used to cover berms in use for long periods.
- Construction activity on the earthen berms should be kept to a minimum.

Drainage Swales:

Standard engineering design criteria for small open channel and closed conveyance systems should be used. Unless local drainage design criteria state otherwise, drainage swales should be designed as follows:

- Place drainage swales above or below, not on, a cut or fill slope.
- Swale bottom width should be at least 2 feet, and the depth of the swale should be at least 18 inches. The swale side slopes should be 1:2 (vertical: horizontal) or flatter.
- Drainage swales should be at a grade of at least 1 percent, but not more than 15 percent.
- The swale must not be overtopped by the peak discharge from a 10-year storm, irrespective of the design criteria above.



How (cont.)

- Remove all vegetation and other objectionable materials and compact the fill material along the swale path.
- Stabilize all swales immediately after installation/placement. Seed and mulch swales with slopes of less than 5 percent and use riprap or sod for swales with slopes between 5 and 15 percent. For temporary swales, geotextiles and mats may provide immediate stabilization.
- Irrigation may be required to establish sufficient vegetation to prevent erosion.
- Do not operate vehicles across a swale unless a stabilized crossing is provided.
- Permanent drainage facilities must be designed by a California Registered Civil Engineer.
- At a minimum, the drainage swale should conform to predevelopment drainage patterns and capacities.
- Construct the drainage swale with a positive grade to a stabilized outlet.
- Provide erosion protection or energy dissipation measures if the flow out of the drainage swale can reach erosive velocity.

Maintenance and Inspection

- Inspect berms and drainage swales dams prior to, daily during, and after each storm event, and routinely throughout the construction activity (e.g., weekly, or in compliance with the frequency specified in the CGP, if applicable).
- Inspect BMPs subject to non-storm water discharges daily while the discharges occur.
- Inspect ditches and berms for washouts and erosion. Repair riprap, damaged linings, or soil stabilizers, and linings as needed.
- Inspect channel linings, embankments, and beds of swales and berms for erosion and accumulation of debris and sediment. Remove accumulated debris and sediment as needed. Removed sediment shall be incorporated in the project at appropriate locations or disposed of in accordance with federal, state and local requirements.
- Temporary conveyances should be completely removed as soon as the surrounding drainage area has stabilized or at the completion of construction.

Pictures

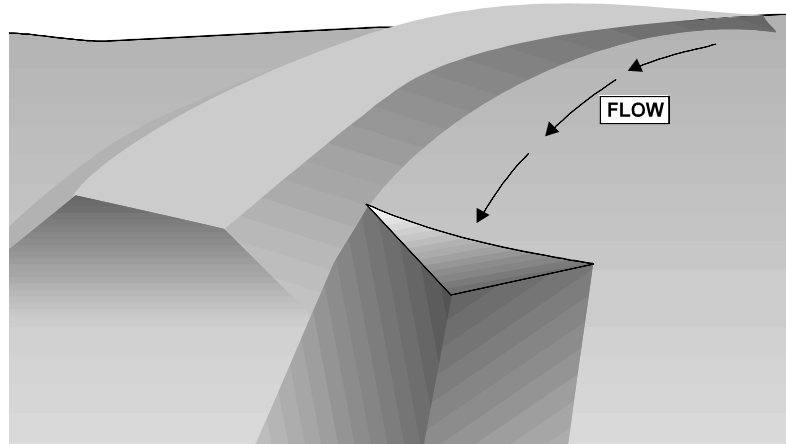

EROSION CONTROL AND SOIL STABILIZATION

Diversion Berms and Drainage Swales



**Corresponding
CASQA
Fact Sheet**

Fact Sheet EC-9



- What** Velocity dissipation devices are composed of rock, riprap, grouted riprap or concrete rubble, placed at the outlet of a pipe, channel, or waterbar to prevent scour and erosion caused by concentrated high velocity flows. There are many types of dissipation devices.
- Limitations:
- Large storms or high flows can wash away the outlet protection and leave the area susceptible to erosion.
 - Sediment captured by the outlet protection may be difficult to remove without removing the protection.
 - Outlet protection may negatively impact the channel habitat.
 - Grouted riprap may break up in areas of freeze and thaw.
 - With inadequate drainage, water may build up behind and break grouted riprap.
 - Sediment accumulation, scour depression, and/or persistent non-storm water discharges can result in standing water suitable for mosquito production.
- When** Velocity dissipation devices are suitable when discharge velocities and energies at the outlets of culverts, conduits, waterbars, or channels are sufficient to erode the next downstream reach.
- Where** Velocity dissipation devices should be considered:
- At outlets of pipes, drains, culverts, slope drains, diversion ditches, swales, conduits, channels, waterbars, etc.
 - At outlets located at the bottom of mild to steep slopes.
 - At discharge outlets that carry continuous water flow.
 - At outlets subject to short, intense water flows, such as flash floods.
 - At points where lined conveyances discharge to unlined conveyances.
- How** Depth of flow, roughness, gradient, side slopes, discharge rate, and velocity should be considered in the outlet design. Compliance to local and state regulations should be considered, particularly while working in environmentally sensitive streambeds.
- Determine the apron length and rock size gradation using the discharge pipe diameter and estimated discharge rate table below. Select the longest apron length and largest rock size suggested by the pipe size and discharge rate. Recommendations for rock size and length of outlet protection mat should be considered minimums. Use sound, durable, and angular rock.
 - Where flows are conveyed in open channels such as ditches or swales, use the estimated discharge rate for selecting the apron length and rock size. Flows should be the same as the culvert or channel design flow but never less than the peak 5 year flow for temporary structures planned for one rainy season, or the 10 year peak flow for temporary structures planned for two or three rainy seasons.
 - Install filter fabric, riprap, grouted riprap, or concrete apron at selected outlet. Install filter fabric or well-graded filter layer beneath the riprap apron. Riprap aprons are best suited for temporary use during construction. Grouted or wired riprap can minimize maintenance.
 - Rock outlet protection is usually less expensive and easier to install than concrete aprons or energy dissipaters, and serves to trap sediment and reduce flow velocities.



**How
(cont.)**

- Carefully place riprap to avoid damaging the underlying filter fabric.
 - Rock 4 to 6-inches may be carefully dumped onto the filter fabric from a maximum height of 12 inches.
 - 8- to 12-inch rock must be hand placed onto filter fabric, or the filter fabric may be covered with 4 inches of gravel, and the rock may be dumped from a maximum height of 16 inches.
 - Rock greater than 12 inches shall only be dumped onto filter fabric protected with a layer of gravel with a thickness equal to one-half the D_{50} rock size, with the dump height limited to twice the gravel protection layer thickness.
- Align apron with receiving stream and keep straight throughout its length. If a curve is needed to fit site conditions, place it in the upper section of the apron.
- Outlets on slopes steeper than 10 percent should have additional protection.

Pipe Diameter (in)	Discharge (ft ³ /s)	Apron Length (ft)	Min. Riprap D_{50} Diameter (in)
12	5	10	4
	10	13	6
18	10	10	8
	20	16	12
	30	23	16
	40	26	8
24	30	16	8
	40	26	12
	50	26	16
	60	30	8

**Maintenance
and
Inspection**

- Inspect velocity dissipation devices prior to and after each rain event, and daily during extended rain events throughout the construction activity (e.g., weekly, or in compliance with the frequency specified in the project specific SWPPP, if applicable). Initiate repairs related to a storm event within 72 hours of identifying the problem or as soon as possible but prior to the next predicted storm event, per the CGP.
- Inspect BMPs subject to non-storm water discharges daily while the discharges occur. Minimize standing water by removing sediment blockages and filling depressions.
- Inspect apron for displacement of the riprap and damage to the underlying fabric. Repair fabric and replace riprap that has washed away. If riprap continues to wash away, consider using larger material.
- Inspect for scour beneath the riprap and around the outlet. Repair damage to slopes or underlying filter fabric immediately.
- Temporary devices should be completely removed as soon as the surrounding drainage area has been stabilized or at the completion of construction.

Pictures

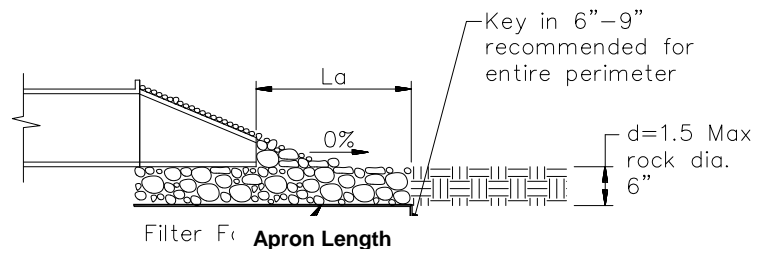
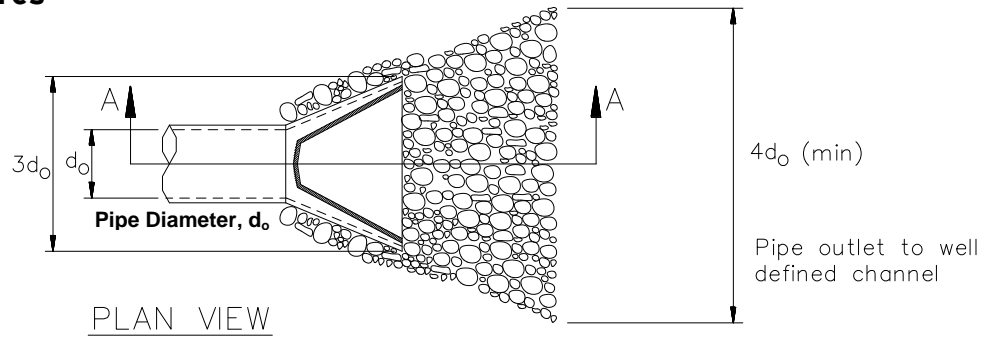

**Corresponding
 CASQA
 Fact Sheet**

Fact Sheet EC-10



What A slope drain is a pipe used to intercept and direct surface runoff or groundwater into a stabilized watercourse, trapping device, or stabilized area. Slope drains are typically used with diversion berms and drainage ditches to intercept and direct surface flow away from slope areas to protect cut or fill slopes. Slope drains prevent storm water from flowing directly down the slope by confining the runoff into an enclosed pipe or channel. The slope drain may be installed as a rigid pipe, such as corrugated metal, a flexible conduit, or a lined terrace drain with a top of a slope inlet and a bottom of a slope outlet.

Limitations:

- Slope drain sizing, installation, and maintenance is critical to minimize the potential for failure. Severe erosion may result when slope drains fail by overtopping, pipe separation, or other signs of erosion.
- Dissipation of high flow velocities at the pipe outlet is required to avoid erosion.
- Sediment accumulation, scour depression, and/or persistent non-storm water discharges can result in standing water suitable for mosquito production.

When Slope drains are suitable when:

- Concentrated runoff flow must be conveyed down a slope.
- Drainage is needed for top of slope diversion dikes or swales.
- Drainage is needed for top of cut and fill slopes where water can accumulate.
- Emergency spillway is required for a sediment basin.

Where Slope drains should be considered where:

- The drainage area is less than 10 acres per slope drain. For larger areas, use a rock-lined channel, or subdivide into areas of 10 acres or less, with each area is treated as a separate drainage.
- Drainage areas exceeding 10 acres must be designed by a California Registered Civil Engineer and approved by the agency that issued the grading permit.

How

- Permanent structures included in the project plans can often serve as construction BMPs if implemented early. However, the permanent structure must meet or exceed the criteria for the temporary structure.
- Slope drains and inlets must be securely attached to the slope and must be adequately sized to carry the capacity of the design storm and associated forces.
- Outlets must be stabilized with riprap, concrete, or other type of energy dissipater, or directed into a stable sediment trap or basin.
- Debris racks are recommended at the inlet. Debris racks are barriers used to collect debris that is too large to pass through the inlet. Debris racks located several feet upstream of the inlet can usually be larger than racks at the inlet, and thus provide enhanced debris protection and less plugging.



How (cont.)

- Safety racks are also recommended at the inlet and outlet of pipes to prevent a human body or animal from washing into the pipe and/or becoming trapped.
- Size to convey at least the peak flow of a 10-year storm. The design storm is conservative due to the potential impact of system failures. The pipe size may be computed using the Rational Method or a method established by a local municipality. Higher flows must be safely stored or routed to prevent any offsite concentration of flow or erosion. Maximum slope generally limited to 1:2 (vertical: horizontal) as energy dissipation below steeper slopes is difficult.
- Direct surface runoff to slope drains with interceptor dikes. Top of interceptor dikes should be 12 inches higher than the top of the slope drain.
- Slope drains can be placed on or buried beneath the slope surface.
- As a guide, temporary slope drains should not be sized smaller than shown in the following table:

Minimum Pipe Diameter (inches)	Maximum Drainage Area (Acres)
12	1.0
18	3.0
21	5.0
24	7.0
30	10.0

- Recommended materials include metal, plastic, or concrete pipe, either corrugated or smooth wall. The following types of slope drains are common:
 - Rigid Pipe: Also known as a pipe drop, the pipe usually consists of corrugated metal pipe or rigid plastic pipe. The pipe is placed on undisturbed or compacted soil and secured to the slope surface or buried in a trench. Concrete thrust blocks must be used when warranted by the calculated thrust forces. Collars should be properly installed and secured with straps or watertight collars.
 - Flexible Pipe: The pipe consists of a flexible tube of heavy duty plastic, rubber, or composite material. The tube material is securely anchored to the slope surface. The tube should be securely fastened to the metal inlet and outlet conduit sections with metal straps or watertight collars.
 - Section Downdrains: The section downdrain consists of a pre-fabricated, section conduit of half round or third round material, and performs similar to a flume or chute. The pipe must be placed on undisturbed or compacted soil and secured into the slope.
 - Concrete-Lined Terrace Drain: This concrete channel drains water from a slope terrace to the next level. These drains are typically specified as permanent structures and should be designed according to local criteria. If installed early, they can be construction slope drains.

How



(cont.) When installing slope drains:

- Install perpendicular to slope contours.
- Compact soil around and under entrance, outlet, and along length of pipe.
- Securely anchor and stabilize pipe appurtenances into soil.
- Check to ensure that pipe connections are watertight.
- Protect areas around inlet with filter fabric. A flared end section installed at the inlet will improve flow into the slope drain and prevent erosion at the pipe entrance. Use a flared section with a 6-inch minimum toe plate to help prevent undercutting. The flared section should slope towards the pipe inlet.
- Protect outlet with riprap or other energy dissipation device. Protect outlet of slope drains using a flared end section when outlet discharges to a flexible energy dissipation device.

Maintenance and Inspection

- Inspect slope drains prior to and after each storm event, and daily during extended rain events throughout the construction activity (e.g., weekly, or in compliance with the frequency specified in the project specific SWPPP, if applicable). Initiate repairs related to a storm event within 72 hours of identifying the problem or as soon as possible but prior to the next predicted storm event, per the CGP.
- Inspect BMPs subject to non-storm water discharges daily while the discharges occur. Minimize standing water by removing sediment blockages and filling depressions.
- Inspect outlet for erosion and downstream scour. If eroded, repair damage and install additional energy dissipation measures. If downstream scour is occurring, it may be necessary to reduce flows being discharged into the channel unless other preventative measures are implemented.
- Insert inlet for clogging or undercutting. Remove debris from inlet to maintain flows. Repair undercutting at inlet, and if needed, install flared section or riprap around the inlet to prevent further undercutting.
- Inspect pipes for leakage. Repair leaks and restore damaged slopes.
- Inspect slope drainage for accumulations of debris and sediment. Remove sediment from entrances and outlets as required. Flush drains as necessary; capture and settle out sediment from discharge.
- Ensure water is not ponding onto inappropriate areas (e.g. active traffic lanes, material storage areas, etc.).
- Pipe anchors must be checked to ensure that the pipe remains anchored to the slope. Install additional anchors if pipe movement is detected.

Pictures

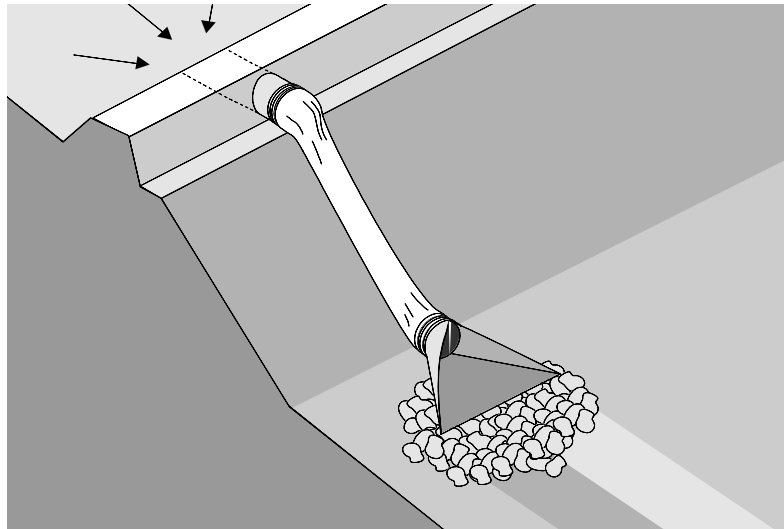

**Corresponding
CASQA
Fact Sheet**

Fact Sheet EC-11



What Streambank stabilization includes measures to reduce the discharge of sediment from streambanks with exposed or disturbed soil, or unstable banks. Streambank stabilization measures include preservation of existing vegetation, hydraulic mulch, hydroseeding, soil binders, straw mulch, geotextiles and mats, berms, and drainage swales, velocity dissipation devices, and slope drains. Streambank sediment controls include silt fences, fiber rolls, gravel bag berms, rock filters, and K-rail barriers, and padding. Each of these measures have different applications, limitations, and maintenance requirements for use as streambank stabilization.

Stream channels, streambanks, and associated riparian areas are dynamic and sensitive ecosystems that respond to changes in land use. Streams on the 303(d) list and listed for sediment may require numerous measures to prevent any increases in sediment load to the stream.

General streambank stabilization limitations:



- **Specific permit requirements or mitigation measures such as RWQCB 401 Certification, U.S. Army Corps of Engineers 404 permit and approval by the California Department of Fish and Game supersede the guidance in this BMP.**
- If numerical water quality standards are mentioned in any of these and other related permits, testing and sampling may be required. Soil disturbance activities in watersheds having streams listed as 303(d) impaired for sediment, silt, or turbidity, may require sampling to verify that there is no net increase in sediment load.

When When construction or operations and maintenance activities occur within stream channels and associated riparian areas.

Where Streambank stabilization procedures apply to all construction projects and operations and maintenance activities that disturb or occur within stream channels and their associated riparian areas.

How Planning should account for: scheduling; avoidance of wet in-stream construction; minimizing disturbance and construction time period; selecting crossing location; and selecting equipment.



- **Construction and operation and maintenance activities should be scheduled according to the relative sensitivity of the environmental concerns and will be different when working near perennial streams vs. ephemeral streams.**
- Minimize disturbance by using pre-disturbed areas, selecting the narrowest crossing location, limiting vehicle crossing trips, and minimizing the number and size of work areas. Plan work areas at least 50 feet from the stream channel.
- Avoid steep and unstable banks, highly erodible or saturated soils, or highly fractured rock.
- Select a project or work site that minimizes disturbance to aquatic species or habitat.
- Select equipment that reduces the amount of pressure exerted on the ground surface (less than 5 or 6 pounds per square inch where possible).



Maintenance and Inspection

- Inspect streambank stabilization BMPS prior to and after each storm event, and daily during extended rain events throughout the construction activity (e.g., weekly, or in compliance with the frequency specified in the project specific SWPPP, if applicable). Initiate repairs related to a storm event within 72 hours of identifying the problem or as soon as possible but prior to the next predicted storm event, per the CGP.
- Inspect BMPs subject to non-storm water discharges daily while the discharges occur.
- Inspect and repair equipment (for damaged hoses, fittings, and gaskets, etc.).

Pictures



Cobble or gravel armor used for streambank stabilization.

Corresponding CASQA Fact Sheet

Fact Sheet EC-12



What Soil preparation/roughening involves assessment and preparation of surface soils for BMP installation. This includes soil testing (for seed base, soil characteristics, or nutrients), or roughening surface soils by mechanical methods (including sheepsfoot rolling, track walking, scarifying, stair stepping, and imprinting) to prepare soils for additional BMPs or to break up sheet flow. Soil preparation can also involve tilling topsoil to prepare a seed bed and/or incorporation of soil amendments to enhance vegetative establishment. Various roughening techniques on slopes can result in a significant erosion reduction as compared to smooth slopes.

Limitations:

- Preparation and roughening must take place prior to installing other erosion controls (such as hydraulically applied stabilizers) or sediment controls (such as fiber rolls) on slope faces.
- In cases where slope preparation is minimal, erosion control/revegetation BMPs that do not require extensive soil preparation (such as hydraulic mulching and seeding applications) should be employed.
- Consideration should be given to the type of erosion control BMP that follows surface preparation, as some BMPs are not designed to be installed over various types of tillage/roughening.

When

- Soil preparation is most effective when used in combination with erosion controls. Soil preparation (i.e. tilling, raking, and amendment) is essential to proper vegetative establishment, and suitable in combination with any soil stabilization method, including rolled erosion control products (RECPs) or sod.
- Soil roughening is suitable for use as a complementary process to soil preparation for controlling erosion, and is not intended to be used as a stand-alone BMP. Soil roughening should be used with perimeter controls, additional erosion control measures, grade breaks, and vegetative establishment for maximum effectiveness. Soil roughening is referred to as track walking (sometimes called imprinting) a slope, where treads from heavy equipment run parallel to the slope contours and create terraces. Roughening is intended to only affect surface soils and should not compromise slope stability or overall compaction.

Where Soil preparation should be considered:

- Where vegetation is desired.

Soil roughening should be considered:

- Along any disturbed slopes, including temporary stockpiles, sediment basins, or compacted soil diversion berms and swales.
- Roughening should be used in combination with hydraulically applied stabilization methods, compost blankets, or straw mulch; but should not be used in combination with RECPs or sod because roughening is intended to leave terraces on the slope.

How Minimal materials are required unless amendments and/or seed are added to the soil. Most soil roughening/preparation can be done with standard construction equipment.



How (cont.)

Soil Preparation

- Where appropriate, soil should be prepared to receive the seed by disking or scarifying the surface to eliminate crust, improve air and water infiltration and create a more favorable environment for germination and growth.
- Based on soil testing, apply additional soil amendments (e.g. fertilizers, additional seed) to the soil to help with germination.

Cut Slope Roughening

- Stair-step grade or groove the cut slopes steeper than 1:3 (vertical: horizontal).
- Use stair-step grading on any erodible material soft enough to be ripped with a bulldozer. Slopes consisting of soft rock with some subsoil are well suited to stair-step grading.
- Make the vertical cut distance less than the horizontal distance, and slightly slope the horizontal position of the "step" in toward the vertical wall.
- Do not make individual vertical cuts more than 2 feet or 3 feet high in soft or rock materials, respectively.
- Groove the slope using machinery to create a series of ridges and depressions that run across the slope on the contour.

Fill Slope Roughening

- Place on fill slopes with inclinations steeper than 1:3 (vertical: horizontal) in lifts not to exceed 8 inches, and ensure that each lift is properly compacted.
- Ensure that the slope face consists of loose, uncompacted fill 4 to 6 inches deep.
- Use grooving or tracking to roughen the face of slopes, if necessary.
- Do not blade or scrape the final slope face.

Roughening for Slopes to be Mowed

- Slopes which require mowing should be flatter than 1:3 (vertical: horizontal).
- Roughen these areas to shallow grooves by track walking, scarifying, sheepsfoot rolling, or imprinting. Excessive roughness is undesirable when mowing is planned.
- Space grooves less than 10 inches apart, and not less than 1 inch deep, and perpendicular to the direction of runoff (parallel to the slope contours).

Roughening with Tracked Machinery

- Limit roughening with tracked machinery to soils with a sandy textural component to avoid undue compaction of the soil surface.
- Operate tracked machinery up and down the slope to leave horizontal depressions in the soil. Do not back-blade during the final grading operation.



**How
(cont.)
Maintenance
and
Inspection**

- Seed and mulch roughened areas as soon as possible to obtain optimum seed germination and growth.
- Inspect BMPs prior to and after each storm event, and daily during extended rain events throughout the construction activity (e.g., weekly, or in compliance with the frequency specified in the project specific SWPPP, if applicable). Initiate repairs related to a storm event within 72 hours of identifying the problem or as soon as possible but prior to the next predicted storm event, per the CGP.
- Check the seeded slopes for signs of erosion such as rills and gullies. Fill these areas slightly above original grade, then reseed and mulch as soon as possible.

Pictures



Sheepsfoot used for soil preparation

**Corresponding
CASQA
Fact Sheet**

Fact Sheet EC-15

REFERENCES

CASQA, 2009. California Stormwater Quality Association Stormwater Best Management Practice Handbook Portal: Construction, November 2009. <https://www.casqa.org>.

Sempra Energy, December 2002. Water Quality Construction Best Management Practices Manual.

ATS	Active Treatment Systems
Base	Construction and Operations Center
BFM	Bonded Fiber Matrix
BMP	Best Management Practices
Caltrans	California Department of Transportation
CASQA	California Stormwater Quality Association
CGP	California Construction General Permit
ES	Environmental Standard
ESA	Environmentally Sensitive Area
gpm	Gallons per minute
lb/acre	Pounds per acre
LID	Low Impact Development
NPDES	National Pollutant Discharge Elimination System
RWQCB	Regional Water Quality Control Board - there are nine Water Boards located throughout California that are responsible for enforcing water quality standards within their individual boundaries.
SDG&E	San Diego Gas & Electric
SUSMP	Standard Urban Storm Water Mitigation Plan
SWMP	Storm Water Management Plan
SWPPP	Storm Water Pollution Prevention Plan
SWRCB	State Water Resources Control Board - The State Board is responsible for protecting and preserving water quality and water rights in California.
Watershed	The total land area that contributes water to a river, stream, lake, or other body of water. Synonymous with drainage basin.
WDR	Waste Discharge Requirements

