

**PIPELINE SAFETY AND ENHANCEMENT PLAN (PSEP)
2016 REASONABLENESS REVIEW – A.16-09-005
WORKPAPERS
TABLE OF CONTENTS**

<u>Workpaper Page No.</u>	<u>Workpaper Chapter Title</u>
WP-Intro-1 - 10	<i>Introduction to Workpapers Supporting the Testimony of Rick Phillips, Chapter III, and Hugo Mejia, Chapter V</i>
WP-SCS-1 - 17	<i>Appendix A - Standard Construction Summary for Replacement, Hydrotest and PSEP Valve Projects</i>
WP-G- 1 - 10	<i>Appendix B -Glossary</i>
WP-III-A1 - A429	Pipeline Pressure Test/Replacement Projects
WP-III-B1 - B2	Facilities Lease Costs
WP-III-C1	Descoped Projects
WP-III-D1 - D3	Post Completion Cost Adjustments
WP-V-A1 - A204	Valve Projects
WP-IX-A1 - A2	Company Overheads
WP-XI-A1 - A9	Revenue Requirements

WP-Intro-1 - 10

**Introduction to Workpapers Supporting the Testimony
of Rick Phillips, Chapter III, and Hugo Mejia, Chapter V**

**SoCal Gas and SDG&E 2016 Reasonableness Review –
Workpapers supporting the testimony of Rick Phillips, (Chapter III),
and Hugo Mejia, (Chapter V)**

I. INTRODUCTION

The workpapers that follow describe the actions taken in each of the 41 SoCalGas and SDG&E projects to achieve the following objectives:

- 1) Fully comply with the directives of the Commission as set forth in Decision (D.)11-06-017;
- 2) Enhance public safety;
- 3) Minimize customer impacts; and
- 4) Maximize project efficiencies and record keeping of infrastructure investments for the benefit of our customers.

Each workpaper is organized to describe the important activities that occurred during each stage and the design choices that influenced costs for planning, managing and executing the PSEP Phase 1A pipeline replacement, pressure test and valve projects placed into operation by June 30, 2015 and reconciled costs except disallowances are as of March 31, 2016.

Also included at the end of this introductory section is **Appendix A**, Standard Construction Summary for Replacement, Hydrotest and PSEP Valve Projects and **Appendix B**, Glossary (that will assist in defining specific terminology used throughout the workpapers).

The list of Hydrotest and Replacement projects (Table 1) and Valve Enhancement projects (Table 2) for this 2016 Reasonableness Review is listed by the Phase 2 Work Order Authorization (WOA) date. The Phase 2 WOA estimate typically occurs in Stage 3 and signifies that the initial project scope has been defined, preliminary design has reached 30% and that the project is authorized to proceed through the remaining PSEP Seven Stage Review Process as described in testimony.

Table 1 – Pipeline Hydrotest and Replacement Projects for 2016 Reasonableness Review

Project Line	WOA Date	Project Type	Line Type	Miles / Feet
1005	2/5/2014	Replacement	Transmission	0.0286 mi (150.9 ft.)
1011	4/28/2014	Replacement	Transmission	0.0767 mi (405 ft.)
1013	3/13/2014	Replacement	Transmission	0.0265 mi (140 ft.)
1014	5/15/2014	Replacement	Transmission	0.0029 mi (15.4 ft.)
1015 (North & South)	5/12/2014	Test	Transmission	0.4094 mi
2000 West Sec (1,2,3)	7/17/2014	Test	Transmission	14.571 mi
2001 West A Sec (15,16)	8/5/2014	Replacement	Transmission	0.0059 mi (31.02 ft.)
2001 West B Sec (10,11,14)	7/9/2014	Test	Transmission	2.9394 mi
		Replacement		
2003 Sec (1,3,4)	7/9/2014	Test	Transmission	0.2492 mi
		Replacement		
235 West Sawtooth Canyon	9/4/2014	Replacement	Transmission	0.3239 mi
33-120 Section 2	12/18/2013	Replacement	Distribution	0.2790 mi
35-20-N	1/2/2013	Replacement	Distribution	0.0131 mi (69 ft.)
36-37	9/3/2013	Replacement	Distribution	0.0119 mi (62.6 ft.)
36-9-09 North Section 2B	6/2/2014	Test	Distribution	2.1540 mi
36-9-09 North Section 6A	6/2/2014	Test	Distribution	0.916 mi
36-1032 Sec (1,2,3)	12/10/2013	Replacement	Distribution	0.6532 mi
38-539	6/25/2014	Replacement	Distribution	2.613 mi
406 Sec (1,2,2A,4,5)	5/19/2014	Test	Transmission	1.166 mi
		Replacement		
407 (North & South)	1/31/2014	Test	Transmission	2.998 mi
41-30-A	7/9/2014	Replacement	Distribution	0.0203 mi (107 ft.)
45-120 Section 1	12/10/2013	Replacement	Distribution	0.553 mi
45-120X01	9/3/2013	Replacement	Distribution	0.0108 mi (57 ft.)
49-14	2/27/2014	Replacement	Distribution	0.0316 mi (166.8 ft.)
49-22	8/27/2014	Abandonment	Distribution	4.046 mi
49-32	11/21/2013	Replacement	Distribution	0.0629 mi (332 ft.)
PDR Storage Phase 4 and 5	12/17/2014	Test	Storage	0.2686 mi

*Line 235 West/Line 44-654/Line 235-335 Palmdale Valve presented with valves includes pipeline replacement.

Table 2 – Valve Projects for 2016 Reasonableness Review

Bundle	WOA DATE	Scope
Arrow & Haven	9/9/2013	1 valve
Bain St	9/10/2013	2 valves
Brea	5/2/2014	1 valve
Chino	9/26/2013	5 valves
Haskell	9/26/2013	2 valves
Moreno - Large	9/10/2013	1 FM
Moreno - Small	9/10/2013	1 valve/1 FM
Pixley	6/4/2014	3 valves
Prado	9/18/2013	5 valves
Puente	1/30/2014	2 CV's
Santa Fe Springs	9/15/2013	3 valves
SGV Fern & Walnut	5/22/2014	3 valves
Victoria	5/21/2014	3 valves/1 FM
Whitewater	9/18/2013	3 valves
Palmdale with L-235 and SL 44-654	9/1/13, 9/19/13, 12/17/13	6 valves with Transmission and Distribution Piping

II. PSEP Seven Stage Review Process

As explained in testimony, the Seven Stage Review Process sequences and schedules PSEP project workflow deliverables.¹ The Seven Stage Review Process consists of seven stages with specific objectives for each stage and an evaluation gate at the end of each stage to verify that objectives have been met before proceeding to the next stage.²

The PSEP workpapers describe the specific activities for each stage that are important to understand for that particular project and do not list every activity that is common to all projects. Below is a description of these common activities that occur within each stage that may not be discussed in the individual workpapers:

Pipeline Replacement and Hydrotest Projects

Stage 1 (Project Initiation) is where the Phase 1 WOA is initiated. The Phase 1 WOA is used to track costs for the early stage investigation and validation of Category 4 Criteria mileage and to fund enough preliminary project scoping and design to develop an initial cost estimate (Phase 2 WOA). The Project Initiation Stage is where mileage originally included for remediation may be

¹ The Seven Stage Review Process was implemented by the PSEP Organization beginning in the Second Quarter of 2013. Thus, PSEP projects that were initiated prior to that time did not follow this formalized process. A similar, but less formal, project execution methodology was employed in those instances.

² Certain stages are condensed or combined for valve and small pipeline projects.

decreased due to scope validation efforts, reduction in Maximum Allowable Operating Pressure (MAOP), or abandonment of lines that were no longer required from a gas operating system perspective.

Stage 2 (Test or Replace Analysis) is where SoCalGas and SDG&E analyze data for selection of testing or replacement and focus on achieving PSEP's four objectives. Project execution options are presented and considered prior to proceeding to the next stage.

Stage 3 (Begin Detailed Planning) is where a project execution plan is finalized, baseline schedules are developed, funding estimates are developed, and project funding is obtained. The preliminary design estimates or Total Installed Costs (TIC) are estimated in direct dollars. Based on the TIC direct estimate, a Phase 2 WOA is populated, which adds in the indirects. At the end of stage 3 a preliminary design of the project is complete.

Stage 4 (Detailed Design/Procurement) is where design and construction documents are completed, necessary permits and authorizations are attained, a construction contractor is selected, and pipeline materials are purchased, received, and prepared for turnover to contractors.

Stage 5 (Construction) is where construction contractors are mobilized and monitored to (1) document progress and compliance; (2) conduct testing; and (3) maintain project scope quality, budget, and schedule.

Stage 6 (Place into Service) is where commissioning and operating activities are performed to achieve completion certification for the project.

Stage 7 (Closeout) is where regulatory, contractual, archival activities are performed to close the project in an orderly manner and issue acceptance certificates.

Valve Projects

Stage 0 and 0.5 (Engineering Analysis) is where SoCalGas and SDG&E update the scope of the project and perform engineering analysis to determine how to effectively achieve the isolation objective.

Stage 1 and 2 (Project Initiation) is where SoCalGas and SDG&E verify proposed valve modifications, installations, and/or design changes based on field conditions.

Stage 3 (Planning) is where preliminary design efforts are conducted and a Stage 3 cost estimate is developed.

Stage 4 (Detailed Design /Procurement) is where detailed drawings are developed, the material procurement process is initiated, and permits to commence construction work are acquired.

Stage 5 (Construction) is where construction activities are initiated to complete the project; this includes coordination with Gas Operations to coordinate any required shut-ins and tie-in activities.

Stage 6 (Commissioning) is where valve projects conduct a commissioning process that includes a Site Acceptance Test. The Site Acceptance Test is necessary to obtain agreement from Gas Operations that the valve project is complete before turnover.

Stage 7 (Close-out) is where project documentation is completed. This includes completion drawings and material reconciliation for final records.

III. MAIN FUNCTIONAL PROJECT ACTIVITIES

There are several key design, management and execution actions and activities that occur within and across the various stages. As stated previously, the workpaper narratives present the relevant and notable project specific conditions and resultant actions that occurred at each stage. The key activities as described below occur in most of the projects and may or may not be described in detail inside each workpaper, but are activities that occur nonetheless.

Engineering and Design Engineering activity starts with analysis of pipeline attribute records, survey and mapping results and provides the foundation for a design that is cost effective and takes into account safety needs, system operating efficiencies, customer impacts and system capacity constraints. The workpaper narrative in Stages 2 and 3 highlights the considerations that shaped the final design decision when determining whether to test or replace a section of PSEP pipe. Through thoughtful and prudent design, savings were captured whenever possible. As addressed in testimony, examples of this are shared laydown yards with PSEP or other projects, coordination of construction schedules to have as few mobilizations and demobilizations as possible, etc. However, as unknown factors are revealed, complete or partial redesign may be necessary for reasons such as permit or land use restrictions, environmental constraints, customer impacts, traffic, system constraints, or pipe conditions identified once the pipe is exposed.

Cost Estimation activity begins in Stage 1 with approval of the Phase 1 WOA which reflects the estimated Stages 1-3 preliminary design, mapping and survey costs. In Stage 3, based on 30% design drawings, a TIC is generated using the version of the PSEP Estimating Tool that is currently available. The TIC costs are direct costs only and are the basis for the input into the Phase 2 WOA template. The Phase 2 WOA includes indirect costs, which provides a total loaded project cost estimate. The approval of the Phase 2 WOA signifies authority to continue execution of the project.

The cost elements included in the TIC cost estimate are consistently applied for Company Labor which estimates the costs for Utility employees charging directly to the project such as project managers, engineers, Land Services, Environmental, construction manager, and field support personnel required for services such as hot tapping and other safety services. Material Costs estimate reflect costs for

materials that SoCalGas and SDG&E intend to purchase such as pipe and fittings. Materials intended to be purchased by the construction contractor are included in the construction contractor estimate (either under Contract Costs or Other Direct Cost). Indirect Cost estimates are for incremental overhead loader costs that are applied to PSEP projects to account for costs that support the execution of PSEP projects but are not charged directly to each specific project through the PSEP GMA. Also included is interest that utilities are allowed to earn for funds used during construction for capital projects (AFUDC) and Property Tax for construction work in progress (CWIP) for capital projects.

The cost elements included in the TIC cost estimate for Contract Costs and Other Direct Costs represent costs for engineering, design, survey and mapping and construction such as contractor costs, inspection, and environmental abatement, etc. For these early projects, each estimator decided independently how to combine the cost elements into the category of Contract Costs and Other Direct Costs and it was not standard across the 41 projects. As discussed below, Actual Costs' element categories are standardized across all five categories. As such, the *Estimated* Contract and Other Direct Costs should not be compared to the *Actual* Contract and Other Direct Costs without the appropriate adjustments made so that it is a like for like comparison.

The PSEP estimating tool evolved and was modified over time as described in the testimony of Hugo Mejia (Chapter VII). The cost estimator incorporated market based costs when possible and estimators used similar PSEP project costs to the extent they were available.

Early PSEP projects that were managed by the Region used the SoCalGas Construction Management System (CMS) tool to estimate costs. This tool did not include PSEP specific overhead, loaders and PSEP GMAs.

Construction Contractor selection activity is described in Stage 4. It occurs once the Issue for Construction (IFC) design is completed and is based on 90% design drawings. Based on the IFC, a final scope of work is prepared and provided to the construction contractor on which to base their bid or cost estimate. Generally, the following methods were used to competitively select a construction contractor to promote reasonable costs and adherence to project budget (the construction contractor selection process for each project is discussed in workpapers):

- As described in Chapter II, Performance Partners were selected through a competitive process. Each Performance Partner project involved negotiating an agreed-upon Target Price Estimate (TPE). Implementation of the Performance Partner Program allows for competitive pricing of projects. In addition, other incentives associated with the program encourage Performance Partners to look for ways to further reduce costs once in construction.
- For shorter projects (typically less than 300 feet) that were managed by the Region, the Region signatory contractor was selected as the construction contractor. The Regions previously engaged in a competitive bid process to select their respective signatory contractors.
- Projects incorporated into a Pipeline Integrity (PI) project were managed by the same contractor as was selected by PI generally through a competitive bid process.

- In some instances, a project was single sourced to a particular contractor. This would be utilized on smaller projects to demonstrate a contractor’s capabilities on a type of job not typically performed by them (e.g. high pressure work, large diameter pipe).
- Valve projects utilized both mechanical and electrical contractors for construction. The valve mechanical work was included in the overall bid process for Performance Partners activities within a certain geographic region. Projects that had construction start dates after the implementation of the Performance Partners were assigned to the specific Performance Partner for mechanical contractor work. Projects that had construction start dates prior to the implementation of the Performance Partners were competitively bid.
- Electrical contractors for valve projects (controls, wiring, communication and electrical construction) were solicited by competitive bid from seven qualified electrical contractors for four geographic regions with three contractors selected as “Alliance” contractors. Alliance Contractors are assigned projects based on workload and geographic considerations similar to Performance Partners. Projects that had construction start dates prior to the implementation of the Alliance contractors were competitively bid.

Procurement of contracted services and materials, as described in more detail in testimony, is managed by SoCalGas and SDG&E’s Supply Management team. When possible PSEP acquires materials by aggregating material needs (bulk buy) from many projects thereby, making periodic buys for larger quantities of material. In some instances and when possible, items are transferred between projects when materials are not received on time to avoid added costs for expedited delivery and to avoid delays. See Chapter III (Phillips) at Section VI.

Construction Activity is further detailed in Appendix A to these workpapers and provides a description of the large variety of field activities that may take place on a PSEP pipeline replacement, hydrotest or valve project. In the workpapers, only the notable activities were discussed that influenced decisions about scope, schedule and budget. The construction activities primarily occur in Stage 5 however, there are field activities that may occur in other stages of a project as well.

Most of the pipeline replacement and hydrotest projects along with many of the valve projects were located in dense urban environments which greatly added to the complexity of the construction activities. Some examples of urban construction challenges are limited space for large equipment to operate or a laydown yard to be established, congested construction areas, substructure conflicts, unknown substructures beneath street surfaces, highly traveled roadways requiring extensive traffic control and/or reduced working hours, complicated railway or highway work areas, required night work and noise abatement activities, etc.

Scheduling of required personnel and equipment is also extremely challenging for PSEP projects. Some of the scheduling can be completed ahead of project construction, but some scheduling conflicts will need to be resolved in real-time. The following highlights just a few considerations that have to be factored into each project:

- Equipment – needed to be delivered such as pressure control and tapping equipment, X-ray and NDE testing set-ups, etc.
- Local operations personnel – perform gas handling, stand-by work, tie-in work, etc. Planned PSEP projects may have to be rescheduled to accommodate last minute, higher priority Region work.
- Gas Control – may require small windows for shutting in a pipeline to ensure reliable service for potentially impacted customers.
- Numerous contract crews, inspectors, and oversight personnel - which are required to complete the project, must coordinate their work in a synchronized fashion with many activities dependent on other activities to be completed before or during said operation.
- While all individual projects have these orchestration challenges, scheduling issues are compounded for PSEP because of the number of projects that are scheduled one right after another. Delay of one project causes a significant amount of effort to reschedule downstream projects.

The following is a high-level summary of the PSEP pipeline replacement construction activities (see Appendix A – Standard Construction Summary for detailed descriptions):

1. Permits – usually involve long lead times, negotiations of conditions, and last-minute requirements that have to be incorporated into project plans. There is normally site visits associated with the permit applications and job walks with agency inspectors. Inspectors can change permit conditions.
2. Base mapping, surveying and locating activities – determines the existing substructures (when known) over the in the path of the project, the jurisdictions and/or land owners, determines/confirms the location and depth of other known substructures in the proposed path that will need to be designed around, right of way constraints, customer notifications, etc.
3. Laydown yard/Field construction office – preps the lay-down yard and construction area for work.
4. Trenching and excavating – work is typically extensive for PSEP projects. Various areas on the pipeline must be exposed during the construction process such as tap locations (feeds off the pipeline that will need to be isolated or provided with an alternative source of supply), and features identified for removal and/or replacement. Some of the required excavations are large due to the nature of the work and the type of equipment required such as in boring operations. Boring operations occur to transverse freeways and highways, railroads, environmentally sensitive areas, and congested intersections.
5. Pipeline bending and welding – are different activities that occur directly to/on the pipe. Each segment installed may need to be bent to match up to existing pipe, fit into spacing requirements, etc. Welding which joins pipeline sections together is a highly inspected and regulated process. There are specific crews that perform each of these actions and each takes considerable time, engineering and skill to complete.

6. Non-destructive testing – After welds are complete they are quality checked using non-destructive testing techniques. involves radiographic inspection of identified welds as the welding operation proceeds.
7. Field Coating – is completed after welding takes place or anywhere exposed metal is present. There is a specific crew typically dedicated to perform this work with quality control and inspection activities occurring after each coating section is completed.
8. Lowering the pipe into the trench - requires large equipment and skilled operators to complete.
9. Backfilling – is a process that occurs after the pipeline is ready to be covered and has specific requirements and steps necessary to protect the pipe and meet compaction requirements.
10. Hydrotests – can occur with the existing pipe in the ground or in the lay-down yard depending on the amount of pipe to be installed and the design specifications. The drying process can be extensive for the longer sections of pipelines, requiring many pigging runs. Pipeline pigging equipment and air movers are used to decrease the water content to an acceptable level to prevent corrosion.
11. Final tie-in and commissioning – involves connecting the pipeline to the existing main pipeline as well as any taps, laterals and crossovers. For replacement projects, during this time work will also begin to abandon the old parallel pipeline.
12. Clean-up and restoration – involves putting the lay-down yard and construction area as close to original conditions as possible. Paving of streets and removal of construction equipment occurs. The permit conditions are satisfied.

The PSEP hydrotest projects have a few unique project characteristic as compared to replacement projects such as the removal/replacement of several pipeline features in order to remove threat as and/or make the line piggable as well as additional steps for isolation. Also there may be the need for CNG/LNG support for an extensive period of time to supply individual customers fed off the pipeline being tested.

Field Conditions and Field Design Changes are described in Stage 5 and are the result of unknown conditions or circumstances that are encountered once construction has begun. These include environmental conditions that require abatement, pipe conditions that are revealed once the trench is dug and/or the pipe is exposed, weather delays, damaged or delayed material deliveries, security needs, changes to permit conditions, etc.

Actual Loaded Costs are described in Stages 6-7. For PSEP, direct costs also include PSEP General Management and Administrative Costs (PSEP GMA). These PSEP GMAs are support costs that are not attributable to specific projects but are incurred to build out the foundational elements of the PSEP program and to support the on-going management and administrative aspects of PSEP; including the organization, departments, processes and procedures, which support project-specific activities. The actual costs activities are standardized as follows:

- **Company Labor:** reflects the costs for Utility employees charging directly to the project such as project managers, engineers, Land Services, Environmental, construction manager, and field support personnel required for services such as hot tapping and other safety services
- **Contract Costs:** reflect construction services such as construction contractor, construction management, construction inspection services, radiographic inspection services, specialized material traceability services, contamination mitigation, etc.
- **Materials:** reflect costs for materials that SoCalGas and SDG&E purchased such as pipe, fittings and water. Materials intended to be purchased by the construction contractor are included in the construction contractor costs under Contract Costs.
- **Other Direct Costs:** reflect planning and design services, engineering, environmental services, land use and permitting fees, and project support, such as survey, mapping and miscellaneous expenses.
- **Indirect Costs:** reflect costs for incremental overhead loaders such as those activities and services that are associated with direct costs, such as payroll taxes and pension and benefits. Also included is interest that utilities are allowed to earn for funds used during construction for capital projects (AFUDC) and Property Tax for construction work in progress (CWIP) for capital projects.

Variances between the actual and estimated costs are caused by a variety of factors but most typically are the result of the estimate being based on the preliminary design and an early estimating process and tool. This is evidenced by the difference between the Construction Contractor's TPE and the Stage 3 TIC and frequent underestimation of other construction services. Unforeseen and unplanned field conditions also contribute to variances between the estimate and the actual costs. The relevant explanations for each project's variance are provided inside each workpaper.

This concludes the workpaper introduction which describes how the workpapers are organized and the general activities that take place on each project that may not be directly spoken to in each workpaper. The following appendices A and B will provide more detailed information on replacement and hydrotest construction activities along with the terms that are used within the workpapers that are found in the Glossary.

WP-SCS-1 - 17
Appendix A -Standard Construction Summary
for Replacement, Hydrotest and PSEP Valve Projects

APPENDIX A

Standard Construction Summary for Replacement, Hydrotest and PSEP Valve Enhancement Projects (Construction Primer)

The following information provides an overview of the typical construction activities that occur during SoCalGas and SDG&E PSEP pipeline replacement, hydrotest and valve (retrofit or new installation) projects.

Most pipeline and valve enhancement projects submitted in this application were constructed in highly dense urban areas which greatly increased the complexity of the construction work performed. These projects generally occurred in heavily traveled roadways that required extensive traffic control plans (see Figures 1 and 2). These construction locations are typically crowded with other utility substructures causing extensive research work to identify the substructures prior to construction, and then to causing frequent redesigns when unknown substructures are discovered after excavation during construction. (see Figure 3).

Due the importance of high-pressure transmission lines to system reliability, these projects require extensive schedule coordination with the local operations personnel to minimize customer impacts, execute gas handling, and complete stand-by and tie-in operation. There are also frequent project schedule accommodations that have to be made for Gas Control to support system reliability. Some of the capacity constraints can be planned for ahead of time and some need to be mitigated in real-time. Such rescheduling can have significant impacts on a project's overall productivity and efficiency.

In addition to the scheduling of local personnel and Gas Control, there is also a tremendous amount of effort that takes place to schedule and coordinate the required equipment (pressure control, Non-Destructive Testing (NDT), tapping equipment, etc.), construction contract crews (pipeline, electrical, mechanical, etc.), inspectors (NDT, environmental, safety etc.) and our oversight personnel (PMO support, Contract Administrators, etc.). There are numerous individuals with required technical knowledge, trade licenses, and certifications that are essential to producing a successful project that meets the objectives of PSEP.

Lastly, it should be noted that there are some projects that may differ in the general activities described below, depending on the unique characteristics of that job with most of these conditions being discussed as applicable in the individual work papers.

This first section describes the typical activities of a replacement project. The following sections will discuss the differences seen in hydrotest and PSEP valve enhancement projects as compared to a replacement project.

Replacement project

1. Permits – Typically Stages 3 or 4

One of the initial construction activities that affects project decisions is the securing of permits. The projects are in a variety of locations: congested urban areas, highways/freeways, railroads/light rails, bridges, environmentally and culturally sensitive areas, coastal zone, commercial centers, private land, hillsides, airport zones, etc. and as such, there are usually many permits required for a project. Each area will present unique requirements that are necessary for successful and safe construction which also must follow the specific requirements such as requiring night work (see Figure 4) as stated in each of the specific permits pulled for a project. Permits may take many months to secure and the requirements of the permit may not be known until

APPENDIX A

construction is about to begin. The permits may be local, state, or federal permits and clearances and they address all natural resources — land, air, water, vegetation, and wildlife — as well as the interests of the general public such as noise permits. Some of the most common agencies involved are local municipalities, Caltrans, Local tribal organizations, U.S. Army Corps of Engineers, Bureau of Land Management, environmental agencies, etc.

2. Surveying and Locating – Stages 3 or 4

Surveying and locating activities will typically take place during Stages 3-4 and determine the right of way (ROW) and pipeline location. The ROW is a narrow strip of land (public or private property) that contains the pipeline(s) and is where all onsite construction activities occur. Before any construction activities can begin, survey and locate & mark crews carefully survey and mark out the construction right of way for the existing pipeline and other substructure locations.

Since it is critical that the exact pipeline location and substructures are known prior to the start of construction, potholing is also completed typically during Stage 4, but there are times when this activity cannot start until Stage 5 (construction). Potholing involves excavating a small hole over the pipeline to validate the location of an existing substructure.

Surveying and locating activities help to determine what will be needed for the temporary construction easements, possible substructure conflicts within the desired replacement location, and other issues that will need to be accounted for in the project design.

In Stage 4, the land acquisition team is evaluating nearby locations for a lay-down yard and field construction office which will stage the equipment, material, fabrication space, water for hydrotests, work trailer, etc. for several weeks. Ideally, the yard will be at least 50,000 square feet or about the size of a football field (See Figure 5).

Lastly, during Stages 3 and 4, affected customers are identified and communication materials are generated and sent out which notify customers of the upcoming construction activities in the area. This notification takes place earlier enough in the process so as to allow for customer input and changes to construction as needed.

3. Clearing and Grading Construction and Lay-down Yard - beginning Stage 5

At the beginning of Stage 5 (Construction) the clearing/grading activities typically take place for projects in the non-paved locations; a few required extensive work due to work being located on hillsides. Clearing is the removal of all brush from the construction work area. Grading is required to provide a relatively level surface to allow safe operation of the heavy equipment. It should be noted before any construction activity takes place an environmental inspection may be required of the laydown yard and the pipeline construction area.

4. Trenching and Excavating – Stage 5

Trenching and excavating activity takes place in Stage 5 (Construction). The trenching operation in pavement begins with a saw-cutting crew which cuts the pavement for excavation. Once the pavement is removed from the area, the trenching can begin. The trenching crew typically uses a backhoe to dig the replacement pipe trench. The trench is excavated to a depth that provides sufficient cover over the pipeline after backfilling. Typically, the trench is about 4 to 6 feet wide in stable soils and at least 5-feet deep (depends on the pipeline's diameter and DOT Class location to actual depth). This depth allows for the required minimum 36 inches of cover.

Many pipelines are located at a depth which require elaborate shoring systems to be installed for construction. The shoring is necessary when the excavation is more than 5 feet deep or is in sandy soil conditions (see Figure

APPENDIX A

6). The shoring can limit the work area due to beams and other structures that obstruct the construction process which slows down production (see Figure 1). An example of why greater pipeline depth is needed is a railroad crossing or storm drain conflict.

Given the work that needs to take place on the existing pipeline, the excavation may require hand-digging over the gas pipeline per code to expose the pipe and other potential utility substructures in the area. The hand-digging process can be labor and time intensive. For example, if the trench that the pipeline must be installed within is running laterally with another utility structure and the distance is under the legal threshold for mechanical excavation, the entire length must be hand excavated.

There are also many requirements that have to be met during the excavation process that are governed by the various permits issued for a project. For example, when excavating in traveled roadways, which was the case for nearly all 41 projects, steel plates will be needed to cover the open trench at the end of each day. The process of moving the plates on the trench and welding them together at the end of the day and then removing them each morning takes additional time that may decrease productivity depending on the available working hours set by the permitting agency.

Some installations require a bore operation when the pipeline needs to go under a structure and an open trench cannot be dug, for example for crossing a freeway/highway, or railroad, or to avoid disrupting traffic across a busy intersection. In this case, there is only an excavation at the start and end of the bore route; however, these bore pits are typically 30 feet x 15 feet and at a minimum depth of 20 feet (often times greater). This activity requires extensive bell-hole preparation and is a complicated process that necessitates a specialized crew and equipment (see Figures 7 and 8).

Often, each replaced pipeline has taps that feed an individual customer or a regulator station which need to be connected to the new pipeline once put into service. Each tap location requires an excavation which is on average approximately 5 feet x 8 feet and takes a crew approximately 1 day per hole to excavate depending on the soil conditions (shoring may also be needed). Those excavations will be plated and left open until the new pipeline section is tested and gassed up. Then these tap connections can be completed and backfilled.

Lastly, there are some municipalities that require the existing pipeline to be removed and the new pipeline to be installed in the same location. This also might be necessary if the pipeline right of way is not large enough for the replacement pipeline. This removal step can greatly add to the complexity and time for the project.

5. Pipeline Laying, Bending, Welding - Stage 5

The pipe sections, fittings and other pipeline components are laid out on the job site for installation as construction proceeds. In order to follow the correct route the pipe's direction is changed by either bends or welding in segmented ells (see Figure 9) .In some cases the joints are welded together and placed on temporary supports (see Figure 10). The pipe crew and a welding crew are responsible for the welding process. The pipe crew typically uses special pipeline equipment called side booms to pick up each joint of pipe, align it with another joint, and make the first part of the weld (a pass called the stringer bead). Additional filler passes are made by welders who immediately follow the stringer bead. There could be different welders for the different welds needed: stringer, hot-pass, and capping welders make up the typical welding crew, and they are often followed by tie-in welders.

APPENDIX A

6. Non Destructive Evaluation (NDE) - Stage 5

As part of the quality assurance process, each welder must pass qualification tests (Operator Qualification) to work on a particular pipeline job, and each weld procedure must be approved for use on that job in accordance with federally adopted welding standards.

The welds undergo visual and radiographic inspection (a.k.a. X-ray), as outlined in 49 CFR Part 192 by qualified technicians and inspectors. The technicians take X-rays of the pipe welds to ensure that the completed welds meet federally prescribed quality standards. The X-ray technician processes the film in a small, portable darkroom at the site. If the technician detects any unacceptable flaws, the weld is repaired or cut out, and a new weld is made as per code requirements.

7. Lowering Pipe into the Trench - Stage 5

Depending on the length of pipe to replace, lowering the welded pipe into the trench demands close coordination and skilled operators (see Figure 9). Using a series of sidebooms (tractor designed to move pipelines into place), operators simultaneously lift and carefully lower the welded pipe sections into the trench. The bottom of the trench is shaded with at least 6 inches of sand to protect the pipe and coating from damage. Lastly, cathodic protection test stations may be installed on the pipeline before backfilling.

8. Field Coating - Stage 5

Pipelines are externally coated to prevent moisture from coming into direct contact with the steel and causing corrosion. Typically, coated pipelines are delivered with uncoated areas three to six inches from each end to prevent the coating from interfering with the welding process. Once the welds are completed, a coating crew coats the remaining portion of the pipeline. Prior to this coating application, the coating crew thoroughly cleans the bare pipe with a power wire brush or a sandblast machine to remove any dirt, mill scale, or debris. The crew then applies the coating and allows it to dry. Once dry, the coating of the pipeline is inspected to ensure it is free of defects: it is electronically inspected, or “jeeped,” for faults or voids in the epoxy coating and visually inspected for faults, scratches, or other coating defects.

9. Backfilling and Paving - Stage 5

After all welds have passed NDE, coating is completed and passes inspection, and survey crews record the location of the pipe and various valves/fittings, crews begin the backfilling process. As with previous construction crews, the backfilling crew takes care to protect the pipeline and coating by using a minimum of 12 inches of zero-sack slurry (sand and water mixture) on top of the top pipe. Then the remainder of the backfill material is placed over the pipe. The final step is paving.

10. Hydrostatic Testing - Stage 5

Depending on the varying elevation of the terrain along the pipeline and the location of available water sources, the pipeline may be divided into sections to facilitate the test. Each section is filled with water and pressured up to DOT requirements and held for a specified period of time to determine if the pipeline meets the design strength requirements and if any leaks are present (see Figures 11 and 12 for hydrotest set ups). Once a section successfully passes the hydrostatic test, water is emptied from the pipeline and the pipeline is dried to ensure that no water is present when natural gas begins to flow.

The drying out of the pipeline is completed using large compressors and foam tools (pigs). A pig launcher and receiver are installed at the ends to facilitate this process. The team will continue to pass the pig through the system until the desired dew point is reached as prescribed by engineering. Once achieved, the final tie-ins and commissioning activities can commence. This drying process usually takes 3 days, more or less depending on the length and geometry of the pipeline.

APPENDIX A

The used water is tested by environmental services for disposal purposes. Containers such as Baker Tanks are used to store the water before disposal while water testing results are being evaluated (see Figures 11, 12, and 13). Filtration equipment is used to remove organic and inorganic material to permit disposal levels. The water may be disposed of at a sewer, transported to a disposal facility via a truck or provided to a third party for non-potable reuse. How the water is disposed often times depends on permit requirements.

11. Final Tie-in and commissioning - Stage 5 and 6

Following successful hydrostatic testing and drying process, the final pipeline tie-ins are made and inspected (see Figure 14). The line is then odorized which is a process that will take up to 2 days or more to complete. After odorization is achieved, the tie-in process is completed with flow being opened to all taps. Any customers who were being fed by CNG/LNG have their service switched to being fed from the new pipeline.

The process for the abandonment of the original line also needs to take place. It begins by purging, isolating the ends and taps, and permanently decommissioning the line which could take a few days to complete.

12. Cleanup and Restoration - Stage 5 and 6

The final step in the construction process is to restore the street, right-of-way, easement land and lay-down yard as closely as possible to its original condition. This step involves cleaning up the lay-down yard, completing the paving repairs or land restoration as required by the issued permit or land owner. Careful attention is paid to ensure future erosion issues are addressed for non-paving involved installations.

This next section describes the hydrotest project activities as they differ from a pipeline replacement project.

Hydrotest Project

The trenching/excavating activity for a hydrotest project will involve exposing the pipeline to be tested as follows:

- a. Identified pipeline features will be removed. The removal process in general will also involve welding and NDE (see Figure 15).
- b. All non-piggable pipeline features will be removed.
- c. All pipeline features that cannot be pressure tested will be replaced/removed.
- d. All tap locations (customer lines, regulator station taps, etc.) that are off the main line will be excavated because they need to be isolated before a hydrotest.
- e. Each end of the project will be exposed to install test heads. This will require a minimum of a 10 foot x 20 foot bell hole.

There is a small amount of replacement work during a hydrotest project that is necessary to isolate the pipe and install the test heads. This replacement activity requires the following:

- a. The small section of pipe is removed at each end.
- b. The non-tested line must be welded with a cap that will be cut out after testing is completed.
- c. The test heads are welded into place and NDE follows.
- d. The pipe is hydrotested.
- e. The test heads are cut out and the pig launcher/receiver is installed. The drying process takes place after water is removed.

APPENDIX A

- f. The pig launcher/receiver is removed and a new tested section of pipe is installed. All taps and main line ties are completed using the welding process.

Lastly, since the pipeline is being taken out of service, there could be CNG/LCG activities: deliveries, installation, management and eventually removal required for the individual customers fed off the pipeline being tested (see Figure 16).

See the following link for a video describing the process.

<https://www.youtube.com/watch?v=IRFWeTRAcCU>

The following section describes the PSEP valve enhancement project activities (retrofits or new valve installations/stations) as they differ from a pipeline replacement project.

PSEP Valve Enhancement Project

- Some work will occur on SoCalGas and SDGE property which will not always necessitate obtaining a permit. The permits that are obtained may be for assets underground, aboveground or both. The valve work may involve obtaining new ROW or easements agreements for installations in new locations. The aboveground work could be extensive with the commissioning of buildings and other structures to house communications, data panels, etc. (see Figure 17)
- For the valve enhancement projects submitted in this application, they are located in both city streets and in the rural areas. The urban valve locations typically require additional assembly space which is frequently larger than the given ROW rights; and therefore, land acquisition activity presents a greater challenge as compared to pipeline work in the streets (see Figure 18).
- The survey and locating activities will include potholing to confirm the depth and alignment of the pipe/valve assembly. Also, the distances of the valve/pipe from sidewalks or other areas will be determined. This information is critical to the vault and actuator designs because of the varying heights and horizontal space requirements for the equipment. At times, these activities may determine whether a pipeline needs to be relocated to accommodate a valve installation/retrofit. Lastly, depending on the type of project installation, land may need to be purchased in order to accommodate facilities such as a large valve station that will include small buildings, communication installations, and other structures.
- Each valve enhancement project involves significant excavation work that differs from hydrotests or replacement projects. Below is a list of possible excavations that may take place on a valve enhancement project:
 - a. Expose the existing valve assembly (all sides) and for the installation of a new vault.
 - b. Install a new valve location and associated vault.
 - c. Remove pipeline features as required.
 - d. Bring in new power/communications lines.
 - e. Install gas control gas piping for sensing functions.
 - f. Prepare the foundation for retaining wall installations for cabinets or to secure the entire facility.
 - g. Install line break cabinets, SCADA buildings, and antennae poles.
 - h. Install looped grounding systems in the valve station.

APPENDIX A

- Hydrotesting will occur on any new valve assemblies. For some projects the test will take place aboveground in the lay-down yard and for other projects it will occur with the main-line pipe which will involve test heads and pig-launcher/receiver assemblies.

See the following link for a video describing the process.

<https://www.youtube.com/watch?v=Fpv-ENrrHNI>

This concludes the overview of the general construction activities that take place with PSEP replacement, hydrotest and valve enhancement projects.

Note: the following photos were taken on PSEP jobs performed by SoCalGas and SDGE.

APPENDIX A

Figure 1: Trenching in Urban Location



Figure2: Lowering Pipe in Congested City Area



APPENDIX A

Figure 3: Installing Pipe in Trench with Existing Substructures



Figure 4: Night Work Construction Site



APPENDIX A

Figure 5: Construction Laydown Yard



Figure 6: Shoring



APPENDIX A

Figure 7: Jack and Bore Pit



Figure 8: Jack and Bore Operation



APPENDIX A

Figure 9: Lowering Section of Pipe into Trench



APPENDIX A

Figure 10: Above-Ground Pre-Fabrication of Valve Assembly



APPENDIX A

Figure 11: Hydrotest Equipment



Figure 12: Hydrotest Set Up with Sound Proofing to Minimize Noise Complaints (located behind Baker tank)



APPENDIX A

Figure 13 – Baker Tanks



Figure 14: L-2000 Tie-In Construction



APPENDIX A

Figure 15: Feature to be Removed from L-2000W Before Hydrotest



Figure 16: CNG for Temporary Bypass



APPENDIX A

Figure 17: Above-Ground Valve Equipment



Figure 18: Large Valve Station with Numerous Above-Ground Features



WP-G- 1 - 10
Appendix B - Glossary

APPENDIX B

GLOSSARY OF TERMS

The following list of acronyms, terms and high level definitions are intended to accompany the workpapers that support SoCalGas and SDG&E's 2016 PSEP Reasonableness Review application and specifically testimony Chapters III and V. These terms describe cost, gas operations, construction and land use terms that may not be commonly understood. They also provide the full name for less common acronyms that are referenced in these workpapers. This is not a comprehensive or detailed glossary of utility and construction terms. It is assumed that the reader is familiar with basic utility industry and regulatory terms, and as such, those terms and acronyms have been intentionally omitted from this list.

Acronym	Term	Definition
	Actuator	A device that causes a valve to move from the open to the closed position or vice versa.
	Alliance Contractor	SoCalGas and SDG&E solicited competitive bids on rates from qualified Electrical Contractors for four geographic regions, and selected contractors to be the "Alliance" contractors for electrical construction activities on PSEP valve projects.
AFUDC	Allowance for Funds Used During Construction	Net costs for borrowed funds used for construction purposes
ASV	Automatic Shut-off Valve	A valve that has electric or gas powered actuators to operate the valve automatically based on data sent to the actuator from pipeline sensors. The sensors send a signal to close the valve based on predetermined criteria, generally based on pipeline operating pressure or flow rate.
	Ball Valve	A valve that is opened and closed by pivoting a ball with a hole that fits into a cup-shaped opening to control gas flow.
	Bell Hole	An excavation that minimizes surface disturbance and provides sufficient room for examination or repair of buried facilities.
	Block Valve	A mechanical device (valve) installed in a pipeline that can be closed to block the flow of oil or gas through the line.
	Blowdown	A controlled activity to release of gas from an active pipe section in preparation to isolate sections for maintenance or construction activities.
	Blow-off Valve	A valve that is utilized to reduce pressure in the pipeline by venting by venting gas to atmosphere.
	Bollards	Short vertical post structures to control or direct road traffic.

APPENDIX B

	Bore Pit	An excavation that allows for the boring equipment to either send or receive pipe which has been bored through earth.
	Boring	The act or process of making or enlarging a hole.
	Branch Connection	A fitting which provides an outlet from a larger pipe to a smaller one (or one of the same size).
	Bridle	A bridle pipeline system is designed to allow alternative flow to isolate a section or entire pipeline from service. It can allow alternative feed options during isolation activities.
	Bypass	Delivery of gas through alternate piping that allows for a section of pipeline to be isolated from the system.
	Capital	Costs of new additions of plant, property and equipment that have a useful life of more than one year. New additions include any costs incurred to construct, install and/or prepare plant, property, and equipment for its intended use.
	Category 1	Includes those pipelines and pipeline segments that have documentation of hydrostatic pressure testing per NTSB Safety Recommendation P-10-2 (Urgent).
	Category 2	Includes those pipelines and pipeline segments that have documentation of pressure testing using a medium other than water.
	Category 3	Includes those pipelines and pipeline segments that have a documented highest historical operating pressure that is at least 1.25 times the current MAOP.
	Category 4	Includes pipelines that lack sufficient documentation of a post-construction strength test to 1.25xMAOP. All Category 4 pipeline segments were prioritized for further analysis and action per NTSB Safety Recommendation P-10-4.
	Check Valve	A valve that allows liquids or gases in a pipeline to flow in one direction but closes to prevent flow in the opposite direction. These types of valves are used extensively in the pipeline industry to prevent reverse-flow or back-flow in the event of a pipeline leak or abnormal operating occurrence.
	Class 1	An offshore area; or any class location unit that has 10 or fewer buildings intended for human occupancy.
	Class 2	Any class location unit that has more than 10 buildings but fewer than 46 buildings intended for human occupancy.

APPENDIX B

	Class 3	A Class Location unit that has 46 or more buildings intended for human occupancy or is an area where the pipeline lies within 100 yards (300 feet) of any of the following: building, a small well defined outside area, outdoor theater, or other place of public assembly) that is occupied by 20 or more persons on at least 5 days a week for 10 weeks in any 12-month period. (The days and weeks need not be consecutive.)
	Class 4	A Class 4 location is any class location unit where buildings with four or more stories above ground are prevalent.
	Class location or Class	A criterion for pipeline design set by the Code of Federal Regulations, Title 49, Part 192.
	Coal Tar	A water-resistant bituminous material that is used as a coating to protect the pipelines against underground corrosion.
	Coal Tar Wrap	A thermoplastic polymeric coating produced from the plasticization of coal tar pitch, coal and distillates, followed by the addition of inert filler.
CSED	Combination Service Entrance Device	Enclosure for electric watt-hour meter including main and branch circuit breaker.
	Competitive Bid	A procurement method in which the selection of the successful bidder is based on submitted bids from vendors or contractors for goods and services.
CMS	Construction Management System	Gas distribution planning system used by SoCalGas' Field Operations.
C/P	Control and Power only (ASV to RCV Conversion)	Adding power and communications to convert from ASV to RCV valve technology.
	Control Valve	A valve used to control conditions such as flow, pressure, and liquid level by fully or partially opening or closing in response to signals received from controllers that compare a "set-point" to a "process variable" whose value is provided by sensors that monitor changes in such conditions.
	Coupon	A sample piece of the material cut out of the pipeline.
	Criteria	Class 3 & 4 location and Class 1 & 2 High Consequence Area (HCA).
	Dewater	The removal of the test water from the pipeline.
DNGP	Digital Natural Gas Positioner	Equipment that provides continuous, offline, online diagnostics for online control valve monitoring, high-end component health and predictive valve maintenance.

APPENDIX B

	Direct Costs	Direct costs are those activities and services that support a specific project, such as salaries of staff employees (labor costs) and materials required for a specific project (non-labor costs).
	Disbonded	Any loss of bond between the protective coating and steel pipe as a result of coating adhesion failure, chemical attack, mechanical damage, hydrogen concentrations.
	Drain	A capped off section of gas line which is installed in such a way that any debris or moisture in the gas line will be caught in the trap where it can be cleaned out
	Drip Leg	An additional section of gas pipeline which is installed in such a way that any debris or moisture in the gas line will be caught in the trap where it can be cleaned out.
	Drip Pot	Drains installed on the bottom of pipelines to capture and remove liquid and solid debris pushed along the pipeline.
	Elbow	A fitting which is bent in such a way to produce 90 degree change in the direction of flow in the pipe.
	Encroachment	An "encroachment" is defined in Section 660 of the California Streets and Highways Code as "any tower, pole, pole line, pipe, pipeline, fence, billboard, stand or building, or any structure, object of any kind or character not particularly mentioned in the section, or special event, which is in, under, or over any portion of the State highway rights of way."
ECDA	External Corrosion Direct Assessment	A four-step process that includes pre-assessment, indirect inspection, direct examination, and post assessment to evaluate the threat of external corrosion to the integrity of a pipeline.
	Feature Study	A study that provides all the physical components of a pipeline and all the attributes associated with those components.
	Flow Meter	An instrument used for measuring flow rate of gas, such as an Ultrasonic Flow Meter.
	Flow Valve	A control valve that regulates the flow or pressure of the gas.
GTO	Gas Transmission Operations	Organization responsible for operation and maintenance of gas transmission pipeline system, which can include capital projects.
GMA	General Management and Administration	Means by which to track PSEP programmatic costs incurred in support of PSEP project execution. The PSEP GMA was created in order to create a process by which to track, monitor, and allocate PSEP support costs to the various PSEP projects

APPENDIX B

GPR	Ground Penetrating Radar	A geophysical method that uses radar pulses to image the subsurface. This nondestructive method uses electromagnetic radiation in the microwave band (UHF/VHF frequencies) of the radio spectrum, and detects the reflected signals from subsurface structures.
	Guy Wire	A tensioned cable designed to add stability to a free-standing structure.
HCA	High Consequence Area	A location that is specially defined in pipeline safety regulations as an area where pipeline releases could have greater consequences to health and safety or the environment. Regulations require a pipeline operator to take specific steps to ensure the integrity of a pipeline for which a release could affect an HCA and, thereby, the protection of the HCA.
HDD	Horizontal Directional Drilling	A trenchless method of installing underground pipe.
	Hot Line	Pipelines under pressure, loaded lines.
	Hot Tap	The method of making a connection to existing piping without the interruption of emptying that section of pipe. The pipe can continue to be in operation while maintenance or modifications are being done to it.
	Hot Tie-in	Activity that connects two pipelines together while the source pipeline still contains natural gas.
	H-pile	A type of shoring.
	Indirects	Costs including property tax, AFUDC and overheads.
ILI	In-line Inspection	A pipeline inspection technique that uses devices known in the industry as “smart pigs.” These devices run inside the pipe and provide indications of metal loss, deformation and other defects.
	Jack-and-Bore	Method of horizontal boring sewer construction. Construction crews drill a hole underground horizontally between two points without disturbing the surface between sending and receiving pits.
	K-rail	A term borrowed from the California Department of Transportation specification for temporary concrete traffic barriers.
	Lateral	A segment of a pipeline that branches off of the main or transmission line to transport the product to a termination point.
	Line Break	See “Automatic Shut-off Valve.”
	Line-seasoning	Also referred to as “pickling” the line, the pre-odorization of gas pipelines to maintain the odorant level of the pipeline.

APPENDIX B

	Loaded Costs	Direct costs and indirect costs
MLV	Mainline Valve	A valve positioned at a location along the pipeline system that can be closed down to isolate a line section in an emergency or for maintenance purposes.
MAOP	Maximum Allowable Operating Pressure	The maximum pressure at which a pipeline or segment of a pipeline may be operated under [49 CFR 192] and the provisions of ASME B31.8.
MRC	Measurement Regulation and Control	A department within SoCalGas and SDGE that manages meter and regulation activities such regulator station operations, larger customer meters, etc.
	Miter bend	A joint made by beveling each of two parts to be joined, usually at a 45° angle, to form a corner, usually a 90° angle.
A/AG	New Actuator Above Ground	A technology component added above ground to an existing valve that is responsible for controlling the valve.
A/VT	New Actuator in Vault	An actuator that has been installed below ground (housed inside a vault) and added to an existing valve.
NV/AG	New Valve and Actuator Above Ground	A valve and actuator installed above ground
NV/NP	New Valve and Actuator in Replaced Pipe	A new valve and actuator installed on an existing pipeline.
NV/VT	New Valve and Actuator in Vault	A technology component added below ground (housed inside a vault) to a new valve that is responsible for controlling.
	Nipple	A short stub of pipe, usually threaded steel, brass, chlorinated polyvinyl chloride (CPVC) or copper; occasionally just bare copper.
NDE	Nondestructive Examination or Nondestructive Testing (NDT)	An analysis technique used in science and industry to evaluate the properties of a material, component or system without causing damage. This testing is performed on pipelines during construction.
NOP	Notice of Operation	This is the date that used to signify that an asset is in operation.
O&M	Operations and Maintenance	Costs that support activity that is related to operation and maintenance activities on an asset.
	Overheads	The different loaders applied to direct costs
	Performance Partner	SoCalGas and SDG&E solicited competitive bids on rates from qualified pipeline construction contractors for four geographic regions, and selected contractors to be the Performance Partner for four geographic regions.

APPENDIX B

	(Pierced) Hump Bands	A method of repair and reinforcement of pipelines damaged due to internal and/or external corrosion, gouges, dents, cracks and defective welds. Piercing refers to the action that allows gas in the expanded chamber.
	Pig	A tool that is sent down a pipeline and propelled by the pressure of the product flow in the pipeline itself. Used to perform various maintenance operations.
	Piggable	A piggable pipeline is a pipeline that is designed to allow a standard inspection tool to negotiate it.
PIT	Pipeline Integrity	Department within SoCalGas and SDGE that manages/oversees certain aspects of pipeline integrity and compliance work.
	Plug valve	Is shaped like a cylinder or cone and can be rotated inside the valve body to control flow of fluids.
	Plume Study	An evaluation to determine minimum required horizontal separation distance between a temporary blowdown-stack and nearest potential ignition source during a blowdown operation.
	Pneumatic Actuator	Converts energy (typically in the form of compressed air) into mechanical motion.
	Potholing	An excavation used to locate known subsurface utilities. Potholing is most often used when a contractor needs to verify the depth, size or type of underground utility.
PCV	Pressure Control Valve	A control valve used to control pressure by fully or partially opening or closing in response to signals received from controllers that compare a "set-point" to a "process variable" whose value is provided by sensors that monitor changes in such conditions.
PRV	Pressure Relief Valve	A mechanical safety device that provides protection to a pressurized container, such as a pipeline, by reducing the internal pressure by releasing it outside the container.
	Pressure Transducers	A device that measures pressure in a liquid, fluid, or gas.
	Pressure Transmitter	A device that measures pressure in a liquid, fluid, or gas and communicates signal.
PLC	Programmable Logic Controller	A digital computer used for automation of typically industrial electromechanical processes, such as control of machinery on factory assembly lines, amusement rides, or light fixtures.
	Pup	A short length of pipe.
RFWN	Raised Face Weld Neck	A configuration for a flange.
	Reducer	The component in a pipeline that reduces the pipe size from a larger to a smaller bore (inner diameter).

APPENDIX B

	Regulator Station	Controls the gas pressure for major sections of the distribution system.
RCV	Remote Control Valve	A Remote Control Valve (RCV) is a valve equipped with electric or gas powered actuators to operate (open or close) the valve based on an order (signal) from a remote location, such as a gas control room.
RER	Request for Engineering Review	Formal process by which the engineering department reviews pipeline change requests and determines system impacts based on engineering analysis.
ROW	Right of Way	A strip of land on which pipelines, railroads, power lines, and other similar facilities are constructed. It secures the right to pass over property owned by others and ROW agreements only allow the right of ingress and egress for the operation and maintenance of the facility.
	Segment	A length of pipeline or part of the system that has unique characteristics. A section of pipe can be made up of multiple segments.
	Segment-able Ells	Elbow fittings which are capable of being divided into segments.
	Service Valve	A valve used to separate one piece of equipment from another in a natural gas system and typically refers to the separation between a customer and company's piping.
	Single Sourced	A contract for the purchase of goods (materials) or services that is entered into by the Company without competition, even though there other suppliers available to provide the same type of material or service.
	Slide rail	A type of shoring.
	Slot trenching	The process of digging narrow trenches for installing pipes, cables or other in-ground utilities.
SCORE /DBE	Smaller Contractor Opportunity Realization Efforts/Diverse Business Enterprise	A multi-team approach to expand the pool of smaller diverse businesses in our supplier base
	Sole Sourced	A contract for the purchase of goods (materials) or services that is entered into by the Company without competition because the supplier is the only source.
SMYS	Specified Minimum Yield Strength	The specified minimum yield strength for steel pipe manufactured in accordance with a listed specification.
	Stopple	A plug which can stop the flow of gas.

APPENDIX B

	Subpart J	Subpart J refers to CFR 49 Part 192, Subpart J – Test requirements, which is a section of the Code of Federal Regulations (CFR) that prescribes minimum leak-test and strength-test requirements for pipelines.
SCADA	Supervisory Control and Data Acquisition	A system for remote monitoring and control that operates with coded signals over communication channels (using typically one communication channel per remote station) SCADA Pack refers to an industrial computer system that monitors and controls a process.
SL	Supply Line	A distribution supply line can be either a transmission line or a distribution main and is operated at a pressure more than 60 psig, and: a) Supplies one or more distribution regulator stations, or supplies three or more customers.
	Syphon Drip	A capped off section of gas line which is installed in such a way that any moisture in the gas line will be caught in the trap where captured liquids can be removed.
	System Average Cost	The SoCalGas and SDG&E average cost per mile to pressure test a pipeline segment. Used to determine certain disallowances per D.14-06-007 and D.15-12-020.
	Tap Valve	A welded branch connection with valve made to a pipeline in the form of a single connection to supply or transfer gas between pipeline systems.
TPE	Target Price Estimate	The estimate for construction contractor costs that is negotiated between the Performance Partner and a third-party estimator and approved by SoCalGas/SDG&E.
	Tee	A pipe fitting which is T-shaped having two outlets, at 90° to the connection to the main line. It is used for connecting pipes of different diameters or for changing the direction of pipe runs.
TRE	Temporary Right of Entry	Temporary permission to enter and perform various activities on private property which include but is not limited to land and environmental surveys to support planning and design and contractor laydown yards and work space in support of construction.
	Test Head	A piece of equipment through which water is pumped to conduct a pressure test. A pipeline that will be pressure tested has a test head welded to the end of a pipeline segment .
T&E	Time and Expense	A contract for construction, product development or any other piece of work in which the employer agrees to pay the contractor based upon the time spent by the contractor's employees and subcontractors employees to perform the work, and for expenses realized as a result of the contracted project.

APPENDIX B

T&M	Time and Material	A contract for construction, product development or any other piece of work in which the employer agrees to pay the contractor based upon the time spent by the contractor's employees and subcontractors employees to perform the work, and for materials used in the construction (plus the contractor's mark-up).
	Time-and-material, not-to-exceed	A contract in which the contractor can bill the work being performed, but there is a cap that could be used as the maximum amount being charged by the contractor.
TIC	Total Installed Cost	Estimated forecast of a projects final direct costs.
	Two-sack Slurry	A slurry is a thin wet mud or cement or, in extended use, any fluid mixture of a pulverized solid with a liquid (usually water). The sack designation indicates the amount of aggregate/cement added to the sand.
	Valve	A device that controls the flow of natural gas.
	Vault	An underground room/space providing access to subterranean Public Utility equipment, such as valves for water or natural gas pipes, or switchgear for electrical or telecommunications.
	Wedding bands	A welded sleeve on a pipeline that can be used to repair gas transmission pipelines. It allows for full encirclement repair over damage/defects.
WOA	Work Order Authorization	Also referred to as a Phase 2 WOA. This is the fully loaded estimate for all project costs and is created during Stage 3 of the PSEP Seven Stage process.
	Wrinkle Bend	A pipe bend produced by a field machine or controlled process which may result in abrupt contour discontinuities on the inner radius.

WP-III-A1 - A429
Pipeline Pressure Test/Replacement Projects

WP-III-A1 – A429
PIPELINE PRESSURE TEST/REPLACEMENT PROJECTS

Project Line	WOA Date	Project Type	Line Type	Miles / Feet	Workpaper Page
1005	2/5/2014	Replacement	Transmission	0.0286 mi (150.9 ft.)	WP-III-A1 – A18
1011	4/28/2014	Replacement	Transmission	0.0767 mi (405 ft.)	WP-III-A19 – A31
1013	3/13/2014	Replacement	Transmission	0.0265 mi (140 ft.)	WP-III-A32 – A45
1014	5/15/2014	Replacement	Transmission	0.0029 mi (15.4 ft.)	WP-III-A46 – A58
1015 (North & South)	5/12/2014	Test	Transmission	0.4094 mi	WP-III-A59 – A76
2000 West Sec (1,2,3)	7/17/2014	Test	Transmission	14.571 mi	WP-III-A77 – A98
2001 West A Sec (15,16)	8/5/2014	Replacement	Transmission	0.0059 mi (31.02 ft.)	WP-III-A99 – A110
2001 West B Sec (10,11,14)	7/9/2014	Test	Transmission	2.9394 mi	WP-III-A111 – A132
		Replacement			
2003 Sec (1,3,4)	7/9/2014	Test	Transmission	0.2492 mi	WP-III-A133 – A152
		Replacement			
235 West Sawtooth Canyon	9/4/2014	Replacement	Transmission	0.3239 mi	WP-III-A153 – A163
33-120 Section 2	12/18/2013	Replacement	Distribution	0.2790 mi	WP-III-A164 – A178
35-20-N	1/2/2013	Replacement	Distribution	0.0131 mi (69 ft.)	WP-III-A179 – A190
36-37	9/3/2013	Replacement	Distribution	0.0119 mi (62.6 ft.)	WP-III-A191 – A200
36-9-09 North Section 2B	6/2/2014	Test	Distribution	2.1540 mi	WP-III-A201 – A215
36-9-09 North Section 6A	6/2/2014	Test	Distribution	0.916 mi	WP-III-A216 – A229
36-1032 Sec (1,2,3)	12/10/2013	Replacement	Distribution	0.6532 mi	WP-III-A230 – A256
38-539	6/25/2014	Replacement	Distribution	2.613 mi	WP-III-A257 – A274
406 Sec (1,2,2A,4,5)	5/19/2014	Test	Transmission	1.1 66 ₉₉ mi	WP-III-A275 – A300
		Replacement			
407 (North & South)	1/31/2014	Test	Transmission	2.998 mi	WP-III-A301 – A321
41-30-A	7/9/2014	Replacement	Distribution	0.0203 mi (107 ft.)	WP-III-A322 – A331
45-120 Section 1	12/10/2013	Replacement	Distribution	0.553 mi	WP-III-A332 – A344
45-120X01	9/3/2013	Replacement	Distribution	0.0108 mi (57 ft.)	WP-III-A345 – A3 65 ₇
49-14	2/27/2014	Replacement	Distribution	0.0316 mi (166.8 ft.)	WP-III-A3 65 ₈ – A38 0 ₁
49-22	8/27/2014	Abandonment	Distribution	4.046 mi	WP-III-A38 12 – A39 56
49-32	11/21/2013	Replacement	Distribution	0.0629 mi (332 ft.)	WP-III-A39 67 – A413
PDR Storage Phase 4 and 5	12/17/2014	Test	Storage	0.2686 mi	WP-III-A41 45 – A429

Pipeline Safety Enhancement Program Workpaper Supporting Chapter III
LINE 1005 REPLACEMENT PROJECT

Summary

Table 1: Summary of L-1005 Replacement Project

Project Name	L-1005 Replacement Project
WOA Number / WOA Date	91036 / February 5, 2014
City	Carpinteria
Original Pipe Diameter/New Diameter	██████████
Construction Start / Finish	September 8, 2014 / March 3, 2015
Loaded Capital Costs	\$ 6,476,402
Loaded O&M Costs	\$ 0
Total Loaded Project Costs	\$ 6,476,402
Disallowance	\$ 3,910 (Capital)

Background

L-1005 is a 38-mile transmission pipeline of mostly ██████████ and ██████████ diameter pipes that runs from the Goleta Storage Facility to the Ventura Compressor Station. During the planning process for the L-1005 Replacement Project, SoCalGas and SDG&E determined that it would coordinate the planning and execution of several PSEP projects in the vicinity of this project for the purposes of minimizing customer impacts and managing costs. These PSEP projects include:

- The L-1005 Replacement Project, which consists of the replacement of two pipeline segments totaling 151 feet; the relocation of MLV 1005-18.39; and partial abandonment of crossover lines L-1215 and L-1216, both Category 4. These crossover lines connect L-1005 and L-1004 and run under Highway 101. (See figure 7).
 - Relocation of MLV 1005-18.39 was necessary to move the valve away from Highway 101 to a safer, more constructible and serviceable location.

Pipeline Safety Enhancement Program Workpaper Supporting Chapter III

LINE 1005 REPLACEMENT PROJECT

- Abandonment of L-1215 and L-1216 was considered the best option because these lines run under Highway 101 and presented both access and costly constructability challenges.
- The L-1004 Hydrotest Project, which consists of a hydrotest, completion of the abandonment of L-1215 and L-1216, and the installation of new cross-tie 8119.
- The Santa Barbara L-1005 Valve Project, which involves automation of the relocated MLV 1005-18.39.

Construction on L-1004 and L-1005 could not be executed concurrent due to capacity constraints (one line needs to remain operational while the other is serviced). To minimize blowdowns and operational impacts, the construction had to be performed sequentially, with the L-1005 Replacement Project being the first in the series. This workpaper describes the activity and costs associated with the L-1005 Replacement Project. The L-1004 Hydrotest Project and the Santa Barbara L-1005 Valve Project will be submitted in future reasonableness review applications.

Description

Through the L-1005 Replacement Project, SoCalGas and SDG&E enhanced its high-pressure transmission pipeline system by successfully replacing 151 feet of pipe. As part of the L-1005 Replacement Project, SoCalGas and SDG&E also replaced a mainline valve and partially abandoned two crossover lines – L-1215 and L-1216. The L-1005 Replacement Project and associated work is shown in Figures 1 through 6 and Table 2 that describe the project scope as submitted in the 2011 PSEP filing and the final mileage.

Examples of cost avoidance actions included:

- SoCalGas and SDG&E coordinated projects within the same vicinity of the L-1005 work to minimize construction costs and customer impacts.
- SoCalGas and SDG&E relocated an MLV for future automation to increase safety and decrease future maintenance costs.

Pipeline Safety Enhancement Program Workpaper Supporting Chapter III
LINE 1005 REPLACEMENT PROJECT

- Through scope validation efforts, SoCalGas and SDG&E reduced the scope of L-1005 by over 3 miles.
- SoCalGas and SDG&E installed new pipe in lieu of pressure testing two 1950's vintage Category 4 Criteria pipelines under Highway 101.

Construction began in September 2014 and was completed in March 2015. The L-1005 Replacement Project incurred a total loaded project cost of \$6,476,402.

Table 2: L-1005 Replacement Project 2011 PSEP Filing and Final Mileage*

Line 1005	Total Mileage	Criteria Mileage	Accelerated Mileage**	Incidental Mileage
2011 PSEP Filing	3.500 mi.	1.307 mi.	2.193 mi.	0
Final Project Mileage				
Site 1	90 ft.	25 ft.	52 ft.	13 ft.
Site 2	61 ft.	0	0	61 ft.
Total	151 ft.	25 ft.	52 ft.	74 ft.

**Values may not add to total due to rounding.*

***Accelerated mileage includes Phase 1B and Phase 2 pipe. Phase 2 includes pipelines without sufficient record of a pressure test in less populated areas (Phase 2A) or pipelines with record of a pressure test, but without record of a pressure test to modern – Subpart J – standards (Phase 2B). Included in this project was 52 feet of pipe accelerated from SoCalGas and SDG&E's PSEP Phase 2B. This Phase 2B footage was included to realize efficiencies and to enhance project constructability.*

Pipeline Safety Enhancement Program Workpaper Supporting Chapter III
LINE 1005 REPLACEMENT PROJECT

Figure 1: Overview Map of L-1005 Replacement Project Site 1 and Site 2 (Revised)

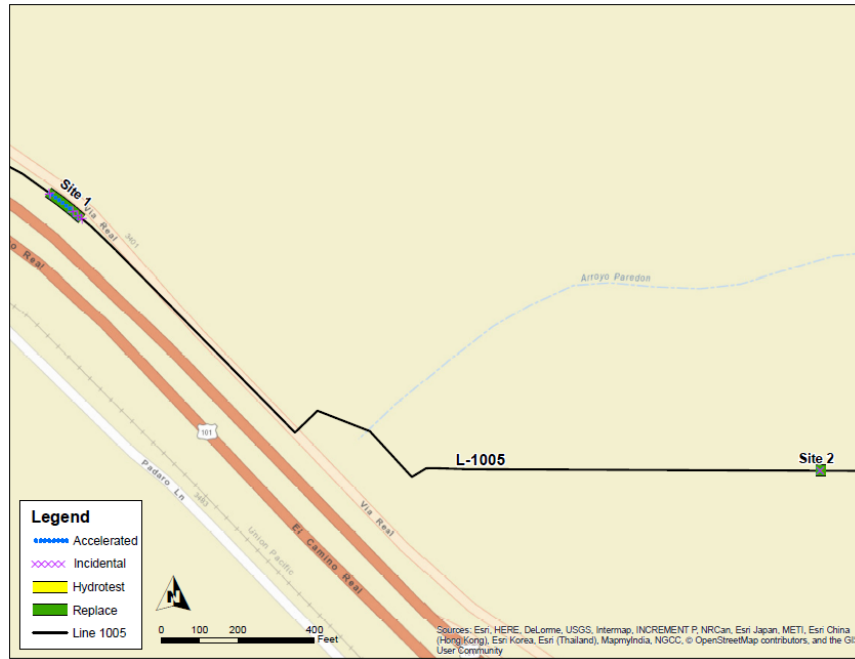


Figure 2: Satellite Image of L-1005 Replacement Project Site 1 and Site 2



Pipeline Safety Enhancement Program Workpaper Supporting Chapter III
LINE 1005 REPLACEMENT PROJECT

Figure 3: Map of L-1005 Replacement Project Site 1

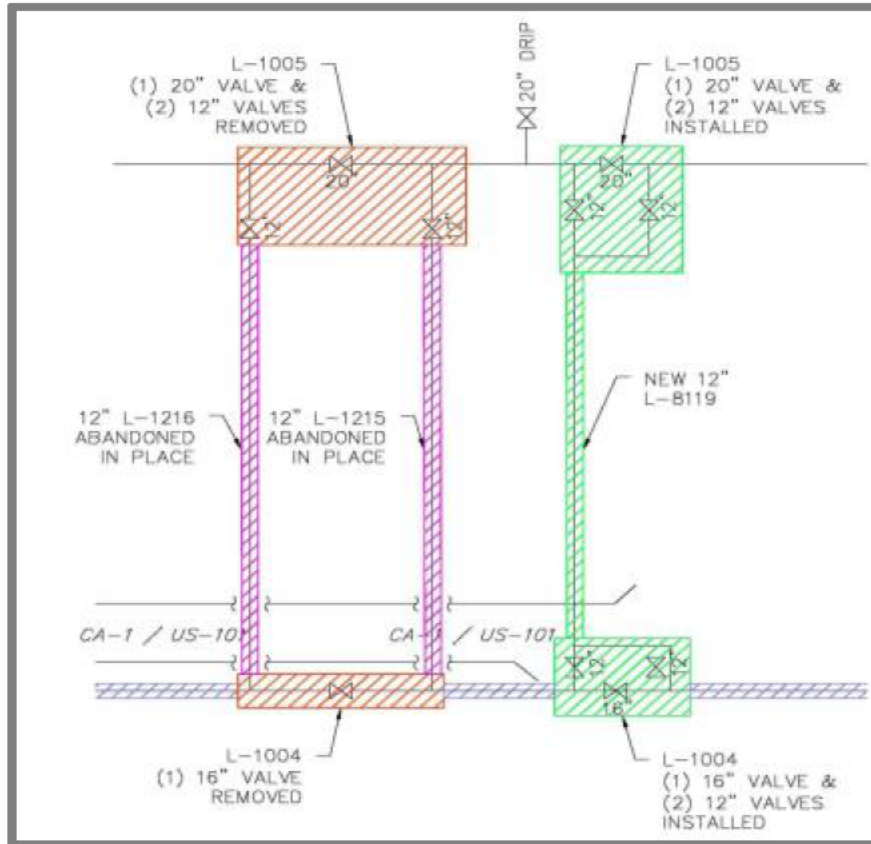


Figure 4: Satellite Image of L-1005 Replacement Project Site 1



Pipeline Safety Enhancement Program Workpaper Supporting Chapter III
LINE 1005 REPLACEMENT PROJECT

Figure 7: L-1005 to L-1004 Crossover Diagram Not to Scale



Pipeline Safety Enhancement Program Workpaper Supporting Chapter III
LINE 1005 REPLACEMENT PROJECT

Stage 1 – Project Initiation

In workpapers supporting the 2011 PSEP filing,¹ SoCalGas and SDG&E identified L-1005 as a Phase 1A replacement project. It comprised approximately 1.307 Category 4 Criteria miles and 2.193 accelerated miles in the Class 3 area of the City of Carpinteria.

Upon completion of scope validation for L-1005, the existing hydrotest records supported a scope reduction of Category 4 Criteria mileage from 1.307 miles to 4,011 feet. Accelerated mileage decreased from 2.193 miles to 5 feet.

¹ See December 2, 2011 Amended Pipeline Safety Enhancement Plan (PSEP) of SoCalGas and SDG&E.

Pipeline Safety Enhancement Program Workpaper Supporting Chapter III
LINE 1005 REPLACEMENT PROJECT

Stage 2 – Analysis and Findings

During Stage 2, data analysis was performed and the findings were used to define project scope and to plan tasks for later stages of the L-1005 Project.

For the 4,011 feet of Criteria pipe on L-1005, after completing a site visit and conducting further investigation, SoCalGas and SDG&E confirmed that 3,985 feet of Category 4 pipe was non-HCA. As a result, the non-HCA footage was deferred to Phase 2. The remaining 25 feet of pipe includes MLV 1005-18.39, pipe adjacent to the valve, and two 12-inch branch connections that provide crossovers (L-1215 and L-1216) to Line 1004. MLV 1005-18.39 is one of the valves identified for automation as part of the PSEP Valve Enhancement Plan.²

Engineering Factors

A PSEP Decision Tree analysis of L-1005 confirmed that the project design should commence as a replacement project because L-1005 scope was less than 1000 feet. The PSEP Decision Tree directs that scope less than 1000 feet should be replaced because under most circumstances it is the cost effective option. In this instance, there were no conditions that justified overriding this guidance.

² MLV 1005-18.39 automation work was done by the PSEP valve team under the project name Santa Barbara L-1005 Valve Project, commissioned on January 12, 2016. This project's workpaper will be included in a future reasonableness review application.

Pipeline Safety Enhancement Program Workpaper Supporting Chapter III
LINE 1005 REPLACEMENT PROJECT

Stage 3 – Initial Planning and Design

During Stage 3, SoCalGas and SDG&E developed a Phase 2 WOA estimate and began field surveys to complete preliminary design drawings and further refine the scope.

In addition to the schedule and estimate, other key activities include identifying all permits, TREs, and easements, defining long lead materials and pricing, understanding customer impacts and interruptions, and preparing any necessary environmental submittals.

Planning and Design Activity

The initial design for L-1005 was planned in coordination with plans for the L-1004³ hydrotest project due to operational and system considerations.

The following was included in the design:

- L-1005 was divided into two sites for constructability reasons (see Figure 7):
 - Site 1 would consist of removing the MLV and replacing it with straight pipe, and removing the crossover valves.
 - Site 2 would consist of installing the new MLV and a new bridle assembly in preparation for the new crossover line 8119 (see Figure 8).
- The proximity of overhead electric lines required a Plume Study⁴ to determine whether a blow down line could be located at the new MLV location.

³ Line 1004 hydrotest construction began on May 11, 2015 and the line was returned to service on August 13, 2015. This project will be included in a future reasonableness review application.

⁴ A Plume Study was conducted to calculate the release rate of gas from the vent, and the subsequent dispersion of gas, to assess whether the gas concentrations at the nearby power lines are likely to exceed the flammable concentration.

Pipeline Safety Enhancement Program Workpaper Supporting Chapter III
LINE 1005 REPLACEMENT PROJECT

Additional Considerations

- A more optimal alignment could be achieved by rerouting L-1215 and L-1216 and moving the new MLV.
- One high-pressure customer could potentially require CNG support during construction.

Cost Avoidance

- SoCalGas and SDG&E coordinated projects within this same vicinity to address L-1004, crossover lines L-1215 and L-1216, and relocate a valve to minimize construction costs, system blowdowns, and customer impacts.
- SoCalGas and SDG&E relocated the MLV and actuator to an area away from the highway to allow ease and safe access for future O&M activities and other PSEP valve enhancement efforts. By moving the MLV to a more ideal location, the MLV could be more efficiently automated by the PSEP valve team⁵ and would require less field personnel visits to maintain and operate, thereby reducing costs.
- SoCalGas and SDG&E designed the project to minimize costs by abandoning two Category 4 criteria pipelines. Instead of pressure testing or replacing two crossover pipelines under Highway 101, it was determined that it would be more cost effective to abandon two pipelines and build a new, single shorter crossover line.
- The new location of the line also enhanced safety and made for more efficient future operations by routing the line in a road under than freeway, rather than leave the two crossover lines under the freeway.

⁵ Costs associated with this valve enhancement will be presented in a future reasonableness review application.

Pipeline Safety Enhancement Program Workpaper Supporting Chapter III
LINE 1005 REPLACEMENT PROJECT

Revised Engineering Design

As a result of the Plume Study, the revised engineering design plan for L-1005 called for the elimination of the blow-off stack from the initial design.

Estimate of Costs

The estimate of the total loaded cost to complete the scope of work for L-1005 was \$3,629,956 as shown in Table 3, and was based on preliminary designs. The Phase 2 WOA estimate was prepared on January 30, 2014 using the Stage 3 SCG Pipeline Estimate Template Rev 0 estimating tool.

Table 3: L-1005 Replacement Project Phase 2 WOA Estimate

Cost Category	Phase 2 WOA
Company Labor Costs	\$ 551,696
Contract Costs	\$1,391,022
Material Costs	\$ 613,454
Other Direct Costs	\$ 158,926
Total Direct Costs	\$2,715,098
Total Indirect Costs	\$ 914,858
Total Loaded Costs	\$3,629,956

Pipeline Safety Enhancement Program Workpaper Supporting Chapter III
LINE 1005 REPLACEMENT PROJECT

Stage 4 – Detailed Engineering Design and Procurement

During Stage 4, detailed design and material procurement was completed in order to provide a construction ready packet to the construction contractor to execute the planned project scope.

The following actions were performed to prepare for project construction:

- Secured a laydown yard that was shared by both projects.
- Acquired TRE ahead of mobilization date.

Detailed Planning and Design

There were no scope changes from Stage 3 to Stage 4.

Construction Contractor Selection

Construction of the L-1005 Replacement Project utilized the PSEP Performance Partner Program and the construction contract was awarded to the Performance Partner selected for this geographic area.

The Performance Partner/Construction Contractor TPE was \$ [REDACTED], which is \$ [REDACTED] more than the Stage 3 construction contractor direct estimate of \$ [REDACTED] that was used to develop the Phase 2 WOA.

Pipeline Safety Enhancement Program Workpaper Supporting Chapter III
LINE 1005 REPLACEMENT PROJECT

Stage 5 – Construction

Schedule

Construction Start Date: 09/08/2014

NOP Date: 02/04/2015

Construction Finish Date: 03/03/2015

Construction lasted 25 weeks from initial mobilization to final demobilization instead of the planned 10 weeks. The hydrotests were performed on January 23, 2015 for Site 1 and on November 14, 2014 for Site 2. Both sites passed the hydrotest and both segments were tied-in and returned to service on February 4, 2015. The L-1005 new valve installation and supports is shown in Figure 8.

Field Conditions

Conditions were encountered in the field that were not anticipated during design and planning that had to be addressed or mitigated. Listed below is a summary of the key field changes broken down by type of change for this project.

Materials:

- Materials that were promised to be delivered prior to construction were delayed by 2.5 months, which delayed construction. This delay resulted in the first demobilization and remobilization.

Permit Conditions:

- SoCalGas worked actively with Santa Barbara County to obtain permits in a timely fashion. However, at Site 1 a one month delay was caused by difficulties securing an encroachment permit that was held up due to a last minute request from the

Pipeline Safety Enhancement Program Workpaper Supporting Chapter III
LINE 1005 REPLACEMENT PROJECT

County to provide proof of the Coastal Commission’s exemption. This delay resulted in a second demobilization and remobilization of 4.5 weeks.

Substructures:

- Due to the potential presence of unknown underground lines, the contractor was instructed to hand dig prior to mechanical digging.

Utility Coordination:

- The local electric utility had located a transformer near SoCalGas’ easement, which needed to be relocated to allow for the SoCalGas’ work to proceed. SCE had to secure a separate easement for the transformer, which caused delays.

Temporary Service:

- The provision of CNG to maintain customer service required a temporary lot for the CNG trucks and additional work to connect the customer to the CNG.

Figure 8: L-1005 Site 2 – Installation of New Valve and Supports



Pipeline Safety Enhancement Program Workpaper Supporting Chapter III
LINE 1005 REPLACEMENT PROJECT

Stages 6 and 7 – Commissioning and Closeout

Commissioning activities included site restoration, final inspections, and placement of the pipeline back into service, transportation and disposal of the hydrotested water or hazardous material and demobilization from the site. Close out activities included development of final drawings, the reconciliation package and updates to company systems to reflect the changes made to the system. Temporary fencing and K-rails were left on Site 2 to protect the newly installed valves but were later removed when the permanent fencing was installed.

Cost Variance

Table 4: L-1005 Replacement Project Phase 2 WOA Estimate and Actual Costs

COST SUMMARY				
	PHASE 2 WOA	CAPITAL (actuals)	DELTA over/(under)	
COMPANY LABOR	\$ 551,696	\$ 365,956	\$ (185,740)	
CONTRACT COSTS	\$ 1,391,022	\$ 3,305,596	\$ 1,914,574	
MATERIALS	\$ 613,454	\$ 151,233	\$ (462,221)	
OTHER DIRECTS	\$ 158,926	\$ 2,007,196	\$ 1,848,270	
INDIRECTS	\$ 914,858	\$ 646,421	\$ (268,437)	
TOTAL LOADED	\$ 3,629,956	\$ 6,476,402	\$ 2,846,446	

Table 4 compares the Phase 2 WOA estimate and the March 2016 total loaded actual costs. The total loaded actual costs exceeded the Stage 3 estimate by \$2,846,446.

The difference between the WOA and the total loaded actual costs is attributable to scope changes that occurred after the Phase 2 WOA estimate (including: unknown subsurface facilities and conditions, additional permitting requirements, delays and increased construction duration, two mobilizations and demobilizations, and additional costs to provide temporary CNG support); and an early cost estimating tool and process that was based on preliminary project designs (resulting in underestimating of the construction contractor costs and project support costs). These increased costs were reasonably incurred to complete this replacement work, but were not accounted for in the Stage 3 estimate.

Pipeline Safety Enhancement Program Workpaper Supporting Chapter III
LINE 1005 REPLACEMENT PROJECT

Disallowances

For this replacement project, SoCalGas and SDG&E have identified pipe as being installed post 1970 and lacking records that provide the minimum information to demonstrate compliance with industry standards or regulatory strength testing and recordkeeping requirements then applicable. Of the pipeline that was replaced, 12 feet of post-1970 is disallowed. Therefore a \$3,910 reduction was made to ratebase calculated by determining the replacement mileage and multiplying the amount by \$1.7 million per mile, which is SoCalGas' and SDG&E's system average cost of pressure testing.

Pipeline Safety Enhancement Program Workpaper Supporting Chapter III
LINE 1005 REPLACEMENT PROJECT

Conclusion

SoCalGas and SDG&E enhanced the safety of their natural gas system by prudently executing the L-1005 Replacement Project. Through this replacement project, SoCalGas and SDG&E successfully replaced 151 feet of non-contiguous pipe of varying diameter in the City of Carpinteria. The project incurred a total loaded project cost of \$6,476,402.

SoCalGas and SDG&E executed this project prudently: coordinating nearby pipeline and valve work to realize efficiencies (minimizing construction costs, system blowdowns, and customer impacts); designing the project to improve safety access and reduce costs (relocating a MLV to a more accessible location and replacing two crossover pipelines underneath the freeway with a new bridle); maintaining service to customers; and responding to numerous unanticipated field changes including material and permit delays and unknown subsurface facilities.

SoCalGas and SDG&E's total loaded project cost of \$6,476,402 is reasonable and should be approved (minus acknowledged disallowances). SoCalGas and SDG&E engaged in prudent cost avoidance efforts (reducing project scope through validation efforts, coordinating nearby PSEP work, and designing the project to realize efficiencies); engaged in reasonable efforts to promote competitive and market-based rates for contractor services and materials (see Chapter II (Phillips) (approximately 98% of PSEP agreements with contractors and suppliers were either competitively bid or through agreements entered into using market-based rates based on a recent competitive sourcing event)); and used a reasonable amount of company and contractor resources given the scope of work and changes and delays caused by material delays and permitting requirements.

End of L-1005 Replacement Project Workpaper

Pipeline Safety Enhancement Plan Workpaper Supporting Chapter III
LINE 1011 REPLACEMENT PROJECT

Summary

Table 1: Summary of L-1011 Replacement Project

Project Name	L-1011 Replacement Project
WOA Number / Date	91052 / April 28, 2014
City	Ventura
Original Pipe Diameter/New Diameter	██████████
Construction Start / Finish	July 21, 2014 / September 6, 2014
Loaded Capital Costs	\$2,656,749
Loaded O&M Costs	\$ 0
Total Loaded Project Costs	\$2,656,749
Disallowance	\$ 0

Description

Through the L-1011 Project, SoCalGas and SDG&E enhanced its high-pressure transmission pipeline system by successfully replacing 405 feet of primarily ██████████ diameter pipe, as shown in Figures 1, 2, and 3 and Table 2 that describes the project scope as submitted in the 2011 PSEP filing and the final construction mileage.

Example of cost avoidance actions included:

- Through scope validation efforts, SoCalGas and SDG&E reduced scope mileage by approximately 1.7 miles.

Construction began in July 2014 and was completed in September 2014. The L-1011 Replacement Project incurred a total loaded project cost of \$2,656,749.

Table 2: L-1011 Replacement Project 2011 PSEP Filing and Final Mileage*

Line 1011	Total Mileage	Criteria Mileage	Accelerated Mileage**	Incidental Mileage
2011 PSEP Filing	5.135 mi.	1.832 mi.	3.303 mi.	0
Final Project Mileage	405 ft.	337 ft.	68 ft.	0

*Values may not add to total due to rounding.

Pipeline Safety Enhancement Plan Workpaper Supporting Chapter III
LINE 1011 REPLACEMENT PROJECT

***Accelerated mileage includes Phase 1B and Phase 2 pipe. Phase 2 includes pipelines without sufficient record of a pressure test in less populated areas (Phase 2A) or pipelines with record of a pressure test, but without record of a pressure test to modern – Subpart J – standards (Phase 2B). . Included in this project was 51 feet of pipe accelerated from Phase 2A and 17 feet of pipe accelerated from Phase 2B. The accelerated mileage was included to realize efficiencies and to enhance project constructability.*

Pipeline Safety Enhancement Plan Workpaper Supporting Chapter III
LINE 1011 REPLACEMENT PROJECT

Figure 1: Overview Map of L-1011 Replacement Project



Figure 2: Satellite Image of L-1011 Replacement Project



Pipeline Safety Enhancement Plan Workpaper Supporting Chapter III
LINE 1011 REPLACEMENT PROJECT

Figure 3: Topographic Image of L-1011 Replacement Project



Pipeline Safety Enhancement Plan Workpaper Supporting Chapter III
LINE 1011 REPLACEMENT PROJECT

Stage 1 – Project Initiation

In workpapers supporting the 2011 PSEP filing,¹ SoCalGas and SDG&E identified L-1011 as a Phase 1A replacement project. L-1011 is a 5 mile long transmission pipeline of predominantly [REDACTED] diameter pipe in the Ventura District.

During Stage 1, SoCalGas and SDG&E completed scope validation analysis of the L-1011 Project and verified that:

- L-1011 was installed between 1947 and 1955.
- L-1011 was primarily classified as Class 3 in the residential areas in and around the Ventura Compressor Station and the Mills Road Station on either side of Hall Mountain and Class 1 in the rural Hall Mountain area.

Upon completion of this scope validation analysis, SoCalGas and SDG&E determined that the existing hydrotest records support the reduction of Category 4 Criteria mileage from 1.832 mi to 0.531 mi and accelerated mileage from 3.303 mi to 0 mi.

¹ See December 2, 2011 Amended Pipeline Safety Enhancement Plan (PSEP) of SoCalGas and SDG&E.

Pipeline Safety Enhancement Plan Workpaper Supporting Chapter III
LINE 1011 REPLACEMENT PROJECT

Stage 2 – Analysis and Findings

During Stage 2, data analysis was performed and the findings were used to define project scope and to plan tasks for later stages of the L-1011 Project.

Engineering Factors

Two unique sections, approximately 3 miles apart, were identified as Category 4 Criteria mileage that was to be addressed as part of PSEP Phase 1A. Because these sections are three miles apart, SoCalGas and SDG&E developed a plan to separately address the two sections in order to reduce overall costs for customers:

Section 1

- Based on the PSEP Decision Tree, SoCalGas and SDG&E confirmed that the Section 1 (266 feet of [REDACTED] diameter pipeline) project design should commence as a replacement project because the section's scope was less than 1,000 feet. The PSEP Decision Tree directs that scope less than 1,000 feet should be replaced because, under most circumstances, replacements will be the cost effective option. In this instance there were no conditions that justified overriding this guidance.

Section 2

- SoCalGas and SDG&E determined that Section 2 (3,840 foot section of [REDACTED] diameter pipeline) should be hydrotested to mitigate some of the difficulties of replacement construction on a steep hillside. Additionally, 1,300 ft. of pipe along Section 2 was added to the hydrotest to avoid an environmentally-sensitive area by having the staging location outside of the environmentally-sensitive areas of Hall Canyon.

Pipeline Safety Enhancement Plan Workpaper Supporting Chapter III
LINE 1011 REPLACEMENT PROJECT

Stage 3 – Initial Planning and Design

During Stage 3, SoCalGas and SDG&E developed a Phase 2 WOA estimate, and began field surveys to complete preliminary design drawings and further refine scope.

In addition to the schedule and estimate, other key activities include identifying all permits, TRES, and easements, defining long lead materials and pricing, understanding customer impacts and interruptions, and preparing any necessary environmental submittals.

Planning and Design Activity

SoCalGas and SDG&E revised Section 1 and removed Section 2 from the scope of the L-1011 Project. Section 2 was descoped from the L-1011 project because SoCalGas and SDG&E re-evaluated records and determined that sections previously identified as Category 4 Criteria were Category 1. This further reduced the Category 4 length from 0.531 miles to 337 feet.

Additional Considerations

As a result of a location class review, SoCalGas and SDG&E reclassified an approximately 70-foot section of pipe from Class 1 to Class 3 which would make the 70 feet Criteria mileage a part of PSEP Phase 1A. As such, Section 1 was revised to add approximately 70 feet of pipe to reflect the updated information.

Estimate of Costs

The Phase 2 WOA estimate for L-1011 Section 1 was \$2,073,271 and was based on preliminary design. This estimate was prepared on April 24, 2014 using the Stage 3 SCG Pipeline Estimate Template Rev 0. Notable adjustments made to the estimating tool's default values to reflect project specific issues included:

- Slope construction – Costs were increased to account for the construction challenges expected on the difficult hillside terrain.

Pipeline Safety Enhancement Plan Workpaper Supporting Chapter III
LINE 1011 REPLACEMENT PROJECT

- Cost to remove pipe – Costs were increased because the existing SoCalGas easement was not wide enough to abandon the pipe in place.

Table 3: L-1011 Phase 2 WOA Estimate

Cost Category	Phase 2 WOA
Company Labor Costs	\$ 269,898
Contract Costs	\$ 1,085,319
Material Costs	\$ 120,524
Other Direct Costs	\$ 121,683
Total Direct Costs	\$ 1,597,424
Total Indirect Costs	\$ 475,847
Total Loaded Costs	\$ 2,073,271

Pipeline Safety Enhancement Plan Workpaper Supporting Chapter III
LINE 1011 REPLACEMENT PROJECT

Stage 4 – Detailed Engineering Design and Procurement

During Stage 4, detailed design and material procurement was completed in order to provide a construction ready packet to the construction contractor to execute the planned project scope.

Detailed Planning and Design

There were no scope changes from Stage 3 to Stage 4.

Construction Contractor Selection

Construction of the L-1011 Project utilized the PSEP Performance Partnership Program and the construction contract was awarded to the Performance Partner selected for this geographic area.

The Performance Partner/Construction Contractor TPE was \$ [REDACTED], which is \$ [REDACTED] more than the Stage 3 construction contractor direct estimate of \$ [REDACTED] that was used to develop the Phase 2 WOA estimate.

Pipeline Safety Enhancement Plan Workpaper Supporting Chapter III
LINE 1011 REPLACEMENT PROJECT

Stage 5 – Construction

Schedule

Construction Start Date: 07/21/2014

NOP Date: 08/28/2014

Construction Finish Date: 09/06/2014

The construction of the L-1011 Replacement Project required an additional week of construction beyond the scheduled 5.5 weeks due to the discovery of disbonded coal tar wrap containing asbestos which was not anticipated prior to construction and required mitigation.

SoCalGas and SDG&E restored the laydown yard and surrounding area prior to demobilizing on September 6, 2014.

Field Conditions

Conditions were encountered in the field that were not anticipated during design and planning that had to be addressed or mitigated. Listed below is a summary of the key field changes broken down by type of change for this project:

Constructability Issues:

- Once the pipe was exposed, the planned tie-in locations were extended past a girth weld and for a more suitable tie-in location.

Environmental:

- The excavation operation was suspended due to the discovery of disbonded asbestos wrap on the existing pipeline, as is normal practice. The SoCalGas asbestos abatement crew cleaned up and safely removed the asbestos.

Pipeline Safety Enhancement Plan Workpaper Supporting Chapter III
LINE 1011 REPLACEMENT PROJECT

Stages 6 and 7 – Commissioning and Closeout

Commissioning activities included site restoration, final inspections, and placement of the pipeline back into service, transportation and disposal of the hydrotested water or hazardous material and demobilization from the site. Close out activities included development of final drawings, the reconciliation package and updates to company systems to reflect the changes made to the system.

Cost Variance

Table 4: L-1011 Phase 2 WOA Estimate and Actual Costs

COST SUMMARY				
	PHASE 2 WOA	CAPITAL (actuals)	DELTA over/(under)	
COMPANY LABOR	\$ 269,898	\$ 189,674	\$	(80,224)
CONTRACT COSTS	\$ 1,085,319	\$ 1,236,693	\$	151,374
MATERIALS	\$ 120,524	\$ 47,681	\$	(72,843)
OTHER DIRECTS	\$ 121,683	\$ 944,929	\$	823,246
INDIRECTS	\$ 475,847	\$ 237,772	\$	(238,075)
TOTAL LOADED	\$ 2,073,271	\$ 2,656,749	\$	583,478

Table 4 compares the Phase 2 WOA estimate and the March 2016 loaded actual costs. The Phase 2 WOA estimate was calculated using the Stage 3 SoCalGas Pipeline Estimate Template Rev. 0. The loaded actual costs exceeded the estimate by \$583,478.

The above variance is attributable to scope changes and unanticipated conditions that occurred after the Phase 2 WOA estimate (including: schedule delays and additional work caused by disbonded coal tar wrap and scope increase of 17 feet of pipe); and an early cost estimating tool and process that was based on preliminary project designs (resulting in underestimating of construction contractor costs, inspection and engineering costs, and support costs). These increased costs were reasonably incurred to complete the replacement, but were not accounted for in the Stage 3 estimate.

Pipeline Safety Enhancement Plan Workpaper Supporting Chapter III
LINE 1011 REPLACEMENT PROJECT

Disallowances

There was no disallowance for line L-1011 Replacement as there were no post-1955 segments included in the project without records that provide the minimum information to demonstrate compliance with industry standards or regulatory strength testing and recordkeeping requirements then applicable.

Pipeline Safety Enhancement Plan Workpaper Supporting Chapter III
LINE 1011 REPLACEMENT PROJECT

Conclusion

SoCalGas and SDG&E enhanced the safety of their natural gas system by prudently executing the L-1011 Replacement Project. Through this replacement project, SoCalGas and SDG&E successfully replaced 405 feet of pipe of varying diameter in the city of Ventura. The project incurred a total loaded project cost of \$2,656,749.

SoCalGas and SDG&E executed this project prudently: engaging in scope validation efforts that reduced project mileage and responding to numerous unanticipated field conditions including disbonded coal tar wrap and increased scope of work to address all Category 4 pipe.

SoCalGas and SDG&E's total loaded project cost of \$2,656,749 is reasonable and should be approved. SoCalGas and SDG&E engaged in prudent cost avoidance efforts (reducing project scope by over 1.7 miles); engaged in reasonable efforts to promote competitive and market-based rates for contractor services and materials (see Chapter II (Phillips) (approximately 98% of PSEP agreements with contractors and suppliers were either competitively bid or through agreements entered into using market-based rates based on a recent competitive sourcing event)); and used a reasonable amount of company and contractor resources given the scope of work (construction on a hillside and removal of abandoned pipe instead of abandoning in place) and Stage 5 work scope changes and project delays.

End of L-1011 Replacement Project Workpaper

Pipeline Safety Enhancement Plan Workpaper Supporting Chapter III
LINE 1013 REPLACEMENT PROJECT

Summary

Table 1: L-1013 Replacement Project Summary

Project Name	L-1013 Replacement Project
WOA Number / Date	91048 / March 13, 2014
City	Brea
Original Pipe Diameter/New Diameter	██████████
Construction Start / Finish	July 14, 2014 / October 29, 2014
Loaded Capital Costs	\$ 2,737,981
Loaded O&M Costs	\$ 0
Total Loaded Project Costs	\$ 2,737,981
Disallowance	\$ 30,770 (Capital)

Description

Through the L-1013 Replacement Project, SoCalGas and SDG&E enhanced its high-pressure transmission pipeline system by successfully replacing 140 feet of pipe and installation of a new mainline valve capable of automation,¹ as shown in Figures 1 and 2 and Table 2 that describes the project scope as submitted in the 2011 PSEP filing and the final construction mileage.

Examples of cost avoidance actions included:

- Coordination with valve enhancement project eliminated the cost of an additional blow down.
- Coordination with customer to avoid cost of alternate gas supply.
- Through scope validation efforts, SoCalGas and SDG&E reduced mileage by over 3 miles.

¹ See the Workpaper *Brea Station – 1013 Valve Project* for the costs and description of activity related to the automation of valve 1013-0.00.

Pipeline Safety Enhancement Plan Workpaper Supporting Chapter III
LINE 1013 REPLACEMENT PROJECT

- Coordination of valve mechanical work and pipeline replacement to realize efficiencies.

Construction began in July 2014 and was completed in October 2014. The L-1013 Replacement Project incurred a total loaded project cost of \$2,737,981

Table 2: L-1013 Replacement Project 2011 PSEP Filing and Final Mileage*

Line 1013	Total Mileage	Criteria Mileage	Accelerated Mileage	Incidental Mileage
2011 PSEP Filing	3.500 mi.	3.456 mi.	0.044 mi.	0
Total	140 ft.	129 ft.	0	11 ft.

** Values may not add to total due to rounding.*

Pipeline Safety Enhancement Plan Workpaper Supporting Chapter III
LINE 1013 REPLACEMENT PROJECT

Figure 1: Overview Map of Line 1013 Replacement Project



Figure 2: Satellite Image of Line 1013 Replacement Project



Pipeline Safety Enhancement Plan Workpaper Supporting Chapter III
LINE 1013 REPLACEMENT PROJECT

Stage 1 – Project Initiation

In workpapers supporting the 2011 PSEP filing,² SoCalGas and SDG&E identified L-1013 as a 3.5 mile transmission pipeline replacement project in the city of Brea. The scope on the original PSEP filing with the CPUC included 3.5 miles, of which approximately 3.456 miles were Category 4 Criteria.

During Stage 1, scope validation verified that:

- L-1013 was first installed in late 1953, with modifications made in 1956 and throughout the years following.
- L-1013 is located in a Class 3 area in the cities of Brea, Fullerton, and Anaheim.
- Most of L-1013 was hydrotested with the exception of a 129-ft segment at 2191 E. Birch Street Brea inside Brea-Olinda Valve Station.

Upon completion of scope validation, the existing hydrotest records supported a scope reduction of Category 4 Criteria mileage from 3.456 miles to 129 feet.

² See December 2, 2011 amended Pipeline Safety Enhancement Plan (PSEP) of SoCalGas and SDG&E.

Pipeline Safety Enhancement Plan Workpaper Supporting Chapter III
LINE 1013 REPLACEMENT PROJECT

Stage 2 – Analysis and Findings

During Stage 2, data analysis was performed and the findings were used to define project scope and to plan tasks for later stages of the project.

Engineering Factors

A PSEP Decision Tree analysis of L-1013 confirmed that the project design should commence as a replacement project because L-1013 scope was less than 1,000 feet. The PSEP Decision Tree directs that scope less than 1,000 feet should be replaced because, under most circumstances, replacements will be the cost effective option. In this instance, there were no conditions that justified overriding this guidance.

Pipeline Safety Enhancement Plan Workpaper Supporting Chapter III
LINE 1013 REPLACEMENT PROJECT

Stage 3 – Initial Planning and Design

During Stage 3, SoCalGas and SDG&E developed a Phase 2 WOA estimate and began field surveys to complete preliminary design drawings and further refine the scope. The scope was increased to include 11 feet of incidental pipe for a total of 140 feet.

In addition to the schedule and estimate, other key activities include identifying all permits, TREs, and easements, defining long lead materials and pricing, understanding customer impacts and interruptions, and preparing any necessary environmental submittals.

Planning and Design Activity

The initial design was planned to replace Category 4 pipe of [REDACTED] diameter with [REDACTED] diameter pipe that feeds off of L-2000. The following details were included in the initial design:

- Replacement of a 140-ft segment of [REDACTED] diameter pipe with [REDACTED] diameter pipe to match the diameter of the existing portion of L-1013 within the station.
- Permanently remove the reducer ([REDACTED]) downstream of the existing [REDACTED] diameter MLV.
- Remove the tapered pipe ([REDACTED]) upstream of the existing [REDACTED] diameter MLV and install a new [REDACTED] diameter reducer to connect to existing L-2000 ([REDACTED]).
- Addition of 11 feet of incidental pipeline to replace the gap where the reducer is removed.
- Install a new [REDACTED] MLV along the 140-ft replaced segment.

Cost Avoidance

- SoCalGas and SDG&E coordinated this replacement project and the Brea Station -1013 Valve Project with respect to installing the new MLV as part of the scope of work for the pipeline replacement. This saved costs and construction resources, and minimized the customer impact since there was only one shut-in. The new MLV was scheduled to be automated at a future date in conjunction with the Brea Station – 1013 Valve Project.

Pipeline Safety Enhancement Plan Workpaper Supporting Chapter III
LINE 1013 REPLACEMENT PROJECT

- SoCalGas and SDG&E coordinated with Cal State Fullerton Facilities Operations to schedule the gas shut-in on the weekend when the university could shut down their natural gas cogeneration equipment without significant impact to their electric service.

Estimate of Costs

The estimated total loaded cost for L-1013 Replacement Project was \$2,028,510, as shown in Table 3. The initial estimate was prepared on March 10, 2014 using the Stage 3 SCG Pipeline Estimate Template Rev 0. Upon receipt of the Contractor’s quote the construction cost was also updated in a pre-construction Phase 2 Reauthorized WOA dated 6/23/14.

Table 3: L-1013 Replacement Project Phase 2 WOA and Phase 2 Reauthorized WOA Estimate

Cost Category	Phase 2 WOA 3/13/14	Re-authorized WOA 6/23/14
Company Labor Costs	\$115,941	\$245,720
Contract Costs	\$692,447	\$1,284,551
Material Costs	\$144,882	\$157,477
Other Direct Costs	\$34,621	\$37,698
Total Direct Costs	\$987,891	\$1,725,446
Total Indirect Costs	\$246,786	\$303,064
Total Loaded Costs	\$1,234,677	\$2,028,510

Pipeline Safety Enhancement Plan Workpaper Supporting Chapter III
LINE 1013 REPLACEMENT PROJECT

Stage 4 – Detailed Engineering Design and Procurement

During Stage 4, detailed design and material procurement was completed in order to provide a construction ready packet to the construction contractor to execute the planned project scope. There were no scope changes between Stage 3 and Stage 4.

Detailed Planning and Design

SoCalGas and SDG&E determined that the tie-in procedure would be most efficient if performed in two separate operations to minimize impact to customers:

- Tie-in at the south end.
 - This tie-in would occur on a weekend and would remove L-1013 from service when Cal State Fullerton’s electrical load would be at a minimum. The university would be able to shut down their natural gas cogeneration equipment without significant impact since electric demand is significantly reduced on the weekends.
- Tie-in at the north end.
 - CNG would be utilized to serve two commercial customers during tie-in activities for L-1013.

Construction Contractor Selection

The construction contractor selection was operating under an established MSA and was chosen for three reasons:

- The contractor’s performance on past SoCalGas projects.
- To evaluate the contractor’s performance for future PSEP projects involving larger diameter high-pressure pipeline in order to have more contractors for this type of work.
- In support of Diverse Business Enterprise goals.

Pipeline Safety Enhancement Plan Workpaper Supporting Chapter III
LINE 1013 REPLACEMENT PROJECT

The Construction Contractor's estimate was \$ [REDACTED], which is \$ [REDACTED] more than the Stage 3 construction contractor direct estimate of \$ [REDACTED] that was used to develop the Phase 2 WOA.

Pipeline Safety Enhancement Plan Workpaper Supporting Chapter III
LINE 1013 REPLACEMENT PROJECT

Stage 5 – Construction

Schedule

Construction Start Date: 07/14/14

NOP Date: 09/25/14

Construction Finish Date: 10/29/14

The construction lasted approximately 14 weeks from mobilization to demobilization instead of the planned 10 weeks.

Field Conditions

Conditions were encountered in the field that were not anticipated during design and planning that had to be addressed or mitigated. Listed below is a summary of the key field changes broken down by type of change for this project:

Constructability Issues:

- An existing MLV approximately a mile south of the tie-in location did not seal completely when shut, causing a delay of the tie-in while arrangements were made to have the valve serviced. This added approximately 1 week to the construction schedule.
- Hand excavation of the trench took longer than expected due to the presence of coal tar wrap which is assumed to contain asbestos. This added approximately 1 week to the construction schedule.
- K-rails were needed on either side of pipe to properly secure the pipe prior to hydrotest. The pipe needed the added security because the pipe was fabricated and hydrotested above ground prior to installation.

Pipeline Safety Enhancement Plan Workpaper Supporting Chapter III
LINE 1013 REPLACEMENT PROJECT

Environmental:

- Coal tar abatement identified after excavation. Disbonded cold tar wrap was discovered in the excavation requiring special abatement mitigation. An industrial hygienist and an abatement crew safely removed the coal tar wrap and properly disposed of it. This added 3 days to the construction schedule.

Schedule Impacts:

- The time needed to repair the non-sealing valve delayed the south tie-in date. This in turn caused a delay of one week for the north tie-in date.

Site Restoration:

- Because of the re-excavation associated with the MLV as discussed above, additional paving/restoration was necessary after repairing the MLV.

Pipeline Safety Enhancement Plan Workpaper Supporting Chapter III
LINE 1013 REPLACEMENT PROJECT

Stages 6 and 7 – Commissioning and Closeout

Commissioning activities included site restoration, final inspections, placement of the pipeline back into service, transportation and disposal of the hydrotested water or hazardous materials and demobilization from the site. Close out activities included development of final drawings, the reconciliation package and updates to company systems to reflect the changes made to the system.

Cost Variance

Table 4: L-1013 Phase 2 Reauthorized WOA and Actual Costs

COST SUMMARY				
	PHASE 2 WOA	CAPITAL (actuals)	DELTA over/(under)	
COMPANY LABOR	\$ 245,720	\$ 303,117	\$	57,397
CONTRACT COSTS	\$ 1,284,551	\$ 1,240,255	\$	(44,296)
MATERIALS	\$ 157,477	\$ 165,066	\$	7,589
OTHER DIRECTS	\$ 37,698	\$ 712,825	\$	675,127
INDIRECTS	\$ 303,064	\$ 316,718	\$	13,654
TOTAL LOADED	\$ 2,028,510	\$ 2,737,981	\$	709,471

Table 4 compares the Phase 2 WOA Reauthorized WOA estimate and the March 2016 total loaded actual costs. The total loaded actual costs exceeded the Phase 2 WOA Reauthorized WOA estimate by \$709,471. The initial WOA estimate was calculated in Stage 3 using the Stage 3 SCG Pipeline Estimate Template Rev 0. Subsequently in Stage 4, the WOA was reauthorized to include an updated scope of work and fixed cost bid from the selected construction contractor.

The above variance is attributable to scope changes and unanticipated conditions that occurred after the Phase 2 WOA estimate (including: schedule delays and additional work caused by valve servicing, the installation of additional safety equipment, hand excavation of the trench, and loose coal tar wrap and associated environmental abatement efforts) and an early cost estimating tool and process which underestimated inspection, engineering, and other support costs. These increased costs were reasonably incurred to complete the pipeline replacement

Pipeline Safety Enhancement Plan Workpaper Supporting Chapter III
LINE 1013 REPLACEMENT PROJECT

and installation of the MLV. Costs associated with the automation of the valve are included in the Brea Station-1013 Valve Project workpaper.

Disallowances

For this replacement project, SoCalGas and SDG&E have identified pipe as being installed post 1955 and lacking records that provide the minimum information to demonstrate compliance with industry standards or regulatory strength testing and recordkeeping requirements then applicable. Of the pipeline that was replaced, 96 feet of Phase 1A pipe are disallowed. Therefore a \$30,770 reduction was made to ratebase calculated by determining the replacement mileage and multiplying the amount by \$1.7 million per mile, which is SoCalGas' and SDG&E's system average cost of pressure testing.

Pipeline Safety Enhancement Plan Workpaper Supporting Chapter III
LINE 1013 REPLACEMENT PROJECT

Conclusion

SoCalGas and SDG&E enhanced the safety of their natural gas system by prudently executing the L-1013 Replacement Project. Through this replacement project, SoCalGas and SDG&E successfully replaced 140 feet of pipe of varying diameter and installation of a MLV in the City of Brea. The project incurred a total loaded project cost of \$2,737,981.

SoCalGas and SDG&E executed this project prudently: maintaining service to customers (through coordination with Cal State Fullerton, SoCalGas and SDG&E were able to minimize customer impact); and safely and efficiently designing and executing the project by reducing scope and coordinating valve enhancement work to realize construction efficiencies and eliminate the cost of additional blowdowns.

SoCalGas and SDG&E's total loaded project cost of \$2,737,981 is reasonable and should be approved (minus acknowledged disallowances). SoCalGas and SDG&E engaged in prudent cost avoidance efforts (e.g., reducing Category 4 Criteria mileage by over 3 miles and realizing cost efficiencies by coordinating PSEP work); engaged in reasonable efforts to promote competitive and market-based rates for contractor services and materials (see Chapter II (Phillips) (approximately 98% of PSEP agreements with contractors and suppliers were either competitively bid or through agreements entered into using market-based rates based on a recent competitive sourcing event)); and used a reasonable amount of company and contractor resources given the 4 week schedule delay and work scope changes (hand excavation, necessary valve servicing, and environmental abatement for disbonded coal tar wrap).

End of L-1013 Replacement Project Workpaper

Pipeline Safety Enhancement Plan Workpaper Supporting Chapter III
LINE 1014 REPLACEMENT PROJECT

Summary

Table 1: Summary of L-1014 Replacement Project

Project Name	L-1014 Replacement Project
WOA Number / Date	91056 / May 15, 2014
City	Lakewood
Original Pipe Diameter/New Diameter	██████████
Construction Start / Finish	October 13, 2014 / November 20, 2014
Loaded Capital Costs	\$ 927,812
Loaded O&M Costs	\$ 0
Total Loaded Project Costs	\$ 927,812
Disallowance	\$ 2,550 (Capital)

Description

Through the L-1014 Replacement Project, SoCalGas and SDG&E enhanced its high-pressure transmission pipeline system by successfully replacing 16 feet of ██████ diameter pipe, as shown in Figures 1 and 2 and Table 2 that describes the project scope as submitted in the 2011 PSEP filing and the final construction mileage.

Examples of cost avoidance actions included:

- By coordinating with a large electric power plant fed from this pipeline, the project was rescheduled to coincide with their planned outage; thereby, avoiding an interruption in service.
- SoCalGas and SDG&E determined two different possible scenarios for this replacement work. To save time and provide flexibility, SoCalGas and SDG&E pre-fabricated a pipe segment that could be used for either of the two tie-in scenarios.

Pipeline Safety Enhancement Plan Workpaper Supporting Chapter III
LINE 1014 REPLACEMENT PROJECT

- Construction began in October 2014 and was completed in November 2014. The L-1014 Replacement Project incurred a total loaded project cost of \$927,812.

Pipeline Safety Enhancement Plan Workpaper Supporting Chapter III
LINE 1014 REPLACEMENT PROJECT

Table 2: L-1014 Replacement Project 2011 PSEP Filing and Final Mileage*

Line 1014	Total Mileage	Criteria Mileage	Accelerated Mileage**	Incidental Mileage
2011 PSEP Filing	0.003 mi.	0.003 mi.	0	0
Total	16 ft.	8 ft.	8 ft.	0

*Values may not add to total due to rounding.

**Accelerated mileage includes Phase 1B and Phase 2 pipe. Phase 2 includes pipelines without sufficient record of a pressure test in less populated areas (Phase 2A) or pipelines with record of a pressure test, but without record of a pressure test to modern – Subpart J – standards (Phase 2B). Included in this project was 8 feet of pipe accelerated from SoCalGas and SDG&E’s PSEP Phase 2B. This Phase 2B footage was included to realize efficiencies and to enhance project constructability.

Pipeline Safety Enhancement Plan Workpaper Supporting Chapter III
LINE 1014 REPLACEMENT PROJECT

Figure 1: Overview Map of L-1014 Replacement Project

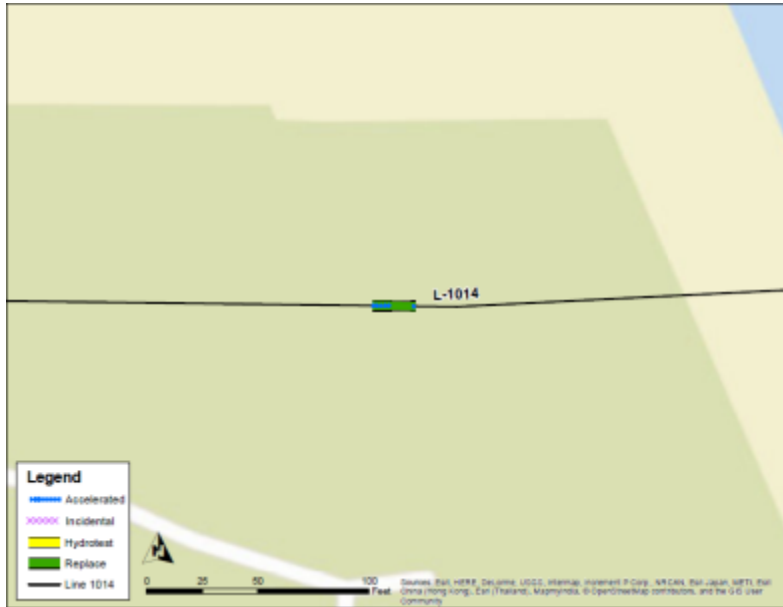


Figure 2: Satellite Image of L-1014 Replacement Project



Pipeline Safety Enhancement Plan Workpaper Supporting Chapter III
LINE 1014 REPLACEMENT PROJECT

Stages 1 & 2 – Project Initiation / Analysis and Findings

In workpapers supporting the 2011 PSEP filing,¹ SoCalGas and SDG&E identified the L-1014 project as a 16 foot replacement project. L-1014 is a 23.44 mile high pressure transmission pipeline of 30-in diameter pipe in the City of Lakewood.

Scope validation confirmed that in 1959, SoCalGas and SDG&E installed 8 feet of [REDACTED] pipe in order to replace a [REDACTED] valve assembly on the west side of the San Gabriel River on Del Amo Boulevard. However, test documentation could not be located for the 8 feet of pipe.

Upon completion of scope validation, the initial scope of 16 feet CAT 4 was reduced to 8 feet. The location for this 8 foot section is in Mae Boyar Park in the City of Lakewood.

Engineering Factors

A PSEP Decision Tree analysis of L-1014 Replacement Project confirmed the project design should commence as a replacement project because the scope was less than 1,000 feet. The PSEP Decision Tree directs that scope less than 1,000 feet should be replaced because, under most circumstances, replacements will be the cost effective option. In this instance there were no conditions that justified overriding this guidance.

¹ See December 2, 2011 Amended Pipeline Safety Enhancement Plan (PSEP) of SoCalGas and SDG&E.

Pipeline Safety Enhancement Plan Workpaper Supporting Chapter III
LINE 1014 REPLACEMENT PROJECT

Stage 3 – Initial Planning and Design

During Stage 3, SoCalGas and SDG&E developed a Phase 2 WOA estimate, and began field surveys to complete preliminary design drawings and further refine scope.

In addition to the schedule and estimate, other key activities include identifying all permits, TRES, and easements, defining long lead materials and pricing, understanding customer impacts and interruptions, and preparing any necessary environmental submittals.

Planning and Design Activity

The initial engineering and design for L-1014 Replacement Project was planned to occur as follows:

- Excavation to expose the pipeline and complete shoring installation.
- Fabrication of a 40-ft length of [REDACTED] diameter pipe with a [REDACTED] diameter cap at one end, and a [REDACTED] diameter test-head at the other end.
- Hydrotesting of the fabrication replacement section.
- Tie-in procedures to consist of a hot tie-in which required the installation of two 2-inch half-couplings located 3-ft beyond each end of the cut pipe.

Additional Considerations

The PSEP team identified a potential risk of schedule delay due to another utility project that needed to remove their equipment in the vicinity of the replacement section.

Estimate of Costs

The Phase 2 WOA estimated cost for the 8 foot replacement section was \$550,246 as shown in Table 3 and is based on preliminary designs. The estimate was prepared on May 15, 2014 using the Stage 3 SCG Pipeline Estimate Template Rev 0.

Pipeline Safety Enhancement Plan Workpaper Supporting Chapter III
LINE 1014 REPLACEMENT PROJECT

Table 3: L-1014 Replacement Project Phase 2 WOA Estimate

Cost Category	Phase 2 WOA
Company Labor Costs	\$ 49,915
Contract Costs	\$ 347,874
Material Costs	\$ 24,363
Other Direct Costs	\$ 31,295
Total Direct Costs	\$ 453,447
Total Indirect Costs	\$ 96,799
Total Loaded Costs	\$ 550,246

Pipeline Safety Enhancement Plan Workpaper Supporting Chapter III

LINE 1014 REPLACEMENT PROJECT

Stage 4 – Detailed Engineering Design and Procurement

During Stage 4, detailed design and material procurement was completed in order to provide a construction ready packet to the construction contractor to execute the planned project scope. There were no changes to scope between Stages 3 and 4.

Detailed Planning and Design

SoCalGas and SDG&E identified the possibility of an existing miter bend near the west end of the replacement section. SoCalGas prepared 40-ft of pipe and fabricated one end to have a 2.5° section of a 90° 3R segmental elbow (in case the miter was exposed). The other end of the fabrication would be straight pipe (in case the miter bend wasn't exposed). Therefore, depending on which scenario was encountered, the correct end of the pipe could be used. If it was not used, the remaining segmental elbow would be returned to inventory and available for use on another project. Preparing a fabrication that could be used for both scenarios saved the company time and provided flexibility for the tie-in.

Additional Considerations

The construction start date for L-1014 Replacement Project was delayed 8 weeks while waiting for another utility to remove its electrical facilities in the vicinity of the replacement section. That removal was not completed until late October; postponing L-1014's planned construction start date to the first week in November 2014.

Additionally, SoCalGas and SDG&E assessed customer impact from the isolation of L-1014. It was determined that there was sufficient capacity to maintain service to core and firm noncore customers, unless power generators in the area ramped up to their maximum usage on an hourly basis. If this occurred, it would trigger a curtailment of interruptible noncore customers to support core and firm noncore customers. SoCalGas and SDG&E coordinated with these customers to avoid a loss of supply to the customers.

SoCalGas and SDG&E planned to schedule the PSEP work to coincide with an electric generator's (EG) planned maintenance which would shut down one generator. This would

Pipeline Safety Enhancement Plan Workpaper Supporting Chapter III
LINE 1014 REPLACEMENT PROJECT

provide a mutually beneficial opportunity to perform this work with the least amount of potential for customer impact and reduced the risk of additional project costs.

Construction Contractor Selection

The selected Signatory Contractor was operating under an established MSA and was utilized for this project for two reasons:

- The contractor's performance on past SoCalGas projects.
- To evaluate the contractor's performance for future PSEP projects involving larger diameter high-pressure pipeline in order to have more contractors for this type of work.
- In support of Diverse Business Enterprise goals.

The Construction Contractor "not to exceed" was \$ [REDACTED] which is \$ [REDACTED] more than the Stage 3 construction contractor direct estimate of \$ [REDACTED] that was used to develop the Phase 2 WOA.

Pipeline Safety Enhancement Plan Workpaper Supporting Chapter III
LINE 1014 REPLACEMENT PROJECT

Stage 5 – Construction

Schedule

Construction Start Date: 10/13/2014

NOP Date: 11/04/2014

Construction Finish Date: 11/20/2014

SoCalGas used the fabrication end with the straight pipe and not the fabricated side with the 90° 3R elbow cut to 2.5. The remaining segmental elbow was returned to inventory and available for use on another project.

Upon excavating the section, two wedding bands and fire control fittings were identified on both ends of the replacement section. An additional 8 feet of pipe was added to the scope to replace the existing wedding bands and fire control fittings. The replacement project's new scope of work entailed 16 feet.

Field Conditions

Conditions were encountered in the field that were not anticipated during design and planning that had to be addressed or mitigated. Listed below is a summary of the key field changes broken down by type of change for this project.

Weekend work:

- The project was mobilized on a Sunday which increased the cost of tie-in activities which started immediately after blowdown of the line. This was due to a small window of time to avoid a possible power plant curtailment. This work avoided a potential curtailment.

Weather:

- Several days of rain delayed the schedule by one week.

Pipeline Safety Enhancement Plan Workpaper Supporting Chapter III
LINE 1014 REPLACEMENT PROJECT

Stages 6 and 7 – Commissioning and Closeout

Commissioning activities included site restoration, final inspections, and placement of the pipeline back into service, transportation and disposal of the hydrotested water or hazardous material and demobilization from the site. Close out activities included development of final drawings, the reconciliation package and updates to company systems to reflect the changes made to the system.

Cost Variance

Table 4: L-1014 Replacement Project Phase 2 WOA Estimate and Actual Costs

COST SUMMARY				
	PHASE 2 WOA	CAPITAL (actuals)	DELTA over/(under)	
COMPANY LABOR	\$ 49,915	\$ 98,253	\$	48,338
CONTRACT COSTS	\$ 347,874	\$ 274,441	\$	(73,433)
MATERIALS	\$ 24,363	\$ 20,589	\$	(3,774)
OTHER DIRECTS	\$ 31,295	\$ 420,765	\$	389,470
INDIRECTS	\$ 96,799	\$ 113,763	\$	16,964
TOTAL LOADED	\$ 550,246	\$ 927,812	\$	377,566

Table 4 compares the Phase 2 WOA estimate and the March 2016 total loaded actual costs. The total loaded actual costs were \$377,566 more than the Phase 2 WOA estimate.

The difference between the WOA and the total loaded actual costs is attributable to scope changes that occurred after the Phase 2 WOA estimate and unanticipated conditions during construction (including: scope increase to replace existing wedding bands and fire control fittings; weather delays; Sunday mobilization to schedule work to coincide with an EG’s planned maintenance and minimize customer impacts; schedule delays stemming from the need to remove electric facilities); and an early cost estimating tool and process that was based on preliminary project designs (resulting in underestimating of project support services, company labor, certain construction activities, and closeout activities). These increased costs were reasonably incurred to complete this replacement work, but were not accounted for in the Stage 3 estimate.

Pipeline Safety Enhancement Plan Workpaper Supporting Chapter III
LINE 1014 REPLACEMENT PROJECT

Disallowances

For this replacement project, SoCalGas and SDG&E have identified pipe as being installed post 1955 and lacking pressure test records that provide the minimum information to demonstrate compliance with industry standards or regulatory strength testing and recordkeeping requirements then applicable. Of the pipeline that was replaced, 8 feet of Phase 1A pipe are disallowed. Therefore a \$2,550 reduction was made to ratebase calculated by determining the replacement mileage and multiplying the amount by \$1.7 million per mile, which is SoCalGas' and SDG&E's system average cost of pressure testing.

Pipeline Safety Enhancement Plan Workpaper Supporting Chapter III
LINE 1014 REPLACEMENT PROJECT

Conclusion

SoCalGas and SDG&E enhanced the safety of their natural gas system by prudently executing the L-1014 Replacement Project. Through this replacement project, SoCalGas and SDG&E successfully replaced 16 feet of pipe of [REDACTED] diameter in the City of Lakewood. The project incurred a total loaded project cost of \$927,812.

SoCalGas and SDG&E executed this project prudently: maintaining service to core customers through coordination with an electric generation customer; responding prudently to unknown conditions (preparing a fabrication that would allow the flexibility no matter the situation); and responding to numerous unanticipated field changes including project delays and the need to double the length of pipe to be addressed to replace existing wedding bands and fire control fittings.

SoCalGas and SDG&E's total loaded project cost of \$927,812 is reasonable and should be approved (minus acknowledged disallowances). SoCalGas and SDG&E engaged in prudent cost avoidance efforts; engaged in reasonable efforts to promote competitive and market-based rates for contractor services and materials (see Chapter II (Phillips) (approximately 98% of PSEP agreements with contractors and suppliers were either competitively bid or through agreements entered into using market-based rates based on a recent competitive sourcing event)); and used a reasonable amount of company and contractor resources given the numerous scope changes and delays.

End of L-1014 Replacement Project Workpaper

■

Pipeline Safety Enhancement Program Workpaper Supporting Chapter III
LINE 1015 HYDROTEST PROJECT

Summary

Table 1: Summary of L-1015 Hydrotest Project

Project Name	L-1015 Hydrotest Project
WOA Number / Date	25377 / May 12, 2014 91076 / May 12, 2014
Cities	Orange and Santa Ana
Original Pipe Diameter/New Diameter	██████████
Construction Start / Finish	August 6, 2014 / February 4, 2015
Loaded Capital Costs	\$ 480,991
Loaded O&M Costs	\$ 5,241,278
Total Loaded Project Costs	\$ 5,722,269
Disallowances	\$ 3,071,282 (O&M) \$7,480 (Capital)

Description

L-1015 is a 7.8 mile transmission pipeline that runs through the cities of Santa Ana and Orange. Through the L-1015 Project, SoCalGas and SDG&E enhanced its high-pressure transmission pipeline system by successfully pressure testing 0.4094 miles of pipe, as shown in Figures 1 through Figure 6 and Table 2 that describe the project scope as submitted in the 2011 PSEP filing and the final mileage. This project consisted of two separate work locations identified as the North and South sections.

Examples of cost avoidance actions included:

- Through records validation L-1015 Category 4 Criteria miles decreased from 7.821 miles to 1,299 feet.
- Coordinated efforts with Pipeline Integrity department to share an existing laydown yard and expand an encroachment permit to include the PSEP scope of work.
- Negotiated with the City of Santa Ana to use city-owned property as a laydown for a nominal fee.

Pipeline Safety Enhancement Program Workpaper Supporting Chapter III
LINE 1015 HYDROTEST PROJECT

- Reuse of test heads on L-1015 North Section that were fabricated for L-1015 South Section.

Construction began in August 2014 on the South Section followed by the North Section in October 2014. Both sections were successfully hydrotested and all construction completed by February 2015. The L-1015 Hydrotest Project incurred a total loaded project cost of \$5,722,269.

Table 2: L-1015 Hydrotest Project - PSEP Filing and Final Mileage*

Line 1015	Total Mileage	Criteria Mileage	Accelerated Mileage	Incidental Mileage
2011 PSEP Filing	7.845 mi.	7.821 mi.	0.024 mi.	0
Final Project Mileage				
South	1,799 ft.	1,214 ft.	565 ft.	20 ft.
North	362 ft.	76 ft.	286 ft.	0
Total	2,161 ft.	1,290 ft.	851 ft.	20 ft.

*Values may not add to total due to rounding.

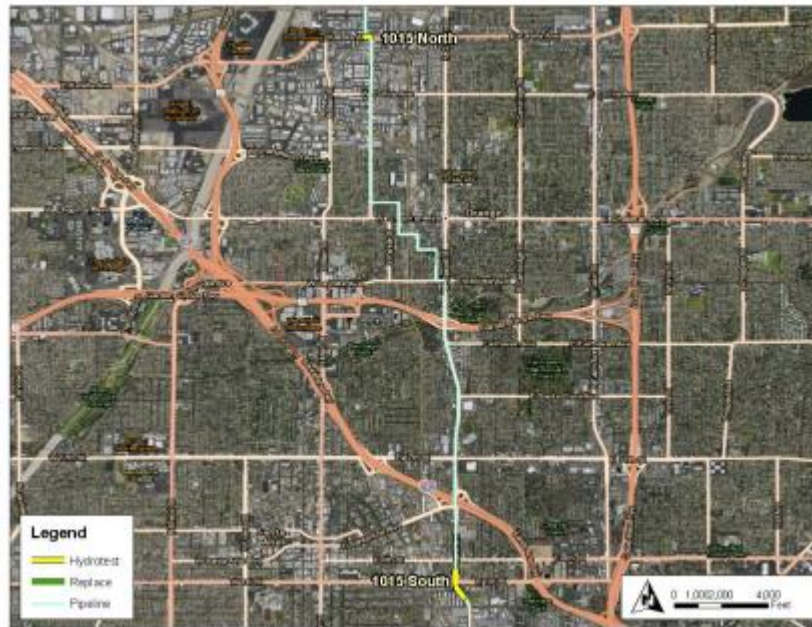
**Accelerated mileage includes Phase 1B and Phase 2 pipe. Phase 2 includes pipelines without sufficient record of a pressure test in less populated areas (Phase 2A) or pipelines with record of a pressure test, but without record of a pressure test to modern – Subpart J – standards (Phase 2B). Included in this project was 851 feet of pipe accelerated from SoCalGas and SDG&E’s PSEP Phase 2B. This Phase 2B footage was included to realize efficiencies and to enhance project constructability.

Pipeline Safety Enhancement Program Workpaper Supporting Chapter III
LINE 1015 HYDROTEST PROJECT

Figure 1: Overview Map of L-1015 Hydrotest Project



Figure 2: Overview Satellite Image of L-1015 Hydrotest Project



Pipeline Safety Enhancement Program Workpaper Supporting Chapter III

LINE 1015 HYDROTEST PROJECT

Stage 1 – Project Initiation

In workpapers supporting the 2011 PSEP filing,¹ SoCalGas and SDG&E identified the L-1015 Project as a Phase 1A replacement project. It comprised approximately 7.821 Category 4 Criteria miles and 0.024 accelerated miles.

During Stage 1, SoCalGas and SDG&E performed scope validation for L-1015 verifying that:

- L-1015 consists of mostly [REDACTED] diameter pipe that was installed in 1954, with modifications made throughout subsequent years.
- Pipeline Integrity had previously identified portions of L-1015 for replacement to enable piggability. A 1,111-foot section of pipe along the East Lincoln Avenue Bridge in the City of Orange was currently being replaced.

Scope validation reduced the scope of the Category 4 Criteria mileage from 7.821 miles to 0.246 miles.

¹ See December 2, 2011 Amended Pipeline Safety Enhancement Plan (PSEP) of SoCalGas and SDG&E.

Pipeline Safety Enhancement Program Workpaper Supporting Chapter III

LINE 1015 HYDROTEST PROJECT

Stage 2 – Analysis and Findings

During Stage 2, data analysis was performed and the findings were used to define project scope and to plan tasks for later stages of the L-1015 Project.

Engineering Factors

South Section

SoCalGas and SDG&E determined that a 1,213 foot pipeline segment for the South Section should be hydrotested for the following reasons:

- The ILI report found the transmission pipeline to be in good condition.
- The pipeline is 1954 vintage and slightly more than 1,000 feet in length. SoCalGas and SDG&E confirmed it to be a hydrotest project because it was greater than 1,000 feet, had manageable customer impacts and had no engineering factors supporting replacement.

North Section

Based on the PSEP Decision Tree, SoCalGas and SDG&E confirmed that the North Section project design should commence as a replacement project because the section's scope was less than 1,000 feet. The PSEP Decision Tree directs that scope less than 1,000 feet should be replaced because, under most circumstances, replacements are the effective option. In this instance there were no conditions that justified overriding this guidance.

Pipeline Safety Enhancement Program Workpaper Supporting Chapter III

LINE 1015 HYDROTEST PROJECT

Stage 3 – Initial Planning and Design

During Stage 3, SoCalGas and SDG&E developed a Phase 2 WOA estimate, and began field surveys to complete preliminary design drawings and further refine scope.

In addition to the schedule and estimate, other key activities include identifying all permits, TREs, and easements, defining long lead materials and pricing, understanding customer impacts and interruptions, and preparing any necessary environmental submittals.

Planning and Design Activity

South Section

During Stage 3, SoCalGas and SDG&E determined the following:

- Relocation of the hydrotest heads was needed to minimize impacts on traffic during construction. The re-designed scope moved the hydrotest heads from the south side of E. First Street, to the north side of E. First Street. The change in the start point added 200 feet of pipe to the South Section hydrotest segment increasing length of the South Section to 1,433 feet.

North Section

During Stage 3, SoCalGas and SDG&E determined the following:

- The initial design for the North Section replacement project was to bore under the storm culvert at the intersection of Katella Avenue and Batavia Street and install 170 feet of new [REDACTED] pipeline and abandon 76-foot pipeline under the storm culvert at the intersection. However, as SoCalGas and SDG&E continued their research and design process, it was determined that the initial design was not viable because the property owners adjacent to the construction site refused to grant SoCalGas a TRE to allow for excavations. Further complicating the design was the discovery that an undeveloped site, originally scouted for excavating the bore pits, was currently under construction as the site of a new restaurant.

Pipeline Safety Enhancement Program Workpaper Supporting Chapter III

LINE 1015 HYDROTEST PROJECT

- SoCalGas and SDG&E developed an alternate plan that would confine the excavations to city streets. However this would involve appropriating a site for excavating the bore pits and required a 230-foot diagonal bore under the storm culvert, increasing the project scope from 170 feet to 400 feet. In evaluating the options and this new information, it was decided that, in this instance, hydrotesting this short section of pipe was the more cost effective solution because of the added costs due to the more complex engineering design associated with replacement. Customer impacts were manageable and there were no known conditions that would preclude the line from being hydrotested. The modified engineering design for the North Section hydrotest would test a 350 foot pipeline segment, with the northern test head being installed at the northwest side of the intersection at W. Katella Avenue and N. Batavia Streets to minimize traffic.

Additional Considerations

North Section

SoCalGas identified a [REDACTED] tap valve serving an adjacent regulator station that was located in the middle of the intersection. Relocating the tap valve 109 feet north from its existing location was the best option for safety and accessibility reasons because:

- The hydrotest could not be performed without isolating the valve in its current location. The valve would have to be excavated and separated from the inlet piping at the regulator station to safely perform the hydrotest analysis at the North Section location.
- The new location of the valve would be in an excavation that was already being used for the hydrotest construction; therefore, relocation would incur minimal cost.
- The valve was in the middle of high-traffic Katella Avenue and difficult to access. The valve would be moved to the northwest side of the intersection at W. Katella Avenue and N. Batavia Street.

Pipeline Safety Enhancement Program Workpaper Supporting Chapter III
LINE 1015 HYDROTEST PROJECT

Estimate of Costs

SoCalGas and SDG&E estimated the total loaded cost at the end of Stage 3 to be \$3,522,930, as shown in Table 3. This estimate was prepared on May 1, 2014 using the Stage 3 SCG Pipeline Estimate Template Rev 0 estimating tool and was based on preliminary designs.

Table 3: L-1015 Hydrotest Project Phase 2 WOA Estimate

Cost Category	Phase 2 WOA
Company Labor Costs	\$380,532
Contract Costs	\$1,249,202
Material Costs	\$164,723
Other Direct Costs	\$1,322,743
Total Direct Costs	\$3,117,200
Total Indirect Costs	\$405,730
Total Loaded Costs	\$3,522,930

Pipeline Safety Enhancement Program Workpaper Supporting Chapter III

LINE 1015 HYDROTEST PROJECT

Stage 4 – Detailed Engineering Design and Procurement

During Stage 4, detailed design and material procurement was completed in order to provide a construction ready packet to the construction contractor to execute the planned project scope. The following scope changes occurred during this stage.

Detailed Planning and Design

South Section

SoCalGas learned that the City of Santa Ana was planning a street widening project that would be located along S. Grand Avenue in the same location as the South Section hydrotest project. In order to facilitate the construction of the South Section hydrotest so that the city street widening project could begin as scheduled, a design change was agreed upon to increase the length of the South Section hydrotest segment by one street block. This design change also allowed SoCalGas to utilize an adjacent city property as the northern laydown yard for pipeline fabrication and staging of equipment for construction and hydrotest which was also a cost avoidance measure. The design change was planned to occur as follows:

- Move the hydrotest head from the north side of E. First Street to the new laydown yard at the city property at the northwest side of E. Second Street.
- Conduct the hydrotest along 1,827 feet of pipeline, commencing at the new hydrotest start point at E. Second Street:
 - The change in the hydrotest start point would add 366 ft. of pipe to the South Section hydrotest segment.

Pipeline Safety Enhancement Program Workpaper Supporting Chapter III
LINE 1015 HYDROTEST PROJECT

Detailed Planning and Design

North Section

There were no scope changes for the North Section from Stage 3 to Stage 4

Cost Avoidance

- Coordination with Pipeline Integrity department to share their laydown yard for the southern area and expand the encroachment permit on a project taking place at the intersection of Chestnut and Grand in Santa Ana.
- It was determined that the test heads on the L-1015 South Section that were fabricated during construction could be reused for L-1015 North Section.

Construction Contractor Selection

Construction of both sections for L-1015 was managed by the PSEP Performance Partner.

The Performance Partner/Construction Contractor TPE was \$ [REDACTED] which is \$ [REDACTED] more than the Stage 3 construction contractor direct cost estimate of \$ [REDACTED] that was used to develop the Phase 2 WOA.

Pipeline Safety Enhancement Program Workpaper Supporting Chapter III
LINE 1015 HYDROTEST PROJECT

Stage 5 – Construction

South Section

Schedule

Construction Start Date: 08/06/2014

NOP Date: 09/04/2014

Construction Finish Date: 09/29/2014

The construction lasted 6 weeks from mobilization to demobilization. The hydrotest was performed from August 25, 2014 through August 26, 2014 and the pipeline was returned to service on September 4, 2014.

Field Conditions

Conditions were encountered in the field that were not anticipated during design and planning that had to be addressed or mitigated. Listed below is a summary of the key field changes broken down by type of change for this section:

Construction Unknowns:

- The Project team added 4 feet to the South Section excavation site at E. Chestnut and S. Grand Avenues to install a secondary fire control fitting in order to decrease the risk of operational and safety issues during the tie-in operation.

Schedule Delay:

- The tie-in work lasted 24 hours instead of the initial estimate of 16 hours. The costs associated with the extended tie-in work and delays increased construction costs.

Pipeline Safety Enhancement Program Workpaper Supporting Chapter III

LINE 1015 HYDROTEST PROJECT

North Section

Schedule

Construction Start Date: 10/14/2014

NOP Date: 12/10/2014

Construction Finish Date: 02/04/2015

The hydrotest was performed on November 24, 2014 and returned to service on December 10, 2014. The work took approximately 2 weeks longer than expected due to the conditions discussed below.

Field Conditions

Conditions were encountered in the field that were not anticipated during design and planning that had to be addressed or mitigated. Listed below is a summary of the key field changes broken down by type of change for this section:

Access:

- Operating department personnel were diverted to immediate operational needs and therefore, were not available to assist with the hot line as scheduled. This caused a one-week delay.

Weather:

- Rain delayed the tie-in and restoration of service to the pipeline by one week which also delayed demobilization.

Pipeline Safety Enhancement Program Workpaper Supporting Chapter III
LINE 1015 HYDROTEST PROJECT

Constructability Issues:

- The 2-inch tap extension that was relocated to the north side of Katella Avenue and Batavia Street was tied in to the existing 2-inch pipe and nitrogen tested up to the existing regulator station on the south side of Katella and Batavia Street. This was done to simplify gas handling procedures.

Schedule Delay:

- SoCalGas crews mobilized and then postponed a tie-in due because the main line valve not completely sealing. The tie-in was delayed a week while the valve was being serviced.

Pipeline Safety Enhancement Program Workpaper Supporting Chapter III

LINE 1015 HYDROTEST PROJECT

Stages 6 and 7 – Commissioning and Closeout

Commissioning activities included site restoration, final inspections, and placement of the pipeline back into service, transportation and disposal of the hydrotested water or hazardous material and demobilization from the site. Close out activities included development of final drawings, the reconciliation package and updates to company systems to reflect the changes made to the system.

Cost Variance

Table 4: L-1015 Hydrotest Project Phase 2 WOA Estimate and Actual Costs

COST SUMMARY				
	PHASE 2 WOA	O&M (actuals)	CAPITAL (actuals)	DELTA over/(under)
COMPANY LABOR	\$ 380,532	\$ 360,118	\$ 14,446	\$ (5,969)
CONTRACT COSTS	\$ 1,249,202	\$ 2,439,601	\$ 284,837	\$ 1,475,236
MATERIALS	\$ 164,723	\$ 113,849	\$ 16,123	\$ (34,751)
OTHER DIRECTS	\$ 1,322,743	\$ 1,935,876	\$ 125,349	\$ 738,482
INDIRECTS	\$ 405,730	\$ 391,834	\$ 40,237	\$ 26,341
TOTAL LOADED	\$ 3,522,930	\$ 5,241,278	\$ 480,991	\$ 2,199,340

The March 2016 total loaded actual cost incurred to complete L-1015 Project was \$5,722,269 for O&M and Capital which was \$2,199,340 more than the Phase 2 WOA estimate. This project includes \$480,991 of capital costs for four tie-in pieces and the one cut out of a drip, the five segments totaled 89 feet of pipe.

The difference between the WOA and the actual costs is attributable to scope changes that occurred after the Phase 2 WOA estimate and unknown conditions experienced during construction (including: design and schedule changes to respond to the City of Santa Ana’s street-widening project; schedule delays resulting from additional tie-in work, weather, and resource availability); and an early cost estimating tool and process that was based on preliminary project designs (resulting in underestimating of the construction contractor costs, engineering and design costs, and other support costs). These increased costs were reasonably incurred to complete this replacement work, but were not accounted for in the Stage 3 estimate.

Pipeline Safety Enhancement Program Workpaper Supporting Chapter III

LINE 1015 HYDROTEST PROJECT

Disallowances

For this hydrotest project, SoCalGas and SDG&E have identified a total of 0.244 miles of pipe as being installed post 1955 and lacking pressure test records that provide the minimum information to demonstrate compliance with industry standards or regulatory strength testing and recordkeeping requirements then applicable. Of the .409 miles of pipeline that was pressure tested, 0.244 ~~0.240~~ miles (59%) of Phase 1A pipe is disallowed, therefore \$3,071,282 (59%) of the total project O&M costs are disallowed from recovery. In addition, of the pipeline that was replaced, 23 feet of Phase 1A pipe are disallowed. Therefore a \$7,480 reduction was made to ratebase calculated by determining the replacement mileage and multiplying the amount by \$1.7 million per mile, which is SoCalGas' and SDG&E's system average cost of pressure testing.

Pipeline Safety Enhancement Program Workpaper Supporting Chapter III

LINE 1015 HYDROTEST PROJECT

Conclusion

SoCalGas and SDG&E enhanced the safety of their natural gas system by prudently executing the L-1015 Hydrotest Project. Through this hydrotest project, SoCalGas and SDG&E successfully hydrotested .4094 miles in the City of Orange and Santa Ana. The project incurred a total loaded project cost of \$5,722,269 for O&M and Capital.

SoCalGas and SDG&E executed this project prudently: maintaining service to core customers; prudently designed the project (hydrotesting the North section to simplify the design and work, expanding the South section so as to not conflict with Santa Ana City work, and relocating a tap valve to improve safety and accessibility); and reasonably responded to unknown conditions (rain delays and resource availability) and schedule delays.

SoCalGas and SDG&E's total loaded project cost of \$5,722,269 for O&M and capital is reasonable and should be approved (minus acknowledged disallowances). SoCalGas and SDG&E engaged in prudent cost avoidance efforts (e.g., reducing Category 4 Criteria mileage by over 7 miles, working with Pipeline Integrity to share a laydown yard and expand their permit, work with the city to use their property as laydown yard and respond to a city planned street-widening project, and reuse of test heads for the North and South sections); engaged in reasonable efforts to promote competitive and market-based rates for contractor services and materials (see Chapter II (Phillips)(approximately 98% of PSEP agreements with contractors and suppliers were either competitively bid or through agreements entered into using market-based rates based on a recent competitive sourcing event)); and used a reasonable amount of company and contractor resources given the project's complexity, work scope changes, and delays.

End of L-1015 Hydrotest Project Workpaper

Pipeline Safety Enhancement Plan Workpaper Supporting Chapter III
LINE 2000 WEST HYDROTEST PROJECT

Summary

Table 1: L-2000 West Hydrotest Project Summary

Project Name	L-2000 West Hydrotest Project
WOA Numbers/WOA Date	91035 and 25736 / July 17, 2014
Cities:	Whittier, Santa Fe Springs, Pico Rivera, City of Commerce
Original Pipe Diameter	██████████
Construction Start	July 21, 2014
Construction Finish	January 30, 2015
Loaded Capital Costs	\$8,435,767
Loaded O&M Costs	\$16,403,065
Total Loaded Project Costs	\$24,838,832
Disallowances	\$68,470 (O&M) \$1,020 (Capital)

Background

Line 2000 is an approximately 225-mile transmission pipeline of varying diameter ██████████ ██████████ that transports gas from the California/Arizona border at Blythe to the Los Angeles Basin. SoCalGas and SDG&E separated the L-2000 Project into four separate projects: L-2000-A, L-2000-B, L-2000-C and L-2000-West because of the disparate locations of Category 4 segments along the length of the pipeline and for constructability reasons. This workpaper describes activity and costs related to the L-2000-West project only. L-2000-A was previously submitted to the CPUC for cost recovery as part of the Application 14-12-016 filing; L-2000-B and L-2000-C workpapers will be submitted in a future reasonableness review application.

Description

Through the L-2000 West Hydrotest Project, SoCalGas and SDG&E enhanced their high-pressure transmission pipeline system by successfully hydrotesting 14.5 miles of pipeline, as

Pipeline Safety Enhancement Plan Workpaper Supporting Chapter III

LINE 2000 WEST HYDROTEST PROJECT

shown in Figures 1 through 8 and in Table 2 that describes the project scope as submitted in the 2011 PSEP filing and the final mileage

Given the location of the L-2000 West Category 4 segments and the overall project location and length, the hydrotest was performed in three separate sections: Whittier-1, Pico Rivera-2, and Commerce-3.

Examples of L-2000 West Project cost avoidance actions included:

- For L-2000 (Sections A, B, C, W), scope validation reduced Category 4 Criteria mileage from 55.027 to 34.174 miles.
- Shared worksites between hydrotest sections reduced costs.
- Lake tank was used in place of water storage tanks which resulted in a cost savings (see Figure 9).
- Reuse of water for each hydrotest reduced costs.
- Efficient project design added accelerated and incidental footage to combine continuous Category 4 segments in the hydrotests to save construction time in the field, reduce mobilization and demobilization costs and minimize impacts to the community

Construction began in July 2014 and the last of the three tests was successfully completed in January 2015 for a total loaded project cost of \$24,838,832.

Pipeline Safety Enhancement Plan Workpaper Supporting Chapter III
LINE 2000 WEST HYDROTEST PROJECT

Table 2: L-2000-West PSEP Filing and Final Mileage*

Line 2000	Total Mileage	Criteria Mileage	Accelerated Mileage**	Incidental Mileage
2011 PSEP Filing (2000 Sections A, B, C and West)	117.6 mi.	55.027 mi.	62.574 mi.	0
L-2000-West				
Whittier-1	4.196 mi	417 ft.	4.116 mi.	5 ft.
Pico Rivera-2	5.597 mi	4.759 mi.	0	0.838 mi.
Commerce-3	4.778 mi	3.894 mi.	0	0.884 mi.
Total	14.571 mi.	8.731 mi.	4.116 mi.	1.723 mi.

*Values may not add to total due to rounding.

**Accelerated mileage includes Phase 1B and Phase 2 pipe. Phase 2 includes pipelines without sufficient record of a pressure test in less populated areas (Phase 2A) or pipelines with record of a pressure test, but without record of a pressure test to modern – Subpart J – standards (Phase 2B). Included in this project was 4.116miles of pipe accelerated Phase 2B. The accelerated mileage was included to realize efficiencies and to enhance project constructability.

Pipeline Safety Enhancement Plan Workpaper Supporting Chapter III
LINE 2000 WEST HYDROTEST PROJECT

Figure 1: Overview Map of L-2000 West Hydrotest Project



Figure 2: Satellite Image of L-2000 West Hydrotest Project

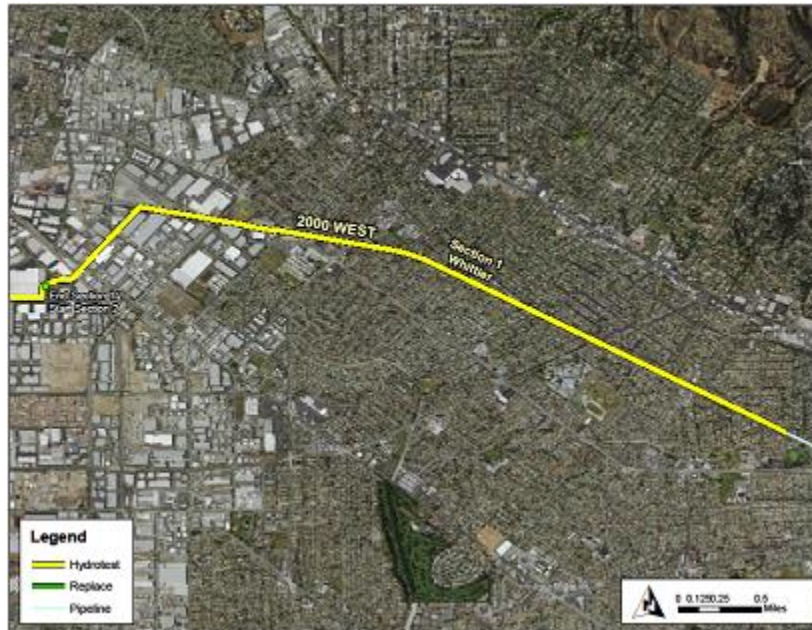


Pipeline Safety Enhancement Plan Workpaper Supporting Chapter III
LINE 2000 WEST HYDROTEST PROJECT

Figure 3: Overview Map of L-2000 West Hydrotest Project - Section 1 Whittier



Figure 4: Satellite Image of L-2000 West Hydrotest Project - Section 1 Whittier

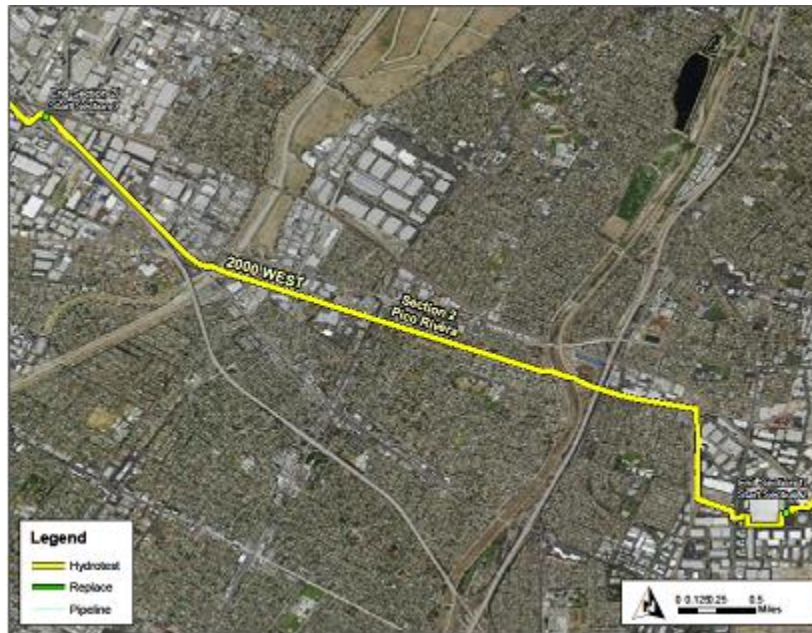


Pipeline Safety Enhancement Plan Workpaper Supporting Chapter III
LINE 2000 WEST HYDROTEST PROJECT

Figure 5: Overview Map of L-2000 West Hydrotest Project Section 2 Pico Rivera



Figure 6: Satellite Image of L-2000 West Hydrotest Project - Section 2 Pico Rivera



Pipeline Safety Enhancement Plan Workpaper Supporting Chapter III
LINE 2000 WEST HYDROTEST PROJECT

Figure 7: Overview Map of L-2000 West Hydrotest Project - Section 3 Commerce



Figure 8: Satellite Image of L-2000 West Hydrotest Project - Section 3 Commerce



Pipeline Safety Enhancement Plan Workpaper Supporting Chapter III
LINE 2000 WEST HYDROTEST PROJECT

Stage 1 – Project Initiation

In workpapers supporting the 2011 PSEP filing,¹ SoCalGas and SDG&E identified the L-2000 Project as a 117 mile Phase 1A project. It comprised approximately 55 Category 4 Criteria Miles and 63 Accelerated Miles.

Subsequent research and analysis revised the scope of the project reducing Category 4 Criteria mileage for all of the 2000 Project from 55.027 to 34.174 miles. Due to the disparate location of Category 4 segments along the length of the pipeline, as well as for constructability reasons, SoCalGas and SDG&E separated the L-2000 Project into four separate projects: L-2000-A, L-2000-B (Bridge), L-2000-C and L-2000-West.

¹ See December 2, 2011 Amended Pipeline Safety Enhancement Plan (PSEP) of SoCalGas and SDG&E.

Pipeline Safety Enhancement Plan Workpaper Supporting Chapter III

LINE 2000 WEST HYDROTEST PROJECT

Stage 2 – Analysis and Findings

During Stage 2, SoCalGas and SDG&E analyzed the data to determine whether the line would be replaced or hydrotested.

- On the basis of Stage 1 review, L-2000 West was divided into five sections, Whittier-1, Santa Fe Springs-2, Pico Rivera-3, Commerce-4 and the Santa Fe Springs Station Redesign.
- Suitable endpoint locations were chosen to accommodate test head piping installation, water storage tanks and equipment, water discharge, and to minimize disruption to the community.
- A TVR, and a decision tree analysis of each of the sections of L-2000 West was completed and each section was confirmed as a hydrotest because the sections were greater than 1,000 feet, had manageable customer impacts and had no engineering factors supporting replacement (as discussed below, the Santa Fe Springs Station Redesign was less than a 1,000 feet, but was re-scoped as a separate project and will be submitted in a future reasonableness review application).

Whittier – 1

Engineering Factors

The furthest east test section, Whittier - 1, was 4.182 miles in length from Lambert Rd. and Scott Ave. to SoCalGas Santa Fe Springs Station. This test includes 417 feet of Category 4 Criteria and 4.102 accelerated miles. The test mileage was laid out to include multiple non-contiguous Category 4 segments in one hydrotest as a cost savings measure to save construction time in the field, reduce mobilization and demobilization costs, minimize impacts to the community and accelerate Phase 2 pipe.

Pipeline Safety Enhancement Plan Workpaper Supporting Chapter III

LINE 2000 WEST HYDROTEST PROJECT

Santa Fe Springs – 2

Engineering Factors

The second test section, Santa Fe Springs – 2 is 1.635 miles in length from SoCalGas Santa Fe Springs Station to the Union Pacific Railroad ROW near the intersection of Pioneer Blvd. and Los Nietos Rd. This test includes 1.306 Category 4 Criteria miles and 0.329 incidental miles. Through the installation of a stopple fitting and a bypass, a peaker plant served by this line was planned to be provided with uninterrupted service.

Pico Rivera – 3

Engineering Factors

The middle test section, Pico Rivera – 3 is 3.671 miles in length from SoCalGas Santa Fe Springs Station to the Home Depot parking lot at the intersection of Telegraph Rd. and S Garfield Ave. This test includes 3.176 Category 4 Criteria miles and 0.495 incidental miles.

Commerce – 4

Engineering Factors

The furthest west test section, Commerce – 4 is 4.778 miles in length from the Home Depot parking lot at the intersection of Telegraph Rd. and S Garfield Ave to the intersection of Spence St. and 14th St. This test includes 4.214 Category 4 Criteria miles and 0.564 incidental miles.

Santa Fe Springs Station Redesign

Engineering Factors

The Santa Fe Springs Station Redesign project includes 511.4 feet of Category 4 Criteria pipe that connects to a gas filtration scrubber system within the Santa Fe Springs Station that was identified as a hydrotest. Due to the complexity of the design, this portion of the project was

Pipeline Safety Enhancement Plan Workpaper Supporting Chapter III
LINE 2000 WEST HYDROTEST PROJECT

later re-scoped as a separate project and will be submitted in a future reasonableness review application.

Pipeline Safety Enhancement Plan Workpaper Supporting Chapter III

LINE 2000 WEST HYDROTEST PROJECT

Stage 3 – Initial Planning and Design

During Stage 3, SoCalGas and SDG&E developed a Phase 2 WOA estimate, and began field surveys to complete preliminary design drawings and further refine scope.

In addition to the schedule and estimate, other key activities include identifying all permits, TRE's, and easements, defining long lead materials and pricing, understanding customer impacts and interruptions, and preparing any necessary environmental submittals.

Planning and Design Activity

Each section was extended to the nearest suitable endpoint location to accommodate test head piping installation, water storage tanks and equipment, water discharge, and to minimize disruption to the neighborhood

In addition, outage coordination with the peaker plant allowed the Santa Fe Springs - 2 and Pico Rivera - 3 sections to be combined into one hydrotest rather than two separate hydrotests. This change minimized customer impact and decreased project cost by reducing the number of hydrotests and the need for a stopple fitting and bypass.

The name of the combined section was changed to Pico Rivera - 2. This also caused the "Commerce 4" section to be changed to "Commerce 3".

Additional Considerations

- Planning and engineering design activities were expedited and coordinated with the peaker plant planned maintenance outage.
- Coordinated the completion of work with Home Depot, as they required that PSEP vacate the site before the holiday season. PSEP was using this location as an active construction site and for the placement of water storage/baker tanks.
- Verify tap statuses in a timely manner.
- Excavate and remove approximately twenty drip legs and several hump bands.

Pipeline Safety Enhancement Plan Workpaper Supporting Chapter III

LINE 2000 WEST HYDROTEST PROJECT

Cost Avoidance

- The hydrotests require approximately 3 million gallons for the entire project assuming disposal after each test. In an effort to minimize the water consumption, the plan was designed to reuse the water after each test. Water was stored in water storage tanks located at two specific test ends and was trucked from one location to the next. Once the hydrotests were completed, the water was treated and donated to a local golf course.
- For the Whittier-1 segment hydrotest, a lake tank was installed (see Figure 9). One lake-tank is the equivalent of 30 water storage tanks and takes up significantly less square footage.
- This project utilized one work site for multiple hydrotests, water storage and re-use of the test water for the hydrotests.

Estimate of Costs

SoCalGas and SDG&E estimated the total loaded costs for the five sections to be \$23,758,708, as shown in Table 3. This estimate was prepared using Stage 3 SCG Pipeline Estimate Template Rev 0 estimating tool. This estimate was completed late in Stage 3 and design plans reflect actual professional services estimates received and actual costs information from Line 2000A project. Please note: this estimate included the Santa Fe Springs Station Redesign Project (\$885,000 in direct costs) that was later removed in Stage 4.

Pipeline Safety Enhancement Plan Workpaper Supporting Chapter III
LINE 2000 WEST HYDROTEST PROJECT

Table 3: L-2000 W Phase 2 WOA Estimate

Cost Category	Phase 2 WOA
Company Labor Costs	\$ 1,179,279
Contract Costs	\$ 16,319,334
Material Costs	\$ 1,844,787
Other Direct Costs	\$ 2,321,061
Total Direct Costs	\$ 21,664,461
Total Indirect Costs	\$ 2,094,247
Total Loaded Costs	\$ 23,758,708

Pipeline Safety Enhancement Plan Workpaper Supporting Chapter III

LINE 2000 WEST HYDROTEST PROJECT

Stage 4 – Detailed Engineering Design and Procurement

During Stage 4, detailed design and material procurement was completed in order to provide a construction ready packet to the construction contractor to execute the planned project scope. The following scope changes occurred during this stage:

Detailed Planning and Design

- Additional scope validation reclassified 0.32 miles of Category 4 mileage to Category 1 reducing criteria mileage and increasing incidental mileage for Commerce-3.
- Due to the complexity of the design, the Santa Fe Springs Station gas filtration scrubber system redesign project was re-scoped. This redesign, which will bring the station up to current standards, required additional time for planning and design, so the project schedule was deferred.

Additional Considerations

- Outage coordination of hydrotest with the peaker plant scheduled maintenance outage.
- Performed planning and engineering design activities to accommodate the peaker plant outage and timing for Home Depot parking lot time restrictions.

Construction Contractor Selection

Construction of L-2000 West Project started after the PSEP Performance Partnership Program was established; therefore, the construction contract was awarded to a Performance Partner for this geographical area.

The Performance Partner/Construction Contractor TPE for Section 1, 2 and 3 was \$ [REDACTED] which is \$ [REDACTED] more than the Stage 3 construction contractor direct estimate of \$ [REDACTED] that was used to develop the Phase 2 WOA estimate.

Pipeline Safety Enhancement Plan Workpaper Supporting Chapter III
LINE 2000 WEST HYDROTEST PROJECT

Stage 5 – Construction

Schedule

Construction Start: 07/21/2014

NOP Date: 12/18/2014

Construction Finish: 01/30/2015

Field Conditions

Conditions were encountered in the field that were not anticipated during design and planning that had to be addressed or mitigated. These conditions impacted the project scope and schedule. Listed below is a summary of the key field changes broken down by type of change for each project section:

Whittier 1

Safety:

- Use of a Lake tank (see Figure 9) required the addition of 24 hour security and the addition of light towers.

Test Preparation:

- Additional excavation was required to replace a wrinkle bend, increasing the length of construction.
- Addition of a Pressure Control fitting to provide continued service.
- Headwall had to be replaced when it was damaged during removal of the wrinkle bend.

Gas Handling:

- Isolation of a supply line required installation of a pressure control fitting and expanded excavation to minimize customer impacts and supply line gas blow off.

Pipeline Safety Enhancement Plan Workpaper Supporting Chapter III
LINE 2000 WEST HYDROTEST PROJECT

Weather:

- Inclement weather caused two construction stoppages for safety reasons.

Integrity Inspections:

- Engineering integrity assessments required that the bell hole be expanded .

Pico Rivera 2

Customer Impacts:

- To meet the Peaker Plant outage dates the construction schedule had to be accelerated. This required expanded working hours, as well as the removal of the Santa Fe Springs Station Redesign scope which modified installation plans.

Substructures:

- SoCalGas potholed to identify existing substructures. Although best practices were followed, not all substructures were identified. To remediate the congestion of the underground substructures, project scope was expanded and installation plans were redesigned.

Safety:

- Railroad ROW required the hiring of flagging services for contractor safety.

Expanded Excavation:

- Multiple tap locations required expanded excavations to locate taps.

Pipeline Safety Enhancement Plan Workpaper Supporting Chapter III

LINE 2000 WEST HYDROTEST PROJECT

Commerce 3

Schedule/TRE Agreement:

- A schedule acceleration was required to meet TRE agreement with Home Depot parking lot requirements to demobilize from the lot by the end of October. The acceleration required expanded working hours, including night work.

Expanded Excavation:

- Multiple pipeline features required further excavation to locate for planned work.

Design Modifications

- Modifications to multiple supply line isolation plans were required for design constructability and minimization of customer impacts. These modifications required increased depth of excavation (including the removal of a vault), and the additional installation of a pressure control fitting.

Substructures:

- SoCalGas potholed to identify existing substructures. Although best practices were followed, not all substructures were identified. To remediate the congestion of the underground substructures, project scope was expanded and installation plans were redesigned.

Pipeline Safety Enhancement Plan Workpaper Supporting Chapter III
LINE 2000 WEST HYDROTEST PROJECT

Figure 9: Lake Tank used for storing hydrotest water



Pipeline Safety Enhancement Plan Workpaper Supporting Chapter III
LINE 2000 WEST HYDROTEST PROJECT

Stages 6 and 7 – Commissioning and Closeout

Commissioning activities included site restoration, final inspections, and placement of the pipeline back into service, transportation and disposal of the hydrotested water or hazardous material and demobilization from the site. Close out activities included development of final drawings, the reconciliation package and updates to company systems to reflect the changes made to the system.

Cost Variance

Table 4: L-2000W Phase 2 WOA and Actual Costs

COST SUMMARY				
	PHASE 2 WOA	O&M (actuals)	CAPITAL (actuals)	DELTA over/(under)
COMPANY LABOR	\$ 1,179,279	\$ 467,594	\$ 362,603	\$ (349,082)
CONTRACT COSTS	\$ 16,319,334	\$ 11,491,651	\$ 1,658,712	\$ (3,168,970)
MATERIALS	\$ 1,844,787	\$ 491,400	\$ 210,453	\$ (1,142,934)
OTHER DIRECTS	\$ 2,321,061	\$ 3,119,036	\$ 5,407,075	\$ 6,205,051
INDIRECTS	\$ 2,094,247	\$ 833,384	\$ 796,923	\$ (463,941)
TOTAL LOADED	\$ 23,758,708	\$ 16,403,065	\$ 8,435,767	\$ 1,080,124

Table 4 compares the Phase 2 WOA estimate and the March 2016 total loaded actual costs. The total loaded costs incurred is \$24,838,832 for O&M and capital which is \$1,080,124 more than the Phase 2 WOA estimate. This project includes \$8,435,767 capital for six tie-in pieces and twenty replacement sections to cut out twelve drips/drains, four taps, three hump bands and one wrinkle bend; the 46 segments totaled 423 feet of pipe. However because the Santa Fe Springs Station project, which was estimated to cost \$885,000 (direct), was removed from scope, the variance for the remaining four hydrotests is approximately \$1,965,000.

The above variance is largely attributable to underestimation of the actual construction contractor costs, which as described in Stage 4 was \$2,506,738 more than the estimated costs. In addition, scope changes and unanticipated conditions that occurred after the Phase 2 WOA estimate increased costs (including: additional security; scope changes to replace a wrinkle bend, engage in additional inspections, and perform additional excavations to identify taps and features; and expanded work hours to meet a noncore customers outage dates and comply with a TRE agreement) and an early cost estimating tool and process resulted in underestimation of

Pipeline Safety Enhancement Plan Workpaper Supporting Chapter III
LINE 2000 WEST HYDROTEST PROJECT

construction contractor costs and overestimation of other costs such as materials. These increased costs were reasonably incurred to complete the project, but were not accounted for in the Stage 3 estimate.

Disallowances

For this hydrotest project, SoCalGas and SDG&E has identified a total of 324 feet of pipe as being installed post 1955 and lacking pressure test records that provide the minimum information to demonstrate compliance with industry standards or regulatory strength testing and recordkeeping requirements then applicable. Of the 14.571 miles of pipeline that was pressure tested, 321 feet (.42%) of Phase 1A pipe is disallowed, therefore \$68,470 (.42%) of total project O&M costs are disallowed from recovery. Of the pipeline that was replaced, 3 feet of incidental pipe was disallowed. Therefore an \$1,020 reduction was made to ratebase calculated by determining the replacement mileage and multiplying the amount by \$1.7 million per mile, which is SoCalGas' and SDG&E's system average cost of pressure testing.

Pipeline Safety Enhancement Plan Workpaper Supporting Chapter III

LINE 2000 WEST HYDROTEST PROJECT

Conclusion

SoCalGas and SDG&E enhanced the safety of their natural gas system by prudently executing the Line 2000 West Hydrotest Project. Through this hydrotest project, SoCalGas and SDG&E successfully pressure tested 14.554 miles of pipe of varying diameters Santa Fe Springs/Whittier/Pico Rivera area. The project incurred a total loaded project cost of \$24,838,832.

SoCalGas and SDG&E executed this project prudently: engaging in prudent cost avoidance efforts; minimizing customer impacts; minimizing community impacts; including incidental and accelerated footage to enhance constructability and efficiency; coordinating work to share worksites and reuse water; donating treated water to a local golf course; and responding to schedule requirements, unknown field conditions, and scope changes.

SoCalGas and SDG&E's total loaded project cost of \$24,838,832 is reasonable and should be approved (minus acknowledged disallowances). SoCalGas and SDG&E engaged in prudent cost avoidance efforts (reducing project scope through scope validation; sharing worksites between hydrotest sections to realize efficiencies; using a lake tank instead of water storage tanks; reusing water across hydrotests; and combining two hydrotests to reduce costs and realize efficiencies); engaged in reasonable efforts to promote competitive and market-based rates for contractor services and materials (see Chapter II (Phillips) (approximately 98% of PSEP agreements with contractors and suppliers were either competitively bid or through agreements entered into using market-based rates based on a recent competitive sourcing event)); and used a reasonable amount of company and contractor resources given the project's complexity (a multiple section hydrotest across populated areas of multiple cities) and work scope changes (see above).

End of Line 2000 West Workpaper

Pipeline Safety Enhancement Plan Workpaper Supporting Chapter III
LINE 2001 WEST A REPLACEMENT PROJECT

Summary

Table 1: Summary of L-2001 West A (Sections 15 and 16) Replacement Project

Project Name	L-2001 West A (Sections 15 and 16) Replacement Project
WOA Number / Date	91101 / August 5, 2014
City	Industry
Predominate Pipe Vintage	1950
Original Pipe Diameter/New Diameter	██████████
Construction Start / Finish	April 28, 2014 / May 27, 2014
Loaded Capital Costs	\$822,206
Loaded O&M Costs	\$ 0
Total Loaded Project Costs	\$822,206
Disallowance	\$ 0

Background

L-2001 West is approximately 146 miles in length extending from the City of Banning, California to the City of La Puente, California. In the 2011 PSEP filing,¹ it was identified as having 64.1 miles of Category 4 piping in Criteria areas to be further evaluated for hydrostatic testing or replacement. L- 2001 West was separated into Projects L-2001 West A (Sections 15 and 16), L-2001 West B (Sections 10, 11, 14, 17, 18 and 19) and L-2001 West C (Sections 1 through 9).

This workpaper addresses the L-2001 West A (Sections 15 and 16) Replacement Project. The L-2001 West A (Sections 15 and 16) Replacement Project was completed in conjunction with a scheduled shut-in with a SoCalGas Pipeline Integrity project and coordinated work during the same shut-in. L-2001 West B (Sections 10, 11 and 14) is described in a separate workpaper in this application. The remaining sections of L-2001 West B (Section 17, 18 and 19) and L-2001 West C (Sections 1 through 9) will be submitted in a future reasonableness review filing.

¹ See December 2, 2011 Amended Pipeline Safety Enhancement Plan (PSEP) of SoCalGas and SDG&E.

Pipeline Safety Enhancement Plan Workpaper Supporting Chapter III
LINE 2001 WEST A REPLACEMENT PROJECT

Description

Through the L-2001 West A (Sections 15 and 16) Replacement Project, SoCalGas and SDG&E enhanced its high-pressure transmission pipeline system by successfully replacing 31 feet of primarily [REDACTED] diameter pipe, as shown in Figures 1 and 2 and Table 2 which describe the project scope as submitted in the 2011 PSEP filing and the final mileage.

Examples of cost avoidance actions included:

- Scope validation for the entire L-2001 West pipeline resulted in a decrease of mileage from 64.100 miles to 18.801 miles.
- The 2001 West A (Sections 15 and 16) Replacement Project coordinated with a nearby SoCalGas Pipeline Integrity project to minimize customer impact by having one shut-in and one mobilization and demobilization.

Construction began in April 2014 and was completed in May 2014. The L-2001 West A (Sections 15 and 16) Replacement Project incurred a total loaded project cost of \$822,206.

Table 2: L-2001 West A Replacement Project - 2011 PSEP Filing and Final Mileage*

Line 2001 West A	Total Mileage	Criteria Mileage	Accelerated Mileage	Incidental Mileage
2011 PSEP Filing	64.100 mi.	15.809 mi.	48.291 mi.	0
Final Project Mileage				
Section 15	8 ft.	7 ft.	0	1 ft.
Section 16	23 ft.	8 ft.	0	14 ft.
Total	31 ft.	17 ft.	0	15 ft.

* Values may not add to total due to rounding.

Pipeline Safety Enhancement Plan Workpaper Supporting Chapter III
LINE 2001 WEST A REPLACEMENT PROJECT

Figure 1: Overview Map of L-2001 West A (Sections 15 and 16) Replacement Project



Figure 2: Overview Image of L-2001 West A (Sections 15 and 16) Replacement Project



Pipeline Safety Enhancement Plan Workpaper Supporting Chapter III
LINE 2001 WEST A REPLACEMENT PROJECT

Stage 1 – Project Initiation

In workpapers supporting the 2011 PSEP filing, SoCalGas and SDG&E identified L-2001 West as a Phase 1A replacement/hydrotest project. It comprised approximately 15.809 miles of Criteria and 48.291 of accelerated miles of primarily [REDACTED] diameter high-pressure pipe. L-2001 West was first installed between 1948 and 1953.

Upon completion of scope validation, the hydrotest records supported a scope reduction of Category 4 Criteria mileage from 15.809 miles to 4.637 miles and reduced the accelerated mileage from 48.291 miles to 14.164 miles.

Pipeline Safety Enhancement Plan Workpaper Supporting Chapter III
LINE 2001 WEST A REPLACEMENT PROJECT

Stage 2 – Analysis and Findings

During Stage 2, data analysis was performed and the findings were used to define project scope and to plan tasks for later stages of the project.

For project efficiencies, the L-2001 West PSEP Project was split into 5 smaller projects: A, B, C, D and E. L-2001 West A consisted of Sections 15 and 16. The team gathered information from Pipeline Integrity regarding pipeline work being conducted adjacent to Sections 15 and 16 of L-2001 West A and determined that these sections could be replaced along with the separate Pipeline Integrity work. This would allow the PSEP project to take advantage of the shut-in that Pipeline Integrity had already scheduled; realizing cost savings by minimizing the contractor cost due to one mobilization and reducing customer impact.

Engineering Factors

SoCalGas and SDG&E confirmed the scope of Section 15 to consist of approximately 8 feet of [REDACTED] diameter pipe and Section 16 to consist of approximately 9 feet of [REDACTED] diameter pipe.

A PSEP Decision Tree analysis of Sections 15 and 16 confirmed that the project design should commence as a replacement project because the sections' scope was less than 1000 feet. The PSEP Decision Tree directs that scope less than 1000 feet should be replaced because, under most circumstances, replacements will be the cost effective option. In this instance, there were no conditions that justified overriding this guidance.

By coordinating PSEP work with a Pipeline Integrity project in the same vicinity, this PSEP project realized cost savings by minimizing the contractor cost due to one mobilization and reduced customer impact.

Pipeline Safety Enhancement Plan Workpaper Supporting Chapter III
LINE 2001 WEST A REPLACEMENT PROJECT

Stage 3 – Initial Planning and Design

During Stage 3, SoCalGas and SDG&E developed a Phase 2 WOA estimate and began field surveys to complete preliminary design drawings and further refine the scope.

In addition to the schedule and estimate, other key activities include identifying all permits, TREs, and easements, defining long lead materials and pricing, understanding customer impacts and interruptions, and preparing any necessary environmental submittals.

Planning and Design Activity

SoCalGas and SDG&E identified work space limitations due to adjacent railroad tracks, existing businesses, and a valve station. This limited work space required SoCalGas and SDG&E to closely coordinate resources and delivery of materials.

The initial engineering design for Section 15 consisted of replacement of approximately 8 feet of [REDACTED] diameter pipe. Section 16 consisted of replacement of approximately 9 feet of [REDACTED] diameter pipe. Both sections are on opposite ends of an existing valve station, which would require temporary modifications during construction in order for construction activities to occur.

Estimate of Costs

The work to replace these sections was coordinated with another project managed by Pipeline Integrity to take advantage on the pipeline being blown down the project was moved ahead of other 2001 West projects and thus did not formally complete all the stage gate activities. The project was expedited and utilized the existing Phase 1 WOA to begin project activities and construction. A Phase 2 WOA was later developed for the replacement of these sections and utilized the TVR cost estimate that was developed in Stage 2.

The estimated total loaded cost for L-2001 West A (Sections 15 and 16) was \$773,605 and was based on preliminary designs. This estimate was prepared in December 2013 using the TVR Cost Estimate Tool Rev 1.

Pipeline Safety Enhancement Plan Workpaper Supporting Chapter III
LINE 2001 WEST A REPLACEMENT PROJECT

Table 3: L-2001 West A (Sections 15 and 16) Replacement Project Phase 2 WOA Estimate

Cost Category	Phase 2 WOA Estimate
Company Labor Costs	\$47,000
Contract Costs	\$650,000
Material Costs	\$400
Other Direct Costs	\$2,600
Total Direct Costs	\$700,000
Total Indirect Costs	\$73,605
Total Loaded Costs	\$773,605

Pipeline Safety Enhancement Plan Workpaper Supporting Chapter III
LINE 2001 WEST A REPLACEMENT PROJECT

Stage 4 – Detailed Engineering Design and Procurement

During Stage 4, detailed design and material procurement was completed in order to provide a construction ready packet to the construction contractor to execute the planned project scope.

In addition, during this stage SoCalGas and SDG&E determined that construction on Sections 15 and 16 should be completed simultaneously in order to take advantage of one mobilization and minimize impacts to the local businesses and the adjacent railroad traffic.

Detailed Planning and Design

There were no scope changes from Stage 3 to Stage 4.

Construction Contractor Selection

The project was sourced to the same construction contractor that had competitively bid for the adjacent Pipeline Integrity project. The following was considered prior to proceeding:

- Use of the same contractor allowed SoCalGas and SDG&E to limit to one mobilization and demobilization.
- Plan for one shut-in for the pipeline.

The Construction Contractor fixed price was \$ [REDACTED] which is \$ [REDACTED] more than the Stage 2 construction contractor direct estimate of \$ [REDACTED].²

² This construction contractor estimate was based on the Stage 2 TVR analysis.

Pipeline Safety Enhancement Plan Workpaper Supporting Chapter III
LINE 2001 WEST A REPLACEMENT PROJECT

Stage 5 – Construction

Schedule

Construction Start Date: 04/28/2014

NOP Date: 05/22/2014

Construction Finish Date: 05/27/2014

The construction was planned for 9.5 weeks, but took 12 weeks due to the reasons discussed below.

Field Conditions

Conditions were encountered in the field that were not anticipated during design and planning that had to be addressed or mitigated. Listed below is a summary of the key field changes broken down by type of change for this project:

Environmental:

- Coal tar wrap was discovered in the trenches during excavation. The coal tar wrap was assumed to be on the pipe and was not anticipated to be in the surrounding soil. This delayed the project by three and half weeks because of the need for environmental cleanup.

Field Design Change:

- The tie-in points were extended to remove wedding bands. The revised lengths for both sections are as follows:
 - Section 15 was extended by less than one foot.
 - Section 16 was extended to 23 feet.

Pipeline Safety Enhancement Plan Workpaper Supporting Chapter III
LINE 2001 WEST A REPLACEMENT PROJECT

Stages 6 and 7 – Commissioning and Closeout

Commissioning activities included site restoration, final inspections, and placement of the pipeline back into service, transportation and disposal of the hydrotested water or hazardous material and demobilization from the site. The valve station fencing and cathodic protection was put back into place. The temporary fencing was removed and laydown yard was restored. The permanent fencing owned by the adjacent business was replaced and the parking lot restored to pre-construction condition. Close out activities included development of final drawings, the reconciliation package and updates to company systems to reflect the changes made to the system.

Cost Variance

Table 4: L-2001 West A (Sections 15 and 16) Phase 2 WOA Estimate and Actual Costs

COST SUMMARY				
	PHASE 2 WOA	CAPITAL (actuals)	DELTA over/(under)	
COMPANY LABOR	\$ 47,000	\$ 63,654	\$	16,654
CONTRACT COSTS	\$ 650,000	\$ 229,211	\$	(420,789)
MATERIALS	\$ 400	\$ 11,830	\$	11,430
OTHER DIRECTS	\$ 2,600	\$ 440,126	\$	437,526
INDIRECTS	\$ 73,605	\$ 77,384	\$	3,779
TOTAL LOADED	\$ 773,605	\$ 822,206	\$	48,601

Table 4 compares the Phase 2 WOA estimate and the March 2016 loaded actual costs. The loaded actual cost exceeded the Phase 2 WOA estimate by \$48,601.

The above variance is attributable to scope changes and unanticipated conditions that occurred after the Phase 2 WOA estimate (including: identification of disbonded coal tar wrap and additional footage added to extend tie-in locations to include all Category 4 pipe) and an early cost estimating tool and process that was based on preliminary project designs (resulting in the underestimation of contractor costs, omission of some project costs, and costs unreflective of current market conditions). These increased costs were reasonably incurred to complete the replacement work, but were not accounted for in the Stage 3 estimate.

Pipeline Safety Enhancement Plan Workpaper Supporting Chapter III
LINE 2001 WEST A REPLACEMENT PROJECT

Disallowances

There was no disallowance for line L-2001 West A (Sections 15, 16) Replacement Project as there were no post-1955 segments included in the project without records that provide the minimum information to demonstrate compliance with industry standards or regulatory strength testing and recordkeeping requirements then applicable.

Pipeline Safety Enhancement Plan Workpaper Supporting Chapter III
LINE 2001 WEST A REPLACEMENT PROJECT

Conclusion

SoCalGas and SDG&E enhanced the safety of their natural gas system by prudently executing the L-2001 West A (Sections 15 and 16) Replacement Project. Through this replacement project, SoCalGas and SDG&E successfully replaced 31 feet of non-contiguous pipe of primarily [REDACTED] diameter in the City of Industry. The project incurred a total loaded project cost of \$822,206.

SoCalGas and SDG&E executed this project prudently: minimizing customer impacts; sectionalizing the Line 2001 work for project efficiencies; coordinating work with Pipeline Integrity; and executing the project successfully with a limited work space.

SoCalGas and SDG&E's total loaded project cost of \$822,206 is reasonable and should be approved. SoCalGas and SDG&E engaged in prudent cost avoidance efforts (decreasing project scope through record validation and coordinating work with Pipeline Integrity to realize cost savings and reduce customer impacts); engaged in reasonable efforts to promote competitive and market-based rates for contractor services and materials (see Chapter II (Phillips) (approximately 98% of PSEP agreements with contractors and suppliers were either competitively bid or through agreements entered into using market-based rates based on a recent competitive sourcing event)); and used a reasonable amount of company and contractor resources given the complex scope of work (work near railroad tracks, existing businesses, and a valve station) and work scope changes (identification of disbonded coal tar wrap and additional footage added to extend tie-in locations to include all Category 4 pipe).

End of L-2001 West A (Sections 15 and 16) Replacement Project

Pipeline Safety Enhancement Program Workpaper Supporting Chapter III
LINE 2001 WEST B REPLACEMENT AND HYDROTEST PROJECT

Summary

Table 1: Summary of L-2001 West-B Sections 10, 11 & 14 Project

Project Name	L-2001 West B Sections 10, 11 & 14 Replacement and Hydrotest Project
WOA Number / Date	
Section 10 - Hydrotest	91089 & 25343 / July 9, 2014
Section 11 - Hydrotest	91089, 25343 / July 9, 2014
Section 14 - Replacement	91089, 25343 / July 9, 2014
Cities	Banning, Chino Hills and Beaumont
Original Pipe Diameter/New Diameter	██████████
Construction Start / Finish	
Section 10 - Hydrotest	August 18, 2014 / February 27, 2015
Section 11 - Hydrotest	October 27, 2014 / April 30, 2015
Section 14 - Replacement	October 13, 2014 / February 13, 2015
Loaded Capital Costs	\$ 4,552,781
Loaded O&M Costs	\$ 8,472,490
Total Loaded Project Costs	\$13,025,271
Disallowance	\$ 0

Background

L-2001 West is a high pressure transmission line that is approximately 146 miles long, beginning east of Indio running west through the cities of Moreno Valley, Riverside, Industry and Chino Hills, ending in the City of Rosemead. L- 2001 West was separated into Projects L-2001 West A (Sections 15 and 16), L- 2001 West B (Sections 10, 11, 14, 17, 18 and 19) and L-2001 West C (Sections 1 through 9).

This workpaper addresses the L-2001 West B (Sections 10, 11 and 14) Replacement Project. For constructability purposes, L-2001 West B Project was separated into six sections (10, 11, 14, 17, 18 and 19). During Stage 5, Sections 17, 18 and 19 were re-scoped and will be submitted for reasonableness review in a future filing.

Pipeline Safety Enhancement Program Workpaper Supporting Chapter III
LINE 2001 WEST B REPLACEMENT AND HYDROTEST PROJECT

PSEP work on Section 10 was coordinated with an operating district project and the PSEP Valve ~~Team-project~~ that was immediately adjacent to this PSEP project. As part of the Banning Valve Bundle Project, a new MLV was identified as necessary to meet the isolation objectives of the PSEP Valve Enhancement Plan.¹ Separate cost accounts were established for the PSEP pipeline work, PSEP valve automation work, and operating district work. This workpaper addresses the PSEP pipeline-related work only.

Description

Through the L-2001 West B Sections 10, 11 & 14 Replacement and Hydrotest Project, SoCalGas and SDG&E enhanced its high-pressure transmission pipeline system by successfully replacing 24 feet and hydrotesting 2.9348 miles of primarily [REDACTED] diameter pipe, as shown in Figures 1 to 6 and Table 2 that describes the project scope as of the 2011 PSEP filing and the final construction scope.

Examples of cost avoidance actions included:

- Total scope reduction of 45.3 miles for the entire L-2001 W through scope validation.
- Section 10 was coordinated with the operating district to avoid two separate contractor mobilizations, two blow downs and two system capacity reductions.
- Section 10 was coordinated with PSEP valve team for installation of a new MLV to avoid two separate contractor mobilizations, two blow downs and two system capacity reductions.

Construction began on L-2001 West B sections in August 2014 and was completed in April 2015. The project incurred a total loaded project cost of \$13,025,271.

¹ The installation and automation of this valve (MLV 2001-~~193.31-0~~ 139.76-0) is part of the Banning Valve Bundle and will be submitted in a future reasonableness review application.

Pipeline Safety Enhancement Program Workpaper Supporting Chapter III
LINE 2001 WEST B REPLACEMENT AND HYDROTEST PROJECT

Table 2: L-2001 West B Hydrotest and Replacement Project - 2011 PSEP Filing and Final Mileage*

Line 2001 West	Total Mileage	Criteria Mileage	Accelerated Mileage**	Incidental Mileage
2011 PSEP Filing: Sections 1-19	64.100 mi.	15.809 mi.	48.29 mi.	0
L-2001 West B				
Section 10 - Hydrotest	2.029 mi.	2.029 mi.	0	0
Section 11 - Hydrotest	4,783 ft.	0.7514 mi. 3,967 ft.	0	816 ft.
Section 14 - Replacement	24 ft.	2 ft.	15 ft.	7 ft.
Total	2.939 mi.	2.7806 mi.	15 ft.	823 ft.

*Values may not add to total due to rounding.

**Accelerated mileage includes Phase 1B and Phase 2 pipe. Phase 2 includes pipelines without sufficient record of a pressure test in less populated areas (Phase 2A) or pipelines with record of a pressure test, but without record of a pressure test to modern – Subpart J – standards (Phase 2B). Included in this project was 15 feet of pipe accelerated from SoCalGas and SDG&E’s PSEP Phase 2B. This Phase 2B footage was included to realize efficiencies and to enhance project constructability.

Pipeline Safety Enhancement Program Workpaper Supporting Chapter III
LINE 2001 WEST B REPLACEMENT AND HYDROTEST PROJECT

Figure 1: Overview map of L-2001 West B Sections 10, 11 & 14

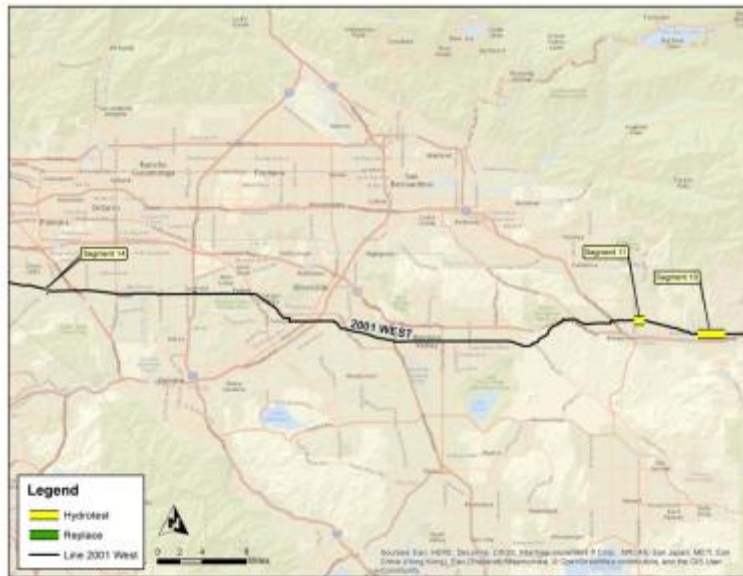


Figure 2: Satellite Image of L-2001 West B Sections 10, 11 & 14



Pipeline Safety Enhancement Program Workpaper Supporting Chapter III
LINE 2001 WEST B REPLACEMENT AND HYDROTEST PROJECT

Figure 5: Overview map of L-2001 West-B Section 11 Hydrotest Project (Revised)



Figure 6: Satellite Image of L-2001 West-B Section 11 Hydrotest Project



Pipeline Safety Enhancement Program Workpaper Supporting Chapter III

LINE 2001 WEST B REPLACEMENT AND HYDROTEST PROJECT

Figure 7: Overview map of L-2001 West-B Section 14 Replacement Project

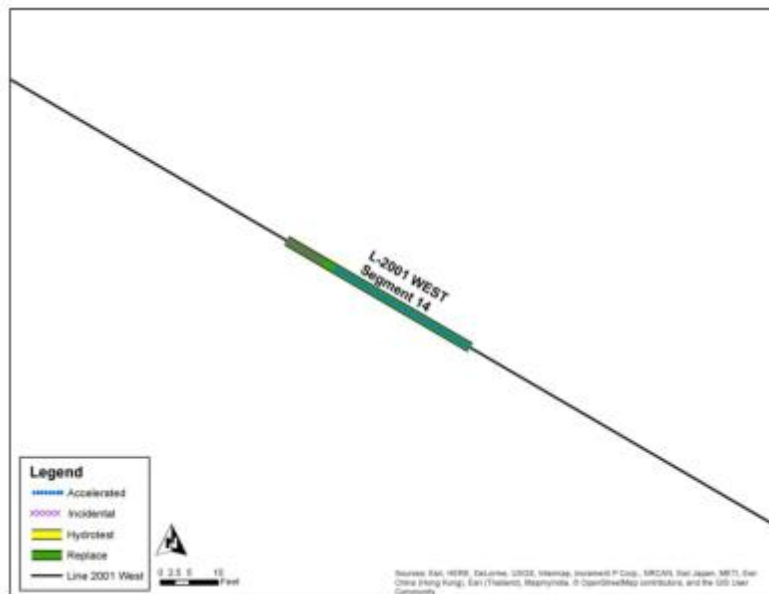


Figure 8: Satellite Image of L-2001 West-B Section 14 Replacement Project



Pipeline Safety Enhancement Program Workpaper Supporting Chapter III
LINE 2001 WEST B REPLACEMENT AND HYDROTEST PROJECT

Stage 1 – Project Initiation

In workpapers supporting the 2011 PSEP filing,² SoCalGas and SDG&E identified L-2001 West as a Phase 1A hydrotest project. The scope on the original PSEP filing with the CPUC included 64 miles of primarily [REDACTED] high-pressure pipe, of which approximately 15.81 miles were Category 4 Criteria mileage. L-2001 West was first installed between 1948 and 1953.

Upon completion of scope validation, the hydrotest records supported a scope reduction of Category 4 Criteria mileage from 15.81 miles to 4.63 miles. The 4.63 miles includes the scope of work for all sections of L-2001.

² See December 2, 2011 Amended Pipeline Safety Enhancement Plan (PSEP) of SoCalGas and SDG&E.

Pipeline Safety Enhancement Program Workpaper Supporting Chapter III
LINE 2001 WEST B REPLACEMENT AND HYDROTEST PROJECT

Stage 2 – Analysis and Findings

During Stage 2, data analysis was performed and the findings were used to define project scope and to plan tasks for later stages of the project.

As a result of this analysis, SoCalGas and SDG&E determined the following:

- Section 10 – Hydrotest
- Section 11 – Hydrotest
- Section 14 – Replace
- Section 17 – Replace
- Section 18 – Replace
- Section 19 – Replace

Engineering Factors

For the sections presented in this application and the subject of this workpaper (10, 11 & 14), the following was determined:

- A PSEP Decision Tree analysis of Section 14 confirmed that the project design should commence as a replacement project because the section scope was less than 1,000 feet. The PSEP Decision Tree directs that scope less than 1,000 feet should be replaced because under most circumstances, it is the cost effective option. In this instance there were no conditions that justified overriding this guidance.
- Sections 10 and 11 were identified as hydrotests because they were greater than 1,000 feet, had manageable customer impacts and had no engineering factors supporting replacement.

Pipeline Safety Enhancement Program Workpaper Supporting Chapter III
LINE 2001 WEST B REPLACEMENT AND HYDROTEST PROJECT

Stage 3 – Initial Planning and Design

During Stage 3, SoCalGas and SDG&E developed a Phase 2 WOA estimate, began field surveys to complete preliminary design drawings and refined the scope.

In addition to the schedule and estimate, other key activities include identifying all permits, TRE's, and easements, defining long lead materials and pricing, understanding customer impacts and interruptions, and preparing any necessary environmental submittals.

Planning and Design Activity

Section 10 – Hydrotest 2.029 mi of pipe.

Section 11 – Hydrotest 0.906 mi of pipe.

Section 14 – Replace in place 23 feet of pipe. (An additional 21 feet of pipe was planned to accommodate the final tie-in locations).

Section 17 – Replace 220 feet of pipe by jack and bore.

Section 18/19 – Replace in place 16 feet of pipe

Additional Considerations

Section 10 would be coordinated with an adjacent operating district project in order to achieve cost savings by utilizing one contractor that was competitively bid as part of the performance partnership program.

Cost Avoidance

A new MLV was planned and installed by the PSEP valve team. By synchronizing the schedules, the number of mobilizations and blow downs could be minimized along with potential customer impact.

Pipeline Safety Enhancement Program Workpaper Supporting Chapter III
LINE 2001 WEST B REPLACEMENT AND HYDROTEST PROJECT

Estimate of Cost

The estimated total loaded costs for L-2001 West B (Sections 10, 11, 14, 17, and 18/19) was \$12,464,474, and is based on preliminary designs (see Table 3). The total estimated cost includes hydrotesting sections 10 and 11 and replacing sections 14, 17, 18/19. This estimate was prepared in July 9, 2014 using the Stage 3 SCG Pipeline Estimate Template Rev 0 estimating tool.

Table 3: L-2001 West B Phase 2 WOA Estimate

Cost Category	Phase 2 WOA
Company Labor Costs	\$ 953,466
Contract Costs	\$ 4,549,029
Material Costs	\$ 500,397
Other Direct Costs	\$ 4,575,754
Total Direct Costs	\$10,578,646
Total Indirect Costs	\$ 1,885,828
Total Loaded Costs	\$12,464,474³

The direct cost estimates broken out for Sections 10, 11, and 14 are shown below.

Table 4: L-2001 West B Stage 3 Direct Cost Estimate

Cost Category	Section 10	Section 11	Section 14	Stage 3 Estimate- 10,11,14
Company Labor Costs	\$281,291	\$234,429	\$76,846	\$592,566
Contract Costs	\$1,330,234	\$974,806	\$284,878	\$2,589,918
Material Costs	\$121,343	\$121,900	\$36,187	\$279,430
Other Direct Costs	\$1,421,830	\$1,141,997	\$443,297	\$3,007,124

³ The Phase 2 WOA estimate reflects \$4,109,608 of direct cost for segments 17 and 18/19.

Pipeline Safety Enhancement Program Workpaper Supporting Chapter III
LINE 2001 WEST B REPLACEMENT AND HYDROTEST PROJECT

Total Direct Costs	\$3,154,697	\$2,473,132	\$841,209	\$6,469,038
Total Indirect Costs	N/A	N/A	N/A	N/A
Total Loaded Costs	N/A	N/A	N/A	N/A

Pipeline Safety Enhancement Program Workpaper Supporting Chapter III
LINE 2001 WEST B REPLACEMENT AND HYDROTEST PROJECT

Stage 4 – Detailed Engineering Design and Procurement

During Stage 4, detailed design and material procurement was completed in order to provide a construction ready packet to the construction contractor to execute the planned project scope. While planning and design activities occurred for Sections 17, 18 and 19, because they were subsequently re-scoped, details regarding the planning, design, and construction have been omitted from the remainder of this workpaper. These sections will be filled in a future Reasonableness Review application. The scope changes that occurred during this stage are detailed below.

Detailed Planning and Design

Section 10

- The City of Banning planned a future roadway on the existing pipeline easement requiring the valve to be placed underground in a vault (see figure [97](#)) with traffic rated lids. This created extensive redesign which impacted the construction schedule. Vault cover was determined to be a long-lead item.

Section 11

- The planned tie-in location on the east end had to be moved because of an obstruction with the storm drain; because the storm drain was not where the as-built showed it to be which caused an obstruction and caused the tie-in location to be moved.
- Land rights for the planned west end laydown yard could not be secured. The city provided access for our Baker tanks and associated construction equipment in the street, which resulted in the reduction of working hours to accommodate a bike race and a holiday moratorium.
- The west east tie-in location was moved in order to not be in an intersection.
- Engineering review showed the need to provide service to a regulator station that was fed off of line 2001. A near-by supply line was tapped to provide a permanent feed into the existing regulator station.

Pipeline Safety Enhancement Program Workpaper Supporting Chapter III
LINE 2001 WEST B REPLACEMENT AND HYDROTEST PROJECT

Section 14

- No scope change from Stage 3 to Stage 4.

Pipeline Safety Enhancement Program Workpaper Supporting Chapter III
LINE 2001 WEST B REPLACEMENT AND HYDROTEST PROJECT

Construction Contractor Selection

Construction of L-2001 West B project was managed by the PSEP Performance Partnership.

The Performance Partner/Construction Contractor TPE for Section 10 was \$ [REDACTED], which was \$ [REDACTED] less than the Stage 3 construction contractor direct estimate of \$ [REDACTED] that was used to develop the Phase 2 WOA estimate.

The Performance Partner/Construction Contractor TPE for Section 11 was \$ [REDACTED] which was \$ [REDACTED] more than the Stage 3 construction contractor direct estimate of \$ [REDACTED] that was used to develop the Phase 2 WOA estimate.

The Performance Partner/Construction Contractor TPE for Section 14 was \$ [REDACTED], which was \$ [REDACTED] less than the Stage 3 estimate of construction contractor direct estimate of \$ [REDACTED] that was used to develop the Phase 2 WOA estimate.

Pipeline Safety Enhancement Program Workpaper Supporting Chapter III
LINE 2001 WEST B REPLACEMENT AND HYDROTEST PROJECT

Stage 5 – Construction

Schedule

Section 10

Construction Start Date: 08/18/2014

NOP Date: 11/12/2014

Construction Finish Date: 02/27/2015

The hydrotest of Section 10 was executed with 2.0288 miles of pipe that parallels Wilson Street in the City of Banning. The construction lasted 28 weeks from mobilization to demobilization instead of the planned 9 weeks. The 2001 W B Section 10 MLV installation and shoring work is shown in Figure [97](#).

Section 11

Construction Start Date: 10/27/2014

NOP Date: 03/27/2015

Construction Finish Date: 04/30/2015

The hydrotest of Section 11 was executed with 0.906 miles of pipe in the City of Beaumont. The construction lasted 26 weeks from mobilization to demobilization instead of the planned 9 weeks.

Section 14

Construction Start Date: 10/13/2014

NOP Date: 01/23/2015

Construction Finish Date: 02/13/2015

Pipeline Safety Enhancement Program Workpaper Supporting Chapter III

LINE 2001 WEST B REPLACEMENT AND HYDROTEST PROJECT

Construction consisted of replacement of 24 feet of 30 in diameter pipe at Valve Station 21A in Beaumont, MLV 2001-~~493.34~~ 139.76-0. The construction lasted 18 weeks from mobilization to demobilization instead of the planned 9 weeks.

Field Conditions

Conditions were encountered in the field that were not anticipated during design and planning that had to be addressed or mitigated. Listed below is a summary of the key field changes broken down by type of change for this project by section:

Section 10

Constructability Issues:

- A permanent easement was needed for the original MLV design, but could not be acquired from the landowner. This required a design change and delayed the MLV installation. The only viable alternative was in the city owned property that was to be paved. This changed the scope from an above ground to underground MLV in a vault.
- The feed for SL41-167 was changed to outside the limits of the hydrotest on Section 10 in order to provide a continue supply of gas to customers. During construction a simpler design was developed in order to avoid dead end piping. This resulted in an additional delay for redesign and procurement of new materials.

Section 11

Customer Impact Mitigation:

- Due to gas transmission system capacity constraints, the hydrotest was postponed and demobilized on 11/27/14. The project was not able to remobilize until the late spring.
- The City of Beaumont required SoCalGas to backfill the excavation and pave the street due to the delay before remobilizing the construction site.

Pipeline Safety Enhancement Program Workpaper Supporting Chapter III

LINE 2001 WEST B REPLACEMENT AND HYDROTEST PROJECT

Land acquisition issues and permit conditions:

- The laydown yard was located 6.4 miles away from the construction site due to the inability to secure a TRE closer. Section 10's laydown yard was utilized; however, this added logistical complexities with the transport of heavy equipment and materials.

Constructability Issues:

- Footage was added in order to secure an accessible location for the test heads. The tie-in point was moved to avoid impacts to an existing culvert, unknown during design, which added additional footage.

Environmental:

- To support water conservation, the test water was reused for the two hydrotests.

Section 14

Customer impact mitigation:

- Due to system capacity constraints, the hydrotest was postponed and demobilized on 11/27/14. The project was not able to remobilize until the late spring.

Pipeline Safety Enhancement Program Workpaper Supporting Chapter III
LINE 2001 WEST B REPLACEMENT AND HYDROTEST PROJECT

Figure 9: 2001 W Section 10 MLV Installation and Shoring for Vault Construction



Pipeline Safety Enhancement Program Workpaper Supporting Chapter III
LINE 2001 WEST B REPLACEMENT AND HYDROTEST PROJECT

Stages 6 and 7 – Commissioning and Closeout

Commissioning activities included site restoration, final inspections, and placement of the pipeline back into service, transportation and disposal of the hydrotested water or hazardous material and demobilization from the site. Close out activities included development of final drawings, the reconciliation package and updates to company systems to reflect the changes made to the system.

Cost Variance

Table 5: L-2001 West B (Sections 10, 11, 14) Replacement and Hydrotest Project Phase 2 WOA Estimate and Actual Costs

COST SUMMARY					
	PHASE 2 WOA	Estimate of Section 10, 11 & 14	O&M (actuals)	CAPITAL (actuals)	Delta from Estimate Over/(under) Difference between directs for sections worked as compared to actuals
COMPANY LABOR	\$ 953,466	\$ 592,566	\$ 159,526	\$ 448,974	\$ 15,933
CONTRACT COSTS	\$ 4,549,029	\$ 2,589,918	\$ 5,236,965	\$ 1,269,827	\$ 3,916,874
MATERIALS	\$ 500,397	\$ 279,430	\$ 204,883	\$ 109,056	\$ 34,509
OTHER DIRECTS	\$ 4,575,754	\$ 3,007,124	\$ 2,503,081	\$ 1,955,216	\$ 1,451,174
TOTAL DIRECTS	\$ 10,578,646	\$ 6,469,038	\$ 8,104,456	\$ 3,783,073	\$ 5,418,490
INDIRECTS	\$ 1,885,828		\$ 368,034	\$ 769,708	
TOTAL LOADED	\$ 12,464,474		\$ 8,472,490	\$ 4,552,781	

Table 5 compares the Phase 2 WOA estimate for sections 10, 11, 14, 17 and 18/19 and the March 2016 loaded actual costs for sections 10, 11, 14. This project includes \$ 4,552,781 capital for 3 tie-in pieces and 1 cut-out on section 10 and section 14 replacements which totaled 177 feet of pipe. The Phase 2 WOA estimate was calculated using the Stage 3 SCG Pipeline Estimate Template Rev 0 and includes estimated costs for six sections.

The direct cost estimate for the three sections (10, 11 and 14) was \$6,469,038. The total direct actual cost of these sections was \$11,887,529 for O&M and capital. The difference is \$5,418,490. The difference between the estimate and the direct actual costs is attributable to scope changes that occurred after the estimate was developed and due to unanticipated conditions during construction (including: redesign stemming from a City of Banning planned

Pipeline Safety Enhancement Program Workpaper Supporting Chapter III

LINE 2001 WEST B REPLACEMENT AND HYDROTEST PROJECT

roadway; delays and increased costs stemming from permit requirements, valve redesign, and system capacity constraints; redesign to improve operational access; logistical complexities stemming from land acquisition limitations; and scope increase to secure a tie-in point and avoid impacting an existing culvert); and an early cost estimating tool and process that was based on preliminary project designs (resulting in underestimating of inspection activities, engineering, survey, project support, and environmental and water management). These increased costs were reasonably incurred to complete this work, but were not accounted for in the Stage 3 estimate.

Disallowances

There was no disallowance for L-2001 West B (Sections 10, 11, 14) Replacement and Hydrotest as there were no post-1955 segments included in the project without records that provide the minimum information to demonstrate compliance with industry standards or regulatory strength testing and recordkeeping requirements then applicable.

Pipeline Safety Enhancement Program Workpaper Supporting Chapter III
LINE 2001 WEST B REPLACEMENT AND HYDROTEST PROJECT

Conclusion

SoCalGas and SDG&E enhanced the safety of their natural gas system by prudently executing the L-2001 West B (Sections 10, 11 & 14) Replacement and Hydrotest Project. Through this hydrotest and replacement project, SoCalGas and SDG&E successfully replaced 24 feet and hydrotested 2.9348 miles of high pressure transmission pipe in the cities of Banning, Chino Hills and Beaumont. The project incurred a total loaded project cost of \$13,025,271 for O&M and capital.

SoCalGas and SDG&E executed this project prudently: maintaining service to core customers; safely designing and executing the project in a congested area; coordinating operating district work and valve enhancement work to realize efficiencies and minimize community impact; and responding numerous conditions requiring redesign and field changes.

SoCalGas and SDG&E's total loaded project cost of \$13,025,271 for O&M and capital is reasonable and should be approved. SoCalGas and SDG&E engaged in prudent cost avoidance efforts (e.g., reducing Category 4 Criteria mileage and coordinating the PSEP pipeline work with operating district work and valve enhancement work); engaged in reasonable efforts to promote competitive and market-based rates for contractor services and materials (see Chapter II (Phillips) (approximately 98% of PSEP agreements with contractors and suppliers were either competitively bid or through agreements entered into using market-based rates based on a recent competitive sourcing event); and used a reasonable amount of company and contractor resources given the project's complexity, scope changes, and delays.

End of L-2001 West B Hydrotest and Replacement Project Workpaper

Pipeline Safety Enhancement Program Workpaper Supporting Chapter III
LINE 2003 REPLACEMENT AND HYDROTEST PROJECT

Summary

Table 1: Summary of L-2003 (Sections 1, 3 and 4) Replacement and Hydrotest Project

Project Name	L-2003 (Sections 1, 3 and 4) Replacement and Hydrotest Project
WOA Number / Date	91049 / July 9, 2014
Section 1 - Hydrotest	25376 & 91049 / July 9, 2014
Section 3 - Replacement	91049 / July 9, 2014
Section 4 - Replacement	91049 / July 9, 2014
Cities	Downey, Bell Gardens and Los Angeles
Original Pipe Diameter/New Diameter	██████████
Construction Start / Finish:	
Section 1 - Hydrotest	August 20, 2014 / October 27, 2014
Section 3 - Replacement	April 20, 2015 / July 31, 2015
Section 4 - Replacement	November 3, 2014 / November 26, 2014
Loaded Capital Costs	\$7,018,826
Loaded O&M Costs	\$2,592,067
Total Loaded Project Costs	\$9,610,893
Disallowance	\$ 40,120 (Capital)

Background

L-2003 is a high pressure transmission line that runs approximately 26.5 miles, beginning in Downey on East Slauson Ave. The line proceeds west into the City of Los Angeles to Mississippi Ave. where the regulator station is located for MLV 2003-27.00-0. The entirety of Line 2003 is Class 3.

The L-2003 Project was divided into four sections for constructability purposes. At Stage 5, Section 2 was re-scoped and will be submitted for reasonableness review in a future filing.

Pipeline Safety Enhancement Program Workpaper Supporting Chapter III
LINE 2003 REPLACEMENT AND HYDROTEST PROJECT

Description

Through the L-2003 (Sections 1, 3 and 4) Replacement and Hydrotest Project, SoCalGas and SDG&E enhanced its high-pressure transmission pipeline system by successfully replacing 143 feet of primarily [REDACTED] diameter pipe and hydrotesting 1,173 feet of primarily [REDACTED] diameter, as shown in Figures 1 through 8 and Table 2 that describe the project scope as submitted in the 2011 PSEP filing and the final mileage. Included in this project was 647 feet of pipe accelerated from SoCalGas and SDG&E's PSEP Phase 2B. This Phase 2B footage was included to realize efficiencies and to enhance project constructability.¹

An example of cost avoidance actions included:

- Scope validation efforts resulted in a 26.087 reduction of miles.

Construction started with Section 1 in August 2014 and ended with Section 3 in July 2015, incurring a total loaded project cost of \$9,610,893 for all three sections.

¹ SoCalGas and SDG&E, as part of a future Phase 2 application, will include a proposed Phase 2B. PSEP Phase 2B, consistent with the Commission's instructions to bring pipelines into compliance with modern standards for safety, proposes pressure testing or replacing pipelines that have records consistent with then applicable industry standards or regulations, but lack record of a pressure test to modern (49 CFR 192, Subpart J) standards.

Pipeline Safety Enhancement Program Workpaper Supporting Chapter III
LINE 2003 REPLACEMENT AND HYDROTEST PROJECT

Table 2: L-2003 2011 PSEP Filing and Final Mileage*

Line 2003	Total Mileage	Criteria Mileage	Accelerated Mileage**	Incidental Mileage
2011 Filing: Sections 1-4	26.5 mi.	26.225 mi.	0.275 mi.	0
Final Project Mileage				
Section 1	1,173 ft.	544 ft.	629 ft.	0
Section 3	58 ft.	46 ft.	12 ft.	0
Section 4	84 ft.	78 ft.	6 ft.	0
Total	1,315 ft.	668 ft.	647 ft.	0

*Values may not add to total due to rounding.

**Accelerated mileage includes Phase 1B and Phase 2 pipe. Phase 2 includes pipelines without sufficient record of a pressure test in less populated areas (Phase 2A) or pipelines with record of a pressure test, but without record of a pressure test to modern – Subpart J – standards (Phase 2B). Included in this project was 647 feet of pipe accelerated from SoCalGas and SDG&E’s PSEP Phase 2B. This Phase 2B footage was included to realize efficiencies and to enhance project constructability.

Pipeline Safety Enhancement Program Workpaper Supporting Chapter III

LINE 2003 REPLACEMENT AND HYDROTEST PROJECT

Figure 1: Overview Map of L-2003 (Sections 1, 2 and 3) Replacement and Hydrotest Project



Figure 2: Satellite Image of L-2003 (Sections 1, 2 and 3) Replacement and Hydrotest Project



Pipeline Safety Enhancement Program Workpaper Supporting Chapter III
LINE 2003 REPLACEMENT AND HYDROTEST PROJECT

Stage 1 – Project Initiation

In workpapers supporting the 2011 PSEP filing,² SoCalGas and SDG&E identified L-2003 as a Phase 1A hydrotest project. It comprised approximately 26.225 Category 4 Criteria miles and 0.275 accelerated miles.

Upon completion of this scope validation analysis, SoCalGas and SDG&E determined that the existing hydrotest records support the reduction of Category 4 Criteria mileage from 26.225 miles to 729 feet.

² See December 2, 2011 Amended Pipeline Safety Enhancement Plan (PSEP) of SoCalGas and SDG&E.

Pipeline Safety Enhancement Program Workpaper Supporting Chapter III

LINE 2003 REPLACEMENT AND HYDROTEST PROJECT

Stage 2 – Analysis and Findings

During Stage 2, data analysis was performed and the findings were used to define project scope and to plan tasks for later stages of the project.

The following three scenarios were evaluated for each section:

- Replace Criteria footage only
- Test Criteria footage only
- Test a longer section from isolation point to isolation point (MLV to MLV)

Section 1

Engineering Factors

Based on the PSEP Decision Tree, SoCalGas and SDG&E confirmed that the Section 1 project design should commence as a replacement project because the section's scope was less than 1,000 feet. The PSEP Decision Tree directs that scope less than 1,000 feet should be replaced because, under most circumstances, replacements will be the cost effective option. In this instance there were no conditions that justified overriding this guidance.

Sections 2, 3 and 4

Engineering Factors

Based on the PSEP Decision Tree, SoCalGas and SDG&E that the Sections 2, 3 and 4 project designs should proceed as a replacement project because their scopes were less than 1,000 feet. The PSEP Decision Tree directs that scope less than 1,000 feet should be replaced because, under most circumstances, replacements will be the cost effective option. In this instance there were no conditions that justified overriding this guidance.

Pipeline Safety Enhancement Program Workpaper Supporting Chapter III

LINE 2003 REPLACEMENT AND HYDROTEST PROJECT

Stage 3 – Initial Planning and Design

During Stage 3, SoCalGas and SDG&E developed a Phase 2 WOA estimate and began field surveys to complete preliminary design drawings and further refine the scope.

In addition to the schedule and estimate, other key activities include identifying all permits, TREs, and easements, defining long lead materials and pricing, understanding customer impacts and interruptions, and preparing any necessary environmental submittals.

Section 1

Planning and Design Activity

Section 1 is located under power lines which would require a TRE from the owner. From previous experience, it was estimated that it would take up to 2 years to obtain a TRE from the owner. As such, SoCalGas and SDG&E considered a hydrotest option for Section 1 and determined that the estimated cost to hydrotest 1,100 feet or replace 544 feet was approximately the same. Further, there were no known conditions that would preclude the line from being hydrotested. As a result, SoCalGas and SDG&E changed the scope of Section 1 to be a hydrotest project.

- Hydrotest of Line 2003 Section 1 consisted of 544 feet of Category 4 Criteria and an additional 636 feet of pipe totaling 1,180 feet.
- The mobilization date was planned for 8/20/2014 and demobilization on 10/27/2014.
- The Category 4 Criteria Section 1 endpoints were located on either side of the bridge crossing over the Rio Hondo Flood Channel. As a result and for constructability reasons, the test head locations were moved out of the road thus increasing the total test footage.

Additional Consideration

- The lead time of permits

Pipeline Safety Enhancement Program Workpaper Supporting Chapter III
LINE 2003 REPLACEMENT AND HYDROTEST PROJECT

Section 2

Planning and Design Activity

The scope for Section 2 was to replace 220 feet of [REDACTED] diameter pipe, which consisted of 57 feet of Category 4 Criteria and an additional 163 feet of pipe. Section 2 is located in the intersection at La Cienega Blvd. and 104th Street, approximately 20 feet below the ground surface going under an existing large concrete storm drain culvert. Due to its location, for constructability reasons, the tie-in locations were moved out of the intersection thus increasing the footage that was to be replaced. Jack and bore was assumed during the design phase to be the most efficient method to get across the intersection and to go under the concrete storm drain culvert.

Section 3

Planning and Design Activity

Planned construction consisted of replacement of 52 feet of [REDACTED] pipe consisting of 46 feet of Category 4 and an additional 6 feet of pipe with a mobilization date of 4/20/2015 and demobilization on 7/21/2015.

Additional Considerations

- Potential lead time of securing project permits.
- Congested utility corridor could require redesign for pipeline installation.
- High traffic impact adjacent to Los Angeles International Airport (LAX) could result in reduced working hours and other construction area constraints.
- Coordination with other agency construction projects in the area which could complicate scheduling.

Pipeline Safety Enhancement Program Workpaper Supporting Chapter III
LINE 2003 REPLACEMENT AND HYDROTEST PROJECT

Section 4

Planning and Design Activity

- Planned construction to replace 79 feet of Category 4 and an additional 5 foot of pipe.
- Mobilization date of 11/3/14 and demobilization on 11/21/14.

Estimate of Cost

The Phase 2 WOA estimate of total loaded cost for the Line 2003 1, 2, 3 & 4 was \$8,469,271, as shown in Table 3 and was based on preliminary designs. This estimate was prepared in July 2014 using the Stage 3 SCG Pipeline Estimate Template Rev 0 tool.

Table 3: L-2003 Phase 2 WOA Estimate

Cost Category	Phase 2 WOA
Company Labor Costs	\$ 690,287
Contract Costs	\$ 3,284,299
Material Costs	\$ 422,267
Other Direct Costs	\$ 2,942,025
Total Direct Costs	\$ 7,338,878
Total Indirect Costs	\$ 1,130,393
Total Loaded Costs	\$ 8,469,271

Pipeline Safety Enhancement Program Workpaper Supporting Chapter III
LINE 2003 REPLACEMENT AND HYDROTEST PROJECT

Stage 4 – Detailed Engineering Design and Procurement

During Stage 4, detailed design and material procurement was completed in order to provide a construction ready packet to the construction contractor to execute the planned project scope.

Detailed Planning and Design

At Stage 4, the scope for this project remained unchanged from Stage 3.

Construction Contractor Selection

Construction of all sections for Line 2003 utilized the PSEP Performance Partner for this geographic area.

Section 1

The Performance Partner/Construction Contractor TPE was [REDACTED], which is [REDACTED] more than the Stage 3 construction contractor estimate of [REDACTED] that was used to develop the Phase 2 WOA estimate.

Section 2

The Performance Partner/Construction Contractor TPE was [REDACTED], which is [REDACTED] less than the Stage 3 construction contractor estimate of [REDACTED] that was used to develop the Phase 2 WOA estimate.

Section 3

The Performance Partner/Construction Contractor TPE was [REDACTED], which is [REDACTED] ~~less~~ more than the Stage 3 construction contractor estimate of [REDACTED] that was used to develop the Phase 2 WOA estimate.

Pipeline Safety Enhancement Program Workpaper Supporting Chapter III
LINE 2003 REPLACEMENT AND HYDROTEST PROJECT

Section 4

The Performance Partner/Construction Contractor TPE was [REDACTED] which is [REDACTED] [REDACTED] more than the Stage 3 construction contractor estimate of [REDACTED] that was used to develop the Phase 2 WOA estimate.

Pipeline Safety Enhancement Program Workpaper Supporting Chapter III
LINE 2003 REPLACEMENT AND HYDROTEST PROJECT

Stage 5 – Construction

Due to schedule delays, Section 2 was re-scoped to a later date and will be included in a future reasonableness review application.

Section 1

Schedule

Construction Start Date: 08/20/2014

NOP Date: 10/14/2014

Construction Finish Date: 10/27/2014

Construction lasted 5 weeks longer than planned.

Field Conditions

Conditions were encountered in the field that were not anticipated during design and planning that had to be addressed or mitigated. Listed below is a summary of the key field changes broken down by type of change for this section:

Environmental:

- Coal tar wrap was discovered in the soil surrounding the pipe. Abatement of the contaminated soil had to be completed before completing excavation.

Constructability Issues:

- An additional 6 feet of pipe was excavated to expose a nearby valve for servicing.

Site Restoration:

- The City Inspector required curb to curb paving whereas the permit only required paving over the area we disturbed.

Pipeline Safety Enhancement Program Workpaper Supporting Chapter III

LINE 2003 REPLACEMENT AND HYDROTEST PROJECT

Section 3

Schedule

Construction Start Date: 04/20/2015

NOP Date: 06/21/2015

Construction Finish Date: 07/31/2015

Construction lasted 13 weeks from mobilization to demobilization instead of the planned 9 weeks.

Field Conditions

Conditions were encountered in the field that were not anticipated during design and planning that had to be addressed or mitigated. Listed below is a summary of the key field changes broken down by type of change for this section:

Excavation:

- During construction, an additional excavation was needed to confirm the pipe that was marked due to an incorrectly identified pipeline on a construction survey map. The pipe was located adjacent to L-2003.

Changed Permit Conditions:

- The Los Angeles World Airport (LAWA) reduced daily construction time from eight hours to six hours and reduced the length of open trench allowed at any one time in order to reduce impacts on traffic. These had the effect of impacting overall productivity.

Constructability Issues:

- Modifications were required for Section 3 pipe and a nearby fiber-optics substructure. The fiber-optics substructure was 4 feet from Section 3 and the tie-in could not be done safely without modifying another utility's infrastructure.

Pipeline Safety Enhancement Program Workpaper Supporting Chapter III
LINE 2003 REPLACEMENT AND HYDROTEST PROJECT

Section 4

Schedule

Construction Start Date: 11/03/2014

Notice of Operation (NOP): 11/19/2014

Construction Finish Date: 11/26/2014

Construction lasted 3 weeks from mobilization to demobilization instead of the planned 6 weeks. Additionally, it was determined that replacement would minimize customer impacts by reducing the total shut-in time, as this section impacts two regulator stations. An alternate feed to at least one of the regulator stations was required to feed the local distribution pressure district system during the shut-in.

Field Conditions

Conditions were encountered in the field that were not anticipated during design and planning that had to be addressed or mitigated. Listed below is a summary of the key field changes broken down by type of change for this section:

Changed Permit Conditions:

- Restricted construction hours were required by the city which required Saturday work to meet construction deadlines.

Substructures:

A water line in close proximity required additional hand digging to prevent any damage and additional excavation was required to expose and remove a wedding band.

Pipeline Safety Enhancement Program Workpaper Supporting Chapter III
LINE 2003 REPLACEMENT AND HYDROTEST PROJECT

Stages 6 and 7 – Commissioning and Closeout

Commissioning activities included site restoration, final inspections, and placement of the pipeline back into service, transportation and disposal of the hydrotested water or hazardous material and demobilization from the site. Close out activities included development of final drawings, the reconciliation package and updates to company systems to reflect the changes made to the system.

Cost Variances

Table 4: L-2003 (Sections 1, 3 and 4) Replacement and Hydrotest Project Phase 2 WOA Estimate and Actual Costs

COST SUMMARY					
	PHASE 2 WOA	Estimate for Sections 1,3,4	O&M (actuals)	CAPITAL (actuals)	Delta from Estimate Over/(under) Difference between directs for sections worked as compared to actuals
COMPANY LABOR	\$ 690,287	\$ 428,296	\$ 143,170	\$ 253,594	\$ (31,533)
CONTRACT COSTS	\$ 3,284,299	\$ 1,773,610	\$ 1,210,534	\$ 3,735,370	\$ 3,172,294
MATERIALS	\$ 422,267	\$ 343,558	\$ 127,960	\$ 261,265	\$ 45,667
OTHER DIRECTS	\$ 2,942,025	\$ 1,825,418	\$ 927,065	\$ 2,138,623	\$ 1,240,271
TOTAL DIRECTS	\$ 7,338,878	\$ 4,370,881	\$ 2,408,729	\$ 6,388,851	\$ 4,426,699
INDIRECTS	\$ 1,130,393		\$ 183,338	\$ 629,975	
TOTAL LOADED	\$ 8,469,271		\$ 2,592,067	\$ 7,018,826	

Table 4 compares the Phase 2 WOA estimate and the March 2016 total loaded actual costs. The WOA estimate was calculated in Stage 3 using the Stage 3 SCG Pipeline Estimate Template Rev 0. This estimate included Sections 1, 2, 3, and 4. The direct cost estimate of \$4,370,881 is only for Sections 1, 3, 4 (excludes Section 2). The total actual direct cost was \$8,797,580 which includes O&M and Capital, the difference was \$4,426,699.

The above variance is attributable to scope changes and unanticipated conditions that occurred after the Phase 2 WOA estimate (including: environmental abatement, valve servicing, additional paving requirements, additional excavation of a nearby pipe, changed permit conditions, and redesign to avoid substructures). These increased costs were reasonably incurred to complete the replacement, but were not accounted for in the Stage 3 estimate.

Pipeline Safety Enhancement Program Workpaper Supporting Chapter III
LINE 2003 REPLACEMENT AND HYDROTEST PROJECT

Disallowances

For this replacement project, SoCalGas and SDG&E have identified pipe as being installed post 1955 and lacking records that provide the minimum information to demonstrate compliance with industry standards or regulatory strength testing and recordkeeping requirements then applicable. Of the pipeline that was replaced, 125 feet of Phase 1A pipe are disallowed. Therefore, a \$40,120 reduction was made to ratebase calculated by determining the replacement mileage and multiplying the amount by \$1.7 million per mile, which is SoCalGas' and SDG&E's system average cost of pressure testing.

Pipeline Safety Enhancement Program Workpaper Supporting Chapter III

LINE 2003 REPLACEMENT AND HYDROTEST PROJECT

Conclusion

SoCalGas and SDG&E enhanced the safety of their natural gas system by prudently executing the L-2003 (Sections 1, 2 and 3) Hydrotest and Replacement Project. Through this hydrotest and replacement project, SoCalGas and SDG&E successfully replaced 143 feet of pipe and hydrotested 1,173 feet of pipe in the cities of Downey, Bell Gardens and Los Angeles. The project incurred a total loaded project cost of \$9,610,893 which includes both O&M and capital.

SoCalGas and SDG&E executed this project prudently: maintaining service to customers; engaging in scope validation efforts that reduced project mileage; and responding to numerous unanticipated field conditions including redesigns, identification of additional substructures, additional excavation work, and environmental abatement.

SoCalGas and SDG&E's total loaded project cost of \$9,610,893 O&M and capital is reasonable and should be approved (minus acknowledged disallowances). SoCalGas and SDG&E engaged in prudent cost avoidance efforts (reducing project scope); engaged in reasonable efforts to promote competitive and market-based rates for contractor services and materials (see Chapter II (Phillips) (approximately 98% of PSEP agreements with contractors and suppliers were either competitively bid or through agreements entered into using market-based rates based on a recent competitive sourcing event)); and used a reasonable amount of company and contractor resources given the complex scope of work (jack bore construction, congested utility corridor, high traffic impact, and near LAX and a school) and Stage 5 work scope changes (abatement of coal tar wrap, servicing of a nearby valve, changed permit conditions, and hand digging and redesign because of nearby subsurface facilities).

End of L-2003 Hydrotest & Replacement Project Workpaper

Pipeline Safety Enhancement Plan Workpaper Supporting Chapter III
LINE 235 WEST SAWTOOTH CANYON REPLACEMENT PROJECT

Summary

Table 1: Summary of L-235 W Sawtooth Canyon Replacement Project

Project Name	L-235 W Sawtooth Canyon Replacement Project
WOA Number / Date	91088 / September 4, 2014
City	Barstow
Original Pipe Diameter/New Diameter	██████████
Construction Start / Finish	October 09, 2014 / December 12, 2014
Loaded Capital Costs	\$2,050,065
Loaded O&M Costs	\$ 0
Total Loaded Project Costs	\$2,050,065
Disallowance	\$ 0

Background

L-235 West is an approximately 118-mile-long high pressure transmission line made up of primarily ██████████ pipe that runs through the community of Newberry Springs and ends in the city of Santa Clarita. In 2013, a .210-mile portion of L-235 West was reclassified from a Class 1 to a Class 3 location. Due to the class location change, Gas Transmission Operations (GTO) initiated an approximate 1,100-foot replacement project of the newly classified class 3 location pipe. The class location change created two High Consequence Area (HCA) sections on both ends of the class location change. These sections remained in Class 1 location, but were identified as HCA because the identified site was within the potential impact radius. The HCA sections were addressed by PSEP as part of the L-235W Sawtooth Canyon Replacement Project. The HCA lengths of the PSEP sections resulting from the reclassification were 859 feet and 851 feet on either end of the class location change replacement work. Gas Control set a deadline of December 12, 2014 to put the line back in service to support winter demand.

GTO and PSEP coordinated construction efforts to address the replacement of the class location section and the new HCA sections. GTO would be responsible for addressing segments within the class location change in accordance with SoCalGas and SDG&E's class

Pipeline Safety Enhancement Plan Workpaper Supporting Chapter III
LINE 235 WEST SAWTOOTH CANYON REPLACEMENT PROJECT

location change requirements. PSEP would be responsible for the lengths of pipe that fall into the HCA outside of the location class limits.

Description

Through the L-235 W Sawtooth Canyon Replacement Project, SoCalGas and SDG&E enhanced its high-pressure transmission pipeline system by successfully replacing 1,710 feet of [REDACTED] diameter pipe, as shown in Figures 1 through 6 and Table 2 that describes the project scope as submitted in the 2011 PSEP filing and the final mileage.

An example of cost avoidance action included:

- By coordinating this project with the GTO project, efficiencies were realized through requiring only one blow down, using the existing permits and land rights secured for the GTO project, and eliminating three separate post construction pressure tests for the three replacement pipeline sections.

Construction began in October 2014 and was completed in December 2014. The L-235 W Sawtooth Canyon Project incurred a total loaded project cost of \$2,050,065.

Table 2: L-235 West Sawtooth Canyon 2011 PSEP Filing and Final Mileage*

L-235 West Sawtooth Canyon	Total Mileage	Criteria Mileage	Accelerated Mileage	Incidental Mileage
2011 PSEP Filing	3.10 mi.	2.74 mi.	0.356 mi.	0
Total	1,710 ft.	1,647 ft.	0	63 ft.

* Values may not add to total due to rounding.

Pipeline Safety Enhancement Plan Workpaper Supporting Chapter III
LINE 235 WEST SAWTOOTH CANYON REPLACEMENT PROJECT

Stage 1 and 2 – Project Initiation, Analysis and Findings

This project was planned and executed by the GTO with PSEP oversight. This project implemented a modified stage gate review process instead of the formal PSEP Seven Stage Review Process. As discussed previously, in the fall 2013, SoCalGas and SDG&E determined that the section in Sawtooth Canyon had a location class change and required replacement to meet the new class location requirements. Two short PSEP sections (859 feet and 851 feet) were identified as being immediately adjacent on either side of the GTO replacement project. To increase efficiencies, the PSEP sections were added for GTO to manage as part of the existing project already underway and to take advantage of and leverage the existing analysis, surveys, design and permitting, isolation plans, already developed to complete this project.

Engineering Factors

Based on the PSEP Decision Tree, SoCalGas and SDG&E confirmed that the project design should remain a replacement. The PSEP Decision Tree directs that scopes less than 1,000 feet should be replaced because, under most circumstances, replacements will be the cost effective option. Replacement was also justified because the existing HCA pipeline segments could not be tested to the required level without overstressing the pipe, thus requiring replacement of the segments.

The PSEP project schedule was advanced to match the GTO project and meet Gas Control's deadline to put the line back in service to meet the winter demand.

Pipeline Safety Enhancement Plan Workpaper Supporting Chapter III
LINE 235 WEST SAWTOOTH CANYON REPLACEMENT PROJECT

Stage 3 – Initial Planning and Design

During Stage 3, SoCalGas and SDG&E developed a Phase 2 WOA estimate. The GTO designed and managed the project.

Planning and Design Activity

The proposed design was to replace the identified pipe entirely, removing the existing pipe and placing the new pipe into the same trench. It was necessary to remove the existing pipe in order to make space for the replacement pipe within the existing right of way.

The assumptions included in initial engineering design are as follows:

- PSEP to replace 1,710 feet of [REDACTED] diameter pipe in two sections.
- The pipeline could be taken out of service without customer impacts as long as it was returned to service by the Gas Control specified date.

Estimate of Costs

The estimated total loaded cost for the 1,710 feet PSEP replacement sections of L-235 W Sawtooth Canyon was \$3,620,957 as shown in Table 3 below. This estimate was prepared in September 2014 using the Stage 3 SCG Pipeline Estimate Template Rev 1 estimating tool.

Pipeline Safety Enhancement Plan Workpaper Supporting Chapter III
LINE 235 WEST SAWTOOTH CANYON REPLACEMENT PROJECT

Table 3: L-235 W Sawtooth Canyon Phase 2 WOA Estimate

Cost Category	Phase 2 WOA
Company Labor Costs	\$252,045
Contract Costs	\$1,186,506
Material Costs	\$415,166
Other Direct Costs	\$1,317,543
Total Direct Costs	\$3,171,260
Total Indirect Costs	\$449,697
Total Loaded Costs	\$3,620,957

Pipeline Safety Enhancement Plan Workpaper Supporting Chapter III
LINE 235 WEST SAWTOOTH CANYON REPLACEMENT PROJECT

Stage 4 – Detailed Engineering Design and Procurement

Detailed Planning and Design

The engineering design for Line 235 W Sawtooth Canyon remained the same as at Stage 3.

The GTO group developed the procedure for tie-in of the 2,823 ft. segment to Line 235 W Sawtooth Canyon.

The following assumptions were included in the detailed engineering design:

- Replacement of an 859-foot segment and an 851-foot segment of [REDACTED] pipe.
- Work would be limited to 10 hour days.

Construction Contractor Selection

The project was sourced to the construction contractor that was competitively bid for the GTO project. The following was considered prior to proceeding:

- Using the same contractor allowed for one mobilization and demobilization.

The Construction Contractor “not to exceed contract” was \$ [REDACTED] which is \$ [REDACTED] less than the Stage 3 construction contractor direct estimate of \$ [REDACTED]

Pipeline Safety Enhancement Plan Workpaper Supporting Chapter III
LINE 235 WEST SAWTOOTH CANYON REPLACEMENT PROJECT

Stage 5 – Construction

Schedule

Construction Start Date: 10/09/2014

NOP Date: 12/06/2014

Construction Finish Date: 12/12/2014

The construction lasted nine weeks rather than the planned eighteen weeks from mobilization to demobilization with no project delays.

Field Conditions

There were no field conditions that required mitigating.

Pipeline Safety Enhancement Plan Workpaper Supporting Chapter III
LINE 235 WEST SAWTOOTH CANYON REPLACEMENT PROJECT

Stages 6 and 7 – Commissioning and Closeout

Commissioning activities included site restoration, final inspections, and placement of the pipeline back into service, transportation and disposal of the hydrotested water or hazardous material and demobilization from the site. Close out activities included development of final drawings, the reconciliation package and updates to company systems to reflect the changes made to the system.

Table 4: L-235W Sawtooth Canyon Replacement Project Phase 2 WOA Estimate and Actual Costs

COST SUMMARY			
	PHASE 2 WOA	CAPITAL (actuals)	DELTA over/(under)
COMPANY LABOR	\$ 252,045	\$ 91,831	\$ (160,214)
CONTRACT COSTS	\$ 1,186,506	\$ 1,084,676	\$ (101,830)
MATERIALS	\$ 415,166	\$ 282,509	\$ (132,657)
OTHER DIRECTS	\$ 1,317,543	\$ 424,625	\$ (892,918)
INDIRECTS	\$ 449,697	\$ 166,425	\$ (283,272)
TOTAL LOADED	\$ 3,620,957	\$ 2,050,065	\$ (1,570,892)

Table 4 compares the Phase 2 WOA estimate and the March 2016 total loaded actual costs. These costs only reflect the PSEP replacement sections. The Phase 2 WOA estimate was calculated using the Stage 3 SoCalGas Pipeline Estimate Template Rev.1. The total loaded actual costs were \$1,570,892 less than the estimate due to the cost estimating tool overestimating engineering and design, survey, permits and environmental activities. The overestimation was due to the lack of difficult design issues and coordination with the GTO project.

Disallowances

There was no disallowance for line L-235W Sawtooth Canyon Replacement as there were no post-1955 segments included in the project without records that provide the minimum information to demonstrate compliance with industry standards or regulatory strength testing and recordkeeping requirements then applicable. As explained below, although this portion of

Pipeline Safety Enhancement Plan Workpaper Supporting Chapter III
LINE 235 WEST SAWTOOTH CANYON REPLACEMENT PROJECT

L-235W was installed in 1957, SoCalGas and SDG&E have records that provide the minimum information to demonstrate compliance with industry standards then applicable.

Line 235W Sawtooth Canyon has record of a pressure test to 1.1 times MAOP that occurred in 1957, when the line was located in a Class 1 location. Since Line 235W Sawtooth Canyon had a pressure test to 1.1 times MAOP when it was located in a Class 1 location, it has pressure test records that provide the minimum information to demonstrate compliance with then applicable industry strength testing and record keeping standards.¹ In 2013, however, portions of Line 235W Sawtooth Canyon were identified as being in HCAs due to the identification of a nearby campground. As a result, because a segment of Line 235W in Sawtooth Canyon is now located in an HCA and lacks a pressure test to 1.25 times MAOP, it must be addressed as part of PSEP Phase 1A. Thus, SoCalGas has sufficient record of a pressure test from 1957, but must still address Line 235W Sawtooth Canyon as part of PSEP Phase 1A because of recent developments in the area.

¹ See ASA B31.1 – 1955 Section 841.412(a).

Pipeline Safety Enhancement Plan Workpaper Supporting Chapter III
LINE 235 WEST SAWTOOTH CANYON REPLACEMENT PROJECT

Conclusion

SoCalGas and SDG&E prudently executed the 235 West Sawtooth Canyon Replacement Project. Through this replacement project, SoCalGas and SDG&E successfully replaced 1,710 feet of pipe in December 2014. The project incurred a total loaded project cost of \$2,050,065.

SoCalGas and SDG&E executed this project prudently: engaging in prudent cost avoidance efforts and executing the project in coordination with the SoCalGas GTO so as to complete the work efficiently and as soon as practicable.

SoCalGas and SDG&E's total loaded project cost of \$2,050,065 is reasonable and should be approved. SoCalGas and SDG&E engaged in prudent cost avoidance efforts (realizing efficiencies by coordinating work with GTO); engaged in reasonable efforts to promote competitive and market-based rates for contractor services and materials (see Chapter II (Phillips) (approximately 98% of PSEP agreements with contractors and suppliers were either competitively bid or through agreements entered into using market-based rates based on a recent competitive sourcing event)); and used a reasonable amount of company and contractor resources.

End of 235 W Sawtooth Canyon Replacement Project Workpaper

Pipeline Safety Enhancement Plan Workpaper Supporting Chapter III
LINE 33-120 SECTION 2 REPLACEMENT PROJECT

Summary

Table 1: Summary of SL-33-120 Section 2 Replacement Project

Project Name	SL-33-120 Section 2 Replacement Project
Project Type	Replacement
WOA Number/ WOA Date	82056 / December 18, 2013
City	Van Nuys (City of LA)
Original Pipe Diameter/ New Pipe Diameter	██████████
Construction Start/ Construction Finish	June 23, 2014/ September 19, 2014
Loaded Capital Costs	\$7,634,170
Loaded O&M Costs	\$ 0
Total Loaded Project Costs	\$7,634,170
Disallowance	\$ 0

Description

Through the SL-33-120 Section 2 Replacement Project, SoCalGas and SDG&E enhanced its high pressure pipeline system by replacing 0.279 miles of pipeline, as shown in Figures 1 and 2 and Table 2 which describes the project scope as submitted in the 2011 PSEP filing and the final construction as-built mileage.

Examples of cost avoidance actions included:

- SoCalGas and SDG&E were successful in negotiating a better paving option for a third-party’s parking lot that involved fewer paving mobilizations.
- Through scope validation efforts, SoCalGas and SDG&E reduced scope mileage.

Construction began in June 2014 and was completed in September 2014. The SL-33-120 Section 2 Replacement Project incurred a total loaded project cost of \$7,634,170.

Pipeline Safety Enhancement Plan Workpaper Supporting Chapter III
LINE 33-120 SECTION 2 REPLACEMENT PROJECT

Table 1: SL-33-120 Section 2 - 2011 PSEP Filing and Final Mileage*

Line 33-120 Section 2	Total Mileage	Criteria Mileage	Accelerated Mileage**	Incidental Mileage
2011 PSEP Filing (all Sections)	1.252	0.387	0.865	0
Total	0.279	0.273	32	0

*Values may not add to total due to rounding.

**Accelerated Mileage includes Phase 1B and Phase 2 pipe. Phase 2 includes pipelines without sufficient record of a pressure test in less populated areas (Phase 2A) or pipelines with record of a pressure test, but without record of a pressure test to modern – Subpart J – standards (Phase 2B). Included in this project was 32 feet of pipe accelerated from SoCalGas and SDG&E’s PSEP Phase 2B. This Phase 2B footage was included to realize efficiencies and to enhance project constructability.

Figure 1: Overview Map of SL-33-120 Section 2



Pipeline Safety Enhancement Plan Workpaper Supporting Chapter III
LINE 33-120 SECTION 2 REPLACEMENT PROJECT

Figure 2: Satellite Image of SL-33-120 Section 2



Pipeline Safety Enhancement Plan Workpaper Supporting Chapter III
LINE 33-120 SECTION 2 REPLACEMENT PROJECT

Stage 1 – Project Initiation

In workpapers supporting the 2011 PSEP filing,¹ SoCalGas and SDG&E identified the SL-33-120 project as a 1.252-mile replacement project. SL-33-120 is a high-pressure pipeline of primarily [REDACTED] diameter pipe that runs through the community of Van Nuys within the city of Los Angeles.

During Stage 1, SoCalGas and SDG&E completed scope validation analysis of the SL-33-120 Section 2 Project and verified that:

- SL-33-120 Section 2 was installed in 1940.
- The overall project scope length decreased from the filing due to scope validation.

¹ See December 2, 2011 Amended Pipeline Safety Enhancement Plan (PSEP).

Pipeline Safety Enhancement Plan Workpaper Supporting Chapter III
LINE 33-120 SECTION 2 REPLACEMENT PROJECT

Stage 2 – Analysis and Findings

During Stage 2, data analysis was performed and the findings were used to define project scope and to plan tasks for later stages of the project.

Engineering Factors

- A PSEP Decision Tree analysis of SL-33-120 Section 2 confirmed that the project design should commence as a replacement project because SL-33-120 Section 2 was installed in 1940 and is non-piggable. The PSEP Decision Tree directs that pre-1946, non-piggable Gas Transmission pipe should be replaced. The analysis supported the decision to replace the pipe.
- It was determined prudent to split SL-33-120 into three sections (1, 2, and 3) because further in-depth analysis was necessary for Sections 1 and 3. As such, executing all sections would mean pushing the construction start date to 2016. The revised scope of SL-33-120 was determined to be 0.279 total miles.

Pipeline Safety Enhancement Plan Workpaper Supporting Chapter III
LINE 33-120 SECTION 2 REPLACEMENT PROJECT

Stage 3 – Initial Planning and Design

During Stage 3, SoCalGas and SDG&E developed a Phase 2 WOA estimate, and began field surveys to complete preliminary design drawings and further refine scope. In addition to the schedule and estimate, other key activities include identifying all permits, TREs, and easements, defining long lead materials and pricing, understanding customer impacts and interruptions, and preparing any necessary environmental submittals.

Planning and Design Activity

The initial planning design for SL-33-120 Section 2 was to occur as follows:

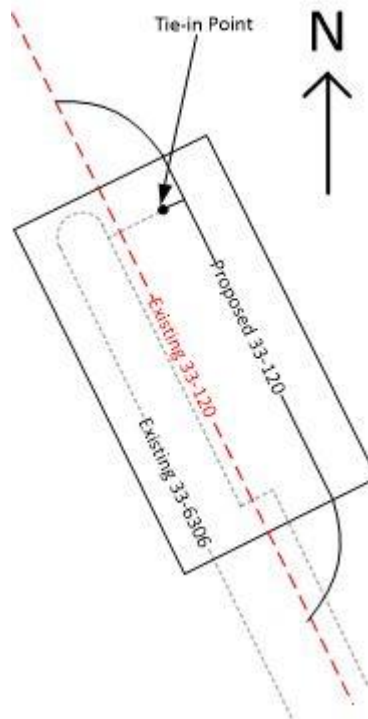
- Replacement piping would be installed using a cold tie-in.
- Existing SL-33-120 Section 2 pipeline would be abandoned in place.

Additional Considerations

- One mobilization and demobilization.
- Day work for the entire project.
- No foreseeable environmental impact because of project location.
- No additional permits would be necessary.
- Project team would tie-in to Regulator Station ID 914-N on the east side of SL-33-120 (see Figure 3).

Pipeline Safety Enhancement Plan Workpaper Supporting Chapter III
LINE 33-120 SECTION 2 REPLACEMENT PROJECT

Figure 3: Proposed tie-in to Regulator Station ID 914-N along SL-33-120 Section 2



Pipeline Safety Enhancement Plan Workpaper Supporting Chapter III
LINE 33-120 SECTION 2 REPLACEMENT PROJECT

Estimate of Costs

The estimated total loaded cost for the 1,515 feet of [REDACTED] pipe was \$5,032,172, as shown in Table 5, and is based on preliminary designs. This estimate was prepared in December 2013 using the Stage 3 SCG Pipeline Estimate Template Rev 0 tool.

Table 3: SL-33-120 Section 2 Phase 2 WOA Estimate

Cost Category	Phase 2 WOA
Company Labor Costs	\$ 322,870
Contract Costs	\$ 0
Material Costs	\$ 567,489
Other Direct Costs	\$ 3,203,853
Total Direct Costs	\$ 4,094,212
Total Indirect Costs	\$ 937,960
Total Loaded Costs	\$ 5,032,172

Pipeline Safety Enhancement Plan Workpaper Supporting Chapter III
LINE 33-120 SECTION 2 REPLACEMENT PROJECT

Stage 4 – Detailed Engineering Design and Procurement

During Stage 4, detailed design and material procurement was completed in order to provide a construction ready packet to the construction contractor to execute the planned project scope.

Detailed Planning and Design

- The RER directed that a [REDACTED] bypass would be necessary as opposed to the initial [REDACTED] bypass.
- Potholing determined the proposed location for the pressure control fittings had insufficient cover. In order to prevent undue stress on the fittings, the project team ordered a custom vault to house the fittings.
- Shortly before construction start, the Army Corp of Engineers issued its permit requiring the abandoned pipeline be removed. The initial assumption was to abandon in place.
- It was assumed that the project would be completed with day work. After negotiating with local businesses, SoCalGas changed the plan to execute certain portions of the project at night.
- Redesign was needed to realign the pipe to provide sufficient space for construction operations.
- To avoid potential damage to an oak tree the route in the vicinity of the oak tree was redesigned.
- K-rails were necessary to provide safe working conditions for a portion of the route.
- The project team anticipated the need for a Noise Variance from the Los Angeles Police Department.

Construction Contractor Selection

Construction of the SL-33-120 Section 2 Project utilized the PSEP Performance Partner Program and the construction contract was awarded to the Performance Partner selected for this geographic area.

Pipeline Safety Enhancement Plan Workpaper Supporting Chapter III
LINE 33-120 SECTION 2 REPLACEMENT PROJECT

The Performance Partner/Construction Contractor TPE was \$ [REDACTED], which is \$ [REDACTED] more than the Stage 3 construction contractor direct estimate of \$ [REDACTED] that was used to develop the Phase 2 WOA estimate.

Pipeline Safety Enhancement Plan Workpaper Supporting Chapter III
LINE 33-120 SECTION 2 REPLACEMENT PROJECT

Stage 5 – Construction

Schedule

Construction Start Date: 06/23/2014

NOP Date: 09/05/2014

Construction Finish Date: 09/19/2014

Field Conditions

Conditions were encountered in the field that were not anticipated during design and planning that had to be addressed or mitigated. These conditions impacted the project scope and schedule.

During the price negotiation it was determined that final paving would need to be completed in three mobilizations within a third-party property owner's parking lot. After construction started, SoCalGas and SDG&E were able to negotiate the use of 1.5 sack slurry up to existing grade as temporary paving and subsequently permanently pave the entire alignment in one mobilization.

Constructability Issues

- The initial design assumed that existing SL-33-120 would be in the centerline of SoCalGas' 10-foot easement (see Figure 4). Initial trenching by the contractor found that the existing pipeline varied within the [REDACTED] wide easement. This could create conflicts with the proposed location of the new pipe. In lieu of handdigging the entire pipeline, to avoid hitting the existing [REDACTED] pipeline, the decision was made to slot trench the entire pipeline. Slot trenching is the process of digging narrow trenches. Because slot trenching the entire pipeline is so intensive, two vacuum trucks were used instead of one. The second vacuum truck would perform work ahead of the crews. In addition, slot trenching was a factor that limited efficiencies because the performance partner could

Pipeline Safety Enhancement Plan Workpaper Supporting Chapter III
LINE 33-120 SECTION 2 REPLACEMENT PROJECT

move only as fast as the slot trenches could be dug. These changes affected project costs.

- The stopple mechanism was unable to achieve a complete seal. As a result, the project team had to forgo the planned cold tie-in and perform a hot tie-in. This pipeline feeds a major cogeneration plant that is vital for cooling during the summer and as a result, the hot tie-in had to be coordinated with the cogeneration plant.

Substructures:

- The project design assumed the tie-in point to Regulator Station ID 914-N would be east of the existing SL-33-120 pipeline. However, during construction, a concrete thrust block was discovered within the proposed alignment. This discovery resulted in a major realignment to the west side of the existing SL-33-120 pipeline.

Pipeline Safety Enhancement Plan Workpaper Supporting Chapter III
LINE 33-120 SECTION 2 REPLACEMENT PROJECT

Stages 6 and 7 – Commissioning and Closeout

Commissioning activities included site restoration, final inspections, and placement of the pipeline back into service, transportation and disposal of the hydrotested water or hazardous material and demobilization from the site. Close out activities included development of final drawings, the reconciliation package and updates to company systems to reflect the changes made to the system.

Cost Variance

Table 4: SL 33-120 Phase 2 WOA Estimate and Actual Costs

COST SUMMARY			
	PHASE 2 WOA	CAPITAL (actuals)	DELTA over/(under)
COMPANY LABOR	\$ 322,870	\$ 348,938	\$ 26,068
CONTRACT COSTS	\$ -	\$ 4,455,660	\$ 4,455,660
MATERIALS	\$ 567,489	\$ 427,625	\$ (139,864)
OTHER DIRECTS	\$ 3,203,853	\$ 1,807,295	\$ (1,396,558)
INDIRECTS	\$ 937,960	\$ 594,652	\$ (343,308)
TOTAL LOADED	\$ 5,032,172	\$ 7,634,170	\$ 2,601,998

Table 4 compares the Phase 2 WOA estimate and the March 2016 loaded actual costs. The loaded actual costs exceeded the Phase 2 WOA estimate by \$2,601,998.

The above variance is attributable to scope changes and unanticipated conditions that occurred after the Phase 2 WOA estimate (including: installation of a larger bypass; acquisition of a custom vault to prevent undue stress on the fittings; increased permit requirements required removal of pipe instead of abandonment; night work; redesign to provide sufficient construction space; installation of k-rails to enhance safety; and identification of substructures required slot trenching, second vacuum truck, redesign, and pipeline realignment) and an early cost estimating tool and process that was based on preliminary project designs (resulting in underestimating of construction contractor costs, project support costs, and indirects). These

Pipeline Safety Enhancement Plan Workpaper Supporting Chapter III
LINE 33-120 SECTION 2 REPLACEMENT PROJECT

increased costs were reasonably incurred to complete the replacement, but were not accounted for in the Stage 3 estimate.

Disallowances

There was no disallowance for SL-33-120 Section 2 Replacement Project as there were no post-1955 segments included in the project without records that provide the minimum information to demonstrate compliance with industry standards or regulatory strength testing and recordkeeping requirements then applicable.

Pipeline Safety Enhancement Plan Workpaper Supporting Chapter III
LINE 33-120 SECTION 2 REPLACEMENT PROJECT

Conclusion

SoCalGas and SDG&E enhanced the safety of their natural gas system by prudently executing the SL-33-120 Section 2 Replacement Project. Through this replacement project, SoCalGas and SDG&E successfully replaced 0.279 miles of continuous pipe in the community of Van Nuys within the city of Los Angeles. The project incurred a total loaded project cost of \$7,634,170.

SoCalGas and SDG&E executed this project prudently: coordinating with customers to minimize customer impact; engaging in scope validation efforts that reduced project mileage; enhancing piggability through the replacement of pre-1946, non-piggable pipe; separately addressing sections to accomplish the Commission's directive to complete work as soon as practicable; and responding to numerous unanticipated field conditions, including complicated substructure conflicts, stopple seal challenges, and the addition of slot trenching activities.

SoCalGas and SDG&E's total loaded project cost of \$7,634,170 is reasonable and should be approved. SoCalGas and SDG&E engaged in prudent cost avoidance efforts (reducing mobilizations within a third party property owner's parking lot and reducing project scope); engaged in reasonable efforts to promote competitive and market-based rates for contractor services and materials (see Chapter II (Phillips) (approximately 98% of PSEP agreements with contractors and suppliers were either competitively bid or through agreements entered into using market-based rates based on a recent competitive sourcing event)); and used a reasonable amount of company and contractor resources given the complex scope of work (night work and slot trenching) and work scope changes (engineering redesigns driven by substructures).

End of SL-33-120 Section 2 Replacement Project

Pipeline Safety Enhancement Plan Workpaper Supporting Chapter III
LINE 35-20-N REPLACEMENT PROJECT

Summary

Table 1: Summary of SL-35-20-N Replacement Project

Project Name	SL-35-20-N Replacement Project
WOA Number/WOA Date	82016/January 2, 2013
City	Newport Beach
Original Pipe Diameter/New Pipe Diameter	██████
Construction Start/ Construction Finish	August 11, 2014 / September 5, 2014
Loaded Capital Costs	\$ 284,661
Loaded O&M Costs	\$ 0
Total Loaded Project Costs	\$ 284,661
Disallowance	\$ 17,340

Description

Through the SL-35-20-N Replacement Project, SoCalGas and SDG&E enhanced its pipeline system by successfully replacing 69 feet of high-pressure, ██████ diameter pipe with ██████ diameter pipe in the city of Newport Beach, as shown in Figures 1 and 2 and Table 2 that describes the project scope as submitted in the 2011 PSEP filing and the final mileage.

An example of cost avoidance actions included:

- Installed ██████ pipe rather than replacing kind-for-kind with ██████ pipe.

Construction began in August 2014 and was completed in September 2014, with a final scope of 54 feet of Category 4 Criteria and 13 feet of Incidental pipe. The project incurred a total loaded project cost of \$284,661.

Pipeline Safety Enhancement Plan Workpaper Supporting Chapter III
LINE 35-20-N REPLACEMENT PROJECT

Table 2: SL-35-20-N - 2011 PSEP Filing and Final Mileage*

	Total Mileage	Criteria Mileage	Accelerated Mileage	Incidental Mileage
2011 CPUC Filing	0.010 mi.	0.010 mi.	0	0
Total	69 ft.	54 ft.	0	15 ft.

**Values may not add to total due to rounding.*

Pipeline Safety Enhancement Plan Workpaper Supporting Chapter III
LINE 35-20-N REPLACEMENT PROJECT

Figure 1: Overview Map of SL-35-20-N Replacement Project



Pipeline Safety Enhancement Plan Workpaper Supporting Chapter III
LINE 35-20-N REPLACEMENT PROJECT

Stages 1 & 2 – Project Initiation / Analysis and Findings

The PSEP Organization was not yet fully functional at the initiation of this project. As a result, the project was planned and executed by the SoCalGas Distribution Operating Regions.

Additionally, this project was initiated before the implementation of the formal PSEP Seven Stage Review Process and was accordingly not subject to that process. Rather, a similar decision methodology was employed that incorporated many of the same attributes and goals that form the foundation for the Seven Stage Review Process.

In workpapers supporting the 2011 PSEP filing,¹ SoCalGas and SDG&E identified the SL-35-20-N project as a 53 foot Phase 1A replacement project.

At the time of the 2011 filing, the proposed scope was 53 feet, all of which was Category 4 Criteria pipe. The pipeline is located in the city of Newport Beach.

SoCalGas and SDG&E completed scope validation, confirming that SL-35-20-N was first installed in 1963.

Engineering Factors

SoCalGas and SDG&E performed a PSEP Decision Tree analysis of SL-35-20-N that confirmed the project design should commence as a replacement project because the scope was less than 1,000 feet. The PSEP Decision Tree directs that scope less than 1,000 feet should be replaced because it is the more cost effective option. In this instance there were no conditions that justified overriding this guidance.

During the design and planning process it was determined that an additional 13 feet of [REDACTED] pipe, was required to complete the tie-in. Rather than cut into pipe where it transitioned from Category 4 to Category 1, SoCalGas extended the replacement 13 feet to the flanged connection at the inlet of a regulator station. This additional pipe served to simplify the

¹ See December 2, 2011 Pipeline Safety Enhancement Plan (PSEP) of SoCalGas and SDG&E.

Pipeline Safety Enhancement Plan Workpaper Supporting Chapter III
LINE 35-20-N REPLACEMENT PROJECT

construction excavation, the pressure test isolation, and the tie-in work to the existing distribution regulator station on the west end of the replacement.

Pipeline Safety Enhancement Plan Workpaper Supporting Chapter III
LINE 35-20-N REPLACEMENT PROJECT

Stages 3 and 4 – Initial Planning, Detailed Engineering Design and Procurement

Planning and Design Activity

During Stages 3 and 4, SoCalGas and SDG&E completed detailed engineering design work and contractor selection. The SoCalGas Distribution Operating Regions designed and managed the project. The material requirements and the project cost estimate were determined by the planner representing the operating district.

Additional Considerations

- Replacement of 13 feet of [REDACTED] and 54 feet of [REDACTED] pipe with 69 feet of [REDACTED] pipe utilizing engineering analysis recommendation. The additional two feet was added due to an offset (i.e. new pipeline route).
- One mobilization and demobilization.
- Normal daylight work hours—5-day work week.

Estimate of Costs

The estimated total loaded cost for the pipeline project was \$281,658, as shown in Table 3. This estimate was prepared using the SoCalGas Distribution Operating Regions' Construction Management System (CMS). Upon receipt of the Contractor's quote the construction cost was also updated in a pre-construction Phase 2 Reauthorized WOA dated 5/19/14.

Pipeline Safety Enhancement Plan Workpaper Supporting Chapter III
LINE 35-20-N REPLACEMENT PROJECT

Table 3: SL-35-20-N Phase 2 WOA and Phase 2 Reauthorized WOA Estimate

Cost Category	Phase 2 WOA	Phase 2 Reauthorized WOA 05/19/14
Company Labor Costs	\$9,495	\$33,175
Contract Costs	\$75,267	\$117,386
Material Costs	\$1,410	\$1,500
Other Direct Costs	\$33,241	\$85,000
Total Direct Costs	\$119,413	\$237,061
Total Indirect Costs	\$51,863	\$44,597
Total Loaded Costs	\$171,267	\$281,658

Construction Contractor Selection

SoCalGas’ Distribution Operating Region had previously selected a Single Source contractor from a competitively bid Master Service Agreement (MSA) to perform work for the region. PSEP used the same contractor at comparable rates to complete this project.

The Construction Contractor’s bid was \$ [REDACTED], which was \$ [REDACTED] less than the CMS direct estimate of \$ [REDACTED] that was used to develop the Phase 2 WOA estimate.

Pipeline Safety Enhancement Plan Workpaper Supporting Chapter III
LINE 35-20-N REPLACEMENT PROJECT

Stage 5 – Construction

Schedule

Construction Start Date: 08/11/2014

NOP Date: 08/29/2014

Construction Finish Date: 09/05/2014

Field Conditions

There were no scope changes or unanticipated field conditions.

Pipeline Safety Enhancement Plan Workpaper Supporting Chapter III
LINE 35-20-N REPLACEMENT PROJECT

Stages 6 and 7 – Commissioning and Closeout

Commissioning activities included site restoration, final inspections, and placement of the pipeline back into service, transportation and disposal of the hydrotested water or hazardous material and demobilization from the site. Close out activities included development of final drawings, the reconciliation package and updates to company systems to reflect the changes made to the system.

Cost Variance

Table 4: SL-35-20N Phase 2 Reauthorized WOA Estimate and Actual Costs

COST SUMMARY				
	PHASE 2 WOA	CAPITAL (actuals)	DELTA over/(under)	
COMPANY LABOR	\$ 33,175	\$ 46,261	\$	13,086
CONTRACT COSTS	\$ 117,386	\$ 82,632	\$	(34,754)
MATERIALS	\$ 1,500	\$ 1,345	\$	(155)
OTHER DIRECTS	\$ 85,000	\$ 99,898	\$	14,898
INDIRECTS	\$ 44,597	\$ 54,526	\$	9,929
TOTAL LOADED	\$ 281,658	\$ 284,661	\$	3,003

Table 4 compares the Reauthorized Phase 2 WOA estimate and the March 2016 total loaded actual costs. The total loaded actual costs were \$3,003 more than the Phase 2 Reauthorized WOA estimate. The Phase 2 WOA estimate was calculated using the SoCalGas Distribution Organization’s estimating tool, CMS. Subsequently in Stage 4, based on the contractor’s quote, the estimate was updated and the Phase 2 Reauthorized WOA (pre-construction) was approved. The reauthorized WOA adequately accounted for the work to be performed to complete this replacement work. As discussed above and summarized in the conclusion, this project was completed prudently and reasonably.

Disallowances

For this replacement project, SoCalGas and SDG&E has identified pipe as being installed post 1961 and lacking records that provide the minimum information to demonstrate compliance with

Pipeline Safety Enhancement Plan Workpaper Supporting Chapter III
LINE 35-20-N REPLACEMENT PROJECT

regulatory strength testing and recordkeeping requirements then applicable. Of the pipeline that was replaced, 54 feet of Phase 1A pipe are disallowed. Therefore a \$17,340 reduction was made to ratebase calculated by determining the replacement mileage and multiplying the amount by \$1.7 million per mile, which is SoCalGas' and SDG&E's system average cost of pressure testing.

Pipeline Safety Enhancement Plan Workpaper Supporting Chapter III
LINE 35-20-N REPLACEMENT PROJECT

Conclusion

SoCalGas and SDG&E successfully and prudently executed the SL-35-20-N Replacement Project. Through this replacement project, SoCalGas and SDG&E successfully replaced 67 feet of existing pipe and added 2 feet of new incidental pipe in August 2014. The project incurred a total loaded project cost of \$284,661.

SoCalGas and SDG&E executed this project prudently: minimizing customer impact; prudently designing the project to include incidental pipe to simplify the construction excavation, the pressure test isolation, and the tie-in work to the existing distribution regulator station on the west end of the replacement; and executing the work with Distribution Operating Region resources to complete the replacement as soon as practicable..

SoCalGas and SDG&E's total loaded project cost of \$284,661 is reasonable and should be approved (minus acknowledged disallowances). SoCalGas and SDG&E engaged in prudent cost avoidance efforts (installing [REDACTED] pipe rather than replacing kind-for-kind with [REDACTED] pipe); engaged in reasonable efforts to promote competitive and market-based rates for contractor services and materials (see Chapter II (Phillips) (approximately 98% of PSEP agreements with contractors and suppliers were either competitively bid or through agreements entered into using market-based rates based on a recent competitive sourcing event)); and used a reasonable amount of company and contractor resources.

End of SL-35-20-N Replacement Project

Pipeline Safety Enhancement Plan Workpaper Supporting Chapter III
SUPPLY LINE 36-37 REPLACEMENT PROJECT

Summary

Table 1: SL-36-37 Replacement Project Summary

Project Name	SL-36-37 Replacement Project
WOA Number / Date	82029 / September 3, 2013
City	Ventura
Original Pipe Diameter/New Diameter	██████████
Construction Start / Finish	April 24, 2014 / June 24, 2014
Loaded Capital Costs	\$1,202,276
Loaded O&M Costs	\$ 0
Total Loaded Project Costs	\$1,202,276
Disallowance	\$ 2,040 (Capital)

Description

Through the SL-36-37 Replacement Project, SoCalGas and SDG&E enhanced its high-pressure transmission pipeline system by upgrading and replacing a total of 63 feet of high-pressure transmission pipe as shown in Figures 1 and 2 and Table 2 that describe the project scope as submitted in the 2011 PSEP filing and the final mileage.

Example of cost avoidance actions included:

- Through scope validation efforts, SoCalGas and SDG&E reduced Category 4 scope mileage by over 100 feet.

Construction began in April 2014 and was completed in June 2014. The SL-36-37 Replacement Project incurred a total loaded project cost of \$1,202,276.

Pipeline Safety Enhancement Plan Workpaper Supporting Chapter III
SUPPLY LINE 36-37 REPLACEMENT PROJECT

Table 2: SL-36-37 Replacement Project 2011 PSEP Filing and Final Mileage*

Line 36-37	Total Mileage	Criteria Mileage	Accelerated Mileage**	Incidental Mileage
2011 PSEP Filing	0.022 mi	0.022 mi	0	0
Final Project Mileage	62 ft.	6 ft.	7 ft.	49 ft.

* Values may not add to total due to rounding.

**Accelerated mileage includes Phase 1B and Phase 2 pipe. Phase 2 includes pipelines without sufficient record of a pressure test in less populated areas (Phase 2A) or pipelines with record of a pressure test, but without record of a pressure test to modern – Subpart J – standards (Phase 2B). Included in this project was 7 feet of pipe accelerated from Phase 1B. The accelerated mileage was included to realize efficiencies and to enhance project constructability.

Pipeline Safety Enhancement Plan Workpaper Supporting Chapter III
SUPPLY LINE 36-37 REPLACEMENT PROJECT

Figure 1: Overview Map of SL 36-37 Replacement Project



Figure 2: Satellite Image of SL 36-37 Replacement Project



Pipeline Safety Enhancement Plan Workpaper Supporting Chapter III
SUPPLY LINE 36-37 REPLACEMENT PROJECT

Stages 1 and 2 – Project Initiation, Analysis and Findings

In workpapers supporting the 2011 PSEP filing,¹ SoCalGas and SDG&E identified the SL-36-37 project as a Phase 1A replacement project. It comprised approximately 0.022 (116 feet) Category 4 Criteria miles in the city of Ventura.

The PSEP Organization was not yet fully up and running at the initiation of this project; therefore, this project was planned and executed by the SoCalGas Distribution Organization with PSEP oversight. This project implemented a modified stage gate review process instead of the formal PSEP Seven Stage Review Process.

Scope validation efforts reduced the scope to 55 feet (6 feet of Category 4 Criteria pipe and 49 feet of incidental pipe). The 6 feet identified for replacement consisted of two sets of reducers and pipe pieces on either side of the remaining 49 feet of incidental pipe.

Engineering Factors

Based on the PSEP Decision Tree, SoCalGas and SDG&E confirmed that the project design should remain a replacement because the scope was less than 1,000 feet. The PSEP Decision Tree directs that scopes less than 1,000 feet should be replaced because, under most circumstances, replacements will be the cost effective option. In this instance no conditions justified overriding this guidance.

¹ See December 2, 2011 Amended Pipeline Safety Enhancement Plan (PSEP) of SoCalGas and SDG&E.

Pipeline Safety Enhancement Plan Workpaper Supporting Chapter III
SUPPLY LINE 36-37 REPLACEMENT PROJECT

Stages 3 and 4 – Initial Planning, Detailed Engineering Design and Procurement

During Stages 3 and 4, SoCalGas and SDG&E completed detailed engineering design work and contractor selection. The SoCalGas Distribution Organization designed and managed the project. The material requirements and the project cost estimate were determined by the planner representing the operating district.

Planning and Design Activity

The project team planned to use in the design a manufactured [REDACTED] reducer with a longer [REDACTED] pipe piece to enable tie-in to the existing [REDACTED] pipeline. This method would allow new pipe and fittings to be installed and tested.

The planned shutdown of this pipeline would use an existing valve at the intersection of Victoria Avenue and Telephone Road and a new pressure-control fitting that was to be installed at the intersection of Main Street and Telephone Road. The installation of the new pressure control fitting and use of an existing main line valve limited the shut-down length of pipeline and prevented gas supply interruptions to customers.

Additional Considerations

- The project would be managed by the SoCalGas Distribution Organization.
- Plan for replacement of 55 feet of [REDACTED] pipe.
- Plan for one mobilization and one demobilization.
- Assume day work for construction activities and night work for tie-in.

Estimate of Costs

The estimated total loaded cost for the 55-foot replacement project was \$1,166,570 as shown in Table 3 and is based on preliminary designs. This estimate was prepared in September 2013 using the SoCalGas Distribution Operating Regions' Construction Management System (CMS).

Pipeline Safety Enhancement Plan Workpaper Supporting Chapter III
SUPPLY LINE 36-37 REPLACEMENT PROJECT

Table 3: SL-36-37 Phase 2 WOA Estimate

Cost Category	Phase 2 WOA
Company Labor Costs	\$78,621
Contract Costs	\$536,189
Material Costs	\$47,101
Other Direct Costs	\$117,688
Total Direct Costs	\$779,599
Total Indirect Costs	\$386,970
Total Loaded Costs	\$1,166,570

Construction Contractor Selection

The SoCalGas Distribution Organization competitively bid this project.

The Construction Contractor’s quoted estimate of work was \$ [REDACTED], which is \$ [REDACTED] more than the CMS direct estimate of \$ [REDACTED] which was used to develop the Phase 2 WOA.

Pipeline Safety Enhancement Plan Workpaper Supporting Chapter III
SUPPLY LINE 36-37 REPLACEMENT PROJECT

Stage 5 - Construction

Schedule

Construction Start Date: 04/24/14

NOP Date: 06/11/14

Construction Finish Date: 06/24/14

Field Conditions

Upon excavation a potential safety condition was discovered that had to be immediately addressed (an immediate repair condition, as defined in CFR §192.933, was identified in the existing [REDACTED] pipeline). The condition was not anticipated during design and planning and impacted the project scope and schedule. The repair condition was an existing 2-inch by 2-inch dent located approximately 2 feet, 10 inches past the proposed east tie-in location. In response, SoCalGas immediately reduced the line pressure in accordance with CFR §192.933(a)(1) and extended the replacement project an additional three feet to remove the damaged portion of the pipe. This activity (deployment of a crew to reduce the pressure and perform the blowdown) added additional costs to the project.

Additionally, because a pipeline anomaly had been discovered, a direct assessment of the pipeline segment needed to be performed. Included in this assessment was a coating inspection, a measure of pipe characteristics, a corrosion assessment, and NDE. As a result of the discovery, the project lasted two weeks longer than planned.

Pipeline Safety Enhancement Plan Workpaper Supporting Chapter III
SUPPLY LINE 36-37 REPLACEMENT PROJECT

Stages 6 and 7 – Commissioning and Closeout

Commissioning activities included site restoration, final inspections, and placement of the pipeline back into service, transportation and disposal of the hydrotested water or hazardous materials and demobilization from the site. Close out activities included development of final drawings, the reconciliation package and updates to company systems to reflect the changes made to the system.

Cost Variance

Table 4: SL-36-37 Replacement Project Phase 2 WOA Estimate and Actual Costs

COST SUMMARY				
	PHASE 2 WOA	CAPITAL (actuals)	DELTA over/(under)	
COMPANY LABOR	\$ 78,621	\$ 149,198	\$	70,577
CONTRACT COSTS	\$ 536,189	\$ 576,343	\$	40,154
MATERIALS	\$ 47,101	\$ 53,463	\$	6,362
OTHER DIRECTS	\$ 117,688	\$ 263,638	\$	145,950
INDIRECTS	\$ 386,971	\$ 159,634	\$	(227,337)
TOTAL LOADED	\$ 1,166,570	\$ 1,202,276	\$	35,706

Table 4 compares the Phase 2 WOA estimate and the March 2016 total loaded actual costs, which exceeded the WOA estimate by \$35,706. An estimate was calculated in Stage 3 using the CMS Estimate Tool.

The above variance is attributable to scope changes and unanticipated conditions that occurred after the Phase 2 WOA estimate (including: identification and addressing an immediate repair condition on the pipe) and underestimating of project support costs. These increased costs were reasonably incurred to complete the replacement work, but were not accounted for in the Stage 3 estimate

Disallowances

For this replacement project, SoCalGas and SDG&E have identified pipe as being installed post 1961 and lacking a pressure test record that provides the minimum information to demonstrate compliance with industry standards or regulatory strength testing and recordkeeping

Pipeline Safety Enhancement Plan Workpaper Supporting Chapter III
SUPPLY LINE 36-37 REPLACEMENT PROJECT

requirements then applicable. Of the pipeline that was replaced, 6 feet of Phase 1A pipe are disallowed. Therefore, a \$2,040 reduction was made to ratebase calculated by determining the replacement mileage and multiplying the amount by \$1.7 million per mile, which is SoCalGas' and SDG&E's system average cost of pressure testing.

Pipeline Safety Enhancement Plan Workpaper Supporting Chapter III
SUPPLY LINE 36-37 REPLACEMENT PROJECT

Conclusion

SoCalGas and SDG&E enhanced the safety of their natural gas system by prudently executing the SL-36-37 Replacement Project. Through this replacement project, SoCalGas and SDG&E successfully replaced 63 feet of predominantly [REDACTED] high pressure transmission pipe in the city of Ventura. The project incurred a total loaded project cost of \$1,202,276.

SoCalGas and SDG&E executed this project prudently: minimizing customer impacts; replacing the pipe using SoCalGas' Distribution Organization so as to complete the safety enhancement work as soon as practicable; and responding to an immediate repair condition by repairing and assessing the pipeline segment.

SoCalGas and SDG&E's total loaded project cost of \$1,202,276 is reasonable and should be approved (minus acknowledged disallowances). SoCalGas and SDG&E engaged in prudent cost avoidance efforts (decreasing project scope through scope validation); engaged in reasonable efforts to promote competitive and market-based rates for contractor services and materials (see Chapter II (Phillips) (approximately 98% of PSEP agreements with contractors and suppliers were either competitively bid or through agreements entered into using market-based rates based on a recent competitive sourcing event)); and used a reasonable amount of company and contractor resources given the complex scope of work (work in a city street with some night work required) and scope changes (identification of an immediate repair condition).

End of SL-36-37 Replacement Project Workpaper

Pipeline Safety Enhancement Program Workpaper Supporting Chapter III
SUPPLY LINE 36-9-09-N 2b HYDROTEST PROJECT

Summary

Table 1: Summary of SL-36-9-09-N 2b Hydrotest Project

Project Name	SL-36-9-09-N 2b Hydrotest Project
WOA Number / Date	25957 / June 2, 2014
City	San Luis Obispo
Original Pipe Diameter/New Pipe Diameter	██████████
Construction Start / Finish	June 23, 2014 / August 14, 2014
Loaded Capital Costs	\$ 0
Loaded O&M Costs	\$ <u>3,146,489</u> <u>2,566,211</u>
Total Loaded Project Costs	\$ <u>3,146,489</u> <u>2,566,211</u>
Disallowance	\$ 0

Background

The SL-36-9-09-N 2b Hydrotest Project is a component of SL-36-9-09-N, which was identified in the 2011 PSEP filing¹ as a 16.016-mile replacement project. The pipeline is located in the cities of Atascadero, San Luis Obispo, Pismo Beach, and Arroyo Grande.

For project manageability purposes and due to unique characteristics related to different portions of the pipeline, SoCalGas and SDG&E divided SL-36-9-09-N into several sections to be project managed individually.

Two key reasons drove the decision to manage the work on SL-36-9-09-N in this manner:

- The sections were physically separated from each other.
- Remediation methods (hydrotesting or replacement) differed among the sections which led to differing permitting timelines.

¹See Amended December 2, 2011 Pipeline Safety Enhancement Plan (PSEP) of SoCalGas and SDG&E.

Pipeline Safety Enhancement Program Workpaper Supporting Chapter III

SUPPLY LINE 36-9-09-N 2b HYDROTEST PROJECT

This workpaper presents the cost information for the SL-36-9-09-N 2b Hydrotest Project.

Description

Through the SL-36-9-09-N 2b Hydrotest Project, SoCalGas and SDG&E enhanced its pipeline system by successfully pressure testing 2.155 miles of high-pressure, [REDACTED] diameter pipe in the city of San Luis Obispo, as shown in Figures 1 and 2 and Table 2 that describe the project scope as of the 2011 PSEP filing date and the final mileage.

Examples of cost avoidance actions included:

- The hydrotest was designed and executed as one continuous test rather than two separate tests on either side of incidental pipe (for the marginal cost of the water). This effort minimized community impacts and avoided costs otherwise associated with a separate mobilization/demobilization and related hydrotest activities for the second location.
- The project used less expensive non-potable water which also had the added benefit of using non-potable water during a time of drought.
- SoCalGas installed approximately 80 feet of permanent pipe as a pre-installation for a future PSEP project in a later phase. This design:
 - Facilitated the current hydrotest, eliminated the need for the replacement of a valve, and avoided impacting customers; and
 - Realized efficiencies by pre-installing replacement pipe that would be needed in the future replacement project (Section 2a) that would follow during a later time.

Construction began in June 2014 and was completed in August 2014. The SL-36-9-09-N 2b Project incurred a total loaded project cost of \$~~3,146,489~~2,566,211.

Pipeline Safety Enhancement Program Workpaper Supporting Chapter III
SUPPLY LINE 36-9-09-N 2b HYDROTEST PROJECT

Table 2: SL-36-9-09-N 2b PSEP Filing and Final Mileage*

Line 36-9-09-N Section 2b	Total Mileage	Criteria Mileage	Accelerated Mileage	Incidental Mileage
2011 Filing (All Sections)	16.016	9.662	6.354	0
Total	2.155	1.990	0	0.165

**Values may not add to total due to rounding.*

Pipeline Safety Enhancement Program Workpaper Supporting Chapter III
SUPPLY LINE 36-9-09-N 2b HYDROTEST PROJECT

Figure 1: Overview Map of SL-36-9-09-N 2b Hydrotest Project



Figure 2: Satellite Image of SL-36-9-09-N 2b Hydrotest Project



Pipeline Safety Enhancement Program Workpaper Supporting Chapter III
SUPPLY LINE 36-9-09-N 2b HYDROTEST PROJECT

Stage 1 – Project Initiation

In the workpapers supporting the 2011 PSEP filing, SoCalGas and SDG&E identified the SL-36-9-09-N Project as a Phase 1A replacement project. It comprised approximately 9.662 Category 4 Criteria miles and 6.354 accelerated miles and is located in the cities of Atascadero, San Luis Obispo, Pismo Beach, and Arroyo Grande.

During Stage 1, SoCalGas and SDG&E completed scope validation confirming that the majority of SL-36-9-09-N was first installed in 1920 (SL-36-9-09-N 2b was installed in 1953) and determined that the overall project scope had increased. The reason for this increase was due to portions of the pipeline that had been reclassified from Class 2 to Class 3 between the PSEP filing and the Stage 1 review. This change resulted in an increase in the Criteria mileage by 6.248 miles, a decrease in accelerated mileage by 5.804 miles, and an increase in incidental mileage by 1.710 miles

Pipeline Safety Enhancement Program Workpaper Supporting Chapter III

SUPPLY LINE 36-9-09-N 2b HYDROTEST PROJECT

Stage 2 – Analysis and Findings

During Stage 2, data analysis was performed and the findings were used to define project scope and to plan tasks for later stages of the SL-36-9-09-N 2b project.

Through scope validation the mileage of SL-36-9-09-N 2b was determined to be 2.165 total miles, consisting of approximately 2 Criteria miles and 0.165 incidental miles.

Engineering Factors

SoCalGas and SDG&E performed a TVR analysis and a PSEP Decision Tree analysis of SL-36-9-09-N 2b, which indicated that a hydrotest of SL-36-9-09-N 2b should be conducted instead of replacement because:

- The pipeline can be removed from service for a pressure test with minimal to no impact to customers.
- Major changes were not needed to make the line piggable, with exception of two non-piggable fittings.
- No known anomalies or instances of leaks were identified in a review of leak history.
- There were no significant engineering factors that caused SoCalGas and SDG&E to consider replacement.

The 0.165 incidental miles included in the project were used to connect two Category 4 pipe segments to facilitate a single hydrotest (see Figure 1). This use of incidental mileage added no appreciable cost, but reduced overall project costs.

Pipeline Safety Enhancement Program Workpaper Supporting Chapter III

SUPPLY LINE 36-9-09-N 2b HYDROTEST PROJECT

Stage 3 – Initial Planning and Design

During Stage 3, SoCalGas and SDG&E developed a Phase 2 WOA estimate, and began field surveys to complete preliminary design drawings and further refine the scope. Preliminary drawings were also used to initiate procurement of long lead materials.

In addition to the schedule and estimate, other key activities include identifying all permits, TREs, and easements, defining long lead materials and pricing, understanding customer impacts and interruptions, and preparing any necessary environmental submittals.

Planning and Design Activity

The initial engineering design for SL-36-9-09-N 2b included:

- Remove [REDACTED] pressure control fitting at the south end because it lacked the pressure rating to withstand a hydrotest and was not a piggable fitting.
- Remove [REDACTED] pressure control fitting in the middle because it lacked the pressure rating to withstand a hydrotest and was not a piggable fitting.
- Remove blow off valve located at the north end because it lacked the pressure rating to withstand a hydrotest.

Additional Considerations

- Plan for one mobilization and demobilization.
- Three bell holes for two test heads and one fitting removal would be required.
 - The bell hole location of the northern test head was in a parking lot along Miossi Rd.
 - The bell hole location of the southern test head was south of the intersection of Roundhouse St. and Emily St.
 - The bell hole location of the fitting removal was east of the intersection of San Luis Dr. and Corralitos Ave.
- In consideration of the drought, plan to use non-potable water.

Pipeline Safety Enhancement Program Workpaper Supporting Chapter III
SUPPLY LINE 36-9-09-N 2b HYDROTEST PROJECT

- Adjust the tie-in location of a future replacement project (see Figure 3) to avoid an environmentally sensitive area with indigenous Serpentine rock (containing naturally occurring asbestos). As a result, 42 feet of Criteria pipe was reduced from the scope of Section 2b and will be addressed in the 2a project.

Cost Avoidance

- The hydrotest was designed and executed as one continuous test rather than two separate tests on either side of incidental pipe (for the marginal cost of the water). This effort minimized community impacts and avoided costs otherwise associated with a separate mobilization/demobilization and related hydrotest activities for the second location.

Estimate of Costs

The estimated total loaded cost for the 36-9-09-N 2b Hydrotest Project was \$2,168,871, as shown in Table 3, and is based on preliminary designs. This estimate was prepared in March 2014 using the Stage 3 SCG Pipeline Estimate Template Rev 0 tool.

Table 3: SL-36-9-09N-2b Hydrotest Project Phase 2 WOA Estimate

Cost Category	Phase 2 WOA
Company Labor Costs	\$ 199,702
Contract Costs	\$ 1,558,410
Material Costs	\$ 88,958
Other Direct Costs	\$ 41,855
Total Direct Costs	\$ 1,888,925
Total Indirect Costs	\$ 279,946
Total Loaded Costs	\$ 2,168,871

Pipeline Safety Enhancement Program Workpaper Supporting Chapter III
SUPPLY LINE 36-9-09-N 2b HYDROTEST PROJECT

Stage 4 – Detailed Planning Design and Procurement

During Stage 4, detailed design and material procurement was completed in order to provide a construction ready packet to construction contractor to execute the planned project scope. The following scope changes occurred during this stage:

- The location for the northern test head was moved approximately 80 feet northwest to avoid blocking the parking facilities at a veterinarian clinic. The revised design eliminated the need for the replacement of a valve. The redesign would also further facilitate the future construction and tie-in activity of the SL-36-9-09-N 2a replacement project to be constructed at a later time (see Figure 3).
- The location of the southern test head and supporting equipment (such as Baker Tanks and pumps) were relocated across the street to avoid obstruction of the ingress and egress at the San Luis Obispo Fire Department.

Figure 3: Satellite Map of Future Tie-In between SL-36-9-09-N 2b and SL-36-9-09-N 2a



Pipeline Safety Enhancement Program Workpaper Supporting Chapter III
SUPPLY LINE 36-9-09-N 2b HYDROTEST PROJECT

Construction Contractor Selection

Construction of the SL-36-9-09-N 2b Hydrotest Project utilized the PSEP Performance Partnership Program and the construction contract was awarded to the Performance Partner selected for this geographic area.

The Performance Partner/Construction Contractor's TPE was [REDACTED], which is [REDACTED] more than the Stage 3 Construction Contractor direct estimate of [REDACTED] that was used to develop the Phase 2 WOA estimate.

Pipeline Safety Enhancement Program Workpaper Supporting Chapter III
SUPPLY LINE 36-9-09-N 2b HYDROTEST PROJECT

Stage 5 – Construction

Schedule

Construction Start Date: 06/23/2014

NOP Date: 07/31/2014

Construction Finish Date: 08/14/2014

Construction delays due to the field conditions discussed below contributed to the approximate 20-day delay from the preliminary construction schedule as well as increased costs.

Field Conditions

Conditions were encountered in the field that were not anticipated during design and planning that had to be addressed or mitigated. Listed below is a summary of the key field changes broken down by type of change for this project:

Leak Condition:

- The construction team identified a minor leak on the pipeline while removing a pressure control fitting in order to complete the hydrotest. The team reacted in a safe manner to contain the leak by placing a temporary clamp over the leak. The team then removed the pipe where the leak had been identified along with the pressure control fitting and replaced the segment with new pipe.

Permits:

- The northern blow off valve that was identified for removal was on Caltrans property. A Caltrans permit was requested to gain access to the valve for removal.

Pipeline Safety Enhancement Program Workpaper Supporting Chapter III
SUPPLY LINE 36-9-09-N 2b HYDROTEST PROJECT

Constructability Issue:

- Additional pressure control fittings not in the original scope of work were added to safely perform gas handling.

Pipeline Safety Enhancement Program Workpaper Supporting Chapter III
SUPPLY LINE 36-9-09-N 2b HYDROTEST PROJECT

Stages 6 and 7 – Commissioning and Closeout

Commissioning activities included site restoration, final inspections, and placement of the pipeline back into service, transportation and disposal of the hydrotested water or hazardous material and demobilization from the site. Close out activities included development of final drawings, the reconciliation package and updates to company systems to reflect the changes made to the system.

Cost Variance

Table 4: SL-36-9-09-N 2b Hydrotest Project Phase 2 WOA Estimate and Actual Costs

(Revised)

COST SUMMARY				
	PHASE 2 WOA	O&M	Delta Over/(under)	
COMPANY LABOR	\$ 199,702	\$ 127,448	\$	(72,254)
CONTRACT COSTS	\$ 1,558,410	\$ 1,687,986	\$	129,576
MATERIALS	\$ 88,958	\$ 34,870	\$	(54,088)
OTHER DIRECTS	\$ 41,855	\$ 1,099,506	\$	1,057,651
OTHER DIRECTS		\$ 555,180	\$	513,325
INDIRECTS	\$ 279,946	\$ 196,679	\$	(83,267)
INDIRECTS		\$ 160,727	\$	(119,219)
TOTAL	\$ 2,168,871	\$ 3,146,489	\$	977,618
TOTAL		\$ 2,566,211	\$	397,340

Table 4 compares the preliminary Phase 2 WOA estimate and the March 2016 loaded actual. The loaded actual costs exceeded the Phase 2 WOA estimate by ~~\$977,618~~ \$397,340.

The above variance is attributable to scope changes and unanticipated conditions that occurred after the Phase 2 WOA estimate (including: relocating the northern test head to avoid impacting a veterinarian clinic and facilitate future PSEP work; relocation of the southern test head to avoid obstructing the San Luis Obispo Fire Department; identification of a leak and associated response; installation of additional pressure control fittings; and procurement of Caltrans permit to remove a blow off valve); and an early cost estimating tool and process that was based on preliminary project designs (resulting in underestimation of construction contractor costs, water

Pipeline Safety Enhancement Program Workpaper Supporting Chapter III
SUPPLY LINE 36-9-09-N 2b HYDROTEST PROJECT

management, inspection, engineering, and other project support costs). These increased costs were reasonably incurred to complete the hydrotest, but were not accounted for in the Stage 3 estimate.

Disallowances

There was no disallowance for the SL 36-9-09-N 2b Hydrotest Project as there were no post-1955 segments included in the project without records that provide the minimum information to demonstrate compliance with industry standards or regulatory strength testing and recordkeeping requirements then applicable.

Pipeline Safety Enhancement Program Workpaper Supporting Chapter III
SUPPLY LINE 36-9-09-N 2b HYDROTEST PROJECT

Conclusion

SoCalGas and SDG&E enhanced the safety of their natural gas system by prudently executing the SL 36-9-09-N 2b Hydrotest Project. Through this hydrotest project, SoCalGas and SDG&E successfully hydrotested 2.154 miles of high-pressure [REDACTED] diameter pipe in the city of San Luis Obispo. The project incurred a total loaded project cost of \$3,146,4892,566.211.

SoCalGas and SDG&E executed this project prudently: engaging in prudent cost avoidance efforts; minimizing impacts to customers and the community; designing the project to facilitate future PSEP projects; designing the project to minimize community impacts; and responding to unknown field conditions.

SoCalGas and SDG&E's total loaded project cost of \$3,146,4892,566.211 is reasonable and should be approved. SoCalGas and SDG&E engaged in prudent cost avoidance efforts (adding incidental mileage to the project to hydrotest one continuous test rather than incurring costs associated with two separate tests; designing the project to facilitate future PSEP projects cost effectively; and using non-potable water); engaged in reasonable efforts to promote competitive and market-based rates for contractor services and materials (see Chapter II (Phillips) (approximately 98% of PSEP agreements with contractors and suppliers were either competitively bid or through agreements entered into using market-based rates based on a recent competitive sourcing event)); and used a reasonable amount of company and contractor resources given the project's complexity (an over two-mile hydrotest in populated areas) and work scope changes (expanded scope to address a leak, need for a Caltrans permit, installation of pipe to avoid impacting the community and facilitate future PSEP work, and installation of additional pressure control fittings not anticipated in the original scope of work).

End of SL-36-9-09-N 2b Hydrotest Project Workpaper

Pipeline Safety Enhancement Plan Workpaper Supporting Chapter III
SUPPLY LINE 36-9-09-N 6a HYDROTEST PROJECT

Summary

Table 1: SL-36-9-09-N 6a Hydrotest Project

Project Name	SL-36-9-09-N 6a Hydrotest Project
WOA Number / Date	25961 / June 2, 2014
City	Arroyo Grande
Original Pipe Diameter/ New Pipe Diameter	██████████
Construction Start / Finish	March 16, 2015 / May 20, 2015
Loaded Capital Costs	\$ 0
Loaded O&M Costs	\$2,785,427
Total Loaded Project Costs	\$2,785,427
Disallowance	\$ 0

Background

SL-36-9-09-N was identified in the 2011 PSEP filing¹ as a 16.016-mile replacement project. This supply line runs through the cities of Atascadero, San Luis Obispo, Pismo Beach, and Arroyo Grande.

For project manageability purposes and due to unique characteristics related to different portions of the pipeline, SoCalGas and SDG&E divided SL-36-9-09-N into several sections to be project managed individually. Two key reasons drove the decision to manage the work on SL-36-9-09-N in this manner:

- The sections were physically separated from each other.
- Remediation methods (hydrotesting or replacement) differed among the sections, which led to differing permit acquisition timelines.

¹See December 2, 2011 Amended Pipeline Safety Enhancement Plan (PSEP) of SoCalGas and SDG&E.

Pipeline Safety Enhancement Plan Workpaper Supporting Chapter III

SUPPLY LINE 36-9-09-N 6a HYDROTEST PROJECT

This workpaper presents the cost information for the SL-36-9-09-N 6a Hydrotest Project. Originally a single project, it was later split into sections 6a and 6b. This occurred due to complications with the local jurisdiction over the replacement portion's (section 6b) routing impacts. SL-36-9-09-N 6b will be submitted in a workpaper associated with a future reasonableness review application.

Description

Through the SL-36-9-09-N 6a Project, SoCalGas and SDG&E enhanced their pipeline system by successfully hydrotesting 0.916 miles of high-pressure, [REDACTED] diameter pipe in the city of Arroyo Grande, as shown in Figures 1 and 2 and Table 2 that describe the project scope as of the 2011 PSEP filing date and the final mileage.

Examples of cost avoidance actions included:

- A single hydrotest was designed to encompass three separate Category 4 segments, which minimized community/customer impacts and avoided costs otherwise associated with multiple mobilizations/demobilizations.
- Test head points were located in spaces that minimized construction and traffic control complications, which reduced costs and impacts to the community.

Construction began in March 2015 and was completed in May 2015. The SL-36-9-09-N 6a Project incurred a total loaded project cost of \$2,785,427.

Pipeline Safety Enhancement Plan Workpaper Supporting Chapter III
SUPPLY LINE 36-9-09-N 6a HYDROTEST PROJECT

Table 2: SL-36-9-09-N 6a PSEP Filing and Final Mileage*

Line 36-9-09-N Section 6a	Total Mileage	Criteria Mileage	Accelerated Mileage	Incidental Mileage
2011 Filing (All Sections)	16.016	9.662	6.354	0
Total	0.916	0.389	0	0.527

**Values may not add to total due to rounding.*

Pipeline Safety Enhancement Plan Workpaper Supporting Chapter III
SUPPLY LINE 36-9-09-N 6a HYDROTEST PROJECT

Figure 1: Overview Map of SL-36-9-09-N 6a Hydrotest Project



Figure 2: Satellite Image of SL-36-9-09-N 6a Hydrotest Project



Pipeline Safety Enhancement Plan Workpaper Supporting Chapter III
SUPPLY LINE 36-9-09-N 6a HYDROTEST PROJECT

Stage 1 – Project Initiation

In the workpapers supporting the 2011 PSEP filing, SoCalGas and SDG&E identified the SL-36-9-09-N Project as a Phase 1A replacement project. It comprised approximately 9.662 Category 4 Criteria miles and 6.354 accelerated miles, and is located in the cities of Atascadero, San Luis Obispo, Pismo Beach, and Arroyo Grande.

During Stage 1, SoCalGas and SDG&E completed scope validation confirming that the majority of SL 36-9-09-N was first installed in 1920 (SL 36-9-09-N 6a was installed in 1954) and determined that the overall project scope had increased. The reason for this increase was due to portions of the pipeline that had been reclassified from Class 2 to Class 3 between the PSEP filing and the Stage 1 review. This change resulted in an increase in the Criteria mileage by 6.248 miles, a decrease in accelerated mileage by 5.804 miles, and an increase in incidental mileage by 1.710 miles.

Pipeline Safety Enhancement Plan Workpaper Supporting Chapter III
SUPPLY LINE 36-9-09-N 6a HYDROTEST PROJECT

Stage 2 – Analysis and Findings

During Stage 2, data analysis was performed and the findings were used to define project scope and to plan tasks for later stages of the SL-36-9-09-N Section 6 Project. The scope of SL-36-9-09-N Section 6 was determined to be 1.230 total miles which consisted of 0.998 Criteria miles and 0.232 incidental miles.

Engineering Factors

The portion of the line that was later characterized as Section 6a was designated a hydrotest because:

- The pipeline can be removed from service for a pressure test with minimal to no impact to customers.
- Major changes were not needed to make the line piggable, with exception one unpiggable fitting at an elbow at the southeast end of the hydrotest. This fitting would require replacement.
- No known anomalies or instances of leaks were identified in a review of leak history.
- There were no other engineering factors that warranted replacement.

The 0.232 incidental included in the project were used to facilitate the hydrotest activities by connecting three Category 4 pipe segments to perform one hydrotest (see Figure 1) which improved constructability and realized efficiencies.

The portion of the line that was later characterized as Section 6b was designated a replacement because:

- A small portion of the pipeline was installed in 1932.
- The pipeline had varying diameters of pipe ([REDACTED]). These differing diameters made the line unpiggable.
- The PSEP Decision Tree indicated that pre-1946, non-piggable gas transmission pipe should be replaced.

Pipeline Safety Enhancement Plan Workpaper Supporting Chapter III
SUPPLY LINE 36-9-09-N 6a HYDROTEST PROJECT

Stage 3 – Initial Planning and Design

During Stage 3, SoCalGas and SDG&E developed a Phase 2 WOA estimate and began field surveys to complete preliminary design drawings and further refine the scope. Preliminary drawings were also used to initiate procurement of long lead materials.

In addition to the schedule and estimate, other key activities include identifying all permits, TREs, and easements, defining long lead materials and pricing, understanding customer impacts and interruptions, and preparing any necessary environmental submittals.

Planning and Design Activity

The initial planning and design for SL-36-9-09-N Section 6 (before it was split into sections 6a and 6b) included:

- A single post construction strength test of the replaced segment (Section 6b) tied to the segment of existing pipe (Section 6a).
- Use of the existing [REDACTED] gas pipeline under Highway 101 as casing for the new [REDACTED] replacement pipeline (ultimately on Section 6b).
- Use of the open-trench method to replace the pipeline. A jack-and-bore method would be used where the pipeline passes under Grand Ave (Highway 227) (ultimately on Section 6b).

Additional Considerations

- Plan for a single mobilization and a single demobilization for Section 6.

During Stage 3, the planned tie-in locations were increased to minimize local traffic impacts to Caltrans on/off ramps.

Cost Avoidance

- To minimize construction complications due to Caltrans traffic control requirements, the test head points were located in spaces that would reduce the overall costs and impacts to the community.

Pipeline Safety Enhancement Plan Workpaper Supporting Chapter III
SUPPLY LINE 36-9-09-N 6a HYDROTEST PROJECT

Estimate of Costs

Table 3 shows the estimated total loaded cost based on the preliminary design. This estimate was prepared in June 2014 using the Stage 3 SCG Pipeline Estimate Template Rev 0 tool.

As previously discussed and shown below, the planning, design and cost assumptions that underlie the Phase 2 WOA estimate pertain to the combined SL-36-9-09-N 6a O&M (hydrotest) and SL-36-9-09-N 6b Capital (replacement) forecasted costs. Note: the O&M cost estimate is for the hydrotest project (6a) and the capital costs estimate is for the replacement project (6b).

Table 3: SL-36-9-09-N 6a & 6b Phase 2 WOA Estimate

Cost Category	Capital	O&M	Estimate Total
Company Labor Costs	\$368,972	\$40,997	\$409,969
Contract Costs	\$4,806,061	\$1,219,503	\$6,025,563
Materials Costs	\$217,510	\$25,998	\$243,508
Other Direct Costs	\$185,582	\$74,882	\$260,463
Total Direct Costs	\$5,578,125	\$1,361,379	\$6,939,503
Total Indirect Costs	\$799,805	\$94,087	\$893,892
Total Loaded Costs	\$6,377,929	\$1,455,466	\$7,833,395

Pipeline Safety Enhancement Plan Workpaper Supporting Chapter III
SUPPLY LINE 36-9-09-N 6a HYDROTEST PROJECT

Stage 4 – Detailed Engineering Design and Procurement

During Stage 4, SoCalGas and SDG&E completed detailed planning design work and determined that Section 6 needed to be split into two sections – 6a and 6b. The reasons for the split were because the two sections varied in type (one is a hydrotest and the other a replacement) and schedule. Specifically, the replacement section (6b) had design and routing options that involved additional discussions with the affected local jurisdiction due to greater impact on traffic flow. As such, section 6b will be submitted in a separate workpaper to the CPUC in a future reasonableness review application.

In Stage 4, the scope of SL-36-9-09-N 6a was confirmed to be a total of 0.916 total miles, with 0.389 miles identified as Criteria and 0.527 miles identified as incidental miles.

Detailed Planning and Design

During Stage 4, the following were assumed for SL-36-9-09-N 6a:

- Use existing pressure control fitting to isolate the line for testing.
- Modify test head assumptions to add a new test head to Section 6a to facilitate the hydrotest of just this section.
- Plan for one mobilization and one demobilization.

Cost Avoidance

- In the area later designated as 6a there were three separate segments that required hydrotesting. Rather than conduct three separate hydrotests (each with the requisite mobilization, bell holes and test heads), cost savings could be realized by combining the three tests into one by including incidental mileage (for the marginal expense of the extra water used).

Pipeline Safety Enhancement Plan Workpaper Supporting Chapter III
SUPPLY LINE 36-9-09-N 6a HYDROTEST PROJECT

Construction Contractor Selection

Construction of the SL-36-9-09-N 6a Hydrotest Project utilized the PSEP Performance Partnership Program and the construction contract was awarded to the Performance Partner selected for this geographic area.

The Performance Partner/Construction Contractor TPE was \$ [REDACTED] which is \$ [REDACTED] more than the Stage 3 Construction Contractor direct estimate of \$ [REDACTED] that was used to develop the Phase 2 WOA estimate.

Pipeline Safety Enhancement Plan Workpaper Supporting Chapter III
SUPPLY LINE 36-9-09-N 6a HYDROTEST PROJECT

Stage 5 – Construction

Schedule

Construction Start Date: 03/16/2015

NOP Date: 05/05/2015

Construction Finish Date: 05/20/2015

Field Conditions

No unanticipated field conditions were encountered.

Pipeline Safety Enhancement Plan Workpaper Supporting Chapter III
SUPPLY LINE 36-9-09-N 6a HYDROTEST PROJECT

Stages 6 and 7 – Commissioning and Closeout

Commissioning activities included site restoration, final inspections and placement of the pipeline back into service, transportation and disposal of the hydrotested water or hazardous materials, and demobilization from the site. Close out activities included development of final drawings, the reconciliation package and updates to company systems to reflect the changes made to the system.

Cost Variance

Table 4: SL-36-9-09-N 6a Hydrotest Project Phase 2 WOA Estimate and Actual Costs

COST SUMMARY				
	PHASE 2 WOA	O&M (actuals)	DELTA over/(under)	
COMPANY LABOR	\$ 40,997	\$ 45,314	\$	4,317
CONTRACT COSTS	\$ 1,219,503	\$ 1,646,454	\$	426,951
MATERIALS	\$ 25,998	\$ 33,882	\$	7,884
OTHER DIRECTS	\$ 74,882	\$ 949,412	\$	874,530
INDIRECTS	\$ 94,087	\$ 110,364	\$	16,277
TOTAL LOADED	\$ 1,455,467	\$ 2,785,427	\$	1,329,960

Table 4 compares the Phase 2 WOA estimate and the March 2016 loaded actual costs. The loaded actual costs were \$1,329,960 more than the Phase 2 WOA estimate. The WOA estimate was calculated using in the Stage 3 SoCalGas Pipeline Estimate Template Rev. 0 for the entire project.

After the split in Stage 4 between 6a (hydrotest) and 6b (replacement), the O&M portion of the combined WOA was assumed to be only associated with the hydrotest (Section 6a) estimated expenses. The capital portion of the combined WOA was assumed to be only associated with the replacement (Section 6b) estimated expenses. Since this workpaper only addresses Section 6a, the above table compares the actuals to the O&M portion of the original Phase 2 WOA estimate.

Pipeline Safety Enhancement Plan Workpaper Supporting Chapter III
SUPPLY LINE 36-9-09-N 6a HYDROTEST PROJECT

The above variance is attributable to an additional test head required to facilitate the hydrotest of just the 6a portion, and to an early cost estimating tool and process that was based on preliminary project designs (resulting in underestimation of construction costs, inspection costs, environmental costs, engineering costs, and other project support costs). These increased costs were reasonably incurred to complete the hydrotest, but were not accounted for in the Stage 3 estimate.

Disallowances

There was no disallowance for the SL-36-9-09-N 6a Hydrotest Project as there were no post-1955 segments included in the project without records that provide the minimum information to demonstrate compliance with industry standards or regulatory strength testing and recordkeeping requirements then applicable.

Pipeline Safety Enhancement Plan Workpaper Supporting Chapter III
SUPPLY LINE 36-9-09-N 6a HYDROTEST PROJECT

Conclusion

SoCalGas and SDG&E enhanced the safety of their natural gas system by prudently executing the SL-36-9-09-N 6a Hydrotest Project. Through this hydrotest project, SoCalGas and SDG&E successfully hydrotested 0.916 miles of high-pressure [REDACTED] diameter pipe in the city of Arroyo Grande. The project incurred a total loaded project cost of \$2,785,427.

SoCalGas and SDG&E executed this project prudently: engaging in prudent cost avoidance efforts; minimizing impacts to customers and the community; and installing fittings to enhance pigability.

SoCalGas and SDG&E's total loaded project cost of \$2,785,427 is reasonable and should be approved. SoCalGas and SDG&E engaged in prudent cost avoidance efforts (including using incidental mileage to enable the hydrotesting to be performed as a single test instead of three separate tests and designing the test head locations to minimize construction and traffic control complications); engaged in reasonable efforts to promote competitive and market-based rates for contractor services and materials (see Chapter II (Phillips) (approximately 98% of PSEP agreements with contractors and suppliers were either competitively bid or through agreements entered into using market-based rates based on a recent competitive sourcing event)); and used a reasonable amount of company and contractor resources given the project's complexity (an almost one mile hydrotest along Highway 101) and work scope changes (the installation of an additional test head).

End of SL-36-9-09-N 6a Hydrotest Project Workpaper

Pipeline Safety Enhancement Plan Workpaper Supporting Chapter III
SUPPLY LINE 36-1032 REPLACEMENT PROJECT

Summary

Table 1: SL-36-1032 Sections 1, 2 and 3 Replacement Project Summary

Project Name	SL-36-1032 Sections 1, 2 and 3 Replacement Project
WOA Number / Date	82022 /December 10, 2013
City	Lompoc
Predominate Pipe Vintage	1928 - 1948
Original Pipe Diameter/New Diameter	██████████
Construction Start / Finish	May 12, 2014 / March 19, 2015
Loaded Capital Costs	\$ 10,953,327
Loaded O&M Costs	\$ 0
Total Loaded Project Costs	\$ 10,953,327
Disallowance	\$ 0

Background

SL-36-1032 is a high-pressure pipeline of primarily ██████ diameter pipe located in Lompoc, California. To better manage the planning and construction efforts, as well as lessen customer impact, the SL-36-1032 project was separated into four sections. This workpaper addresses three non-contiguous replacement sections: Sections 1, 2 and 3. Section 1 was not identified in the 2011 PSEP filing; however, upon completion of a Feature Study in Stage 1 of this project, the HCA criterion indicated that the approximately 440 feet of Category 4 Criteria mileage needed to be added to the PSEP scope. Section 4 is a separate project and will be submitted in a future reasonableness review application.

Description

Through the SL-36-1032 Sections 1, 2 and 3 Replacement Project, SoCalGas and SDG&E enhanced its pipeline system by successfully replacing 0.653 miles of high-pressure, ██████ diameter pipe in the city of Lompoc, as shown in Figures 1 – 8 and Table 2 that describe the project scope as submitted in the 2011 PSEP filing and the final mileage.

Pipeline Safety Enhancement Plan Workpaper Supporting Chapter III
SUPPLY LINE 36-1032 REPLACEMENT PROJECT

Examples of cost avoidance actions included:

- Scope validation resulted in a reduction of Category 4 Criteria mileage from 1.862 miles described in the 2011 PSEP filing to 0.605 miles for all four sections.
- After learning that the City of Lompoc had future plans to widen a road, the pipeline location for Section 2 was moved to the other side of the street to avoid future relocation.
- SoCalGas and SDG&E extended the length of the pipeline replacement by 332 feet to capture Phase 1B footage for efficiency.

Construction began on the SL-36-1032 Sections 1, 2 and 3 Replacement Project in May 2014 and was completed in March 2015. The project incurred a total loaded project cost of \$10,953,327.

Table 2: SL-36-1032 Sections 1, 2 and 3 2011 PSEP Filing and Final Mileage*

Line 36-1032	Total Mileage	Criteria Mileage	Accelerated Mileage**	Incidental Mileage
2011 PSEP Filing (Section 1, 2, 3)	3.095 mi.	1.862 mi.	1.233 mi.	0
Total Project Mileage				
Section 1	535 ft.	249 ft.	263 ft.	23 ft.
Section 2	2,057 ft.	1,076 ft.	332 ft.	649 ft.
Section 3	857 ft.	743 ft.	0	114 ft.
Total	3,448 ft.	2,068 ft.	595 ft.	786 ft.

*Values may not add to total due to rounding.

**Accelerated mileage includes Phase 1B and Phase 2 pipe. Phase 2 includes pipelines without sufficient record of a pressure test in less populated areas (Phase 2A) or pipelines with record of a pressure test, but without record of a pressure test to modern – Subpart J – standards (Phase 2B). Included in this project was 224 feet of pipe accelerated from Phase 1B

Pipeline Safety Enhancement Plan Workpaper Supporting Chapter III
SUPPLY LINE 36-1032 REPLACEMENT PROJECT

and 371 feet of pipe accelerated from Phase 2A. The accelerated mileage was included to realize efficiencies and to enhance project constructability.

Pipeline Safety Enhancement Plan Workpaper Supporting Chapter III
SUPPLY LINE 36-1032 REPLACEMENT PROJECT

Figure 1: Overview Map of SL-36-1032 Sections 1, 2 and 3



Figure 2: Satellite Image of SL-36-1032 Sections 1, 2 and 3



Pipeline Safety Enhancement Plan Workpaper Supporting Chapter III
SUPPLY LINE 36-1032 REPLACEMENT PROJECT

Figure 3: Overview Map of SL-36-1032 Section 1



Figure 4: Satellite Image of SL-36-1032 Section 1



Pipeline Safety Enhancement Plan Workpaper Supporting Chapter III
SUPPLY LINE 36-1032 REPLACEMENT PROJECT

Figure 5: Overview Map of SL-36-1032 Section 2



Figure 6: Satellite Image of SL-36-1032 Section 2



Pipeline Safety Enhancement Plan Workpaper Supporting Chapter III
SUPPLY LINE 36-1032 REPLACEMENT PROJECT

Stage 1 – Project Initiation

In workpapers supporting the 2011 PSEP filing,¹ SoCalGas and SDG&E identified the SL-36-1032 project as 3.095-mile Phase 1A hydrotest and replacement project. It comprised approximately 1.862 Category 4 Criteria miles and 1.233 accelerated miles.

During Stage 1, SoCalGas and SDG&E completed scope validation and confirmed that the majority of SL-36-1032 was first installed in 1928. Scope validation also confirmed that the overall project scope had decreased from the filing. The reason for the change in mileage was primarily due to:

- Upon completion of scope validation, pipe grade and wall thickness data reduced a significant portion of the pipeline below the 20% SMYS threshold of the PSEP program.
- The HCA evaluation based on current area information added footage to the project (Section 1).
- Section 4 was removed from the project due to the need for additional engineering analysis and will be a separate project filed at a later date. This resulted in approximately 500 feet being removed from this project.

¹ See December 2, 2011, Amended Pipeline Safety Enhancement Plan (PSEP) of SoCalGas and SDG&E.

Pipeline Safety Enhancement Plan Workpaper Supporting Chapter III
SUPPLY LINE 36-1032 REPLACEMENT PROJECT

Stage 2 – Analysis and Findings

During Stage 2, data analysis was performed and the findings were used to define project scope and to plan tasks for later stages of the project. As the project engineering and design progressed, alignment changes were made to mitigate customer impact. Accelerated and incidental mileage increased in order to test a continuous section of pipe and to improve constructability and avoid having to return to test at a later date. SoCalGas and SDG&E elected to manage this project in three separate sections due to the distance between the pipe segments.

Section 1

SoCalGas and SDG&E confirmed the scope of Section 1 to be 443 feet of Category 4 Criteria pipe.

Engineering Factors

Based on the PSEP Decision Tree, SoCalGas and SDG&E confirmed that the SL-36-1032 Section 1 project design should commence as a replacement project because the section's scope was less than 1,000 feet. The PSEP Decision Tree directs that scope less than 1,000 feet should be replaced because, under most circumstances, replacements will be the cost effective option. Additionally, the pipe vintage was 1928. In this instance there were no conditions justified overriding this guidance.

Section 2

SoCalGas and SDG&E confirmed the scope of Section 2 to be 1,076 feet of Category 4 Criteria and accelerated pipe.

Engineering Factors

A PSEP Decision Tree analysis of Section 2 indicated that the project would remain a replacement because the pipe vintage was 1928 and the pipe was unpiggable.

Pipeline Safety Enhancement Plan Workpaper Supporting Chapter III

SUPPLY LINE 36-1032 REPLACEMENT PROJECT

Adjacent to the existing 1,076 feet of Category 4 Criteria pipe in Section 2 was 332 feet of Category 4 pipe located in a Class 1 location (accelerated Phase 2 pipe). Rather than returning at a later date to replace this 332 foot section during PSEP Phase 1B, SoCalGas and SDG&E decided to add the 332 feet to Section 2 scope. This increase in scope was done to optimize efficiencies to avoid additional future mobilization, construction and demobilization costs.

Section 3

SoCalGas and SDG&E confirmed the scope of Section 3 to be 743 feet of Category 4 Criteria pipe.

Engineering Factors

Based on the PSEP Decision Tree, SoCalGas and SDG&E confirmed that the SL-36-1032 Section 3 project design should commence as a replacement project because the section's scope was less than 1,000 feet. The PSEP Decision Tree directs that scope less than 1,000 feet should be replaced because, under most circumstances, replacements will be the cost effective option. In this instance there were no conditions justified overriding this guidance. In addition, during review it was noted that the line is not piggable and that a hydrotest would require either CNG/LNG or bypass support for major customers and regulator stations.

Pipeline Safety Enhancement Plan Workpaper Supporting Chapter III

SUPPLY LINE 36-1032 REPLACEMENT PROJECT

Stage 3 – Initial Planning and Design

During Stage 3, SoCalGas and SDG&E developed a Phase 2 WOA estimate, and began field surveys to complete preliminary design drawings and further refined scope.

In addition to the schedule and estimate, other key activities included identifying all permits, TREs, and easements, defining long lead materials and pricing, understanding customer impacts and preparing any necessary environmental submittals.

Section 1

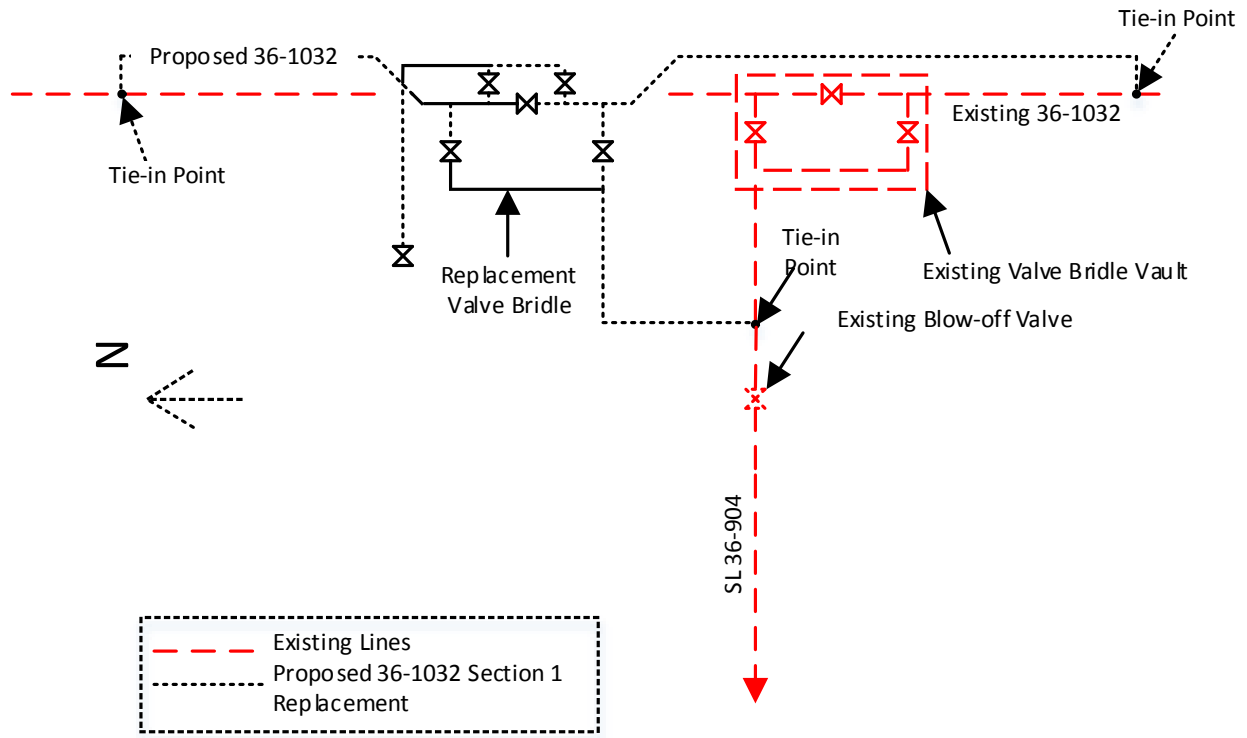
Planning and Design Activity

The initial design for SL-36-1032 Section 1 included (see Figure 9):

- Replace the existing [REDACTED] pipe with [REDACTED] pipe. Install and test the new [REDACTED] line with valve bridle next to the old line. The replaced pipeline would be abandoned in place. The upgraded pipe size was intended to standardize the pipeline to enhance pigging and realize cost efficiencies. (Note: SoCalGas and SDG&E had purchased bulk [REDACTED] pipe).
- Tie the feed line from the valve bridle to SL-36-9-04 upstream of the blow-off valve.
- The existing valve bridle and vault would be removed. The new valve bridle assembly would be buried (not in the vault). Bollards would be used to prevent vehicles from encroaching on the bridle assembly.
- Use existing isolation valves on SL-36-1032 Section 1 for tie-in operations.
- Tie in the new [REDACTED] line north of the valve bridle and the new [REDACTED] line south of the bridle separately to maintain flow to SL-36-9-04 to the south.

Pipeline Safety Enhancement Plan Workpaper Supporting Chapter III
SUPPLY LINE 36-1032 REPLACEMENT PROJECT

Figure 9: Stage 3 Proposed SL-36-1032 Section 1



Pipeline Safety Enhancement Plan Workpaper Supporting Chapter III

SUPPLY LINE 36-1032 REPLACEMENT PROJECT

Additional Considerations

- One mobilization and demobilization.
- Three bell holes for construction and tie-in, north end, south end, and middle valve area.
- In addition, as this section traversed an oil production field, SoCalGas would need to work closely with the oil production customer and comply with their own internal safety policies and procedures.

Section 2

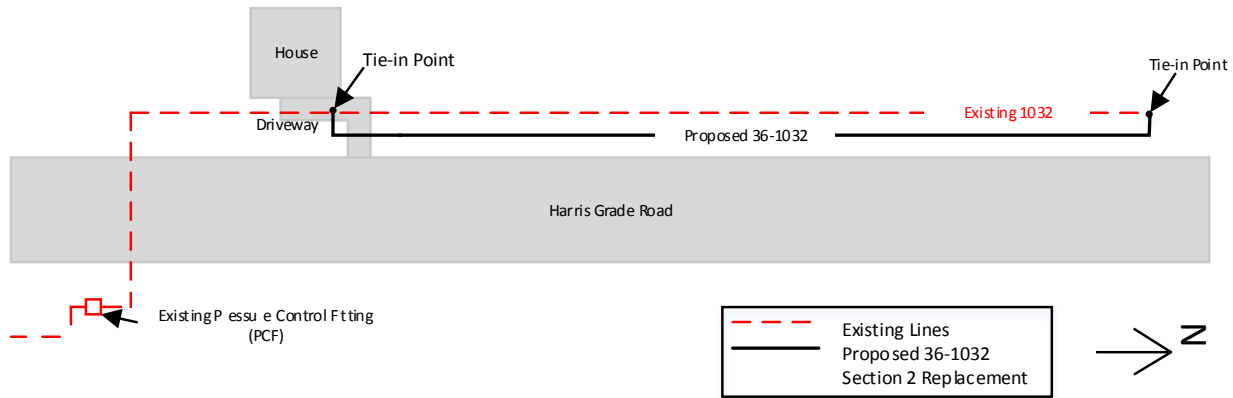
Planning and Design Activity

The initial design for SL-36-1032 Section 2 included (see Figure 10):

- Replace the existing [REDACTED] pipe with [REDACTED] pipe. Install, tie-in, and test the new [REDACTED] [REDACTED] pipeline in the public right-of-way (franchise area) of Harris Grade Road (see Figure 16).
- Use existing isolation valve (north) and pressure control fitting (south) for the tie-in operations.
- Convert one [REDACTED] tap from the old line (high pressure) to another line (medium pressure).
- Develop property exhibits needed to negotiate a new easement in order to route the new line through an easement location into franchise.
- One mobilization and demobilization.
- Two bell holes for tie-in, one north, and one south.
- No substructures conflicting with the path of the project alignment.

Pipeline Safety Enhancement Plan Workpaper Supporting Chapter III
SUPPLY LINE 36-1032 REPLACEMENT PROJECT

Figure 10: Stage 3 Proposed SL-36-1032 Section 2

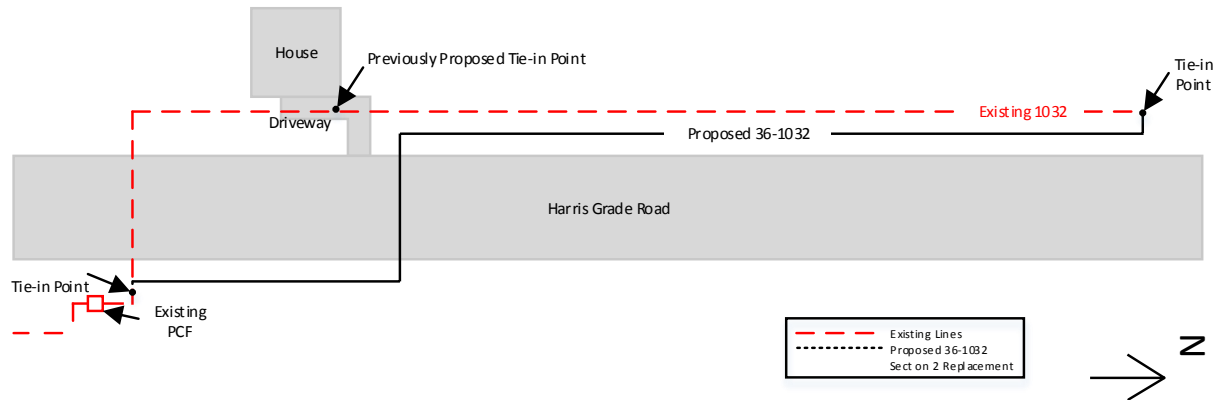


Additional Considerations

- The preliminary design called for installing and tying into the original line in the franchise area (public right-of-way) of Harris Grade Road. This alignment put the tie-in location at the entrance of a residence and required revision (see Figure 11). The revised design to avoid this interference would cross Harris Grade Road and continue along Harris Grade Road before tying into the original line. This added incidental pipe to the project.
- The preliminary design called for using the existing pressure control fitting (south) for tie-in operations. After the alignment change, the tie-in location of the new line into the original line was moved before the pressure control fitting for the southern isolation.

Pipeline Safety Enhancement Plan Workpaper Supporting Chapter III
SUPPLY LINE 36-1032 REPLACEMENT PROJECT

Figure 11: Stage 3 Revised SL-36-1032 Section 2



Section 3

Planning and Design Activity

The initial design for SL-36-1032 Section 3 included:

- Install and test the new [redacted] pipeline. For piggability purposes, replace the existing [redacted] valve in a new vault with a new [redacted] valve and two [redacted] blow-off valves on each side. Remove the old [redacted] valve and vault and abandon the remaining line in place.
- Align the project on the west side of San Miguelito Road.
- Use four bypass stopples during tie-in to maintain gas flow to two regulator stations.

Sections 1, 2 and 3

Estimate of Costs

The project was split into three separately executed sections for purposes previously mentioned; however, it was still considered a single project with a single WOA. Internally, three separate TIC estimates were prepared for the sections (reflecting the unique characteristics of

Pipeline Safety Enhancement Plan Workpaper Supporting Chapter III
SUPPLY LINE 36-1032 REPLACEMENT PROJECT

each section) and then the estimates were combined for preparation of the project WOA. These estimates were based on preliminary designs and included the assumptions of:

- One mobilization and demobilization for each section.
- There were no unknown substructures.
- Due to the potential to uncover cultural artifacts in Section 3 in the city of Lompoc, full-time Native American monitoring during construction and additional archaeological exploration in culturally sensitive areas prior to construction would be required.

In December 2013, using the Stage 3 SCG Pipeline Estimate Template Rev. 0 tool, the estimated total loaded costs for the three replacement sections was determined to \$8,223,969.

Table 3: SL-36-1032 Sections 1, 2 and 3 Phase 2 WOA

Cost Category	Phase 2 WOA
Company Labor Costs	\$929,601
Contract Costs	*
Materials Costs	\$416,777
Other Direct Costs	\$4,589,461
Total Direct Costs	\$5,935,839
Total Indirect Costs	\$2,288,130
Total Loaded Costs	\$8,223,969

**The Phase 2 WOA combined the forecasted Contract Costs with Other Direct Costs.*

Pipeline Safety Enhancement Plan Workpaper Supporting Chapter III

SUPPLY LINE 36-1032 REPLACEMENT PROJECT

Stage 4 – Detailed Engineering Design and Procurement

During Stage 4, detailed design and material procurement was completed in order to provide a construction ready packet to the construction contractor to execute the planned project scope. The following scope changes occurred during this stage:

Section 1

Detailed Planning and Design

- Additional scope validation efforts prior to detailed design identified a reduction of 194 feet of Category 4 mileage for this section.
- A safety fence was added to the plan to further restrict access to the area, along with the bollards planned in Stage 3 to protect the new valve bridle assembly.
- A portion of the bridle assembly's pipe was determined to be incidental mileage, thus resulting in a reduction of Criteria mileage.

Section 2

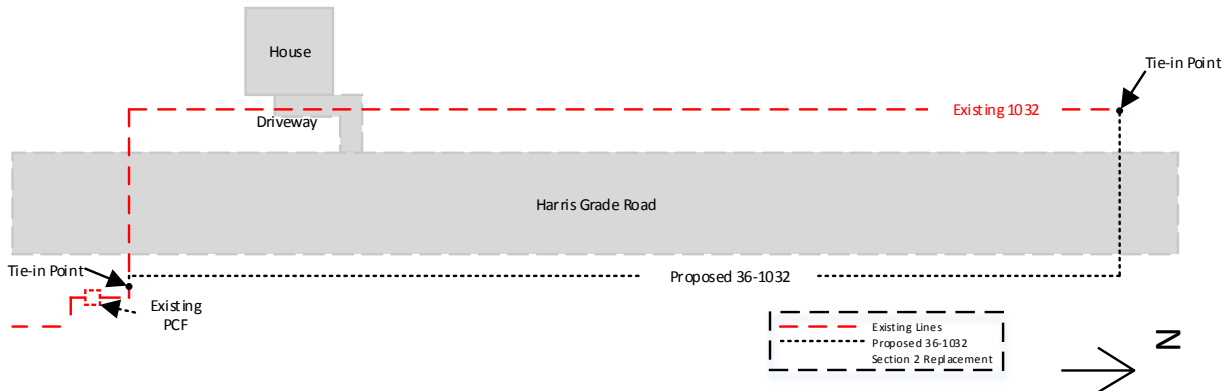
Detailed Planning and Design

- The project alignment was moved to the east side of Harris Grade Road with no change in mileage (see Figure 12).
 - Communications with city staff during the planning process identified that the City of Lompoc planned to widen the road to the west, interfering with the project's proposed project alignment. SoCalGas' franchise agreement indicates any relocation expense would be borne by SoCalGas; therefore, to eliminate the risk of having to relocate the pipe later at an additional expense, the alignment was revised.
- A stopple was added to the design of the north end of the road alignment.

Pipeline Safety Enhancement Plan Workpaper Supporting Chapter III
SUPPLY LINE 36-1032 REPLACEMENT PROJECT

- In Stage 3, it was assumed the existing isolation valve (north) would be used for tie-in operations. During construction of Section 1, the valve that was intended to be used to isolate Section 2 could not sufficiently isolate the line; with this knowledge, a stopple was added to the design.

Figure 12: Stage 4 SL-36-1032 Section 2



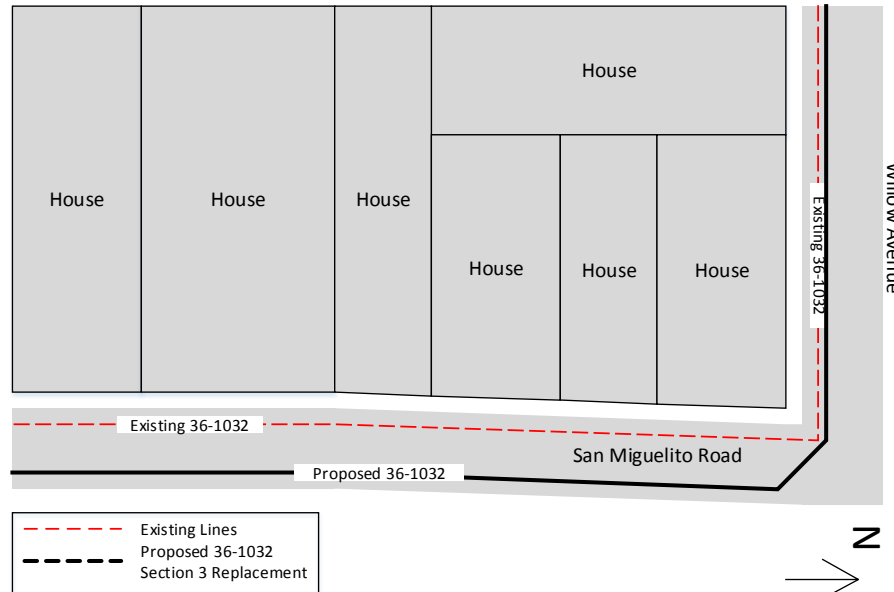
Section 3

Detailed Planning and Design

- The alignment was moved 23 feet to the east (unoccupied) side of San Miguelito Road to avoid driveways and underground utilities and in order to minimize impact to customers and simplify construction (see Figure 13).

Pipeline Safety Enhancement Plan Workpaper Supporting Chapter III
SUPPLY LINE 36-1032 REPLACEMENT PROJECT

Figure 13: Final SL-36-1032 Section 3



Construction Contractor Selection

Section 1 of this project was initiated before the Performance Partnership Program began. Therefore a contractor was selected who had previously been selected to work as a contractor for SoCalGas in this region and had set rates through a prior competitive bid process.

After having completed the first section of this project with outstanding performance, work for Section 2, and later, work for Section 3, was awarded to the same contractor. Additionally, the contractor was a DBE that was being given the opportunity to prove their ability to perform construction on high pressure pipelines.

The Construction Contractor cost for all three sections was \$ [REDACTED] which is \$ [REDACTED] more than the Stage 3 construction contractor direct estimate of \$ [REDACTED] that was used to develop the Phase 2 WOA estimate.

Pipeline Safety Enhancement Plan Workpaper Supporting Chapter III
SUPPLY LINE 36-1032 REPLACEMENT PROJECT

Stage 5 – Construction

Section 1

Schedule

Construction Start Date: 05/12/2014

Construction Finish Date: 07/16/2014

NOP Date: 10/23/2014

Field Conditions

Conditions were encountered in the field that were not anticipated during design and planning that had to be addressed or mitigated. Listed below is a summary of the key field changes broken down by type of change for this section (see Figure 14):

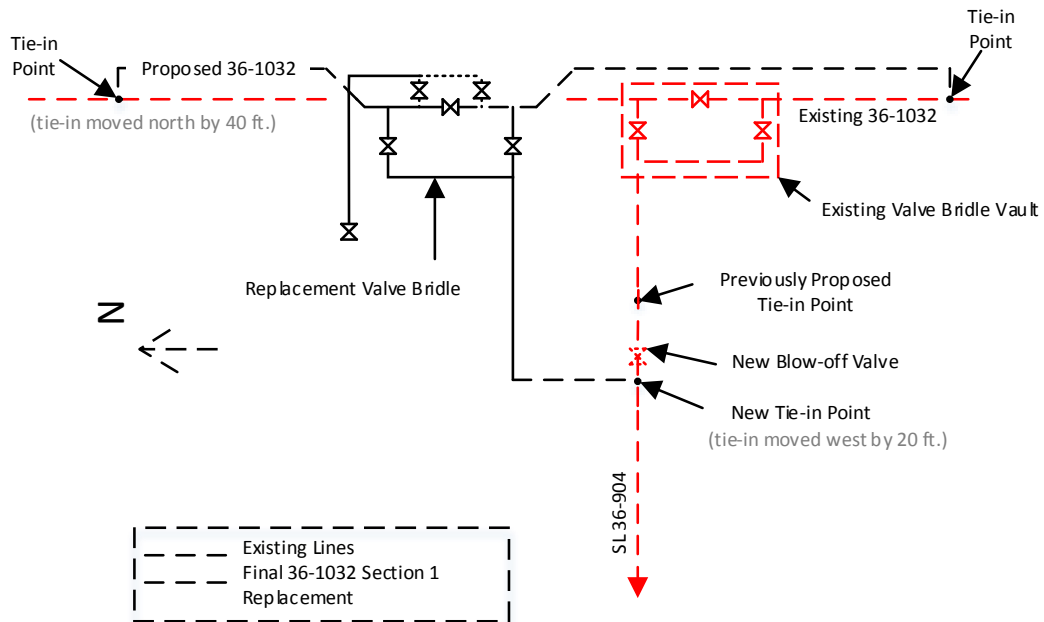
Constructability Issues:

- It was assumed the connection to the feed line to SL-36-9-04 would be upstream of the blow-off valve. Excavation activities revealed the blow-off valve to be attached to a drip pot. The tie-in location was moved by approximately 20 feet to the west, downstream of the blow-off valve to remove the drip pot to improve the integrity of the line. A new blow-off valve was installed. As a result, it was replaced with a full-port [REDACTED] ball valve that was piggable. This caused a schedule delay due to the time needed to acquire materials, which led to a second mobilization.
- The tie-in locations on both the north and south ends were extended beyond the HCA for constructability reasons (to reach pipe segments with sufficient integrity for the tie-in). This resulted in an addition of 74 feet.

Pipeline Safety Enhancement Plan Workpaper Supporting Chapter III
SUPPLY LINE 36-1032 REPLACEMENT PROJECT

- It was determined that stopple fittings were necessary to facilitate a safe tie-in operation; therefore, stopple fittings were added and bell holes were enlarged.
- Footage was added to facilitate the tie-in activities.

Figure 14: Final SL-36-1032 Section 1



Pipeline Safety Enhancement Program Workpaper Supporting Chapter III
SUPPLY LINE 36-1032 REPLACEMENT PROJECT

Section 2

Schedule

Construction Start Date: 07/28/2014

NOP Date: 10/23/2014

Construction Finish Date: 11/05/2014

Field Conditions

Conditions were encountered in the field that were not anticipated during design and planning that had to be addressed or mitigated. Listed below is a summary of the key field changes broken down by type of change for this section (see Figure 15):

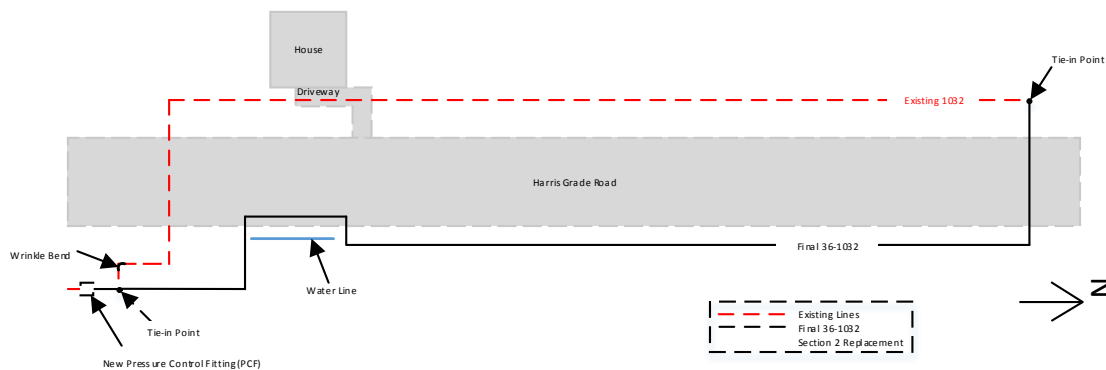
Constructability Issues:

- A new stopple fitting and pipe footage was added to scope.
 - It was assumed the existing pressure control fitting on the south end could be used for tie-in operations. Excavation revealed a wrinkle bend outside the planned workspace, which would prevent piggability. Replacement was extended beyond the wrinkle bend, including the existing pressure control fitting, necessitating its removal. An additional stopple fitting was installed for the southern isolation and tie-in of this line. The south bell hole was significantly expanded to accommodate replacement of the wrinkle bend and other activities noted above.
- In spite of SoCalGas and SDG&E's due diligence in surveying and mapping the area, undocumented substructures, including a plastic water main, were encountered that conflicted with the path of the project alignment. Additional excavation and pipe routing was required to pass under this structure. It was incorrectly marked by the municipality and was not discovered until trench excavation was under way.

Pipeline Safety Enhancement Program Workpaper Supporting Chapter III
SUPPLY LINE 36-1032 REPLACEMENT PROJECT

- SoCalGas was required to temporarily restore a bike path prior to a holiday weekend, which resulted in additional paving activities.

Figure 15: Final SL-36-1032 Section 2



Section 3

Schedule

Construction Start Date:	11/12/2014
NOP Date:	02/06/2015
Construction Finish Date:	03/19/2015

Field Conditions

Conditions were encountered in the field that were not anticipated during design and planning that had to be addressed or mitigated. Listed below is a summary of the key field changes broken down by type of change for this section:

Pipeline Safety Enhancement Program Workpaper Supporting Chapter III
SUPPLY LINE 36-1032 REPLACEMENT PROJECT

Constructability Issues:

- After successful tie-in, one stopple plug became stuck while being removed. A new stopple and a new bypass were installed and the section of pipe with the stuck plug was removed.
- Because of a delay in receiving a new vault for the new [REDACTED] valve bridle, the project demobilized the pipeline crew. Heavy equipment and trailers then remobilized four months later to install the vault with a reduced crew and light equipment.
- Additional incidental mileage of 17 feet was added beyond the valve set for constructability reasons.

Figure 16: Traffic Control Activities and Exposed Pipeline Along Harris Grade Road (Old Highway 1) In Section 2



Pipeline Safety Enhancement Program Workpaper Supporting Chapter III
SUPPLY LINE 36-1032 REPLACEMENT PROJECT

Stages 6 & 7 – Commissioning and Closeout

Commissioning and Close-out Activities

Commissioning activities included site restoration, final inspections, and placement of the pipeline back into service, transportation and disposal of hydrotested water or hazardous material and demobilization from the site. Close out activities included development of final drawings, the reconnection package and updates to company systems to reflect the changes made to the system.

Cost Variance

Table 4: SL-36-1032 Phase 2 WOA Estimate and Actual Costs

COST SUMMARY				
	PHASE 2 WOA	CAPITAL (actuals)	DELTA over/(under)	
COMPANY LABOR	\$ 929,601	\$ 482,765	\$	(446,836)
CONTRACT COSTS	\$ -	\$ 4,917,313	\$	4,917,313
MATERIALS	\$ 416,777	\$ 501,136	\$	84,359
OTHER DIRECTS	\$ 4,589,461	\$ 4,028,014	\$	(561,447)
INDIRECTS	\$ 2,288,130	\$ 1,024,098	\$	(1,264,032)
TOTAL LOADED	\$ 8,223,969	\$ 10,953,327	\$	2,729,358

Table 4 compares the Phase 2 WOA estimate and the March 2016 loaded actual costs. The loaded actual costs exceeded the Phase 2 WOA estimate by \$2,729,358.

The difference between the WOA and the actual costs is mostly attributable to scope changes that occurred after the Phase 2 WOA estimate and unanticipated conditions during construction (including: scope increase to address integrity issues, changes to project alignment, discovery of underground obstructions, water main misidentified by local municipality, removal of a wrinkle bend, material delivery delays, and the need for additional isolation equipment) and an early cost estimating tool and process that was based on preliminary project designs (resulting in underestimating of inspection services, project support costs, water costs, and environmental

Pipeline Safety Enhancement Program Workpaper Supporting Chapter III
SUPPLY LINE 36-1032 REPLACEMENT PROJECT

costs). These increased costs were reasonably incurred to complete this replacement work, but were not fully accounted for in the Stage 3 estimate.

Disallowances

There was no disallowance for the SL-36-1032 Sections 1, 2 and 3 Replacement Project as there were no post-1955 segments included in the project without records that provide the minimum information to demonstrate compliance with industry standards or regulatory strength testing and recordkeeping requirements then applicable.

Pipeline Safety Enhancement Program Workpaper Supporting Chapter III
SUPPLY LINE 36-1032 REPLACEMENT PROJECT

Conclusion

SoCalGas and SDG&E enhanced the safety of their natural gas system by prudently executing the SL-36-1032 Sections 1, 2 and 3 Replacement Project. Through this replacement project, SoCalGas and SDG&E successfully replaced 0.653 miles of non-contiguous high-pressure, [REDACTED] diameter pipe in the city of Lompoc. Construction began on the SL-36-1032 Sections 1, 2 and 3 Replacement Project in May 2014 and was completed in July 2015. The project incurred a total loaded project cost of \$10,953,327. There were no disallowances for this project.

SoCalGas and SDG&E executed this project prudently: maintaining service to customers; safely executing a complex multi-sectional project (requiring full-time Native American monitoring and additional archaeological exploration in culturally sensitive areas of Section 3 and relocating pipelines to avoid driveways and other underground utilities and requiring work in the road and near customers); responding prudently to unknown conditions (expanding scope to address integrity issues such as wrinkle bends and to improve overall pipeline piggability); and prudently addressing delays and unanticipated field changes (expanded scope and discovery of unknown subsurface facilities).

SoCalGas and SDG&E's total loaded project cost of \$10,953,327 is reasonable and should be approved. SoCalGas and SDG&E engaged in prudent cost avoidance efforts (validating scope to reduce Category 4 Criteria mileage; coordinating with the City of Lompoc to re-route a portion of Section 2 in Harris Grade Road in consideration of future street widening plans and avoid having to later relocate the pipeline; and also by extending the work on that portion to remediate a short portion of an adjacent PSEP Phase 1B segment, thereby avoiding later mobilization/demobilization costs and construction activities in the future); engaged in reasonable efforts to promote market-based rates for contractor services and materials (see Chapter II (Phillips)(approximately 98% of PSEP agreements with contractors and suppliers were either competitively bid or through agreements entered into using market-based rates based on a recent competitive sourcing event)); and used a reasonable amount of company labor and contractor resources given the project's complexity.

End of SL-36-1032 Sections 1, 2 and 3 Replacement Project Workpaper

Pipeline Safety Enhancement Program Workpaper Supporting Chapter III
SUPPLY LINE 38-539 REPLACEMENT PROJECT

Summary

Table 1: SL-38-539 Replacement Project Summary

Project Name	SL-38-539 Replacement Project
WOA Number/WOA Date	82051/June 25, 2014
City	Tulare
Original Pipe Diameter/ New Pipe Diameter	██████████
Construction Start	October 13, 2014
Construction Finish	April 10, 2015
Loaded Capital Costs	\$16,915,804
Loaded O&M Costs	\$ 0
Total Loaded Project Costs	\$16,915,804
Disallowance	\$ 0

Description

Through the SL-38-539 Replacement Project, SoCalGas and SDG&E enhanced its pipeline system by successfully replacing 2.613 miles of 1949 vintage high-pressure, ██████████ diameter pipe with ██████████ diameter pipe in the city of Tulare and unincorporated areas of the county of Tulare, as shown in Figures 1 and 2 and Table 2 that describe the project scope as of the 2011 PSEP filing date and the final mileage.

Examples of cost avoidance actions included:

- An alternative construction procedure was utilized in lieu of using CNG to reduce costs.
- Secured a bulk purchasing opportunity for pipe.

Construction began in October 2014 and was completed in April 2015. The SL-38-539 Replacement Project incurred a total loaded project cost of \$16,915,804.

Pipeline Safety Enhancement Program Workpaper Supporting Chapter III
SUPPLY LINE 38-539 REPLACEMENT PROJECT

Table 2: SL-38-539 2011 PSEP Filing and Final Mileage*

Line 38-539	Total Mileage	Criteria Mileage	Accelerated Mileage**	Incidental Mileage
2011 PSEP Filing	12.083 mi.	2.361 mi.	9.722 mi.	0
Total	2.613 mi.	2.014 mi.	0.599 mi.	0

*Values may not add to total due to rounding.

**Accelerated mileage includes Phase 1B and Phase 2 pipe. Phase 2 includes pipelines without sufficient record of a pressure test in less populated areas (Phase 2A) or pipelines with record of a pressure test, but without record of a pressure test to modern – Subpart J – standards (Phase 2B). Included in this project was 0.599 miles of pipe accelerated from Phase 2A. The accelerated mileage was included to realize efficiencies and to enhance project constructability.

Pipeline Safety Enhancement Program Workpaper Supporting Chapter III
SUPPLY LINE 38-539 REPLACEMENT PROJECT

Figure 1: Overview Map of SL-38-539 Replacement Project



Pipeline Safety Enhancement Program Workpaper Supporting Chapter III
SUPPLY LINE 38-539 REPLACEMENT PROJECT

Figure 2: Satellite Image of SL-38-539 Replacement Project



Pipeline Safety Enhancement Program Workpaper Supporting Chapter III SUPPLY LINE 38-539 REPLACEMENT PROJECT

Stage 1 – Project Initiation

In workpapers supporting the 2011 PSEP filing,¹ SoCalGas and SDG&E identified the SL-38-539 Project as a Phase 1A replacement project. It comprised approximately 2.361 Category 4 Criteria miles and 9.722 accelerated miles of primarily [REDACTED] diameter high-pressure pipe that runs through the city of Tulare and unincorporated areas of the county of Tulare. Consistent with the long-term plan to replace the existing pipe (which consists of varying diameters) with [REDACTED] for uniformity and piggability purposes, this project replaced [REDACTED] with [REDACTED] pipe.

During Stage 1, SoCalGas and SDG&E completed scope validation, confirmed that the SL-38-539 was installed in 1949, and determined that the Category 4 Criteria mileage decreased and the accelerated mileage had increased. The reasons for the mileage changes were as follows:

- Category 4 Criteria mileage decreased because of a class location change from Class 3 to Classes 1 and 2.
- Evaluation of the Feature Study indicated that the Category 4 endpoints should be changed which increased accelerated mileage.

Based on these changes the total replacement mileage was increased from 12.083 miles to 13.230 miles.

¹ See December 2, 2011 Amended Pipeline Safety Enhancement Plan (PSEP) of SoCalGas and SDG&E.

Pipeline Safety Enhancement Program Workpaper Supporting Chapter III SUPPLY LINE 38-539 REPLACEMENT PROJECT

Stage 2 – Analysis and Findings

During Stage 2, data analysis was performed and the findings were used to define project scope and to plan tasks for later stages of the project.

Through scope validation the Category 4 mileage was decreased. Two Category 4 Criteria sections were originally identified in the PSEP filing as Class 3 locations, however, these sections were confirmed to be Class 1 and 2.

An RER determined that the line could not be shut in without customer impacts, and that the work would need to be divided into five sections to keep customers on line during the replacement work. These sections were identified on the basis of existing valve, tap, and customer locations. As a result of this division, only one Category 4 Criteria section with adjacent accelerated mileage remained. All other accelerated mileage was deferred to Phase 2.

Engineering Factors

A PSEP Decision Tree and TVR analysis of SL-38-539 indicated that the project would remain a replacement because:

- The pipeline cannot be shut down for the duration of a hydrotest because of customer impacts. It is the main artery that supplies gas to core customers and therefore could not be shut down for 2 or more weeks.
- The pipeline had varying diameters of pipe. These differing diameters made the pipeline unpiggable. Therefore, the plan was to replace the existing pipe with [REDACTED] pipe to make the line uniform and piggable.

On the basis of customer impact and piggability, the analysis supported the decision to replace the pipeline.

Pipeline Safety Enhancement Program Workpaper Supporting Chapter III SUPPLY LINE 38-539 REPLACEMENT PROJECT

Stage 3 – Initial Planning and Design

During Stage 3, SoCalGas and SDG&E developed a Phase 2 WOA estimate and began field surveys to complete preliminary design drawings and further refine the scope. Preliminary drawings were also used to initiate procurement of long lead materials.

In addition to the schedule and estimate, other key activities include identifying all permits, TREs, and easements, defining long lead materials and pricing, understanding customer impacts and potential interruptions, and preparing any necessary environmental submittals.

Accelerated mileage was further reduced during Stage 3 for this project in order to minimize customer impact. The final replacement scope was reduced from 3.555 miles to 2.610 miles.

Planning and Design Activity

The initial planning and design for the SL-38-539 Replacement Project included:

- Replacement of [REDACTED] with [REDACTED] diameter pipe allowing for piggability.
- Installing pressure control fittings to prevent impact to core customers.
- Placement of the new pipeline alignment would be within the existing public right-of-way (franchise area) for operations and maintenance accessibility.
- The project would require one mobilization and demobilization.
- The hydrotesting of the replacement pipeline would be completed in eight hours.
- Gas handling for the tie-in would be completed in two days.

Additional Considerations

- The construction contractor would not be needed during the line seasoning process.

Pipeline Safety Enhancement Program Workpaper Supporting Chapter III
SUPPLY LINE 38-539 REPLACEMENT PROJECT

- The pipeline’s coating was assumed to contain environmentally sensitive material. As a result, to reduce potential project delays, abatement crews were scheduled to be on-site during every bell hole operation.
- Water would not need to be treated because new pipe was being tested.
- Surrounding soil would be free from contaminants.

Cost Avoidance

- Pressure control bottom out fittings were utilized for tie-in because CNG was determined to be more expensive and presented an increased potential risk in the loss of customers.
- The project purchased pipe and fittings through bulk order to achieve a lower cost.

Estimate of Costs

The estimated total loaded cost for the 2.613 miles was \$13,761,819, as shown in Table 3 and was based on preliminary designs. This estimate was prepared in June 2014 using the Stage 3 SCG Pipeline Estimate Template Rev 0 tool.

Table 3: SL-38-539 Phase 2 WOA Estimate

Cost Category	Phase 2 WOA
Company Labor Costs	\$949,117
Contract Costs	\$9,664,072
Material Costs	\$598,423
Other Direct Costs	\$557,214
Total Direct Costs	\$11,768,826

Pipeline Safety Enhancement Program Workpaper Supporting Chapter III
SUPPLY LINE 38-539 REPLACEMENT PROJECT

Total Indirect Costs	\$1,992,993
Total Loaded Costs	\$13,761,819

Pipeline Safety Enhancement Program Workpaper Supporting Chapter III
SUPPLY LINE 38-539 REPLACEMENT PROJECT

Stage 4 – Detailed Engineering Design and Procurement

During Stage 4, detailed design and material procurement was completed in order to provide a construction ready packet to the construction contractor to execute the planned project scope. SoCalGas and SDG&E acquired all permits (City and County of Tulare). In addition, SoCalGas performed potholing and GPR activities.

Detailed Planning and Design

There were no scope changes from Stage 3 to Stage 4.

Construction Contractor Selection

Construction of the SL-38-539 Replacement Project utilized the PSEP Performance Partner Program and the construction contract was awarded to the Performance Partner for this geographic area.

The Performance Partner/Construction Contractor TPE was \$ [REDACTED], which is \$ [REDACTED] less than the Stage 3 construction contractor direct estimate of \$ [REDACTED] that was used to develop the Phase 2 WOA.

Pipeline Safety Enhancement Program Workpaper Supporting Chapter III
SUPPLY LINE 38-539 REPLACEMENT PROJECT

Stage 5 – Construction

Schedule

Construction Start Date: 10/13/2014

NOP Date: 03/13/2015

Construction Finish Date: 04/10/2015

As noted below, the schedule was delayed due to several factors.

Field Conditions

Conditions were encountered in the field that were not anticipated during design and planning that had to be addressed or mitigated. Listed below is a summary of the key field changes broken down by type of change for this project.

Material Delivery Delays:

- Suppliers were unable to meet the scheduled deliverable dates. In order to minimize cost impacts, the delayed materials were installed out of sequence to reduce the number of demobilizations and limit standby costs. Re-excavation at the site was required once delayed materials for Robotic Pig fitting was received and installed.

Weather:

- Inclement weather and Tule fog² caused ten construction stoppages for safety reasons.

² Tule fog is a thick ground fog that settles in the San Joaquin Valley and Sacramento Valley areas of California's Great Central Valley. The Performance Partner was unable to execute construction when Tule fog was present because the fog presented unsafe working conditions.

Pipeline Safety Enhancement Program Workpaper Supporting Chapter III
SUPPLY LINE 38-539 REPLACEMENT PROJECT

Additional Support:

- SoCalGas assumed that hydrotesting the new line would be completed in 108 hours. However, the hydrotest lasted a total of 12 hours. Preparation and clean up took two hours each, respectively, which added four hours to entire process. Additional support was necessary to perform a successful and safe hydrotest.
- As discussed in Stage 3, SoCalGas assumed that the construction contractor would not be needed during the line seasoning operation. However, the line seasoning process took longer than anticipated and construction contractor support was determined to be necessary.

Environmental Abatement:

- When SoCalGas discovered the pipe coating was in poor condition (the coating had disbonded and debris was present in the soil), abatement crews were required more frequently and for a longer duration than previously planned. Coal tar wrap, a type of coating that often contains asbestos material, requires an Industrial Hygienist to monitor on-site conditions.

Soil Contamination:

- Soil contamination was found while excavating, causing delays in construction production.

Pipeline Safety Enhancement Program Workpaper Supporting Chapter III
SUPPLY LINE 38-539 REPLACEMENT PROJECT

Water Quality:

- After hydrotesting the pipe, the water was discovered to be discolored, requiring additional water testing and treatment onsite before being reused for dust control. Additional pig runs were necessary to confirm the pipe was clean. The treatment was not planned or included in the cost estimate resulting in the need to extend the schedule of environmental staff involvement in the hydrotest.

Substructures:

- SoCalGas potholed and utilized GPR technologies to best identify existing substructures. Although best practices were followed, not all substructures were identified which expanded the project scope to address the congestion of the underground substructures.

Constructability:

- Increased construction was required because the tie-in configurations were modified for constructability purposes and safety. Specifically, when excavating and exposing existing pipe, space constraints arose because of utility facility conflicts which required a change in design and construction.

Gas Handling:

- SoCalGas estimated the final tie-in duration to be two 12-hour days. Due to complexity with maintaining a constant flow to customers, gas handling and tie-in modifications were necessary. In addition, Operating District support was necessary to complete these tie-ins, which were performed sequentially at each lateral. The final tie-in duration was 7 days to complete all 4 tie-ins due to this unexpected complexity.

Pipeline Safety Enhancement Program Workpaper Supporting Chapter III
SUPPLY LINE 38-539 REPLACEMENT PROJECT

Customer Impact Mitigation:

- As discussed earlier, the project did not plan to use CNG. However, CNG was made available to supplement the gas flow for an individual customer that required a specific flow rate. This flow rate may not have been possible during the tapping activity and cool weather conditions when flow would be briefly restricted.

Permit Conditions:

- Road conditions were not as anticipated; asphalt was thin and failed under the use of normal construction equipment (see Figure 3). Extensive paving repairs were required to meet city and county requirements.

Pipeline Safety Enhancement Program Workpaper Supporting Chapter III
SUPPLY LINE 38-539 REPLACEMENT PROJECT

Figure 3: Placing Pipe in Trench with Side Boom Equipment along S I Street and plates to protect asphalt



Pipeline Safety Enhancement Program Workpaper Supporting Chapter III
SUPPLY LINE 38-539 REPLACEMENT PROJECT

Stages 6 and 7 – Commissioning and Closeout

Commissioning activities included site restoration, final inspections and placement of the pipeline back into service, transportation and disposal of the hydrotested water and hazardous material and demobilization from the site. Close-out activities included development of final drawings, the reconciliation package and updates to company systems to reflect the changes made to the system.

Cost Variance

Table 4: SL-38-539 Phase 2 WOA Estimate and Actual Costs

COST SUMMARY			
	PHASE 2 WOA	CAPITAL (actuals)	DELTA over/(under)
COMPANY LABOR	\$ 949,117	\$ 673,382	\$ (275,735)
CONTRACT COSTS	\$ 9,664,072	\$ 10,577,981	\$ 913,909
MATERIALS	\$ 598,423	\$ 634,237	\$ 35,814
OTHER DIRECTS	\$ 557,214	\$ 3,514,871	\$ 2,957,657
INDIRECTS	\$ 1,992,993	\$ 1,515,333	\$ (477,660)
TOTAL LOADED	\$ 13,761,819	\$ 16,915,804	\$ 3,153,985

Table 4 compares the Phase 2 WOA estimate and the March 2016 loaded actual costs. The loaded actual costs exceeded the Phase 2 WOA estimate by \$3,153,985.

The above variance is attributable to scope changes and unanticipated conditions that occurred after the Phase 2 WOA estimate (including: material delivery delays; weather delays; additional time and resources were needed to complete the hydrotesting and seasoning of the new line; disbonded coal tar wrap and debris; soil contamination; water treatment costs; unidentified subsurface facilities; redesign of tie-in configuration; additional time to tie the new pipe and maintain flow to customers; CNG support; and permit conditions requiring additional road repairs and safety equipment). These increased costs were reasonably incurred to complete the pipeline replacement, but were not accounted for in the Stage 3 estimate.

Pipeline Safety Enhancement Program Workpaper Supporting Chapter III
SUPPLY LINE 38-539 REPLACEMENT PROJECT

Disallowances

There was no disallowance for the SL-38-539 Replacement Project as there were no post-1955 segments included in the project without records that provide the minimum information to demonstrate compliance with industry standards or regulatory strength testing and recordkeeping requirements then applicable.

Pipeline Safety Enhancement Program Workpaper Supporting Chapter III
SUPPLY LINE 38-539 REPLACEMENT PROJECT

Conclusion

SoCalGas and SDG&E enhanced the safety of their natural gas system by prudently executing the SL-38-539 Replacement Project. Through this replacement project, SoCalGas and SDG&E successfully replaced 2.014 Category 4 Criteria miles and 0.599 accelerated miles of pipeline in the city of Tulare and unincorporated Tulare County. The project incurred a total loaded project cost of \$16,915,804.

SoCalGas and SDG&E executed this project prudently: minimizing customer impacts; engaging in prudent cost avoidance efforts; replacing pipe of varying diameters with [REDACTED] pipe to enhance uniformity and piggability; and designing the project alignment in an existing right-of-way for operations and maintenance accessibility.

SoCalGas and SDG&E's total loaded project cost of \$16,915,804 is reasonable and should be approved. SoCalGas and SDG&E engaged in prudent cost avoidance efforts (bulk purchasing materials and using an alternative construction procedure in lieu of CNG); engaged in reasonable efforts to promote competitive and market-based rates for contractor services and materials (see Chapter II (Phillips) (approximately 98% of PSEP agreements with contractors and suppliers were either competitively bid or through agreements entered into using market-based rates based on a recent competitive sourcing event); and used a reasonable amount of company and contractor resources given the complex scope of work (congested subsurface area in a roadway and need to maintain flow to customers); material delivery and weather-related delays; environmental remediation challenges; unanticipated substructures and utility conflicts causing changes in design and construction; and unanticipated road conditions and related repairs.

End of SL-38-539 Replacement Project Workpaper

**Pipeline Safety Enhancement Program Workpaper Supporting Chapter III
LINE 406 REPLACEMENT & HYDROTEST PROJECTS**

Summary

Table 1: Summary of L-406 Replacement and Hydrotest Projects

Project Name	L-406 Replacement (Sections 1, 2A, 4 and 5) and Hydrotest (Section 2) Project
WOA Number / Date:	25374 and 91050 / May 19, 2014
Section1 (Replacement)	91050.001 / May 19, 2014
Section 2 (Hydrotest)	91050.002 and 25374.002 / May 19, 2014
Section 2A (Replacement)	91050.003 / May 19, 2014
Section 4 (Replacement)	91050.001 / May 19, 2014
Section 5 (Replacement)	91050.001 / May 19, 2014
Cities:	
Section1 (Replacement)	Ventura
Section 2 (Hydrotest)	Camarillo
Section 2A (Replacement)	Thousand Oaks
Section 4 (Replacement)	Encino
Section 5 (Replacement)	Somis
Original Pipe Diameter/New Diameter	██████████
Construction Start / Finish:	
Section1 (Replacement)	August 4, 2014 / January 9, 2015
Section 2 (Hydrotest)	October 20, 2014 / March 11, 2015
Section 2A (Replacement)	October 20, 2014 / March 11, 2015
Section 4 (Replacement)	August 11, 2014 / September 23, 2014
Section 5 (Replacement)	August 11, 2014 / September 24, 2014
Loaded Capital Costs	\$ 7,255,313
Loaded O&M Costs	\$ 3,220,138
Total Loaded Project Costs	\$10,475,451
Disallowance	\$ 0

Pipeline Safety Enhancement Program Workpaper Supporting Chapter III LINE 406 REPLACEMENT & HYDROTEST PROJECTS

Background

L-406 is an approximately 51.47 mile high pressure transmission line of primarily [REDACTED] pipe that traverses the cities of Ventura, Somis, Camarillo, Thousand Oaks, and Woodland Hills, terminating in Encino. To better manage the planning and construction efforts, as well as lessen the customer impact, L-406 was divided into six sections, four replacement sections and two hydrotest sections in order to optimize planning and construction efforts. Five of the sections will be presented in this workpaper: Sections 1, 2, 2A, 4, & 5. Section 3 was re-scoped following an additional review that changed the project from a replacement to a hydrotest project and will be presented as separate workpaper in a later filing. Although preliminary engineering and design activity occurred related to Section 3, it is not described in this workpaper. This workpaper will describe Sections 1, 2, 2A, 4, and 5.

Description

Through the L-406 Replacement (Sections 1, 2A, 4, and 5) and Hydrotest (Section 2) Project, SoCalGas and SDG&E enhanced its high-pressure transmission pipeline system by successfully replacing approximately 1,000 feet of pipe and hydrotesting over 1 mile of pipeline, as shown in Figures 1 through 12 and Table 2 that describes the project scope as of the 2011 PSEP filing and the final construction mileage.

Examples of cost avoidance actions included:

- Through early stage scope validation Category 4 Criteria mileage was reduced from 7.863 mi. to 0.518 mi.
- L-406 Section 2 expanded test scope to accelerate a long stretch of Phase 2 pipe realizing efficiencies by avoiding future work on the pipeline.
- L-406 Section 2A work was expedited to coincide with L-406 Section 2 and eliminated 1 mobilization and demobilization in Phase 2.

Pipeline Safety Enhancement Program Workpaper Supporting Chapter III
LINE 406 REPLACEMENT & HYDROTEST PROJECTS

- L-406 Section 4 was accelerated into the Pipeline Integrity project that was already in construction.

Construction began in August 2014 and this series of projects was completed in March 2015.

The L-406 Replacement and Hydrotest Project incurred a total loaded project cost of \$10,475,451.

Pipeline Safety Enhancement Program Workpaper Supporting Chapter III
LINE 406 REPLACEMENT & HYDROTEST PROJECTS

Table 2: L-406 Replacement and Hydrotest Projects 2011 Filing and Final Mileage*

Line 406	Total Mileage (miles)	Criteria Mileage	Accelerated Mileage**	Incidental Mileage
2011 PSEP Filing	20.700 mi	7.863 mi	12.838 mi	0.000
Final Project Mileage				
Section 2 (Hydrotest)	0.980 mi	888 ft.	0.809 mi.	16 ft.
Section 1 (Replacement)	772 ft	670 ft	102 ft	0
Section 2A (Replacement)	36 ft	0	31 ft	5 ft
Section 4 (Replacement)	45 ft	43 ft	0	2 ft
Section 5 (Replacement)	130 ft	100 ft	0	30 ft
Total	1.166 mi.	0.322 mi.	0.834 mi	53 ft.

*Values may not add to total due to rounding.

**Accelerated mileage includes Phase 1B and Phase 2 pipe. Phase 2 includes pipelines without sufficient record of a pressure test in less populated areas (Phase 2A) or pipelines with record of a pressure test, but without record of a pressure test to modern – Subpart J – standards (Phase 2B). Included in this project was 0.834 miles of pipe accelerated from Phase 2A. The accelerated mileage was included to realize efficiencies and to enhance project constructability.

Pipeline Safety Enhancement Program Workpaper Supporting Chapter III
LINE 406 REPLACEMENT & HYDROTEST PROJECTS

Figure 1: Overview Map of L-406 Replacement and Hydrotest Projects

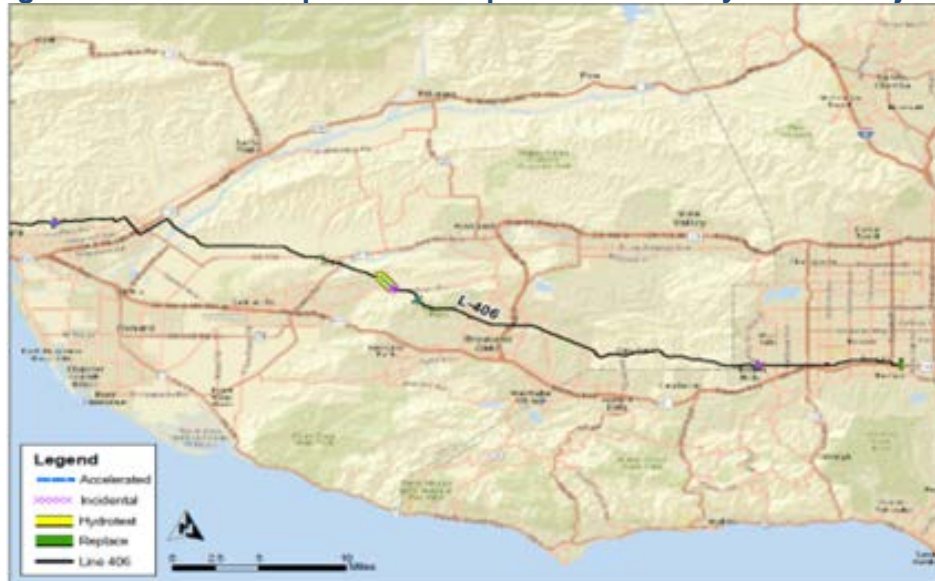


Figure 2: Satellite Image of Overview Map of L-406 Replacement and Hydrotest Projects



Pipeline Safety Enhancement Program Workpaper Supporting Chapter III
LINE 406 REPLACEMENT & HYDROTEST PROJECTS

Figure 3: Overview Map of L-406 Section 1 Replacement Project

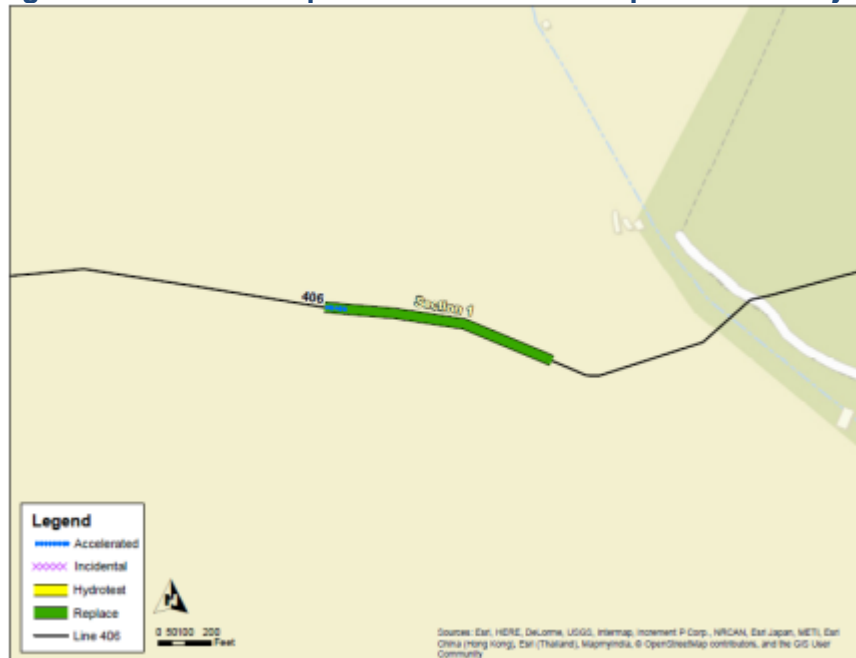


Figure 4: Satellite Image of L-406 Section 1 Replacement Project



Pipeline Safety Enhancement Program Workpaper Supporting Chapter III
LINE 406 REPLACEMENT & HYDROTEST PROJECTS

Figure 5: Overview Map of L-406 Section 2 Hydrotest Project

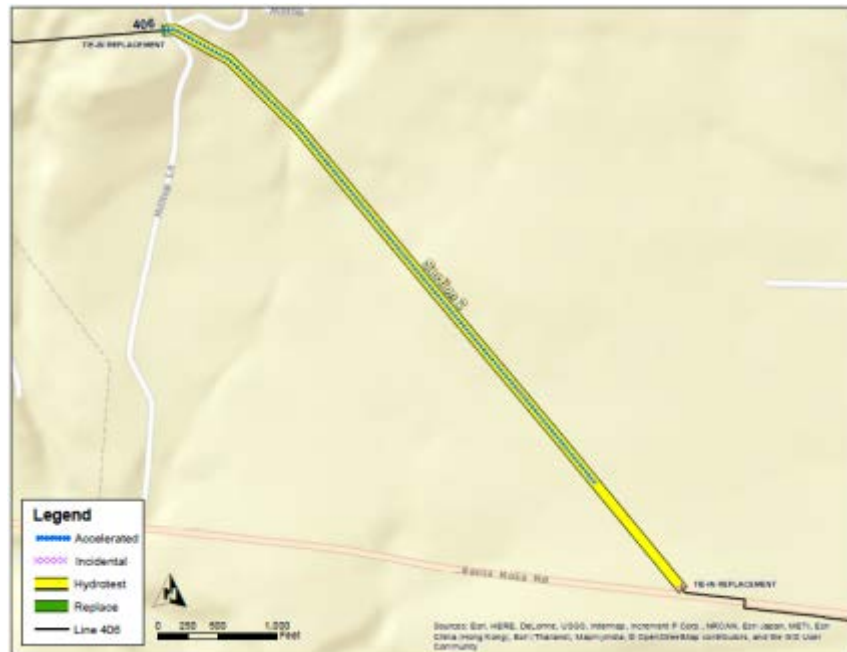
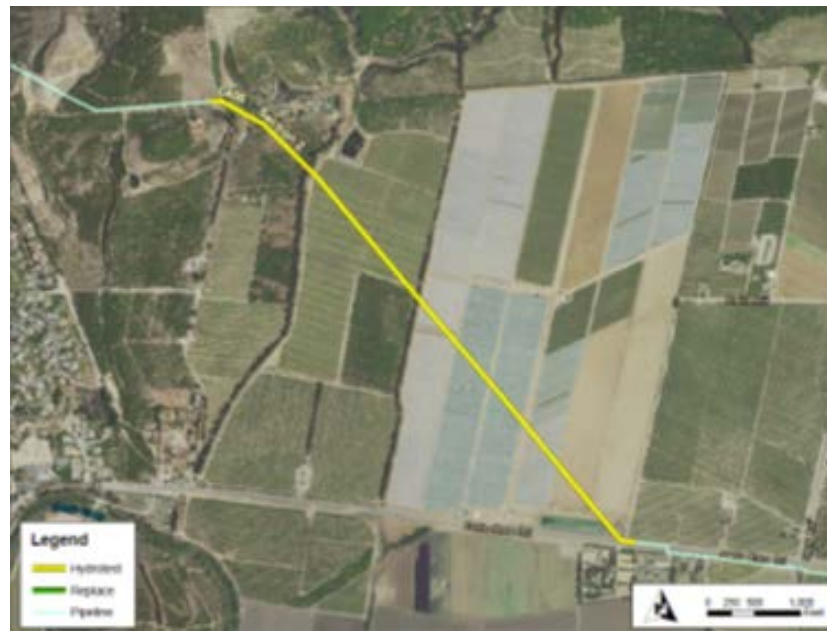


Figure 6: Satellite Image of L-406 Section 2 Hydrotest Project



Pipeline Safety Enhancement Program Workpaper Supporting Chapter III
LINE 406 REPLACEMENT & HYDROTEST PROJECTS

Stage 1 – Project Initiation

In workpapers supporting the 2011 PSEP filing,¹ SoCalGas and SDG&E identified L-406 as a Phase 1A, 20.70 mile hydrotest project, of which 7.863 miles was Category 4 Criteria.

During Stage 1, SoCalGas and SDG&E completed scope validation analysis of L-406 and verified a scope reduction of 7.863 miles to 0.518 miles of Category 4 Criteria mileage.

¹ See December 2, 2011 Amended Pipeline Safety Enhancement Plan (PSEP) of SoCalGas and SDG&E.

Pipeline Safety Enhancement Program Workpaper Supporting Chapter III
LINE 406 REPLACEMENT & HYDROTEST PROJECTS

Stage 2 – Analysis and Findings

During Stage 2, records were analyzed to further refine the scope and determine the selection of pressure testing or replacement to confirm the Decision Tree outcome.

L-406 was filed in the PSEP as a strength test.

Engineering Factors

Sections 1, 2A, 4, and 5

Based on the PSEP Decision Tree, SoCalGas and SDG&E confirmed that L-406 Sections 1, 2, 2A, 4 and 5 should commence as replacement projects. The PSEP Decision Tree directs that scope less than 1,000 feet should be replaced because, under most circumstances, replacements will be the cost effective option. In this instance there were no conditions that justified overriding this guidance.

The total Category 4 mileage for each replacement section was identified as follows:

Section 1: 772 feet

Section 2A: 31 feet

Section 4: 43 feet

Section 5: 100 feet

Sections 1, 2A, 4 and 5 were confirmed as replacement projects because the scope of each project was less than 1,000 feet. In addition, Section 4 was adjacent to a planned Pipeline Integrity replacement project which could be cost effectively expanded to include this section of PSEP pipe.

Pipeline Safety Enhancement Program Workpaper Supporting Chapter III

LINE 406 REPLACEMENT & HYDROTEST PROJECTS

Section 2

- Criteria mileage within Section 2 was 888 feet. However, there was Category 4 non-criteria pipe adjacent to the 888 feet that would need to be addressed in Phase 2. The project was expanded to include the accelerated mileage and create one long hydrotest, eliminate one gas blowdown, and reduce PSEP program costs.
- Section 2 is a 5,157 ft. (0.977 mi) section that was confirmed as a hydrotest project because it was greater than 1,000 feet, had manageable customer impacts, and no significant engineering factors supporting replacement. Accelerated mileage was incorporated to capture efficiencies.

Pipeline Safety Enhancement Program Workpaper Supporting Chapter III LINE 406 REPLACEMENT & HYDROTEST PROJECTS

Stage 3 – Initial Planning and Design

During Stage 3, SoCalGas and SDG&E developed a Phase 2 WOA estimate and began field surveys to complete preliminary design drawings and further refine scope.

In addition to the schedule and estimate, other key activities include identifying all permits, TRE's, and easements, defining long lead materials and pricing, understanding customer impacts and interruptions, and preparing any necessary environmental submittals.

Planning and Design Activities

Project Specific Initial Planning and Design Assumptions are described below for each Section:

Section 1 - Replacement Project

This section starts in the hills north of Ventura by Barlow Canyon Road. The section extends east, ending just west of the baseball fields at Arroyo Verde Park.

Additional Considerations

- Construction would be completed within 3 months if system capacity permitted.
- Permits may not be granted in a timely manner; given the known delays being experienced in this area.
- Daytime construction, 5 days a week, with no overtime.
- One mobilization/demobilization.

Section 2 - Hydrotest Project

- This test location will begin north of Quito Park on Hilltop Lane in Camarillo and extend to Santa Rosa Road and will include approximately 888 feet of Category 4 Criteria pipe with an additional 4,269 feet of Phase 2 accelerated pipe.

Pipeline Safety Enhancement Program Workpaper Supporting Chapter III LINE 406 REPLACEMENT & HYDROTEST PROJECTS

Additional Considerations

- Due to the end point of the criteria section being in farm land, the project design was extended to a location next to a road, which added incidental mileage.
- The schedule would need to be coordinated with the shut-in schedule of a power plant.
- Agency permits may not be granted in a timely manner given the known delays being experienced in this area.
- It was anticipated that construction could proceed more quickly in an agricultural area and site restoration would be less costly.
- Daytime construction.
- Negotiations are needed to obtain 2 TREs for installation of the test heads on private property.
- One mobilization/demobilization.

Section 2A - Replacement Project

A short segment of Phase 2 Category 4 pipe was identified within the shut-in and gas blow down limits for Section 2, thus Section 2A was replaced during this shut-in to eliminate a future blowdown and shut-in. Sections 2 and 2A are over 1-mile away from each other.

Additional Considerations

The work would be in a non-congested area for excavation.

- Daytime construction.
- A TRE would be needed from the City of Thousand Oaks Public Works Department.

**Pipeline Safety Enhancement Program Workpaper Supporting Chapter III
LINE 406 REPLACEMENT & HYDROTEST PROJECTS**

Section 4 - Replacement Project

Section 4 was initiated earlier as it was immediately adjacent to a Pipeline Integrity (PI) ILI project which was easily expandable to include the PSEP scope of 43 ft. of Category 4 mileage. This allowed PSEP to complete this project with significant cost savings and the reduced community and system impact of a second construction project.

Section 5 - Replacement Project

Section 5 consisted of 130 feet to be replaced with one mobilization/demobilization and daytime construction. This also required removal of coal tar wrap and asbestos abatement of existing pipe (see figure 13).

Estimate of Costs

The estimate was prepared on May 19, 2014 using the Stage 3 SCG Pipeline Estimate Template Rev 0 estimating tool and was based on preliminary design. In Table 3, the Phase 2 WOA estimate includes forecasted loaded costs for 5 sections of L-406 (Sections 1, 2, 2A, 3, and 5) and was created as a single parent Work Order Authorization (WOA). Note that the Phase 2 WOA estimate (Table 3) includes costs for Section 3, which was subsequently re-scoped to a later date, and does not include costs for Section 4.

Table 3: L-406 Phase 2 WOA Estimate

Cost Category	Phase 2 WOA
Company Labor Costs	\$ 1,225,987
Contract Costs	\$ 4,970,089
Material Costs	\$ 1,177,627
Other Direct Cost	\$ 5,231,923
Total Direct Costs	\$ 12,605,626
Total Indirect Costs	\$ 2,571,491
Total Loaded Costs	\$ 15,177,117

Pipeline Safety Enhancement Program Workpaper Supporting Chapter III
LINE 406 REPLACEMENT & HYDROTEST PROJECTS

The direct costs estimates broken out for Section 1, 2, 2A and 5 are shown in Table 4 below. An estimate was not prepared for Section 4.

Table 4: Stage 3 Direct Cost Estimate L-406

Cost Category	Section 1	Section 2 & 2A	Section 5	Stage 3 Estimate- 1, 2, 2A, 5
Company Labor Costs	\$ 299,297	\$ 314,834	\$ 124,994	\$ 739,125
Contract Costs	\$ 1,141,587	\$ 1,340,388	\$ 431,659	\$ 2,913,634
Material Costs	\$ 346,958	\$ 254,851	\$ 225,410	\$ 827,219
Other Direct Costs	\$ 1,265,393	\$ 1,564,116	\$ 533,888	\$ 3,363,397
Total Direct Costs	\$ 3,053,235	\$ 3,474,188	\$ 1,315,951	\$ 7,843,374
Total Indirect Costs	N/A	N/A	N/A	N/A
Total Loaded Costs	N/A	N/A	N/A	N/A

Pipeline Safety Enhancement Program Workpaper Supporting Chapter III LINE 406 REPLACEMENT & HYDROTEST PROJECTS

Stage 4 – Detailed Planning and Design and Procurement

During Stage 4, detailed design and material procurement was completed in order to provide a construction ready packet to the construction contractor to execute the planned project scope.

SoCalGas performed the following detailed engineering design and contractor selection actions to prepare for project construction:

- Progressed design drawings to an Issued for Construction (IFC) package.
- Acquired pothole information.
- Ordered the remaining material through PSEP Supply Management.
- Provided all required documentation in accordance with PSEP processes.

Detailed Planning and Design

At Stage 4, the scope for engineering design for this project remained unchanged from Stage 3 for the five sections that are the subject of this workpaper; however, Section 3 was re-scoped and became a separate project that will be submitted in a future reasonableness review application.

Construction Contractor Selection

Section 1, 2, 2A, and 5

Construction of L-406 Section 1, 2, 2A, and 5 was awarded to the Performance Partner.

Construction of L-406 Section 4 was included in the existing Pipeline Integrity ILI retrofit project; and therefore was excluded from the Performance Partner's scope of work for L-406.

The Performance Partner/Construction Contractor final TPE for Sections 1, 2, 2A and 5 was

██████████ which is ██████████ more than the Stage 3 construction contractor direct estimate of ██████████ that was used to develop the Phase 2 WOA estimate.

Pipeline Safety Enhancement Program Workpaper Supporting Chapter III
LINE 406 REPLACEMENT & HYDROTEST PROJECTS

Section 4

The construction contractor that was selected by Pipeline Integrity through a competitive bid process also completed Section 4 for PSEP.

Pipeline Safety Enhancement Program Workpaper Supporting Chapter III
LINE 406 REPLACEMENT & HYDROTEST PROJECTS

Stage 5 – Construction

Schedule

Section 1

Construction Start Date: 08/04/2014

NOP Date: 09/19/2014

Construction Finish Date: 01/09/2015

Construction duration was planned for 4 weeks and actual was 22 weeks.

Sections 2 and 2A

Construction Start Date: 10/20/2014

NOP Date: 12/13/2014

Construction Finish Date: 03/11/2015

Construction duration was planned for 4 weeks and actual was 17 weeks.

Section 4

Construction Start Date: 08/11/2014

NOP Date: 09/19/2014

Construction Finish Date: 09/23/2014

Construction duration was planned for 6 weeks and actual was 6 weeks.

Pipeline Safety Enhancement Program Workpaper Supporting Chapter III
LINE 406 REPLACEMENT & HYDROTEST PROJECTS

Section 5

Construction Start Date: 08/11/2015

NOP Date: 09/19/2014

Construction Finish Date: 09/24/2015

Construction duration was planned for 6 weeks and actual was 6 weeks.

Field Conditions

Section 1

Site Conditions:

- A steep incline and sandy terrain at the site location prevented the allotted 4,000-gallon water truck from covering all areas on site required for dust control, fire control, and mitigation efforts. A second water truck with necessary driving capabilities (6x6, 4 wheel drive) was needed to reach all areas of site location and achieve full coverage.
- Additional site security was needed for the construction areas due proximity to a highly populated location.

Constructability Issues:

- The original design called for a [REDACTED] test head assembly; however, a [REDACTED] test head was not available and a [REDACTED] test head assembly was used instead. Construction Contractor crews modified the test head launcher and receiver to accommodate the [REDACTED] test head, thus allowing de-water and pipe drying portion of the work to proceed on schedule.

Pipeline Safety Enhancement Program Workpaper Supporting Chapter III LINE 406 REPLACEMENT & HYDROTEST PROJECTS

Site Restoration:

- Trench excavation was more extensive than planned due to instability of the steep slope and poor soil conditions.
- After Section 1 work was completed, it was determined that additional land restoration was required because the amount of vegetation cleared was larger than planned to accommodate construction. Hydro-seeding and installation of erosion control took an additional 2 weeks to perform.

Sections 2 and 2A

Constructability Issues:

- A damaged portion of the pipeline was discovered when the pipe was exposed and needed to be replaced prior to strength testing. This resulted in lengthening the excavation to accommodate cutting out the damaged portion of the pipe.

Weather:

- Inclement weather resulted in delays in restoration, moving off of the laydown yard, and the repair of the access road.

Section 4

There was none of note.

Section 5

There was none of note.

Pipeline Safety Enhancement Program Workpaper Supporting Chapter III
LINE 406 REPLACEMENT & HYDROTEST PROJECTS

Figure 13: Exposed pipe on Section 5 with protective wrap in preparation for removal and asbestos abatement



Pipeline Safety Enhancement Program Workpaper Supporting Chapter III
LINE 406 REPLACEMENT & HYDROTEST PROJECTS

Stages 6 and 7 – Commissioning and Closeout

Commissioning activities included site restoration, final inspections, and placement of the pipeline back into service, transportation and disposal of the hydrotested water or hazardous material and demobilization from the site. Close out activities included development of final drawings, the reconciliation package and updates to company systems to reflect the changes made to the system.

Cost Variance

Table 5: L-406 Phase 2 WOA, Direct Estimate and Actual Costs

COST SUMMARY					
	PHASE 2 WOA	Estimate of Section 1, 2, 2A, 5	O&M (actuals)	CAPITAL (actuals)	Delta from Estimate over/(under) Difference between directs for sections worked as compared to actuals
COMPANY LABOR	\$ 1,225,987	\$ 739,125	\$ 96,786	\$ 296,763	\$ (345,576)
CONTRACT COSTS	\$ 4,970,089	\$ 2,913,634	\$ 1,985,423	\$ 3,871,332	\$ 2,943,121
MATERIALS	\$ 1,177,627	\$ 827,219	\$ 15,785	\$ 155,508	\$ (655,926)
OTHER DIRECTS	\$ 5,231,923	\$ 3,363,397	\$ 933,484	\$ 2,300,876	\$ (129,037)
TOTAL DIRECTS	\$ 12,605,626	\$ 7,843,375	\$ 3,031,477	\$ 6,624,480	\$ 1,812,582
INDIRECTS	\$ 2,571,491		\$ 188,662	\$ 630,833	
TOTAL LOADED	\$ 15,177,117		\$ 3,220,138	\$ 7,255,313	

Table 5 shows the Phase 2 WOA (Sections 1, 2, 2A, 3, and 5) estimate and the March 2016 loaded actual costs (Sections 1, 2, 2A, 4, and 5). As discussed above, the Phase 2 WOA includes the estimated costs for Section 3 that was later re-scoped from this project after the estimate was created. This table also compares the direct cost estimate for Sections 1, 2, 2A, and 5 and the direct actual costs for Sections 1, 2, 2A, 4 and 5. The difference between the direct cost estimate and the direct actual cost is \$1,812,582 for O&M and Capital.

The above variance is attributable to scope changes and unanticipated conditions that occurred after the Phase 2 WOA (including: incline and terrain necessitating a second water truck; modification to the test head launcher and receiver; extensive trench excavation; scope

Pipeline Safety Enhancement Program Workpaper Supporting Chapter III

LINE 406 REPLACEMENT & HYDROTEST PROJECTS

expansion to address damaged pipe; inclement weather; and additional site restoration work), an early cost estimating tool and process that was based on preliminary project designs (resulting in underestimation of construction contractor costs, inspection costs, and close out costs), and Pipeline Integrity handling the Section 4 replacement work (as a result, the Section 4 replacement was not included in the WOA estimate, but actuals of approximately \$354,000 are included). These increased costs were reasonably incurred to complete the project, but were not accounted for in the Stage 3 estimate.

Disallowances

There was no disallowance for line L-406 Replacement and Hydrotest Projects as there were no post-1955 segments included in the project without records that provide the minimum information to demonstrate compliance with industry standards or regulatory strength testing and recordkeeping requirements then applicable.

Pipeline Safety Enhancement Program Workpaper Supporting Chapter III
LINE 406 REPLACEMENT & HYDROTEST PROJECTS

Conclusion

SoCalGas and SDG&E enhanced the safety of their natural gas system by prudently executing the L-406 Hydrotest and Replacement Projects. Through this project, SoCalGas and SDG&E successfully replaced 1,000 feet of pipe and hydrotested over 1 mile of pipeline of L-406. The project incurred a total loaded project cost of \$ 10,475,451 for O&M and capital.

SoCalGas and SDG&E executed this project prudently: dividing the project into sections to better manage the planning and construction efforts and lessen customer impacts; engaging in prudent cost avoidance efforts; minimizing impacts to customers and the community; coordinating work with Pipeline Integrity; coordinating work across the different sections; and responding to unknown field conditions and scope changes.

SoCalGas and SDG&E's total loaded project cost of \$10,475,451 for O&M and capital is reasonable and should be approved. SoCalGas and SDG&E engaged in prudent cost avoidance efforts (reduced scope through scope validation efforts; realized efficiencies by accelerating a long stretch of Phase 2 pipe; expediting work to enable better coordination and improve efficiencies); engaged in reasonable efforts to promote competitive and market-based rates for contractor services and materials (see Chapter II (Phillips) (approximately 98% of PSEP agreements with contractors and suppliers were either competitively bid or through agreements entered into using market-based rates based on a recent competitive sourcing event)); and used a reasonable amount of company and contractor resources given the project's complexity (multiple projects across a large area – including populated areas requiring traffic control and additional site security – that required coordination within PSEP and with Pipeline Integrity; work on an incline with difficult terrain) and work scope changes (modification to the test head launcher and receiver; extensive trench excavation; scope expansion to address damaged pipe; and additional site restoration work).

**End of Line 406 Replacement (Sections 1, 2A, 4 and 5)
and Hydrotest (Section 2) Project Workpaper**

Pipeline Safety Enhancement Plan Workpaper Supporting Chapter III
LINE 407 HYDROTEST PROJECT

Summary

Table 1: L-407, Sections North & South Hydrotest Project Summary

Project Name	L-407 Hydrotest Project
WOA Number / Date	91053 & 25342 / January 31, 2014
City	Los Angeles
Original Pipe Diameter/New Diameter	██████████
Construction Start / Finish	March 27, 2014 / September 05, 2014
Loaded Capital Costs	\$ 536,711
Loaded O&M Costs	\$ 6,430,704
Total Loaded Project Costs	\$ 6,967,415
Disallowance	\$ 2,789 (O&M)

Description

Through the L-407, Sections North & South Hydrotest Project, SoCalGas and SDG&E enhanced their high-pressure transmission pipeline system by successfully pressure testing 2.998 miles of ██████████ diameter high-pressure transmission pipe, as shown in Figures 1-6 and Table 2 that describes the project scope as submitted in the 2011 PSEP filing and the final construction mileage.

Examples of cost avoidance actions included:

- Strategic placing of the test site of the North section to avoid environmentally sensitive areas and the increased cost of constructing on a steep hillside.
- The use of existing permits for the South section acquired by another SoCalGas and SDG&E department that allowed the work area to be in a location that did not require new permits from The Army Corps of Engineers, California Department of Fish and Wildlife, or the Regional Water Control Board.

Pipeline Safety Enhancement Plan Workpaper Supporting Chapter III
LINE 407 HYDROTEST PROJECT

Through scope validation efforts, SoCalGas and SDG&E reduced Category 4 Criteria scope mileage by over 4.5 miles.

Construction began in March 2014 and was completed in September 2014, incurring a total loaded project cost of \$6,967,415.

Pipeline Safety Enhancement Plan Workpaper Supporting Chapter III
LINE 407 HYDROTEST PROJECT

**Table 2: L-407, Sections North & South Hydrotest Project 2011 PSEP
Filing and Final Mileage***

Line 407 Section N & S	Total Mileage	Criteria Mileage	Accelerated Mileage**	Incidental Mileage
2011 PSEP Filing	6.300 mi.	6.251 mi.	0.049 mi.	0.000
Final Project Mileage				
Section North	2.699 mi.	0.878 mi.	1.788 mi.	176 ft.
Section South	0.298 mi.	840 ft.	703 ft.	32 ft.
Total	2.997 mi.	1.037 mi.	1.921 mi.	208 ft.

*Values may not add to total due to rounding.

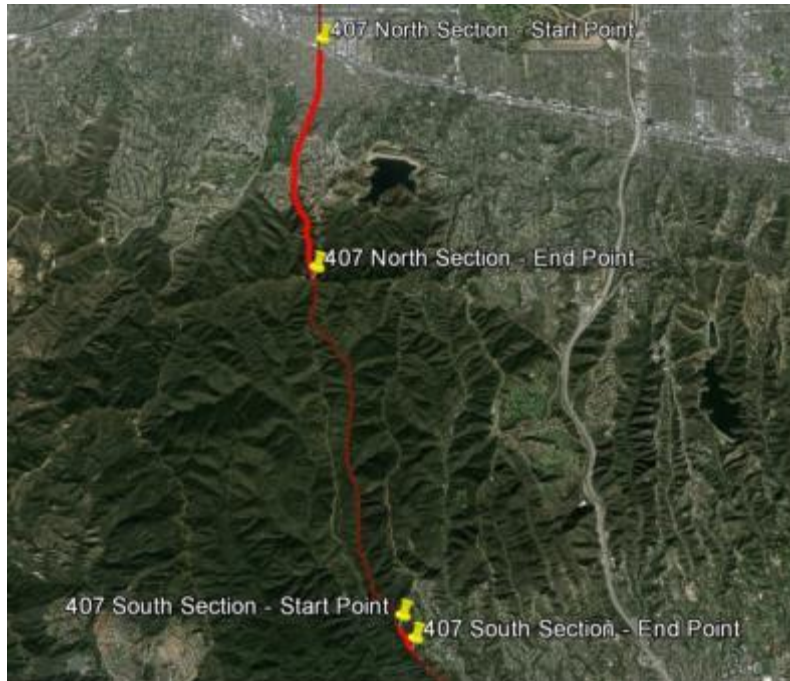
**Accelerated mileage includes Phase 1B and Phase 2 pipe. Phase 2 includes pipelines without sufficient record of a pressure test in less populated areas (Phase 2A) or pipelines with record of a pressure test, but without record of a pressure test to modern – Subpart J – standards (Phase 2B). Included in this project were 0.761 miles of pipe accelerated from Phase 2A and 1.160 miles of pipe accelerated from Phase 2B. The accelerated mileage was included to realize efficiencies and to enhance project constructability

Pipeline Safety Enhancement Plan Workpaper Supporting Chapter III
LINE 407 HYDROTEST PROJECT

Figure 1: Overview Map of L-407 Hydrotest – North & South Sections



Figure 2: Satellite Image of L-407 Hydrotest – North & South Sections

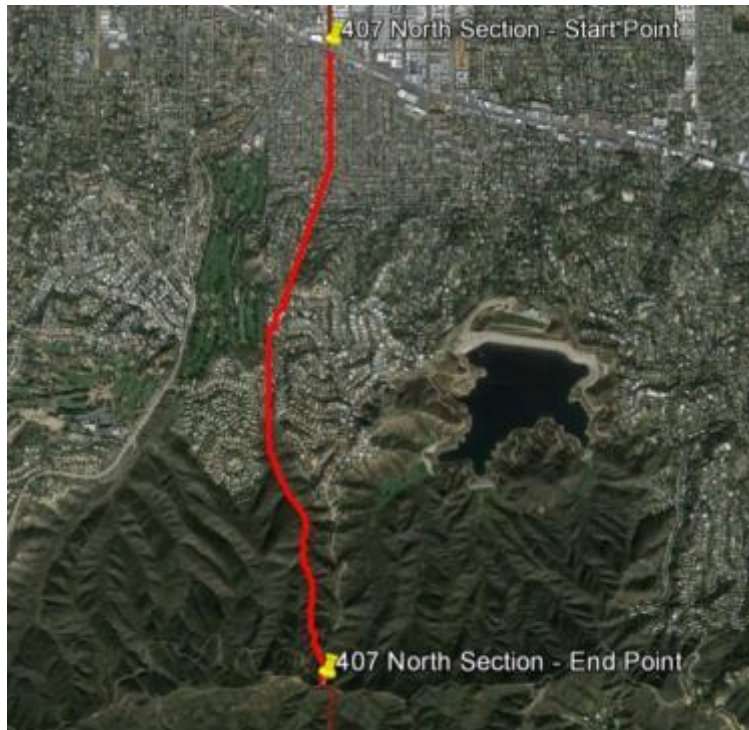


Pipeline Safety Enhancement Plan Workpaper Supporting Chapter III
LINE 407 HYDROTEST PROJECT

Figure 3: Overview Map of L-407 Hydrotest – North Section



Figure 4: Satellite Image of L-407 Hydrotest North Section



Pipeline Safety Enhancement Plan Workpaper Supporting Chapter III
LINE 407 HYDROTEST PROJECT

Stage 1 – Project Initiation

In workpapers supporting the 2011 PSEP filing,¹ SoCalGas and SDG&E identified L-407 as a hydrotest project. L-407 is approximately 12 miles of high pressure transmission pipeline comprising mostly of [REDACTED] diameter pipe. This pipeline extends from Encino to Los Angeles and is mostly 1951 vintage.

During Stage 1, SoCalGas and SDG&E completed the scope validation and verified that:

- At the time of the 2011 PSEP filing, the project comprised 6.3 miles of Category 4 pipe.
- In 1955, a large section of L-407 was hydrotested along Lindley Ave, in between Burbank Blvd and Boris Dr. in Encino, including sections of L-407 in other populated areas.
- L-407 is primarily classified as Class 3 in Encino and Los Angeles, and Class 1 through the Santa Monica Mountains.
- A 4-mile section of L-407 runs through the Santa Monica Mountains and does not have sufficient record of a pressure test. This section of L-407 will be remediated in Phase 2.

Upon completion of the Stage 1 scope validation, SoCalGas and SDG&E modified the scope of this project. Category 4 (Criteria) mileage was reduced from 6.251 miles to 1.498 miles, and Category 4 Non-Criteria (accelerated) mileage was reduced from 259 feet to 132 feet accordingly.

¹ See December 2, 2011 Amended Pipeline Safety Enhancement Plan (PSEP) of SoCalGas and SDG&E.

Pipeline Safety Enhancement Plan Workpaper Supporting Chapter III
LINE 407 HYDROTEST PROJECT

Stage 2 – Analysis and Findings

During Stage 2, data analysis was performed and the findings were used to define project scope and to plan tasks for later stages of the project.

The findings were used to re-scope the project for constructability purposes, dividing the project into two sections and adding a combined total of 4.052 incidental and accelerated miles.

Engineering Factors

L-407 sections North and South were scoped as hydrotests because they were greater than 1,000 feet, had manageable customer impacts and had no engineering factors supporting replacement.

North Section

SoCalGas and SDG&E increased the section to be hydrotested, adding 1.888 miles to the North Section.

On the southern end of the North Section, 0.697 miles of accelerated pipe were added because the Category 4 section ended on a steep hillside and the terrain would involve the removal of trees to level out a work area, which would then require restoration to its original condition. This would add time and cost to the schedule to secure environmental permits and complete the associated remediation. A suitable location for staging equipment was found about a half mile south at Mulholland Drive which mitigated these risks and reduced community impacts.

On the northern end, 1.191 miles of accelerated miles were added because the Category 4 mileage ended in a congested residential neighborhood and the area had insufficient space for staging water tanks. The nearest location that had the needed amount of space to house large water tanks was acquired about 1 mile away. Therefore, incidental mileage was added to minimize disruption to the residents.

Pipeline Safety Enhancement Plan Workpaper Supporting Chapter III
LINE 407 HYDROTEST PROJECT

South Section

SoCalGas and SDG&E increased the section to be hydrotested, adding 2.163 miles to the South Section.

On the northern end of the South Section, 0.133 miles of accelerated pipe was added because another SoCalGas and SDG&E department had existing permits inside Sullivan Canyon. Designing the project to use this location for the work area meant that PSEP would not require new permits from The Army Corps of Engineers, California Department of Fish and Wildlife, or the Regional Water Quality Control Board and therefore could start the project sooner.

On the southern end, 2.030 miles of accelerated pipe was added because the Category 4 mileage ended in a difficult area with limited space for staging water tanks. Where the south test endpoint was extended to San Vicente Blvd. San Vicente Blvd was considered because of work space and to include Phase 2b accelerated mileage. The driver to include this scope changed at the end of Stage 3 and there was a reduction in accelerated miles.

Additional Considerations

Potential project risks that could affect or delay the project were determined to be:

- Flash floods in Sullivan Canyon.

Pipeline Safety Enhancement Plan Workpaper Supporting Chapter III
LINE 407 HYDROTEST PROJECT

Stage 3 – Initial Planning and Design

During Stage 3, SoCalGas and SDG&E developed a Phase 2 WOA estimate, and began field surveys to complete preliminary design drawings and further refine scope.

In addition to the schedule and estimate, other key activities include identifying permits, TRES, and easements, defining long lead materials and pricing, understanding customer impacts and interruptions, and preparing any necessary environmental submittals.

Planning and Design Activity

Assumptions included in the initial engineering design:

- Hydrotesting of 2.779 miles of [REDACTED] pipe for the North Section and 2.771 miles of [REDACTED] pipe for the South Section.
- The hydrotest for both the North and South Sections will entail a total of four small sections of pipe that will be removed to install test heads.
- Two days for mobilization and two days for demobilization.
- Day work will be performed as much as possible. If necessary, night work will occur during the water fill, dewater, hydrotest, and tie-in days. To limit the line outage duration, these operations must be completed once they have started.
- All taps within the test section will be disconnected before hydrotesting. Taps will be reconnected after a successful hydrotest.
- The mileage for the south section was decreased from 2.771 miles to 0.298 miles because the original design posed a variety of challenges:

Pipeline Safety Enhancement Plan Workpaper Supporting Chapter III
LINE 407 HYDROTEST PROJECT

- Staging the hydrotest water tanks along the center median on San Vicente Blvd would impair motorist visibility, and delay traffic on a heavily trafficked boulevard, thus increasing safety concerns.
- A likely delay in acquiring permits could delay construction start date.
- A known Holiday moratorium risked demobilization of the contractor and remobilization after the Holiday moratorium.

Additional Considerations

- It is assumed that there will be noise complaints from the public due to this project which will require risk mitigation by maximizing daytime work and performing community outreach to notify public about project.
- Nesting birds in Sullivan Canyon could require risk mitigation by performing field surveys before mobilization and having daily monitoring from certified biologist, and may cause a delay to accommodate.
- Holiday moratorium could prevent lane closures in the City of Los Angeles; therefore, work on Ventura Blvd and San Vicente Blvd may need to be delayed during the Holiday season.
- City of LA traffic control plans are considered a long lead permit and need to be submitted months in advance of the work.
- Work areas on Mulholland Drive and Sullivan Canyon would need to be minimized to keep walking trails open to the public.
- Work areas on W. Ventura Blvd and San Vicente Blvd are being considered to maximize space for water storage tanks for hydrotesting. The work areas also require access to city hydrants and city sewers for water acquisition and disposal.

Pipeline Safety Enhancement Plan Workpaper Supporting Chapter III
LINE 407 HYDROTEST PROJECT

Cost Avoidance

- The North test site was strategically placed to avoid environmentally sensitive areas to avoid the increased costs associated with constructing on a steep hillside.
- It was determined that another SoCalGas and SDG&E department had existing permits for L-407 South section. Designing the project to use this location for the work area meant that PSEP would not require new permits from The Army Corps of Engineers, California Department of Fish and Wildlife, or the Regional Water Quality Control Board and therefore could start the project sooner.

Estimate of Costs

The Phase 2 WOA estimate for both the North and South Sections of L-407 was \$7,010,952 and was based on preliminary design. This estimate was prepared in January 2014 using the Stage 3 SCG Pipeline Estimate Template Rev 0 estimating tool and is based on preliminary design work. Actual costs from L-2000-A were used whenever possible. Note: this WOA was developed later in the design process after the scope changed for the South Section.

Table 3: L-407, Sections North & South Hydrotest Project Phase 2 WOA Estimate

Cost Category	Phase 2 WOA
Company Labor Costs	\$ 483,891
Contract Costs	\$ 4,742,966
Material Costs	\$ 176,712
Other Direct Costs	\$ 711,787
Total Direct Costs	\$ 6,115,356
Total Indirect Costs	\$ 895,596
Total Loaded Costs	\$ 7,010,952

Pipeline Safety Enhancement Plan Workpaper Supporting Chapter III
LINE 407 HYDROTEST PROJECT

Stage 4 – Detailed Engineering Design and Procurement

During Stage 4, detailed design and material procurement was completed in order to provide a construction ready packet to the construction contractor to execute the planned project scope. The scope changes that occurred during this stage are described below.

Detailed Planning and Design

North Section

The North Section mileage was shortened after negotiations to obtain a TRE agreement with the property owners to use their parking lot for water storage tanks were unsuccessful. The property owners denied the request based on a planned development project that was in conflict with the hydrotest project schedule. The hydrotest starting point was moved 502 feet south to a nearby frontage road on W Ventura Blvd and Lindley Ave. This new work area was smaller (potentially increasing logistical concerns – see Figure 7), but was able to maintain minimal disruption to the residents and provide adequate space for both hydrotest equipment and water storage tanks.

Potential project risks that could impact scope or schedule were identified and mitigated. Noise complaints were reduced by maximizing daytime work and notifying the neighbors about the project schedule and activities.

Pipeline Safety Enhancement Plan Workpaper Supporting Chapter III
LINE 407 HYDROTEST PROJECT

Figure 7: L-407 North Section work area showing Baker Tanks with sound proofing



South Section

There were no scope changes from Stage 3 to Stage 4.

Potential project risks that could impact scope or schedule were identified and mitigated:

- Impact to public use of Sullivan Canyon hiking trail.
- Risk mitigation was implemented to maximize daytime work and perform community outreach to notify public about the project. This included keeping the hiking trail open, except for the hydrotest day, posting signage and notifying the public of the hiking trail closure date.

Pipeline Safety Enhancement Plan Workpaper Supporting Chapter III

LINE 407 HYDROTEST PROJECT

- Bird nesting season required a pre-mobilization survey of the construction area which found no bird nests that could delay the project and increase costs. This risk required a full time biologist on site during construction activities.

Additional considerations

- Work areas in the Sullivan Canyon were selected to maximize space for water storage tanks used for hydrotesting. The work area required access to city hydrants and city sewers for water acquisition and disposal.

Construction Contractor Selection

North Section

Construction of the North Section started before the PSEP Performance Partnership Program was established; therefore, the construction contractor was selected through a competitive fixed-bid process.

The Construction Contractor's final bid was \$ [REDACTED], which is \$ [REDACTED] less than the Stage 3 construction contractor direct estimate of \$ [REDACTED] that was used to develop the Phase 2 WOA.

South Section

Construction of the South Section started after the PSEP Performance Partnership Program was established; therefore, the construction contract was assigned to a Performance Partner.

The Performance Partner's TPE was \$ [REDACTED], which is \$ [REDACTED] less than the Stage 3 construction contractor direct estimate of \$ [REDACTED] that was used to develop the Phase 2 WOA.

Pipeline Safety Enhancement Plan Workpaper Supporting Chapter III
LINE 407 HYDROTEST PROJECT

Stage 5 – Construction

Schedule

North Section

Construction Start Date: 03/27/2014

NOP Date: 04/30/2014

Construction Finish Date: 05/14/2014

The construction lasted 6 weeks instead of the planned 7 weeks because of the need to dewater the pipeline in a shorter time period to minimize the time water would be in the pipe after hydrotest. The permit to discharge water into the sewer severely limited the discharge rate, which would have caused water to be in the pipe too long, potentially causing corrosion. This required a change in dewatering procedures. This change shortened the construction schedule by one week. The accelerated dewatering would have created complications stemming from the Los Angeles Bureau of Sanitation's limited sewer discharge rate. As a result, the shortened time period necessitated the need for vacuum trucks which were used to dewater the pipeline expeditiously. The trucks then hauled the water to a water treatment facility. Additionally, in order to discharge the water from the line in the shortened time period, the construction crew worked overtime.

The North Section was successfully hydrotested on April, 24, 2014.

South Section

Construction Start Date: 07/07/2014

NOP Date: 08/20/2014

Construction Finish Date: 09/05/2014

The hydrotest was completed as planned within 8 weeks.

The South Section was successfully hydrotested on August 12, 2014.

Pipeline Safety Enhancement Plan Workpaper Supporting Chapter III
LINE 407 HYDROTEST PROJECT

Field Conditions

Conditions were encountered in the field that were not anticipated during design and planning that had to be addressed or mitigated. Listed below is a summary of the key field changes broken down by type of change for these sections:

North Section

Substructures:

- While excavating on Mulholland Drive, an oil line was discovered closer to the pipe than expected. To prevent damage to the oil line, the test head was moved above ground.

Constructability Issues:

- To ensure safety for the public, an additional 240 feet of k-rail with plywood was installed on top as required.
- A [REDACTED] pipe support on another company pipeline, exposed during excavation at Mulholland Drive, required replacement for integrity reasons.

Permit Conditions:

- Limited discharge rate allowed by the sewer discharge permit necessitated vacuum trucks and schedule adjustments.

Site Restoration:

- During construction the City inspector mandated grinding of asphalt to recess plates. Also potholes were required to be grinded and repaved.
- Coating damage was discovered by the inspection team. Repairs were made as a standard practice to protect the SoCalGas pipeline.

Pipeline Safety Enhancement Plan Workpaper Supporting Chapter III
LINE 407 HYDROTEST PROJECT

South Section

Site Preparation/Restoration:

- Tree trimming was required to stage equipment for hydrotest.
- Overtime was required to expedite backfilling of the north excavation of the South Section because the on-site District Operations representative instructed the contractor to backfill the excavation before an upcoming agency visit.

Pipeline Safety Enhancement Plan Workpaper Supporting Chapter III
LINE 407 HYDROTEST PROJECT

Stages 6 and 7 – Commissioning and Closeout

Commissioning activities included site restoration, final inspections, and placement of the pipeline back into service, transportation and disposal of the hydrotested water or hazardous material and demobilization from the site. Close out activities included development of final drawings, the reconciliation package and updates to company systems to reflect the changes made to the system.

Cost Variance

Table 4: L-407, Sections North & South Hydrotest Project Phase 2 WOA Estimate and Actual Costs

COST SUMMARY					
	PHASE 2 WOA	O&M (actuals)	CAPITAL (actuals)	DELTA over/(under)	
COMPANY LABOR	\$ 483,891	\$ 465,439	\$ 23,830	\$ 5,378	
CONTRACT COSTS	\$ 4,742,966	\$ 2,870,116	\$ 248,393	\$ (1,624,456)	
MATERIALS	\$ 176,712	\$ 113,291	\$ 39,491	\$ (23,931)	
OTHER DIRECTS	\$ 711,787	\$ 2,468,097	\$ 179,176	\$ 1,935,485	
INDIRECTS	\$ 895,596	\$ 513,761	\$ 45,821	\$ (336,014)	
TOTAL LOADED	\$ 7,010,952	\$ 6,430,704	\$ 536,711	\$ (43,538)	

Table 4 compares the Phase 2 WOA estimate and the March 2016 total loaded actual costs. The estimate at the end of Stage 3 was \$7,010,952. The project incurred total loaded actual cost of \$6,967,415 for O&M and capital. The actual cost incurred to complete the L-407, Sections North & South Hydrotest Project was less than the Stage 3 estimate by \$43,538. This project includes \$536,711 capital for 4 tie-in pieces which totaled 70 feet of pipe.

Disallowances

For this hydrotest project, SoCalGas and SDG&E have identified pipe as being installed post 1961 and lacking records that provide the minimum information to demonstrate compliance with industry standards or regulatory strength testing and recordkeeping requirements then applicable. Of the 3 miles of pipeline that was pressure tested, 7 feet (0.043%) of accelerated

Pipeline Safety Enhancement Plan Workpaper Supporting Chapter III
LINE 407 HYDROTEST PROJECT

pipe is disallowed. Therefore, \$2,789 (0.043%) of the total project O&M costs are disallowed from recovery.

Pipeline Safety Enhancement Plan Workpaper Supporting Chapter III
LINE 407 HYDROTEST PROJECT

Conclusion

SoCalGas and SDG&E enhanced the safety of their natural gas system by prudently executing the L-407, Sections North & South Hydrotest Project. Through this project, SoCalGas and SDG&E successfully hydrotested 2.998 miles of Line 407. The project incurred a total loaded project cost of \$6,967,415 for O&M and capital.

SoCalGas and SDG&E executed this project prudently: engaging in prudent cost avoidance efforts; leveraging prior SoCalGas and SDG&E permit acquisition efforts; dividing the project into sections for constructability purposes; designing the North Section to avoid steep hillside, difficult terrain, a nearby congested residential neighborhood, and provide a suitable location for staging equipment; minimizing impacts to customers and the community; and responding to unknown field conditions and scope changes.

SoCalGas and SDG&E's total loaded project cost of \$6,967,415 for O&M and capital is reasonable and should be approved (minus acknowledged disallowances). SoCalGas and SDG&E engaged in prudent cost avoidance efforts (strategic placing of the North test site to avoid environmentally sensitive areas and the increased cost of constructing on a steep hillside; using Army Corps of Engineers, California Department of Fish and Wildlife, and Regional Water Control Board permits acquired by another SoCalGas and SDG&E department; and reducing project scope through scope validation efforts); engaged in reasonable efforts to promote competitive and market-based rates for contractor services and materials (see Chapter II (Phillips) (approximately 98% of PSEP agreements with contractors and suppliers were either competitively bid or through agreements entered into using market-based rates based on a recent competitive sourcing event)); and used a reasonable amount of company and contractor resources given the project's complexity (work in the Santa Monica Mountains and nearby residential areas) and work scope changes (see above).

Pipeline Safety Enhancement Plan Workpaper Supporting Chapter III
LINE 41-30-A REPLACEMENT PROJECT

Summary

Table 1: SL-41-30-A Replacement Project Summary

Project Name	SL-41-30-A Replacement Project
WOA Number/ WOA Date	82059 / July 9, 2014
City	Ontario
Original Pipe Diameter/ New Pipe Diameter	██████████
Construction Start/ Construction Finish	July 29, 2014 / September 3, 2014
Loaded Capital Costs	\$ 483,725
Loaded O&M Costs	\$ 0
Total Loaded Project Costs	\$ 483,725
Disallowance	\$ 0

Description

Through the SL- 41-30-A Replacement Project, SoCalGas and SDG&E enhanced its high pressure pipeline system by successfully replacing 107 feet of high-pressure, ██████████ diameter pipe in the city of Ontario, as shown in Figures 1 and 2 and Table 2 that describes the project scope as submitted in the 2011 PSEP filing and the final mileage.

Examples of cost avoidance actions included:

- Scope validation resulted in a reduction of Category 4 Criteria mileage from 1,368 feet described in the 2011 PSEP filing to 100 feet.
- Installed ██████████ pipe rather than replace kind-for-kind with ██████████ pipe due to engineering analysis findings.
- Determined that some of the Category 4 pipe could be removed from PSEP’s scope based on information from a pipe material test.

Construction began in July 2014 and was completed in September 2014. The project incurred a total loaded project cost of \$483,725.

Pipeline Safety Enhancement Plan Workpaper Supporting Chapter III
LINE 41-30-A REPLACEMENT PROJECT

Table 2: SL-41-30-A 2011 PSEP Filing and Final Mileage*

Line 41-30-A	Total Mileage	Criteria Mileage	Accelerated Mileage	Incidental Mileage
2011 PSEP Filing	0.259 mi.	0.259 mi.	0	0
Total	107 ft.	100 ft.	0	7 ft.

** Values may not add to total due to rounding.*

Pipeline Safety Enhancement Plan Workpaper Supporting Chapter III
LINE 41-30-A REPLACEMENT PROJECT

Figure 1: Overview Map of SL-41-30-A

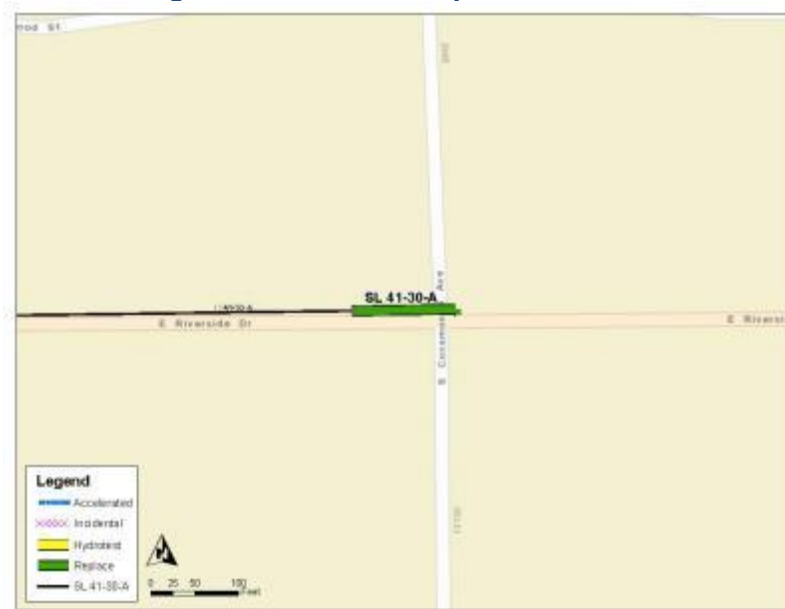


Figure 2: Satellite Image of SL-41-30-A



Pipeline Safety Enhancement Plan Workpaper Supporting Chapter III
LINE 41-30-A REPLACEMENT PROJECT

Stages 1 & 2 – Project Initiation / Analysis and Findings

In Workpapers supporting the 2011 PSEP filing,¹ SoCalGas and SDG&E identified the SL-41-30-A with 0.259 miles of Category 4 Criteria pipe as a Phase 1A replacement project. The pipeline is located in the City of Ontario.

The PSEP Organization was not yet fully functional at the initiation of this project. As a result, the project was planned and executed by the SoCalGas Distribution Organization.

Additionally, the project was initiated before the implementation of the formal PSEP Seven Stage Review Process and was accordingly not subject to that process. Rather, a similar decision methodology was employed that incorporated many of the same attributes and goals that form the foundation for the Seven Stage Review Process.

Engineering Factors

SoCalGas and SDG&E completed scope validation confirming that SL-41-30-A was installed in 1940 with modifications made between 1951 and 1953. It was also determined that an additional 7 feet of incidental pipe was required to eliminate an existing weld that was too close to the tie-in point.

SoCalGas took pipe coupon samples of SL-41-30-A that updated the pipe grade and wall thickness for 1,265 feet of [REDACTED] pipe installed under the original work order. These updates reduced the SMYS of the [REDACTED] pipe to a less than 20% MAOP, thereby removing it from

¹ See December 2, 2011 Amended Pipeline Safety Enhancement Plan (PSEP).

Pipeline Safety Enhancement Plan Workpaper Supporting Chapter III
LINE 41-30-A REPLACEMENT PROJECT

PSEP's scope. As a result, the scope was reduced from 1,365 feet to 100 feet. The remaining 100 feet involved [REDACTED] pipe with different attributes and it remained in scope.

SoCalGas and SDG&E performed a PSEP Decision Tree analysis of SL-41-30-A. The PSEP Decision Tree directs that projects less than 1,000 feet should be replaced because under most circumstances it is the cost effective option. In this instance, no conditions justified overriding this guidance.

Pipeline Safety Enhancement Plan Workpaper Supporting Chapter III
LINE 41-30-A REPLACEMENT PROJECT

Stage 3 & 4 – Initial Planning, Detailed Engineering Design and Procurement

During Stages 3 and 4, SoCalGas and SDG&E completed detailed engineering design work and contractor selection. The SoCalGas Distribution Operating Regions designed and managed the project. The material requirements and the project cost estimate were determined by the planner representing the operating district.

There were no scope changes between stages 3 and 4.

Planning and Design Activity

- Replacement of approximately 107 feet of [REDACTED] pipe.
- One mobilization and demobilization.
- Normal daylight work hours and a 5-day work week.

Cost Avoidance

Followed RER recommendation to install [REDACTED] pipe rather than replace kind for kind with [REDACTED] pipe.

Estimate of Costs

This estimate was prepared using the SoCalGas Distribution Operating Regions' Construction Management System (CMS). The estimated total loaded installed cost for the pipeline project was calculated to be \$329,540, as shown in Table 3, and based on preliminary designs. This project cost estimate was prepared by the planner representing the operating district and incorporated the RER recommendation to install [REDACTED] pipe.

Pipeline Safety Enhancement Plan Workpaper Supporting Chapter III
LINE 41-30-A REPLACEMENT PROJECT

Table 3: SL-41-30-A Phase 2 WOA Estimate

Cost Category	Phase 2 WOA
Company Labor Costs	\$31,630
Contract Costs	\$218,624
Material Costs	\$13,176
Other Direct Costs	\$17,890
Total Direct Costs	\$281,320
Total Indirect Costs	\$48,220
Total Loaded Costs	\$329,540

Construction Contractor Selection

SoCalGas’ Distribution Operating Region had previously selected a Single Source contractor from a competitively bid Master Service Agreement (MSA) to perform work for the region. PSEP used the same contractor at comparable rates to complete this project.

The Construction Contractor’s estimate for time and material was \$ [REDACTED], which was \$ [REDACTED] more than the Construction Management System’s direct estimate of \$ [REDACTED] that was used to develop the Phase 2 WOA estimate.

Pipeline Safety Enhancement Plan Workpaper Supporting Chapter III
LINE 41-30-A REPLACEMENT PROJECT

Stage 5 – Construction

Schedule

Construction Start Date: 07/29/2014

NOP Date: 08/13/2014

Construction Finish Date: 09/03/2014

Field Conditions

There were no unanticipated field conditions.

Pipeline Safety Enhancement Plan Workpaper Supporting Chapter III
LINE 41-30-A REPLACEMENT PROJECT

Stages 6 and 7 – Commissioning and Closeout

Commissioning activities included site restoration, final inspections, and placement of the pipeline back into service, transportation and disposal of the hydrotested water or hazardous material and demobilization from the site. Close out activities included development of final drawings, the reconciliation package and updates to company systems to reflect the changes made to the system.

Cost Variance

Table 4: SL-41-30 A Phase 2 WOA Estimate and Actual Costs

COST SUMMARY				
	PHASE 2 WOA	CAPITAL (actuals)	DELTA over/(under)	
COMPANY LABOR	\$ 31,630	\$ 33,456	\$	1,826
CONTRACT COSTS	\$ 218,624	\$ 267,773	\$	49,149
MATERIALS	\$ 13,176	\$ 14,479	\$	1,303
OTHER DIRECTS	\$ 17,890	\$ 113,769	\$	95,879
INDIRECTS	\$ 48,220	\$ 54,248	\$	6,028
TOTAL LOADED	\$ 329,540	\$ 483,725	\$	154,185

Table 4 compares the Phase 2 WOA estimate and the March 2016 loaded actual costs. The loaded actual costs exceeded the Phase 2 WOA estimate by \$154,185. The WOA estimate was calculated using the SoCalGas Distribution Organization’s estimating tool, CMS.

The above variance is attributable to the SoCalGas Distribution Organization’s estimating tool, CMS tool underestimating construction costs, inspections costs, and project support costs. These increased costs were reasonably incurred to complete the project, but were not accounted for in the initial estimate.

Disallowances

There was no disallowance for line SL-41-30 Replacement as there were no post-1955 segments included in the project without records that provide the minimum information to demonstrate compliance with industry standards or regulatory strength testing and recordkeeping requirements then applicable.

Pipeline Safety Enhancement Plan Workpaper Supporting Chapter III
LINE 41-30-A REPLACEMENT PROJECT

Conclusion

SoCalGas and SDG&E successfully and prudently executed the SL-41-30-A Replacement Project. Through this replacement project, SoCalGas and SDG&E successfully replaced 107 feet of pipe in August 2014. The project incurred a total loaded project cost of \$483,725.

SoCalGas and SDG&E executed this project prudently: engaging in prudent cost avoidance efforts and executing the project using the SoCalGas Distribution Organization so as to complete the work as soon as practicable.

SoCalGas and SDG&E's total loaded project cost of \$483,725 is reasonable and should be approved. SoCalGas and SDG&E engaged in prudent cost avoidance efforts (installed a [REDACTED] pipe rather than replace in kind with a [REDACTED] pipe and engaged in coupon cut analysis to reduce the project scope); engaged in reasonable efforts to promote competitive and market-based rates for contractor services and materials (see Chapter II (Phillips) (approximately 98% of PSEP agreements with contractors and suppliers were either competitively bid or through agreements entered into using market-based rates based on a recent competitive sourcing event)); and used a reasonable amount of company and contractor resources given the project's complexity (work in a city street in a residential area).

End of SL-41-30A Replacement Project Workpaper

Pipeline Safety Enhancement Plan Workpaper Supporting Chapter III
LINE 45-120 SECTION 1 REPLACEMENT PROJECT

Summary

Table 1: SL-45-120 Section 1 Replacement Project Summary

Project Name	SL-45-120 Section 1 Replacement Project
WOA Number / WOA Date	82054 / December 10, 2013
City	Santa Clarita
Original Pipe Diameter / New Pipe Diameter	██████████
Construction Start / Construction Finish	March 19, 2014 / July 19, 2014
Loaded Capital Costs	\$ 6,418,206
Loaded O&M Costs	\$ 0
Total Loaded Project Costs	\$ 6,418,206
Disallowance	\$ 0

Description

Through the SL-45-120 Section 1 Replacement Project, SoCalGas and SDG&E enhanced its high pressure transmission pipeline system by successfully replacing 0.553 miles of mostly 1930 vintage high-pressure, ██████████ diameter pipe with ██████████ diameter pipe in the city of Santa Clarita, as shown in Figures 1 and 2 and Table 2 that describes the project scope as submitted in the 2011 PSEP filing and the final construction as-built mileage.

Examples of cost avoidance actions included:

- Scope validation reduced Category 4 Criteria mileage by approximately 1.2 miles.
- SoCalGas and SDG&E scheduled the project prior to the City of Santa Clarita’s paving moratorium which would have delayed the project to 2020 or caused increased costs with excessive permitting re-paving requirements.
- Unbolting and removing the pipe versus fabricating, resulted in a more cost effective process.

Pipeline Safety Enhancement Plan Workpaper Supporting Chapter III
LINE 45-120 SECTION 1 REPLACEMENT PROJECT

Construction began in March 2014 and was completed in July 2014. The SL-45-120 Section 1 Replacement Project incurred a total loaded project cost of \$6,418,206.

Table 2: SL-45-120 Section 1 - 2011 PSEP Filing and Final Mileage*

Line 45-120 Section 1	Total Mileage	Criteria Mileage	Accelerated Mileage	Incidental Mileage
2011 PSEP Filing (all sections)	4.301	1.772	2.529	0
Total	0.553	0.533	0	0.021

**Values may not add to total due to rounding.*

Pipeline Safety Enhancement Plan Workpaper Supporting Chapter III
LINE 45-120 SECTION 1 REPLACEMENT PROJECT

Figure 1: Overview Map of SL-45-120 Section 1 Replacement Project



Figure 2: Satellite Image of SL-45-120 Section 1 Replacement Project



Pipeline Safety Enhancement Plan Workpaper Supporting Chapter III
LINE 45-120 SECTION 1 REPLACEMENT PROJECT

Stage 1 – Project Initiation

In workpapers supporting the 2011 PSEP filing,¹ SoCalGas and SDG&E identified the SL-45-120 Project as a Phase 1A replacement project. The proposed scope was to replace 4.301 miles of primarily [REDACTED] diameter high-pressure pipe that runs through the city of Santa Clarita.

During Stage 1, SoCalGas and SDG&E scope validation confirmed that the pipeline was first installed in 1930.

¹ See December 2, 2011 Amended Pipeline Safety Enhancement Plan (PSEP) of SoCalGas and SDG&E.

Pipeline Safety Enhancement Plan Workpaper Supporting Chapter III

LINE 45-120 SECTION 1 REPLACEMENT PROJECT

Stage 2 – Analysis and Findings

During Stage 2, data analysis was performed and the findings were used to define project scope and to plan tasks for later stages of the SL-45-120 Project.

Engineering Factors

SoCalGas and SDG&E decided to split SL-45-120 into three separate sections: 1, 2, and 3. The City of Santa Clarita was planning to enact a 2015 paving moratorium along Newhall Ave. that would have prevented future work until 2020, thus resulting in a very narrow window in which to work in this area. Engineering design and construction for Section 1 could be expedited ahead of the other two sections before the moratorium date, whereas in-depth engineering analysis of Sections 2 and 3 could be conducted on its own timeline because these sections were not affected by the moratorium.

SoCalGas and SDG&E determined through scope validation that Category 4 Criteria mileage should be reduced. SL 45-120 Section 1 required additional incidental mileage to accommodate the tie-ins.

Pipeline Safety Enhancement Plan Workpaper Supporting Chapter III
LINE 45-120 SECTION 1 REPLACEMENT PROJECT

Stage 3 – Initial Planning and Design

During Stage 3, SoCalGas and SDG&E developed a Phase 2 WOA estimate, and began field surveys to complete preliminary design drawings and further refine scope.

In addition to the schedule and estimate, other key activities include identifying all permits, TRE's, and easements, defining long lead materials and pricing, understanding customer impacts and interruptions, and preparing any necessary environmental submittals.

Planning and Design Activity

It was determined that a 55 foot portion of pipe at the west end of SL-45-120 and not in the original scope of Section 1, was initially determined to have been installed in the 1990s, in fact installed in the 1930s. This additional footage required the project design to add 55 ft extending the replacement into Newhall Station.

Design assumptions included:

- One mobilization and demobilization.
- No work area restrictions.
- Day work only.

All utilities and foreign substructures along the proposed alignment had been identified.

Environmental costs assumed one full-time monitor on site at all times and the laboratory costs were based on previous sampling events. The planned environmental permit was planned for 10 weeks.

Additional Considerations

An existing regulator station feeds a large number of customers which are served by SL-45-120 Section 1. As a result, a temporary regulator station was planned to be used.

Pipeline Safety Enhancement Plan Workpaper Supporting Chapter III
LINE 45-120 SECTION 1 REPLACEMENT PROJECT

Local water district projects' construction schedules would be coordinated around SL- 45-120 construction schedule.

Cost Avoidance

The project team saved time and effort by removing and unbolting the pipe as this process is faster to perform and can be executed more cost efficiently than fabricating.

Estimate of Costs

The estimated total cost for the 2,875 feet of [REDACTED] pipe was \$6,604,816 as shown in Table 3, and is based on preliminary designs. This estimate was prepared in November 2013 using the Stage 3 SCG Pipeline Estimate Template Rev 0 tool.

Table 3: SL-45-120 Section 1 Phase 2 WOA Estimate

Cost Category	Phase 2 WOA
Company Labor Costs	\$ 457,302
Contract Costs	\$ 0
Material Costs	\$ 600,348
Other Direct Costs	\$ 4,367,630
Total Direct Costs	\$ 5,425,280
Total Indirect Costs	\$ 1,179,536
Total Loaded Costs	\$ 6,604,816

Pipeline Safety Enhancement Plan Workpaper Supporting Chapter III
LINE 45-120 SECTION 1 REPLACEMENT PROJECT

Stage 4 – Detailed Engineering Design and Procurement

During Stage 4, detailed design and material procurement was completed in order to provide a construction ready packet to the construction contractor to execute the planned project scope.

Detailed Planning and Design

Due to field verification of piping an increase of 9 feet of incidental pipe was incorporated into the design.

Construction Contractor Selection

Construction of SL-45-120, Section 1 Project started before the PSEP Performance Partner Program was established. The construction contractor was selected through a competitive solicitation process. Six qualified contractors participated in the solicitation. A contractor was selected based on price, schedule, work experience, and commercial factors.

The Construction Contractor's bid was \$ [REDACTED], which is \$ [REDACTED] less than the Stage 3 construction contractor direct estimate of \$ [REDACTED] that was used to develop the Phase 2 WOA estimate.

Pipeline Safety Enhancement Plan Workpaper Supporting Chapter III
LINE 45-120 SECTION 1 REPLACEMENT PROJECT

Stage 5 – Construction

Schedule

Construction Start Date: 03/19/2014

NOP Date: 07/13/2014

Construction Finish Date: 07/19/2014

Field Conditions

Conditions were encountered in the field that were not anticipated during design and planning that had to be addressed or mitigated. Listed below is a summary of the key field changes broken down by type of change for this project:

Substructure:

- Several unknown utilities were encountered within the alignment of the project. As a result, SoCalGas made several realignments. Included in the unknown utilities were an abandoned water line and a false trench line (non-native soil) around a storm drain. These conflicts caused modifications and pipe footage changes to be made to alignment and installation activities which also impacted the schedule.

Permit Conditions:

- The City of Santa Clarita inspector restricted the working area to 500 feet of plating at a time. This unanticipated restriction increased construction duration. The City of Santa Clarita also added restrictions to work hours, requiring night work for certain portions of the project. Night work decreased productivity because of limited visibility.

Pipeline Safety Enhancement Plan Workpaper Supporting Chapter III
LINE 45-120 SECTION 1 REPLACEMENT PROJECT

Utility Coordination:

- It was assumed that SoCalGas would not be in conflict with other agencies' projects. However, the City of Santa Clarita was coordinating work for many utilities in the area. As a result, activities previously planned to be executed in parallel were no longer feasible because of the city's direction and this ultimately impacted the construction schedule.

Pipeline Safety Enhancement Plan Workpaper Supporting Chapter III
LINE 45-120 SECTION 1 REPLACEMENT PROJECT

Stages 6 and 7 – Commissioning and Closeout

Commissioning activities included site restoration, final inspections, and placement of the pipeline back into service, transportation and disposal of the hydrotested water or hazardous material and demobilization from the site. Close out activities included development of final drawings, the reconciliation package and updates to company systems to reflect the changes made to the system.

Cost Variance

Table 4: SL-45-120 Section 1 Phase 2 WOA Estimate and Actual Costs

COST SUMMARY				
	PHASE 2 WOA	CAPITAL (actuals)	DELTA over/(under)	
COMPANY LABOR	\$ 457,302	\$ 344,913	\$	(112,389)
CONTRACT COSTS	\$ -	\$ 3,330,827	\$	3,330,827
MATERIALS	\$ 600,348	\$ 342,446	\$	(257,902)
OTHER DIRECTS	\$ 4,367,630	\$ 1,799,314	\$	(2,568,316)
INDIRECTS	\$ 1,179,536	\$ 600,706	\$	(578,830)
TOTAL LOADED	\$ 6,604,816	\$ 6,418,206	\$	(186,610)

Table 4 compares the Phase 2 WOA estimate and the March 2016 total loaded actual costs. Despite scope increases resulting in approximately \$213,827 in costs as discussed earlier in this workpaper, the SL-45-120 Section 1 Project resulted in total loaded actual costs that were \$186,610 less than the Phase 2 WOA estimate. Regardless of the estimate’s accuracy, it should be noted that SoCalGas and SDG&E did still experience numerous scope changes and unanticipated conditions that occurred after the Phase 2 WOA estimate (including: increased project scope due to field verification efforts; identification of unknown utility substructures requiring realignments; additional permitting requirements; and coordinating work with other utilities).

Pipeline Safety Enhancement Plan Workpaper Supporting Chapter III
LINE 45-120 SECTION 1 REPLACEMENT PROJECT

Disallowances

There was no disallowance for L-45-120 Section 1 replacement project as there were no post 1955 segments included in the project without records that provide the minimum information to demonstrate compliance with industry standards or regulatory strength testing and recordkeeping requirements then applicable.

Pipeline Safety Enhancement Plan Workpaper Supporting Chapter III

LINE 45-120 SECTION 1 REPLACEMENT PROJECT

Conclusion

SoCalGas and SDG&E enhanced the safety of their natural gas system by prudently executing the SL-45-120 Section 1 Replacement Project. Through this replacement project, SoCalGas and SDG&E successfully replaced 0.553 miles of pipe of varying diameter in the city of Santa Clarita. The project incurred a total loaded project cost of \$6,418,206.

SoCalGas and SDG&E executed this project prudently: engaging in prudent cost avoidance efforts; performing work on an accelerated schedule to avoid a City-imposed paving moratorium; designing the project to be performed expeditiously and cost efficiently; and responding prudently to scope changes and field conditions.

SoCalGas and SDG&E's total loaded project cost of \$ 6,418,206 is reasonable and should be approved. SoCalGas and SDG&E engaged in prudent cost avoidance efforts (scope validation resulted in scope reduction; working around a City-imposed paving moratorium to avoid delay and additional costs; and designing the project to allow for a more cost effective tie-in); engaged in reasonable efforts to promote competitive and market-based rates for contractor services and materials (see Chapter II (Phillips) (approximately 98% of PSEP agreements with contractors and suppliers were either competitively bid or through agreements entered into using market-based rates based on a recent competitive sourcing event)); and used a reasonable amount of company and contractor resources given the project's complexity (work in populated areas, in a regulator station that feeds a large number of customers, and work that required coordination with other agency projects) and work scope changes (increased scope of work, additional permitting requirements, unknown utility substructures, and coordinating work with other utilities).

End of SL-45-120 Section 1 Replacement Project Workpaper

Pipeline Safety Enhancement Program Workpaper Supporting Chapter III
LINE 45-120XO1 REPLACEMENT PROJECT

Summary

Table 1: SL- 45-120XO1 Replacement Project Summary

Project Name	SL-45-120XO1 Replacement Project
WOA Number / Date	26198 / September 3, 2013
City	Santa Clarita
Original Pipe Diameter/New Diameter	██████████
Construction Start / Finish	September 9, 2013 / October 4, 2013
Loaded Capital Costs	\$ 0
Loaded O&M Costs	\$ 857,395
Total Loaded Project Costs	\$ 857,395 ¹
Disallowance	\$ 0

Background

Of the projects identified as PSEP projects in the 2011 filing, SoCalGas and SDG&E ultimately identified two projects within the Newhall Station as PSEP Phase 1A projects: SL-45-120XO1² and SL-45-120. A third project, Line 85 South,³ was originally identified as a Phase 1B project and connects to SL-45-120 and SL-45-120XO1 at the Newhall Station. SL-85 S was later determined to have some HCA segments that qualified it as a Phase 1A project. SL-45-120XO1 was finished in October of 2013. The execution of two Newhall Station projects after SL-45-120XO1 resulted in the abandonment of SL-45-120XO1. The abandonment of SL-45-120XO1 was prudent because it enabled the abandonment of Category 4 Criteria mileage on L-85 South, and also allowed for the relocation of a valve from under the street into the station, and provided for a more efficient design of the later projects.

¹ Because SL- 45-120XO1 was later abandoned, the costs associated with this replacement project have been classified as O&M.

² The Phase 1 WOA for L-45-120XO1 was initiated on October 12, 2012.

³ The Phase 1 WOA for L-85 South was initiated on September 18, 2014.

Pipeline Safety Enhancement Program Workpaper Supporting Chapter III

LINE 45-120XO1 REPLACEMENT PROJECT

In an effort to address projects as soon as practicable SoCalGas and SDG&E parceled out pipeline to different teams. The teams could not start planning on all projects at the same time. The precise limits of the work to be done on the pipelines are not determined until Stage 3 (Planning). The later projects did not know that their project would impact the earlier projects. The Appendix to this workpaper provides a detailed account of the timing and rationale that led ultimately to the abandonment of SL-45-120XO1.

Description

Through the SL-45-120XO1 Replacement Project, SoCalGas and SDG&E successfully replaced 57 feet of high-pressure, [REDACTED] diameter pipe with [REDACTED] diameter pipe, as shown in Figures 1 and 2 and Table 2 that describes the project scope as submitted in the 2011 PSEP filing and the final mileage.

Examples of cost avoidance actions for this project included:

- Tested pipe in the yard rather than at the site in order to increase construction efficiency thus avoiding traffic control costs and costs to bring test heads above ground.
- Removed and replaced the pipe in the same trench versus the more expensive option to reroute this short pipeline.

Construction on SL- 45-120XO1 began in September 2013 and was completed in October 2013, incurring a total loaded project cost of \$857,395.

Pipeline Safety Enhancement Program Workpaper Supporting Chapter III
LINE 45-120XO1 REPLACEMENT PROJECT

Table 2: SL-45-120XO1 2011 PSEP and Final Mileage*

Line 45-120XO1	Total Mileage	Criteria Mileage	Accelerated Mileage	Incidental Mileage
2011 PSEP Filing	0.008 mi	0.002 mi	0.006 mi	0
Total	57 ft. ⁴	50 ft.	0	7 ft.

*Values may not add to total due to rounding.

⁴ Of the 57 feet of pipe replaced as part of SL- 45-120XO1 Replacement project, 12 feet are part of SL-45-120. Actual footage replaced on SL- 45-120XO1 is 45 feet.

Pipeline Safety Enhancement Program Workpaper Supporting Chapter III

LINE 45-120XO1 REPLACEMENT PROJECT

Figure 1: Overview Map of SL-45-120XO1 Replacement Project

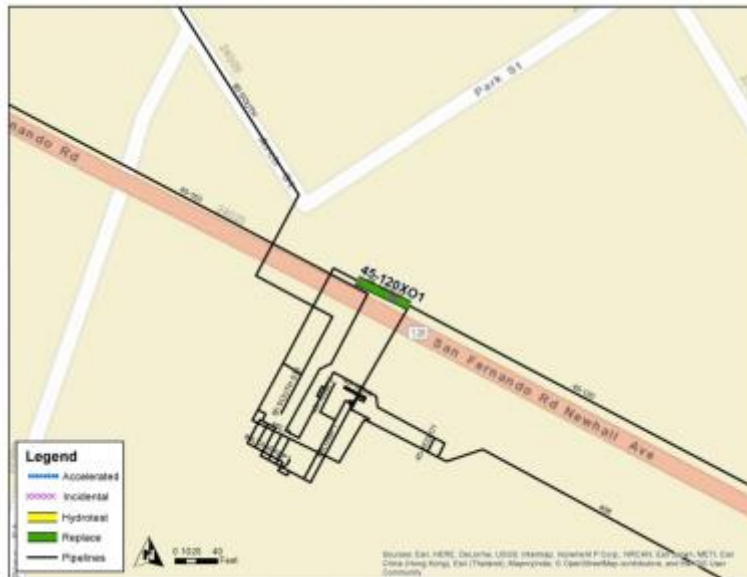


Figure 2: Satellite Image of SL-45-120XO1 Replacement Project



Pipeline Safety Enhancement Program Workpaper Supporting Chapter III

LINE 45-120X01 REPLACEMENT PROJECT

Stage 1 and 2 – Project Initiation, Analysis and Findings

In order to begin PSEP work as soon as practicable, PSEP identified SL-45-120X01 as a short segment project which could be executed immediately. Because the PSEP Organization was not yet fully up and running at the initiation of this project the project was planned and executed by the region (SoCalGas Distribution Organization). Additionally, this project was initiated before the implementation of the formal PSEP Seven Stage Review Process and was not subject to that process. Rather, a similar decision methodology was employed that incorporated many of the same attributes and goals that form the foundation for the Seven Stage Review Process. For this project, activity associated with Stages 1 and 2 were combined into one stage.

In workpapers supporting the 2011 PSEP filing,⁵ SoCalGas and SDG&E identified the SL-45-120X01 Project as a Phase 1A replacement project. The proposed scope was 41 feet of primarily [REDACTED] diameter high-pressure pipe. The pipeline is located in the city of Santa Clarita.

During Stages 1 and 2, scope validation confirmed that the pipeline was installed in 1930. There were no changes to the filed scope in Stages 1 and 2, except a reclassification of 5 feet from accelerated to incidental.

Engineering Factors

A PSEP Decision Tree analysis of SL-45-120X01 confirmed that the project design should commence as a replacement project because SL-45-120X01 scope was less than 1,000 feet. The PSEP Decision Tree directs that scope less than 1,000 feet should be replaced because

⁵ See December 2, 2011 Amended Pipeline Safety Enhancement Plan.

Pipeline Safety Enhancement Program Workpaper Supporting Chapter III
LINE 45-120X01 REPLACEMENT PROJECT

under most circumstances, it is the cost effective option. In this instance, there were no conditions that justified overriding this guidance.

Pipeline Safety Enhancement Program Workpaper Supporting Chapter III

LINE 45-120XO1 REPLACEMENT PROJECT

Stages 3 and 4 – Initial Planning and Design; Detailed Engineering Design and Procurement

Planning and Design Activity

During the initial detailed planning, the SoCalGas Distribution Organization designed and managed the project. The material requirements and the project cost estimate were determined by the planner representing the operating district.

The findings included in the initial planning and design was as follows:

- Request for Engineering Review analysis revealed that a [REDACTED] bypass connected to a [REDACTED] temporary regulator station was required to serve a pressure district during tie-ins in order to continue service to core customers.
- An encroachment permit was procured from the City of Santa Clarita, requiring all street work to be done at night between 8:30pm and 4:30am (8 hours).

Total length increased in Stage 3 by 10 feet because:

- Criteria mileage increased a net of 29 feet
 - Added 6 feet to encompass additional Criteria footage.
 - Added 27 feet to encompass additional Criteria footage that was original identified as accelerated.
 - Removed 4 feet from scope because pipe was operating at <20% SMYS.
- Accelerated mileage decreased a net of 21 feet
 - Removed 27 feet due to class location update and re-classification as Criteria mileage.
 - Added 6 feet of SL-45-120 for constructability reasons.
- Incidental mileage had an additional 2 feet added for constructability reasons.

Pipeline Safety Enhancement Program Workpaper Supporting Chapter III
LINE 45-120XO1 REPLACEMENT PROJECT

Estimate of Costs

The preliminary estimated total loaded cost for the 42 feet was \$540,712, as shown in Table 3, and is based on preliminary designs. This estimate was prepared using the SoCalGas Distribution Operating Regions’ Construction Management System (CMS). This estimate was updated just prior to construction to \$941,629 in a reauthorized WOA to account primarily for construction costs.

Table 3: SL-45-120XO1 Phase 2 WOA Estimate

Cost Category	Phase 2 WOA 10/22/12	Reauthorized WOA 9/3/13
Company Labor Costs	\$ 7,765	\$100,657
Contract Costs	\$272,076	\$582,320
Material Costs	\$ 39,969	\$ 63,279
Other Direct Costs	\$ 69,569	\$ 69,569
Total Direct Costs	\$389,380	\$815,825
Total Indirect Costs	\$151,332	\$125,804
Total Loaded Costs	\$540,712	\$941,629

Construction Contractor Selection

The project was opened to competitive bidding by approved construction contractors. The successful contractor was selected and awarded based on schedule and cost considerations.

The construction contractor’s fixed bid was [REDACTED] which was [REDACTED] more than the Stage 3 construction contract direct estimate of [REDACTED] that was used to develop the Phase 2 WOA.

Pipeline Safety Enhancement Program Workpaper Supporting Chapter III
LINE 45-120XO1 REPLACEMENT PROJECT

Stage 5 – Construction

Schedule

Construction Start Date:	09/09/2013
NOP Date:	09/28/2013
Construction Finish Date:	10/04/2013

Field Conditions

Conditions were encountered in the field that were not anticipated during design and planning that had to be addressed or mitigated. The following conditions impacted the project scope and schedule:

Site Conditions:

- Additional time and equipment were required to complete excavation because the construction area was composed of two-sack slurry rather than sand.

Permitting Issues:

- The City of Santa Clarita required additional repairs to paving/asphalt.

Constructability:

- Tie-in was planned to be a 12-hour hot tie-in but took 34 hours to complete because the ██████ section of pipe could not be joined by a butt weld because of alignment issues. As a result the fit up took much longer than planned.

Twelve feet of accelerated Category 4 Criteria pipe was added to the overall SL-45-120XO1 scope for constructability purposes. SL-45-120XO1 ends in a tee and tie-ing in to a tee is problematic. Therefore a new tee with pre-welded short sections of pipe on all three legs of the tee was used, creating an additional 12 feet of pipeline..

Pipeline Safety Enhancement Program Workpaper Supporting Chapter III
LINE 45-120XO1 REPLACEMENT PROJECT

Stages 6 and 7 – Commissioning and Closeout

Commissioning activities included site restoration, final inspections, and placement of the pipeline back into service. SoCalGas and SDG&E removed the bypass and temporary regulator station from Newhall Station and switched over the feed to the regulator station from the temporary bypass to the permanent feed.

Cost Variance

Table 4: SL- 45-120XO1 Phase 2 WOA Estimate and Actual Costs

COST SUMMARY				
	PHASE 2 WOA	O&M (actuals)	DELTA over/(under)	
COMPANY LABOR	\$ 100,657	\$ 84,087	\$	(16,570)
CONTRACT COSTS	\$ 582,320	\$ 552,664	\$	(29,656)
MATERIALS	\$ 63,279	\$ 53,860	\$	(9,419)
OTHER DIRECTS	\$ 69,569	\$ 85,692	\$	16,123
INDIRECTS	\$ 125,804	\$ 81,093	\$	(44,711)
TOTAL LOADED	\$ 941,629	\$ 857,395	\$	(84,234)

Table 4 compares the Reauthorized WOA estimate and the March 2016 total loaded actual costs. The reauthorized estimate was calculated in Stage 4 using the Distribution Operating Regions' Construction Management System (CMS), after the construction contractor bid was received. The total loaded actual costs of \$857,395 were \$84,234 less than the reauthorized estimate. It should be noted that the above estimate did not include Stage 5 scope changes (including: construction area was composed of two-sack slurry rather than sand; permit required additional repairs and paving; a vacuum truck was put on standby for hydrotest mitigation; and the use of wedding bands to complete the tie-in).

Disallowances

There was no disallowance for the Line 45-120XO1 Replacement Project as there were no post 1955 segments included in the project without records that provide the minimum information to

Pipeline Safety Enhancement Program Workpaper Supporting Chapter III
LINE 45-120X01 REPLACEMENT PROJECT

demonstrate compliance with industry standards or regulatory strength testing and recordkeeping requirements then applicable.

Pipeline Safety Enhancement Program Workpaper Supporting Chapter III

LINE 45-120XO1 REPLACEMENT PROJECT

Conclusion

SoCalGas and SDG&E enhanced the safety of their natural gas system by prudently executing the 45-120XO1 Replacement Project. Through this replacement project, SoCalGas and SDG&E successfully replaced 57 feet of pipe of varying diameter in the city of Santa Clarita. The project incurred a total loaded project cost of \$857,395.

SoCalGas and SDG&E executed this project prudently: engaging in prudent cost avoidance efforts; executing the project using the SoCalGas Distribution Organization so as to complete the work as soon as practicable; minimizing customer impacts; and responding to field conditions and scope changes. Additionally, as explain in the Appendix, the abandonment of SL- 45-120XO1 was prudent because it enabled the abandonment of Category 4 Criteria mileage on Line 85 S, allowed for the relocation of a valve under the street and into the station, and provided for a more efficient design of the later projects.

SoCalGas and SDG&E's total loaded project cost of \$857,395 is reasonable and should be approved. SoCalGas and SDG&E engaged in prudent cost avoidance efforts (testing the replacement pipe in the yard rather than at the site; and removed and replaced the pipe in the same trench instead of rerouting the pipe); engaged in reasonable efforts to promote competitive and market-based rates for contractor services and materials (see Chapter II (Phillips) (approximately 98% PSEP agreements with contractors and suppliers were either competitively bid or through agreements entered into using market-based rates based on a recent competitive sourcing event)); and used a reasonable amount of company and contractor resources given the project's complexity (work in a city street at night) and work scope changes (construction area was composed of two-sack slurry rather than sand; permit required additional repairs and paving; and longer than expected tie-in operations).

Pipeline Safety Enhancement Program Workpaper Supporting Chapter III
LINE 45-120XO1 REPLACEMENT PROJECT

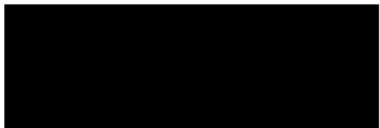
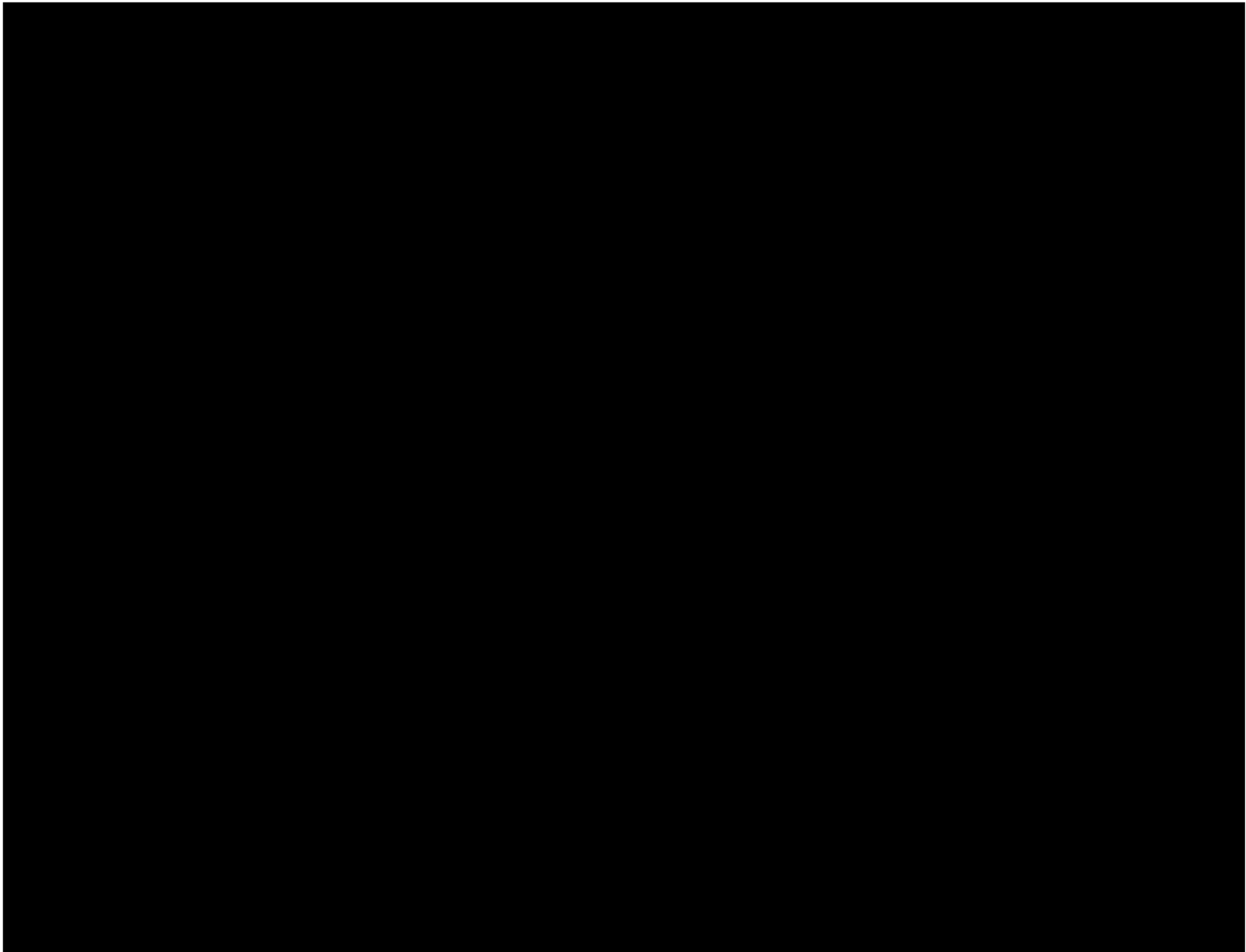
APPENDIX – SL-45-120XO1

Newhall Station: Lines 45-120XO1, 45-120, 85 South

As mentioned, SL- 45-120 and Line 85 are connected to either end of SL- 45-120XO1, and both lines had PSEP Criteria pipe adjacent to SL- 45-120XO1. As part of the SL- 45-120 and Line 85 PSEP work, SL- 45-120XO1 was abandoned to be sure to replace all Criteria pipeline.

Ultimately, this resulted in a safer and more effective design and relocation of a valve from under the street to inside the station.

Figure 3: Before and After Line 45-120XO1 Replacement (in-place), 2013 **CONFIDENTIAL**



Pipeline Safety Enhancement Program Workpaper Supporting Chapter III

LINE 45-120XO1 REPLACEMENT PROJECT

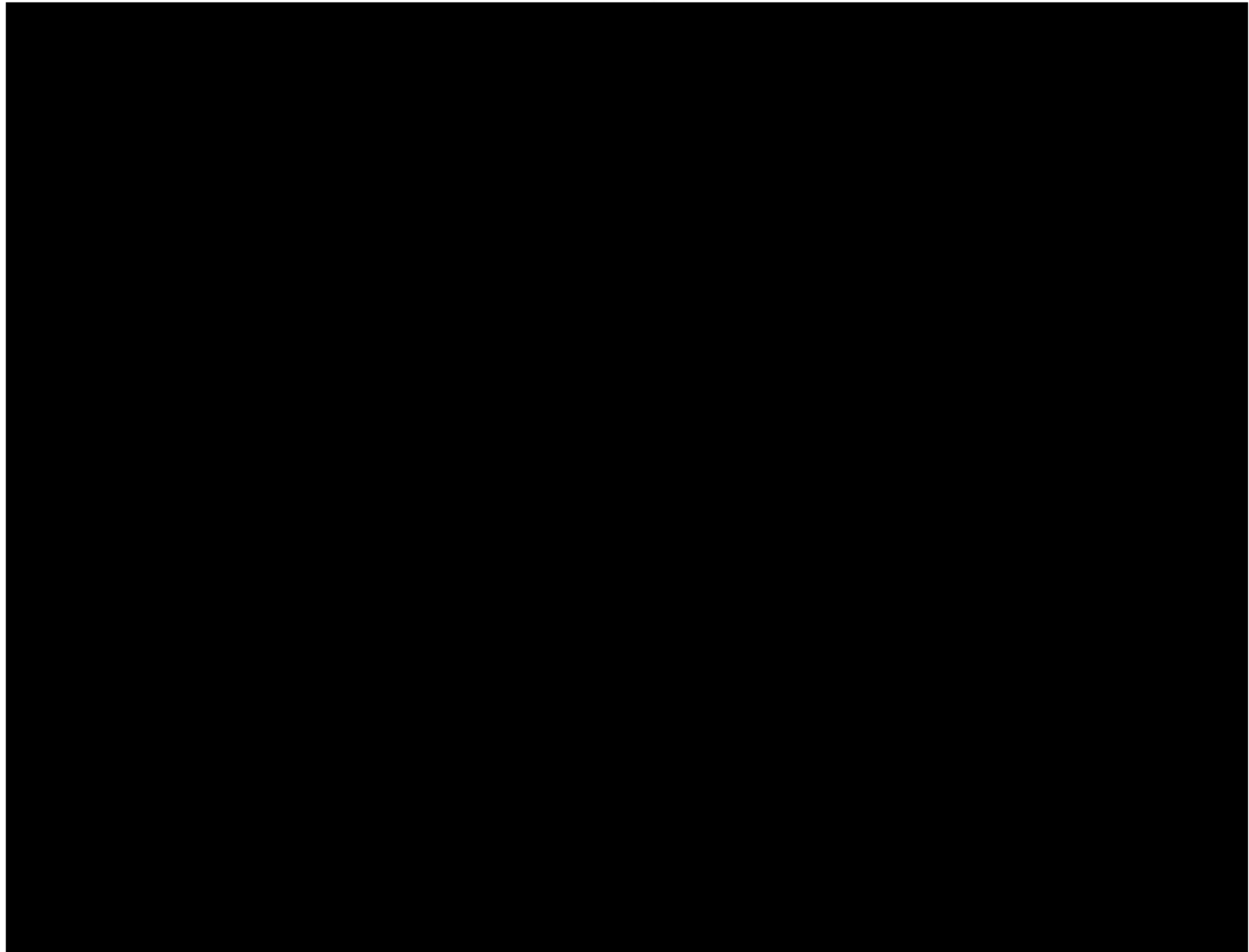
Line 45-120

Line 45-120 is a 5-mile pipeline that begins at Newhall Station. As the PSEP organization ramped up, the project team initiated a project to address Line 45-120. During Stage 1, the pipeline was reviewed for sufficient records of a pressure test. As the Line 45-120 project progressed into Stage 2, the PSEP project team determined, in accordance with the PSEP Decision Tree, that the 1930-vintage, non-piggable pipe should be replaced. During the Stage 3 design phase, in June 2013, it was determined that a segment of Line 45-120 without sufficient record of a pressure test abutted the pipe that was part of the Line 45-120XO1 replacement project.

The team designed the replacement pipe to lie in an alternate space beneath the street surface that was offset by 27.5 feet from the location of the existing Line 45-120 pipeline. The original Line 45-120 was planned to be abandoned and left in place under the street. Given the length of the pipeline segment to be addressed, this was less expensive than removing and replacing pipeline in the same location. In addition, there were operating limitations on the amount of time the line could be removed from service; therefore, replacing by an offset avoided removal of the existing pipeline from service for the length of time required to replace in-place. In order to tie the newly installed pipeline into the existing line, an “S” configuration was designed to route the new Line 45-120 pipe over the 27.5 feet to Line 45-120XO1. Additionally, the design needed to be tied in directly to a pipeline that extends out of Newhall Station. Because of this design requirement, 46 feet of the Line 45-120XO1 project installed in 2013 was abandoned. The alternative to not abandoning any of the 2013 pipe would have been to design a tie-in further to the east, resulting in a higher cost because a greater length of tie-over pipe and a more complicated design would be required to avoid conflicts with other underground utilities. This project was placed in service in July 2014.

Pipeline Safety Enhancement Program Workpaper Supporting Chapter III
LINE 45-120XO1 REPLACEMENT PROJECT

Figure 4: After Line 45-120 Construction, 2014 **CONFIDENTIAL**



Line 85 South

Line 85 terminates in Newhall Station, a location where multiple pipelines come together. As is common in pipeline stations, complicated piping connects various pipelines to allow for normal or emergency flow among pipelines in Newhall station. In August 2014, the PSEP team initiated a project to address Line 85. During the Stage 1 review, the team reviewed pipeline records to determine pipe segments without sufficient evidence of a pressure test to at least 1.25 x MAOP. In researching the various pipelines within Newhall station, the project team determined that a 91-foot segment of pipe on Line 85 lacked sufficient records of a pressure test to at least 1.25 x

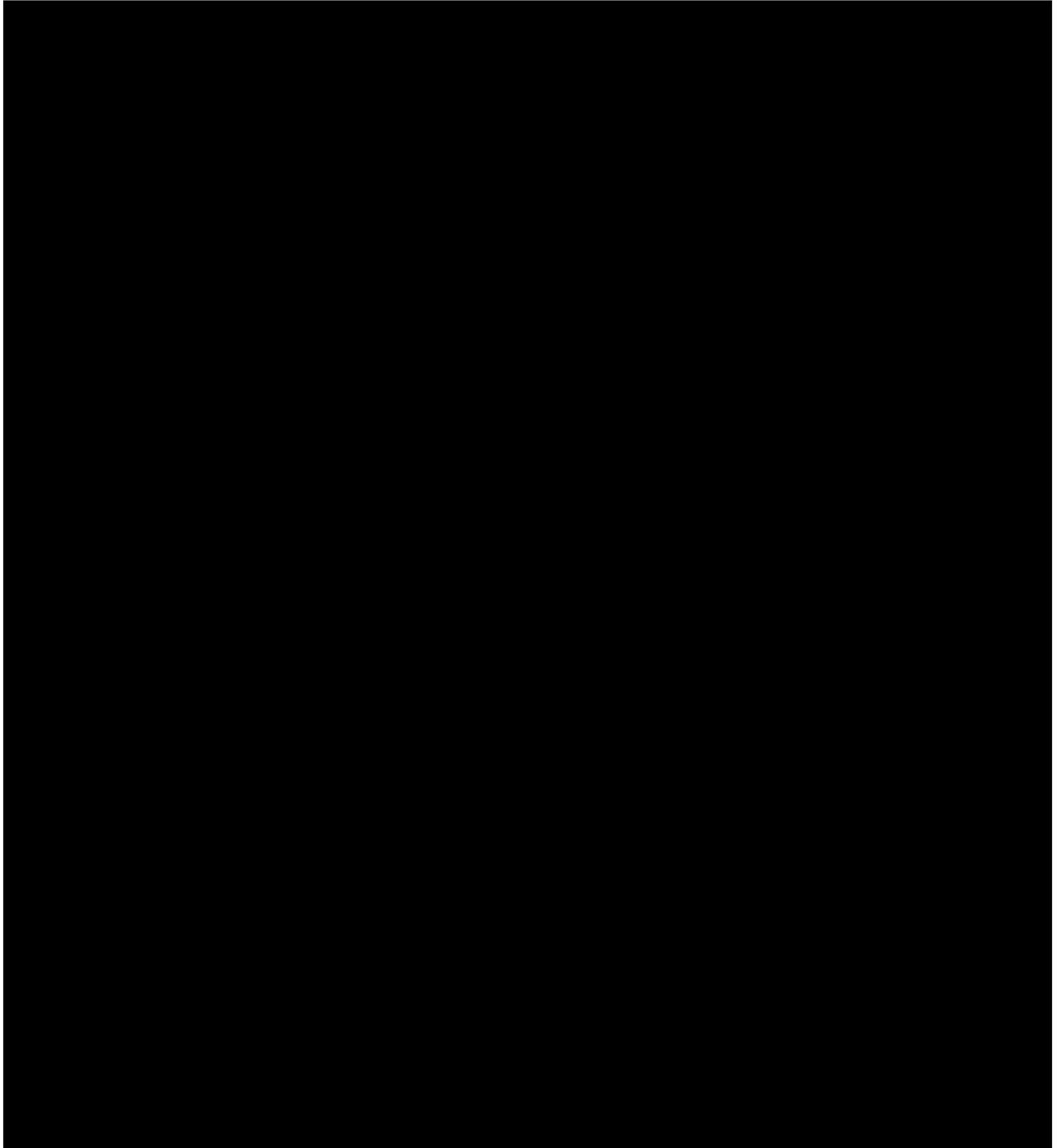
Pipeline Safety Enhancement Program Workpaper Supporting Chapter III
LINE 45-120XO1 REPLACEMENT PROJECT

MAOP. This pipe segment connected to Line 45-120XO1. Further research showed that an additional 312 feet of station piping was also without sufficient record of a pressure test.

As the team planned how best to address the 91-foot section of pipe and the other segments of station piping, a plan was developed that would have the beneficial results of eliminating the pipe that was without sufficient records of a pressure test and moving a valve from the street outside Newhall Station (refer to Figures 5 and 6) to within the station. This design resulted in completing the abandonment of Line 45-120XO1 and a portion of Line 85. This new design, while calling for abandonment of the recently installed segment of Line 45-120XO1, resulted in a safer design by placing the valve inside the station and out of the street.

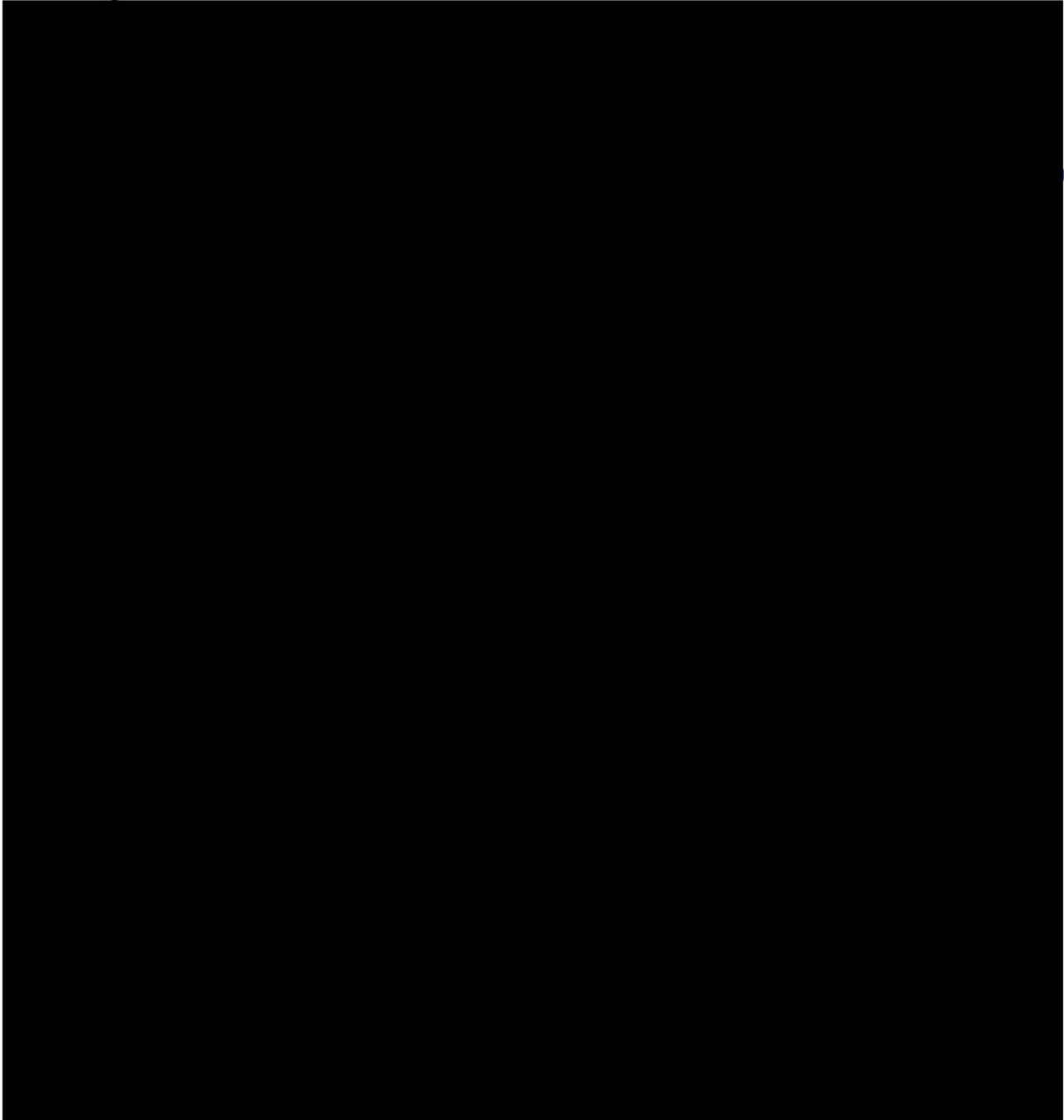
Pipeline Safety Enhancement Program Workpaper Supporting Chapter III
LINE 45-120X01 REPLACEMENT PROJECT

Figure 5: Before Line 85 South Construction, 2015 **CONFIDENTIAL (Revised)**



Pipeline Safety Enhancement Program Workpaper Supporting Chapter III
LINE 45-120X01 REPLACEMENT PROJECT

Figure 6: After Line 85 South Construction, 2015 **CONFIDENTIAL**



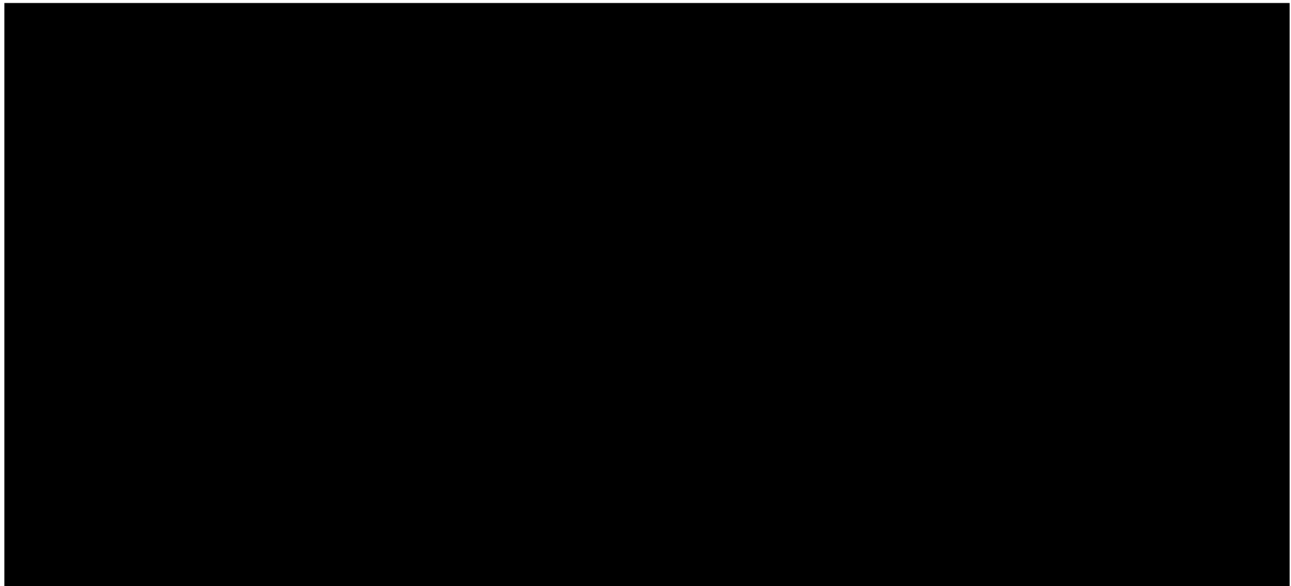
Pipeline Safety Enhancement Program Workpaper Supporting Chapter III
LINE 45-120X01 REPLACEMENT PROJECT

Pipeline Safety Enhancement Program Workpaper Supporting Chapter III
LINE 45-120X01 REPLACEMENT PROJECT

PSEP Filing Mileage (Feet)			
Total Mileage	Criteria Mileage	Accelerated Mileage	Incidental Mileage
41 feet	9 feet	32 feet	0 feet

CONFIDENTIAL

Filed

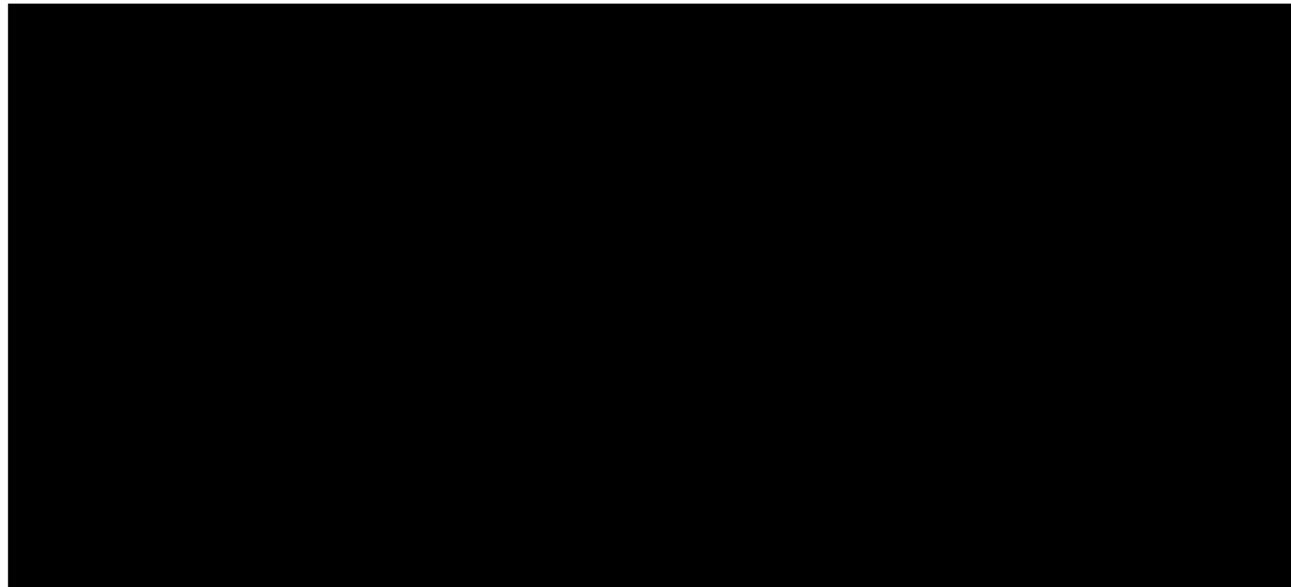


Pipeline Safety Enhancement Program Workpaper Supporting Chapter III
LINE 45-120XO1 REPLACEMENT PROJECT

Stage 1-2 Mileage (Feet)			
Total Mileage	Criteria Mileage	Accelerated Mileage	Incidental Mileage
41 feet	9 feet	27 feet	5 feet

CONFIDENTIAL

Stage 1/2



Pipeline Safety Enhancement Program Workpaper Supporting Chapter III
LINE 45-120X01 REPLACEMENT PROJECT

Stage 3-4 Mileage (Feet)			
Total Mileage	Criteria Mileage	Accelerated Mileage	Incidental Mileage
51 feet	38 feet	6 feet	7 feet

CONFIDENTIAL

Stage 3/4



Pipeline Safety Enhancement Program Workpaper Supporting Chapter III
LINE 45-120XO1 REPLACEMENT PROJECT

Stage 5 Mileage (Feet)			
Total Mileage	Criteria Mileage	Accelerated Mileage	Incidental Mileage
57 feet	38 feet	12 feet	7 feet

CONFIDENTIAL

Stage 5

End of SL-45-120XO1 Replacement Project Workpaper

Pipeline Safety Enhancement Plan Workpaper Supporting Chapter III
LINE 49-14 REPLACEMENT PROJECT

Summary

Table 1: L-49-14 Replacement Project Summary

Project Name	L-49-14 Replacement Project
WOA Number / WOA Date	1545218 / February 27, 2014
City	San Diego
Original Pipe Diameter / New Pipe Diameter	██████████
Construction Start / Construction Finish	September 22, 2014 / December 19, 2014
Loaded Capital Costs	\$ 4,702,224
Loaded O&M Costs	\$ 0
Total Loaded Project Costs	\$ 4,702,224
Disallowance	\$ 31,280

Description

Through the L-49-14 Project, SoCalGas and SDG&E enhanced its high pressure pipeline system by replacing 156 feet of pipeline with a new route that was 167 feet in length, as shown in Figures 1 and 2 and Table 2 which describes the project scope as submitted in the 2011 PSEP filing and the final construction as-built mileage.

Example of cost avoidance actions included:

- Through scope validation efforts, SoCalGas and SDG&E reduced scope mileage by over 2 miles.

Construction began in September 2014 and was completed in December 2014. The L-49-14 Project incurred a total loaded project cost of \$4,702,224.

Pipeline Safety Enhancement Plan Workpaper Supporting Chapter III
LINE 49-14 REPLACEMENT PROJECT

Table 2: L-49-14 Replacement Project 2011 PSEP Filing and Final Mileage*

Line 49-14	Total Mileage	Criteria Mileage	Accelerated Mileage**	Incidental Mileage
2011 PSEP Filing	2.450 mi.	0.316 mi.	2.134 mi	0
Total	167 ft.	97 ft.	54 ft.	16 ft.

*Values may not add to total due to rounding.

**Accelerated mileage includes Phase 1B and Phase 2 pipe. Phase 2 includes pipelines without sufficient record of a pressure test in less populated areas (Phase 2A) or pipelines with record of a pressure test, but without record of a pressure test to modern – Subpart J – standards (Phase 2B). Included in this project was 54 feet of pipe accelerated from Phase 2B. The accelerated mileage was included to realize efficiencies and to enhance project constructability

Pipeline Safety Enhancement Plan Workpaper Supporting Chapter III
LINE 49-14 REPLACEMENT PROJECT

Figure 1: Overview Map of L-49-14 Replacement Project



Figure 2: Satellite Image of L-49-14 Replacement Project



Pipeline Safety Enhancement Plan Workpaper Supporting Chapter III
LINE 49-14 REPLACEMENT PROJECT

Stage 1 – Project Initiation

In workpapers supporting the 2011 PSEP filing,¹ SoCalGas and SDG&E identified the L-49-14 project as a 2.450-mile Phase 1A replacement project.

At the time of the 2011 PSEP filing, the proposed scope was 2.450 total miles, 0.316 miles of which was Category 4 and 2.134 miles of which was accelerated pipeline. The pipeline is in the cities of National City and San Diego.

During Stage 1, scope validation was performed on L-49-14. The Stage 1 scope validation indicated:

- L-49-14 was first installed in 1952. Sections were modified in 1959, 1962, and 1975.
- Scope validation verified that a 0.298-mile section should be reclassified from Category 4 Criteria mileage to Category 1.
- At the end of Stage 1, the 2.450-mile total length of the pipeline remained in scope for replacement.

¹ See December 2, 2011 Amended Pipeline Safety Enhancement Plan (PSEP) of SoCalGas and SDG&E.

Pipeline Safety Enhancement Plan Workpaper Supporting Chapter III
LINE 49-14 REPLACEMENT PROJECT

Stage 2 – Analysis and Findings

During Stage 2, data analysis was performed and the findings were used to define project scope and to plan tasks for later stages of the project.

Through scope validation SoCalGas and SDG&E determined that 2.134 miles of accelerated mileage was de-scoped, and the associated incidental miles were reduced from 0.298 miles to 0. 97 feet of Category 4 Criteria mileage remained at the intersection of south 40th St. and Cottonwood St.

Engineering Factors

A PSEP Decision Tree analysis of L-49-14 confirmed that the project design should commence as a replacement project because L-49-14 scope was less than 1,000 feet. The PSEP Decision Tree directs that scope less than 1,000 feet should be replaced because under most circumstances it is the cost effective option. In this instance there were no conditions that justified overriding this guidance.

Pipeline Safety Enhancement Plan Workpaper Supporting Chapter III
LINE 49-14 REPLACEMENT PROJECT

Stage 3 – Initial Planning and Design

During Stage 3, SoCalGas and SDG&E developed a Phase 2 WOA estimate, and began field surveys to complete preliminary design drawings and further refine scope.

In addition to the schedule and estimate, other key activities include identifying all permits, TRE's, and easements, defining long lead materials and pricing, understanding customer impacts and interruptions, and preparing any necessary environmental submittals.

Planning and Design Activity

The initial design for L-49-14 was planned as follows:

- Create a bypass using pressure control fittings to keep the pipeline in service for two high-pressure core customers ([REDACTED]).
- Design for the use of jack-and-bore construction to install a new [REDACTED] pipeline underneath a culvert.

Additional Considerations

- Replacement of 97 feet of [REDACTED] pipe plus approximately 60 feet of pipe to reach a location out of the intersection where the tie-ins could be performed. The planned new route was deeper and had more bends than the old route to avoid the existing pipeline. Additionally, some pipe closer to grade level would need to be removed to accommodate the boring operation.
- One mobilization and demobilization
- Day work at Cottonwood St. and South 40th St. in San Diego
- Required jack-and-bore construction to facilitate pipe installation beneath an existing culvert owned and maintained by the US Army Corps of Engineers.
- Required use of two separate [REDACTED] bypasses around each tie-in piece; one 48 feet in length and one 56 feet in length, each consisting of two [REDACTED] stopples.

Pipeline Safety Enhancement Plan Workpaper Supporting Chapter III
LINE 49-14 REPLACEMENT PROJECT

Estimate of Costs

The estimated total loaded cost for L-49-14 was \$3,370,073, as shown in Table 3, on the basis of preliminary designs. This estimate was prepared on February 2, 2014, using the Stage 3 San Diego Pipeline Estimate Template Rev 0 tool.

Table 3: L-49-14 Phase 2 WOA Estimate

Cost Category	Phase 2 WOA Estimate
Company Labor Costs	\$ 267,101
Contract Costs	\$ 20,900
Material Costs	\$ 28,486
Other Direct Costs	\$ 2,554,294
Total Direct Costs	\$ 2,870,781
Total Indirect Costs	\$ 499,292
Total Loaded Costs	\$ 3,370,073

Pipeline Safety Enhancement Plan Workpaper Supporting Chapter III
LINE 49-14 REPLACEMENT PROJECT

Stage 4 – Detailed Engineering Design and Procurement

During Stage 4, detailed design and material procurement was completed in order to provide a construction ready packet to the construction contractor to execute the planned project scope.

The following actions were taken to prepare for project construction:

- Identified exact tie-in points and developed a tie-in procedure.
- Submitted notification and obtained acknowledgement from the US Army Corps of Engineers that construction impact on a culvert would not pose a risk.
- Acquired a laydown yard for construction.
- Coordinated with SDG&E Electrical Distribution for required temporary shutdown of facilities within the project area.

Detailed Planning and Design

The initial design for L-49-14 was enhanced by completing the following:

- Gathered geotechnical samples of the soils existing at the bore depth to create a geotechnical report for the purposes of confirming the feasibility of using jack-and-bore construction.
- Finalized survey and pothole data to confirm that existing subsurface utilities would not conflict with the proposed design.
- Designed the bore pits to use engineered shoring to avoid a full road closure which the final design would otherwise require.
- Due to boring operation and new route, an additional 11 feet of pipe was added to the scope, for a new scope total of 167 feet of pipe.

Pipeline Safety Enhancement Plan Workpaper Supporting Chapter III
LINE 49-14 REPLACEMENT PROJECT

Construction Contractor Selection

Construction of the L-49-14 Project utilized the PSEP Performance Partnership Program. Of the two Performance Partners selected for this geographic area, the one able to accommodate the necessary schedule was used.

The Performance Partner/Construction Contractor TPE was \$ [REDACTED], which is \$ [REDACTED] more than the Stage 3 construction contractor direct estimate of \$ [REDACTED] that was used to develop the Phase 2 WOA estimate.

Pipeline Safety Enhancement Plan Workpaper Supporting Chapter III
LINE 49-14 REPLACEMENT PROJECT

Stage 5 – Construction

Schedule

Construction Start Date: 09/22/2014

NOP Date: 11/01/2014

Construction Finish Date: 12/19/2014

Field Conditions

Conditions were encountered in the field that were not anticipated during design and planning that had to be addressed or mitigated. These conditions impacted the project scope and schedule.

Site Restoration:

- A 30-day waiting period between base pave and final pave was required by the city, which was not included in the original schedule. This period was mandated by the city to allow for settlement and compaction. Excluding this change, the construction would have finished on time.

Pipeline Safety Enhancement Plan Workpaper Supporting Chapter III
LINE 49-14 REPLACEMENT PROJECT

Stages 6 and 7 – Commissioning and Closeout

Commissioning activities included site restoration, final inspections, and placement of the pipeline back into service, transportation and disposal of the hydrotested water or hazardous material and demobilization from the site. Close out activities included development of final drawings, the reconciliation package and updates to company systems to reflect the changes made to the system.

Cost Variance

Table 4: L-49-14 Phase 2 WOA Estimate and Actual Costs

COST SUMMARY				
	PHASE 2 WOA	CAPITAL (actuals)	DELTA over/(under)	
COMPANY LABOR	\$ 267,101	\$ 175,771	\$ (91,330)	
CONTRACT COSTS	\$ 20,900	\$ 2,106,886	\$ 2,085,986	
MATERIALS	\$ 28,486	\$ 178,414	\$ 149,928	
OTHER DIRECTS	\$ 2,554,294	\$ 1,610,493	\$ (943,801)	
INDIRECTS	\$ 499,292	\$ 630,659	\$ 131,367	
TOTAL LOADED	\$ 3,370,073	\$ 4,702,224	\$ 1,332,151	

Table 4 compares the Phase 2 WOA estimate and the March 2016 total loaded actual costs. The total loaded actual costs exceeded the Phase 2 WOA estimate by \$1,332,151. The WOA estimate was calculated in Stage 3 using the Stage 3 San Diego Pipeline Estimate Template Rev 0 tool.

The above variance is mainly attributable to scope changes and unanticipated conditions that occurred after the Phase 2 WOA estimate (including: increased scope due to boring and to better enable tie-in procedures and site restoration requirements) and an early cost estimating tool and process that was based on preliminary project designs (resulting in underestimating of materials, construction, inspection, project support, and close-out costs). These increased costs were reasonably incurred to complete the pipeline replacement, but were not accounted for in the Stage 3 estimate.

Pipeline Safety Enhancement Plan Workpaper Supporting Chapter III
LINE 49-14 REPLACEMENT PROJECT

Disallowances

For this replacement project, SoCalGas and SDG&E has identified pipe as being installed post 1955 and lacking records that provide the minimum information to demonstrate compliance with industry standards or regulatory strength testing and recordkeeping requirements then applicable. Of the pipeline that was replaced, 97 feet of Phase 1A pipe are disallowed. Therefore a \$31,280 reduction was made to ratebase calculated by determining the replacement mileage and multiplying the amount by \$1.7 million per mile, which is SoCalGas' and SDG&E's system average cost of pressure testing.

Pipeline Safety Enhancement Plan Workpaper Supporting Chapter III
LINE 49-14 REPLACEMENT PROJECT

Conclusion

SoCalGas and SDG&E enhanced the safety of their natural gas system by prudently executing the L-49-14 Replacement Project. Through this replacement project, SoCalGas and SDG&E successfully replaced 156 feet of existing pipe and added 11 feet of new pipe to account for a re-route in the City of San Diego. The project incurred a total loaded project cost of \$4,702,224.

SoCalGas and SDG&E executed this project prudently: minimizing community and customer impacts; maintaining service to high pressure core customers through the installation of a double bypass; safely designing and executing the project by boring underneath a culvert; and designing and installing the new pipeline to avoid subsurface facilities.

SoCalGas and SDG&E's total loaded project cost of \$4,702,224 is reasonable and should be approved (minus acknowledged disallowances). SoCalGas and SDG&E engaged in prudent cost avoidance efforts (reducing project scope by over 2 miles); engaged in reasonable efforts to promote competitive and market-based rates for contractor services and materials (see Chapter II (Phillips) (approximately 98% of PSEP agreements with contractors and suppliers were either competitively bid or through agreements entered into using market-based rates based on a recent competitive sourcing event)); and used a reasonable amount of company and contractor resources given the complex scope of work (creating a bypass to maintain service to core customers, using jack and bore construction to install the pipeline underneath a culvert, and designing the project to avoid existing subsurface facilities) and work scope changes (permit delays and site restoration requirements).

End of Line 49-14 Replacement Project Workpaper

Pipeline Safety Enhancement Program Workpaper Supporting Chapter III
LINE 49-22 ABANDONMENT PROJECT

Summary

Table 1: Summary of L-49-22 (Sections 1 & 2) Abandonment Project – Sections 1 & 2

Project Name	L-49-22 (Sections 1 & 2) Abandonment Project
WOA Number / Date	1545240 / August 27, 2014
City	National City / Chula Vista
Original Pipe Diameter/New Diameter	Abandonment
Construction Start / Finish Section 1	April 21, 2014 / June 20, 2014
Construction Start / Finish Section 2	October 13, 2014 / January 23, 2015
Loaded Capital Costs	\$ 5,034,329
Loaded O&M Costs	\$ 0
Total Loaded Project Costs	\$ 5,034,329
Disallowance	\$ 0

Description

Through the L-49-22 (Sections 1 & 2) Abandonment Project, SoCalGas and SDG&E abandoned 4.05 miles of 1950 pipeline, as shown in Figures 1 through 6 and Table 2 that describe the project scope as submitted in the 2011 PSEP filing and the final construction as-built mileage.

An example of cost avoidance actions included:

- The schedule for the National City portion of the project was advanced in order to execute around a city repaving project. If the construction was executed after the city’s repaving project, SDG&E would have had to pay for a “curb to curb” resurfacing.

Construction began in April 2014 and was completed in January 2015. The L-49-22 Project incurred a total loaded project cost of \$5,034,329.

Pipeline Safety Enhancement Program Workpaper Supporting Chapter III
LINE 49-22 ABANDONMENT PROJECT

Table 2: L-49-22 - 2011 PSEP Filing and Final Mileage*

	Total Mileage	Criteria Mileage	Accelerated Mileage**	Incidental Mileage
2011 PSEP Filing	4.037 mi	3.913 mi	0.124 mi	0
Final Project Mileage				
Section 1	1.994 mi	1.883 mi	0	586 ft
Section 2	2.052 m	2.036 mi	2 ft	84 ft
Total	4.046 mi	3.919 mi	2 ft	670 ft

**Values may not add to total due to rounding.*

***Accelerated mileage includes Phase 1B and Phase 2 pipe. Phase 2 includes pipelines without sufficient record of a pressure test in less populated areas (Phase 2A) or pipelines with record of a pressure test, but without record of a pressure test to modern – Subpart J – standards (Phase 2B). Included in this project was 2 feet of pipe accelerated from Phase 2B. The accelerated mileage was included to realize efficiencies and to enhance project constructability.*

Pipeline Safety Enhancement Program Workpaper Supporting Chapter III
LINE 49-22 ABANDONMENT PROJECT

Figure 1: Overview Map of L-49-22 Abandonment Project



Figure 2: Satellite Image of L-49-22 Abandonment Project



Pipeline Safety Enhancement Program Workpaper Supporting Chapter III
LINE 49-22 ABANDONMENT PROJECT

Figure 3: Overview map of L-49-22 Section 1 Abandonment Project



Figure 4: Satellite Image of L-49-22 Section 1 Abandonment Project



Pipeline Safety Enhancement Program Workpaper Supporting Chapter III
LINE 49-22 ABANDONMENT PROJECT

Figure 5: Overview map of L-49-22 Section 2 Abandonment Project



Figure 6: Satellite Image of L-49-22 Section 2 Abandonment Project



Pipeline Safety Enhancement Program Workpaper Supporting Chapter III
LINE 49-22 ABANDONMENT PROJECT

Stages 1 and 2 – Project Initiation, Analysis and Findings

In workpapers supporting the 2011 PSEP filing,¹ SoCalGas and SDG&E identified the L-49-22 Project as a 4.037-mile Phase 1A abandonment project. The pipeline runs through the cities of National City and Chula Vista.

The decision to abandon L-49-22 was made because there was sufficient redundancy provided by L-49-23, which is a [REDACTED] line that runs parallel to L-49-22. By abandoning L-49-22 SoCalGas and SDG&E avoided the expense to test or replace this 4-mile pipeline.

During Stage 1, scope validation confirmed that portions of L-49-22 should be reclassified from Phase 1A to incidental.

Because this project was an abandonment, a test versus replace analysis was unnecessary and Stages 1 and 2 activities were blended.

¹ See December 2, 2011 Amended Pipeline Safety Enhancement Plan (PSEP).

Pipeline Safety Enhancement Program Workpaper Supporting Chapter III
LINE 49-22 ABANDONMENT PROJECT

Stage 3 – Initial Planning and Design

During Stage 3, SoCalGas and SDG&E developed a Phase 2 WOA estimate, and began field surveys to complete preliminary design drawings and further refine scope.

In addition to the schedule and estimate, other key activities include identifying all permits, TRE's, and easements, defining long lead materials and pricing, understanding customer impacts and interruptions, and preparing any necessary environmental submittals.

Planning and Design Activity

- Abandon 4.04 miles of predominantly [REDACTED] pipe.
- Abandonment activities would start in National City (Section 1) then proceed to Chula Vista (Section 2). Before the abandonment work for National City was completed a permit would be issued by the city of Chula Vista for Section 2 work so there was only one planned mobilization and demobilization.
- 12 separate sites for reconfiguration to allow abandonment.
- Two separate municipal permits.

Additional Considerations

As part of project development, both cities were approached and informed of the project to discuss any concerns or opportunities for coordination. PSEP was informed that National City was planning an extensive street repaving project in the same vicinity as the PSEP project. They advised of a pending construction moratorium in the area and requested that L-49-22 be completed before the moratorium and the street repaving. To that end, the city supported the expedited processing of SDG&E's permit applications. Meanwhile, the City of Chula Vista indicated that they would follow their normal review and approval process.

Pipeline Safety Enhancement Program Workpaper Supporting Chapter III
LINE 49-22 ABANDONMENT PROJECT

In order to meet the unique planning requirements of each city, SoCalGas and SDG&E had to operate under two distinct timelines. This required splitting the project into two sections distinguished by the two cities: National City (Section 1) and Chula Vista (Section 2). Section 1 was installed in 1950 and contains five branch connections to laterals that were to be reconfigured. Section 2 was installed in 1949 and 1950 and contains seven branch connections that were to be reconfigured.

Cost Avoidance

The schedule for the National City portion of the project was planned for advancement in order to execute around a city repaving project. If the construction was executed after the city’s repaving project, SDG&E would have had to pay for a “curb to curb” resurfacing.

Estimate of Costs

The estimated total loaded cost for the abandonment of 4.04 miles was \$2,646,988, as shown in Table 3, and is based on preliminary design. This estimate was prepared in February 2014 using the Stage 3 San Diego Pipeline Estimate Template Rev 0 tool.

Table 3: L-49-22 Phase 2 WOA Estimate

Cost Category	Phase 2 WOA
Company Labor Costs	\$ 332,684
Contract Costs	\$ 0
Material Costs	\$ 170,572
Other Direct Costs	\$ 1,389,038
Total Direct Costs	\$ 1,892,474 294
Total Indirect Costs	\$ 754,514
Total Loaded Costs	\$ 2,646,988

Pipeline Safety Enhancement Program Workpaper Supporting Chapter III
LINE 49-22 ABANDONMENT PROJECT

Stage 4 – Detailed Engineering Design and Procurement

During Stage 4, detailed design and material procurement was completed in order to provide a construction ready packet to the construction contractor to execute the planned project scope. SoCalGas and SDG&E performed the following actions to prepare for project construction:

Detailed Planning and Design

- Scope was detailed in the RER and the Site-by-Site Plan.
- A construction permit would be obtained from the National City.
- Design Drawings progressed to an Issued for Construction Package for both sections.
- Detailed designs were developed for the 12 separate sites. Each site addressed an instance where L-49-22 was connected to other pipelines. These included cross over piping tying together 49-22 and 49-23 (49-23 runs parallel to 49-22); and piping from 49-22 feeding laterals; and connections of 49-22 to 49-16 at the north end and 49-24 at the south end. Each connection requiring remediation was unique and needed its own planning and design.
- A plan for addressing each site individually was developed which required eight new pressure control fittings to facilitate isolation.
- A laydown yard at Broadway and Park Way was leased.
- Materials for both sections were ordered through PSEP Supply Management.
- Project design would be split because of the need to complete work prior to a repaving project by National City.
- Acquisition of permit from Chula Vista took longer than normal with a number of design changes and as a result drawings changed.

Pipeline Safety Enhancement Program Workpaper Supporting Chapter III
LINE 49-22 ABANDONMENT PROJECT

Construction Contractor Selection

Construction was performed by SDG&E Field Operations.

Pipeline Safety Enhancement Program Workpaper Supporting Chapter III
LINE 49-22 ABANDONMENT PROJECT

Stage 5 – Construction

Schedule

Section 1: National City

Construction Start Date: 04/21/2014
NOP Date: 12/16/2014
Construction Finish Date: 06/20/2014

Section 2: Chula Vista

Construction Start Date: 10/13/2014
NOP Date: 12/16/2014
Construction Finish Date: 01/23/2015

Field Conditions

Conditions were encountered in the field that were not anticipated during design and planning that had to be addressed or mitigated. The following conditions impacted the project scope and schedule:

Permit Conditions:

- The City of Chula Vista required over three months from first drawing submittal to issue a permit (Note: the City of National City permit was obtained in Stage 4).

Pipeline Safety Enhancement Program Workpaper Supporting Chapter III
LINE 49-22 ABANDONMENT PROJECT

Field Conditions:

- An existing pressure control fitting installed on the pipeline that was planned to be used for isolation was a nonstandard design. A new pressure control fitting was installed nearby in a new excavation.
- At a different location, construction crews planned to use an existing pressure control fitting for isolation. Upon excavation an unknown tap off the line was discovered which prevented the use of the existing pressure control fitting for isolation. A new pressure control fitting was installed downstream of the tap to facilitate isolation of 49-22.

Site Restoration:

- The City of Chula Vista was initially dissatisfied with the site restoration efforts. Additional work was performed under the guidance of the Contract Administrator to replace a tree and other landscaping.

Pipeline Safety Enhancement Program Workpaper Supporting Chapter III
LINE 49-22 ABANDONMENT PROJECT

Stages 6 and 7 – Commissioning and Closeout

Commissioning activities included site restoration, final inspections, and demobilization from the site. Close out activities included development of final drawings, the reconciliation package and updates to company systems to reflect the changes made to the system.

Cost Variance

Table 4: L-49-22 (Sections 1 & 2) Phase 2 WOA Estimate and Actual Costs

COST SUMMARY				
	PHASE 2 WOA	CAPITAL (actuals)	DELTA over/(under)	
COMPANY LABOR	\$ 332,864	\$ 565,243	\$	232,379
CONTRACT COSTS	\$ -	\$ 1,233,005	\$	1,233,005
MATERIALS	\$ 170,572	\$ 138,986	\$	(31,586)
OTHER DIRECTS	\$ 1,389,038	\$ 2,078,945	\$	689,907
INDIRECTS	\$ 754,514	\$ 1,018,149	\$	263,635
TOTAL LOADED	\$ 2,646,988	\$ 5,034,329	\$	2,387,341

Table 4 compares the Phase 2 WOA estimate and the March 2016 loaded actual costs. The loaded actual costs exceeded the Phase 2 WOA estimate by \$2,387,341. The WOA estimate was calculated in Stage 3 using the Stage 3 San Diego Pipeline Estimate Template Rev. 0.

The above variance is attributable to scope changes and unanticipated conditions that occurred after the Phase 2 WOA estimate (including: permit delays, unknown conditions discovered after excavation, and site restoration requirements) and the cost estimating tool and process (specifically, that the cost estimating tool was not designed for abandonment projects resulting in underestimating of system and documentation changes necessitated by the abandonment, construction work, ROW acquisition, project support services, and close-out documentation). These increased costs were reasonably incurred to complete the pipeline abandonment, but were not accounted for in the Stage 3 estimate.

Pipeline Safety Enhancement Program Workpaper Supporting Chapter III
LINE 49-22 ABANDONMENT PROJECT

Disallowances

There was no disallowance for line L-49-22 Abandonment Project as there were no post-1955 segments included in the project without records that provide the minimum information to demonstrate compliance with industry standards or regulatory strength testing and recordkeeping requirements then applicable.

Pipeline Safety Enhancement Program Workpaper Supporting Chapter III
LINE 49-22 ABANDONMENT PROJECT

Conclusion

SoCalGas and SDG&E successfully and prudently executed the L-49-22 (sections 1 & 2) Abandonment Project. Through this abandonment project, SoCalGas and SDG&E successfully abandoned 4.04 miles of pipe in the Cities of National City and Chula Vista. The project incurred a total loaded project cost of \$5,034,329.

SoCalGas and SDG&E executed this project prudently: minimizing customer and community impacts; advancing the work schedule to execute around a city repaving project; and choosing to abandon L-49-22 based on analysis of system redundancy.

SoCalGas and SDG&E's total loaded project cost of \$5,034,329 is reasonable and should be approved. SoCalGas and SDG&E engaged in prudent cost avoidance efforts (advancing the work schedule to execute around a city repaving project); engaged in reasonable efforts to promote competitive and market-based rates for contractor services and materials (see Chapter II (Phillips) (approximately 98% of PSEP agreements with contractors and suppliers were either competitively bid or through agreements entered into using market-based rates based on a recent competitive sourcing event)); and used a reasonable amount of company and contractor resources given the complex scope of work (work in a city street on an expeditious time line) and work scope changes (permit delays, adapting to unknowns discovered after excavation, and site restoration requirements).

End of Line 49-22 Abandonment Project Workpaper

Pipeline Safety Enhancement Plan Workpaper Supporting Chapter III
LINE 49-32 REPLACEMENT PROJECT

Summary

Table 1: L-49-32 Replacement Project Summary

Project Name	L-49-32 Replacement Project
WOA Number / Date	1545238 / November 21, 2013
City	San Diego
Original Pipe Diameter/New Diameter	██████████
Construction Start / Finish	June 23, 2014 / October 31, 2014
Loaded Capital Costs	\$4,393,207
Loaded O&M Costs	\$ 0
Total Loaded Project Costs	\$4,393,207
Disallowance	\$ 0

Description

Through the L-49-32 Replacement Project, SoCalGas and SDGE enhanced its high pressure pipeline system by replacing 332 feet of non-contiguous pipeline, as shown in Figures 1 through 6 and Table 2 which describes the project scope as submitted in the 2011 PSEP filing and the final mileage.

Examples of cost avoidance actions included:

- Through scope validation efforts, scope was reduced by over 1,000 feet.
- Installation of a small diameter temporary bypass kept nine core customers on-line without the use of CNG/LNG.
- By removing the valve at the boundary of L-49-32 and L-49-11 and the associated piping from service, the new route was shortened and 322 feet of pipe was replaced with a shorter 262-foot segment (Section 1).

Construction began in June 2014 and was completed in October 2014. The L-49-32 Replacement Project incurred a total loaded project cost of \$4,393,207.

Pipeline Safety Enhancement Plan Workpaper Supporting Chapter III
LINE 49-32 REPLACEMENT PROJECT

Table 2: L-49-32 2011 Replacement Project 2011 PSEP Filing and Final Mileage*

	Total Mileage	Criteria Mileage	Accelerated Mileage***	Incidental Mileage**
2011 PSEP Filing	0.255 mi.	0.255 mi.	0.000	0.000
As Built:				
Section 1	322 ft.	262 ft.	17 ft	44 ft.
Section 2	10 ft.	9 ft.	0	1 ft.
Final Project Mileage	332 ft.	271 ft.	17	44 ft.

*Values may not add to total due to rounding

**Incidental footage includes 49-11 segment.

***Accelerated mileage includes Phase 1B and Phase 2 pipe. Phase 2 includes pipelines without sufficient record of a pressure test in less populated areas (Phase 2A) or pipelines with record of a pressure test, but without record of a pressure test to modern – Subpart J – standards (Phase 2B). Included in this project was 17 feet of pipe accelerated from Phase 2B. The accelerated mileage was included to realize efficiencies and to enhance project constructability.

Pipeline Safety Enhancement Plan Workpaper Supporting Chapter III
LINE 49-32 REPLACEMENT PROJECT

Figure 1: Overview Map of L-49-32 Replacement Project

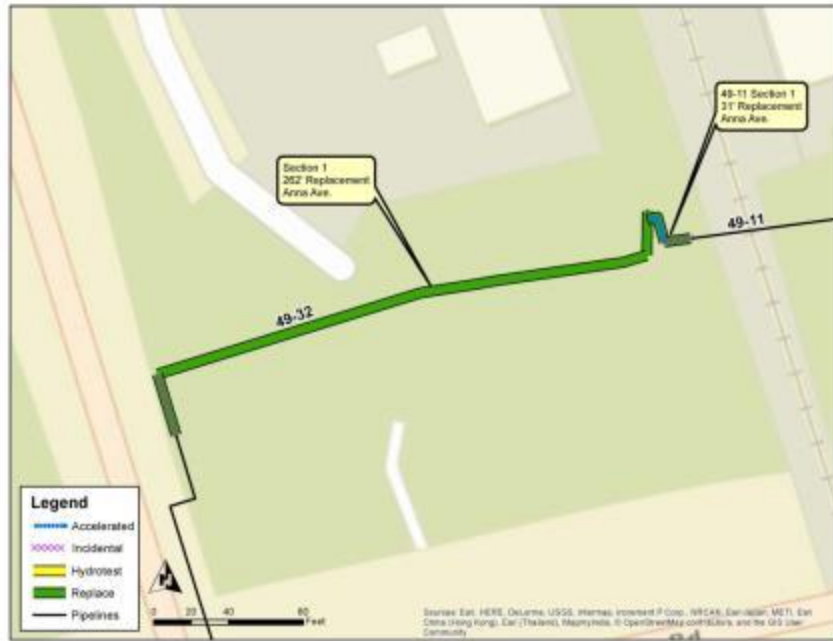


Figure 2: Satellite Image of L-49-32 Replacement Project



Pipeline Safety Enhancement Plan Workpaper Supporting Chapter III
LINE 49-32 REPLACEMENT PROJECT

Figure 3: Overview Map of L-49-32 Section 1 Replacement Project



Pipeline Safety Enhancement Plan Workpaper Supporting Chapter III
LINE 49-32 REPLACEMENT PROJECT

Figure 4: Satellite Image of L-49-32 Section 1 Replacement Project



Pipeline Safety Enhancement Plan Workpaper Supporting Chapter III
LINE 49-32 REPLACEMENT PROJECT

Stage 1 – Project Initiation

In workpapers supporting the 2011 PSEP filing,¹ SoCalGas and SDG&E identified the L-49-32 project as a 0.255 mile Phase 1A replacement project. The entire length was a Category 4, Class 3 location pipeline located within the City of San Diego.

During Stage 1, scope validation confirmed that L-49-32 was first installed in 1933 with modifications made in 1950 and 1952. As a result of scope validation efforts, 1,074 feet of Category 4 Criteria pipe was confirmed to be Category 2 Criteria pipe and thus reduced the scope to a total of 272 feet in two sections.

¹ See December 2, 2011 Amended Pipeline Safety Enhancement Plan (PSEP).

Pipeline Safety Enhancement Plan Workpaper Supporting Chapter III
LINE 49-32 REPLACEMENT PROJECT

Stage 2 – Analysis and Findings

During Stage 2, data analysis was performed and the findings were used to define project scope and to plan tasks for later stages of the project. SoCalGas and SDG&E concluded that the project scope remained unchanged from Stage 1.

Engineering Factors

The PSEP Decision Tree analysis of L-49-32 indicated that the project design should commence as a replacement project. The PSEP Decision Tree directs that scope less than 1,000 feet should be replaced because, under most circumstances, it is the cost effective option. In this instance, there were no conditions that justified overriding this conclusion.

Pipeline Safety Enhancement Plan Workpaper Supporting Chapter III
LINE 49-32 REPLACEMENT PROJECT

Stage 3 – Initial Planning and Design

During Stage 3, SoCalGas and SDG&E developed a Phase 2 WOA estimate, and began field surveys to complete preliminary design drawings and further refine scope.

In addition to the schedule and estimate, other key activities include identifying all permits, TRE's, and easements, defining long lead materials and pricing, understanding customer impacts and interruptions, and preparing any necessary environmental submittals.

Planning and Design Activity

The initial planning and design for L-49-32 was planned to occur as follows:

Section 1

- Install approximately 262 feet of predominantly [REDACTED] pipe. This would be accomplished by removing existing pipe and installing new pipe in a new, shorter route.
- Create a [REDACTED] 66-foot bypass to continue to serve Regulator Station 981.
 - This bypass would allow the line to remain in service and avoid impact to 9 core customers and avoid the expense of CNG/LNG support.
- In order to facilitate pigging in both directions, the boundary of [REDACTED] and [REDACTED] pipe would be moved approximately 160 feet west.
- Utilize SDG&E Field Operations to perform construction.
- Create a work plan to accompany the joint right of entry permit application for the temporary construction work in the jurisdiction of the Metropolitan Transit System and the North County Transit District.
- Coordinate with the United States Navy to avoid future relocation of SDG&E pipe because of an [REDACTED] aviation fuel pipeline that crossed the intended route of L-49-32.

Pipeline Safety Enhancement Plan Workpaper Supporting Chapter III
LINE 49-32 REPLACEMENT PROJECT

- The fuel line is owned, operated, and maintained by the Navy who also identified an additional future project in the area.

Section 2

- Install 10 feet of [REDACTED] pipe. This would be accomplished by removing 10 feet of pipe and replacing it along the same route.

Additional Considerations

- Considered modifying construction schedule to avoid bird nesting season.

Estimate of Costs

The estimated total loaded cost for the L-49-32 Replacement Project was \$5,209,173, as shown in Table 3, on the basis of preliminary designs. This estimate was prepared on February 2, 2014, using the Stage 3 San Diego Pipeline Estimate Template Rev 0 tool.

Table 3: L-49-32 Phase 2 WOA Estimate

Cost Category	Phase 2 WOA
Company Labor Costs	\$240,534
Contract Costs	\$11,550
Material Costs	\$163,303
Other Direct Costs	\$1,794,799
Total Direct Costs	\$2,210,186
Total Indirect Costs	\$2,998,897
Total Loaded Costs	\$5,209,173

Pipeline Safety Enhancement Plan Workpaper Supporting Chapter III
LINE 49-32 REPLACEMENT PROJECT

Stage 4 – Detailed Engineering Design and Procurement

During Stage 4, detailed design and material procurement was completed in order to provide a construction ready packet to the construction contractor to execute the planned project scope.

Detailed Planning and Design

- Confirmed exact tie-in points and calculated incidental mileage.
 - Identified there was a valve at the boundary of L-49-32 and L-49-11 that could be removed from service (plan at this time was to abandon in place). By bypassing the valve and the associated piping, the new route would be shorter. Therefore, 332 feet of pipe could be remediated by installing 272 feet of pipe (both sections).
- Designed a 66-foot temporary bypass to provide temporary service to core customers.
- Revised the work plan at the request of Metropolitan Transit System and the North County Transit District in order to obtain permitting.
- Increased coordination with the San Diego Association of Governments as part of the ongoing coordination with Metropolitan Transit System and the North County Transit District due to the transit authorities' plans to substantially change the grade in the area and build another railroad track.
- Coordinated with a landowner, who had in-process construction plans with the city to increase the elevation of the property to fix a drainage issue and allow for other improvements.
- Adjusted the slope of the pipeline to go under, rather than over the Navy's [REDACTED] aviation fuel line and [REDACTED] proposed storm drain.
- Coordinated with SDG&E Electrical Distribution for required temporary shutdown of facilities within the project area.

Pipeline Safety Enhancement Plan Workpaper Supporting Chapter III
LINE 49-32 REPLACEMENT PROJECT

Additional Considerations

- One mobilization and demobilization.
- SDG&E Field Operations would perform construction.
- Traffic permit was issued for day work (Monday-Friday, 9am-3pm).
- Pipe of this vintage was assumed to be asbestos contaminated.
- The two sections were approximately 1,000 feet from each other.

Construction Contractor Selection

Construction was performed by SDG&E Field Operations.

Pipeline Safety Enhancement Plan Workpaper Supporting Chapter III
LINE 49-32 REPLACEMENT PROJECT

Stage 5 – Construction

Schedule

Construction Start Date: 06/23/2014

NOP Date: 08/25/2014

Construction Finish Date: 10/31/2014

As described below, the two-week schedule delay was caused by unforeseen conditions encountered in the field which required redesign.

Field Conditions

Section 2 progressed as planned with no issues however at Section 1 conditions were encountered in the field that were not anticipated during design and planning that had to be addressed or mitigated. These conditions impacted the project scope and schedule. Listed below is a summary of the key field changes broken down by type of change for this project:

Constructability Issues:

- Potholing reports indicated the soil conditions to be sandy; however, the impacts of sandy soil were more severe than anticipated. As a result, the following design modifications were made:
 - Originally, the entire length of pipe that was being retired from service was planned to be excavated and removed. After starting construction it became clear this would be too costly, so significant portions were abandoned in place.
 - Changes to the engineered shoring were required in order to safely execute the excavations. The shoring changes necessitated the re-routing of a ██████ conduit and removal and replacement of a guard rail at the edge of the construction footprint.

Pipeline Safety Enhancement Plan Workpaper Supporting Chapter III
LINE 49-32 REPLACEMENT PROJECT

- Power poles in the area had to be reinforced because digging near them could create instability in the pole’s foundation.
- Removal of a [REDACTED] valve, rather than abandoning it in place, was performed to accommodate a future water line planned by the City of San Diego.
- Clearance issues with the [REDACTED] casing and piping on the low-pressure side of Regulator Station 981 required a redesign.

Substructures:

- The sandy soil conditions were unsafe for excavating under the underground 230kV line and necessitated the re-route of the connection for L-49-11-I (lateral that feeds regulator station 1474) to go over it rather under it. This resulted in 5 bends rather than the original plan for just one.

Access:

- Delays in obtaining rail permits from the North County Transit District delayed project completion.

Pipeline Safety Enhancement Plan Workpaper Supporting Chapter III
LINE 49-32 REPLACEMENT PROJECT

Stages 6 and 7 – Commissioning and Closeout

Commissioning activities included site restoration, final inspections, and placement of the pipeline back into service, transportation and disposal of the hydrotested water or hazardous material and demobilization from the site. Close out activities included development of final drawings, the reconciliation package and updates to company systems to reflect the changes made to the system.

Cost Variance

Table 4: L-49-32 Phase 2 WOA Estimate and Actual Costs

COST SUMMARY				
	PHASE 2 WOA	CAPITAL (actuals)	DELTA over/(under)	
COMPANY LABOR	\$ 240,534	\$ 551,540	\$	311,006
CONTRACT COSTS	\$ 11,550	\$ 794,068	\$	782,518
MATERIALS	\$ 163,303	\$ 157,531	\$	(5,772)
OTHER DIRECTS	\$ 1,794,799	\$ 1,992,296	\$	197,497
INDIRECTS	\$ 2,998,987	\$ 897,770	\$	(2,101,217)
TOTAL LOADED	\$ 5,209,173	\$ 4,393,207	\$	(815,966)

Table 4 compares the Phase 2 WOA estimate and the March 2016 loaded actual costs. The costs were estimated using the Stage 3 San Diego Pipeline Estimate Template Rev 0 tool. The Phase 2 WOA estimate incorrectly included \$2.1 million of engineering overhead. The overhead is for non-incremental loader and is excluded from the project actual costs. Please see Johnny Huleis’s testimony for SoCalGas and SDG&E non-incremental overhead loader discussion.

The direct cost increases are mainly attributable to the scope changes that occurred after the Phase 2 WOA estimate and unanticipated conditions during construction (including: soil conditions that necessitated additional field activities and project redesign, the congested nature of the corridor that required rerouting underneath both an existing aviation fuel line and a water line, landowner improvements, agency permitting delays, land acquisition and clearance issues

Pipeline Safety Enhancement Plan Workpaper Supporting Chapter III
LINE 49-32 REPLACEMENT PROJECT

associated with the nearby regulator station pipelines and other facilities) and an early cost estimating tool and process that was based on preliminary project designs (resulting in underestimating of inspection services, project support costs, and environmental costs). These increased costs were reasonably incurred to complete this replacement work, but were not fully accounted for in the Stage 3 estimate.

Disallowances

There was no disallowance for line L-49-32 Replacement as there were no post-1955 segments included in the project without records that provide the minimum information to demonstrate compliance with industry standards or regulatory strength testing and recordkeeping requirements then applicable.

Pipeline Safety Enhancement Plan Workpaper Supporting Chapter III
LINE 49-32 REPLACEMENT PROJECT

Conclusion

SoCalGas and SDG&E enhanced the safety of their natural gas system by prudently executing the L-49-32 Replacement Project. Through this replacement project, SoCalGas and SDG&E successfully replaced 332 feet of non-contiguous pipe of varying diameter in the City of San Diego. The project incurred a total loaded project cost of \$4,393,207.

SoCalGas and SDG&E executed this project prudently: reducing project scope through scope validation; minimizing customer impact; designing the project to shorten the pipeline route and facilitate pigging; safely designing and executing the project in a congested area to avoid or account for aviation fuel lines, water lines, planned additional railroad tracks, and planned landowner improvements; and responding to poor soil conditions.

SoCalGas and SDG&E engaged in prudent cost avoidance efforts (reducing project scope, installing small bypass to keep customers online without use of CNG/LNG; designing the project to shorten the pipeline route); engaged in reasonable efforts to promote competitive and market-based rates for contractor services and materials (see Chapter II (Phillips) (approximately 98% of PSEP agreements with contractors and suppliers were either competitively bid or through agreements entered into using market-based rates based on a recent competitive sourcing event)); used a reasonable amount of company and contractor resources given the complex scope of work (install bypass to maintain service, perform work in Metropolitan Transit System and the North County Transit District), and work scope changes and two-week delay driven by soil conditions, congested workspace, and demands of landowners and permitting agencies.

End of L-49-32 Replacement Project Workpaper

Pipeline Safety Enhancement Plan Workpaper Supporting Chapter III
PLAYA DEL REY PHASE 4 & 5 HYDROTEST PROJECT

Summary

Table 1: PDR Phases 4 & 5 Hydrotest Project Summary

Project Name	PDR Phases 4 & 5 Hydrotest Project
Project Type	Hydrotest
WOA Number / WOA Date	25828 / December 17, 2014
City	Playa del Rey (City of Los Angeles)
Original Pipe Diameter (in.)	██████████
Construction Start / Construction Finish	March 11, 2015 / June 15, 2015
Loaded Capital Costs	\$ 0
Loaded O&M Costs	\$5,336,370
Total Loaded Project Costs	\$5,336,370
Disallowance	\$3,067,096(O&M)

Background

Due to the complexity of the piping configuration at the Playa del Rey (PDR) Hydrotest Storage Facility, it was divided into six separate phases. Phase 1 and 2 were filed for cost recovery and submitted in SoCalGas and SDG&E’s PSRMA (A.14-12-016), while Phases 3 and 6 are outside of the PSEP scope. This workpaper presents the project information and costs associated with Phases 4 and 5.

- Phase 4 consists of hydrotesting Category 4 “F” rated (MAOP of 1305 psig) station pipe in the “upstairs” area of the PDR storage field.
- Phase 5 consists of hydrotesting Category 4 “GR” rated (MAOP of 2000 psig) station pipe in the “upstairs” area of the PDR storage field. Constraints of the tests are depicted in Figure 1.

Pipeline Safety Enhancement Plan Workpaper Supporting Chapter III
PLAYA DEL REY PHASE 4 & 5 HYDROTEST PROJECT

Description

Through the PDR Phases 4 & 5 Hydrotest Project, SoCalGas and SDG&E enhanced its high-pressure transmission pipeline system by pressure testing 1,418 feet of injection piping, as shown in Figures 1 and 2 and Table 2 that describe the project scope as of the 2011 PSEP filing date and the final mileage.

Example of cost avoidance actions included:

- By combining Phases 4 and Phase 5, SoCalGas and SDG&E only mobilized the contractor once, thereby reducing costs related to multiple mobilizations.

Construction began in March 2015 and was completed in June 2015. The PDR Phases 4 & 5 Hydrotest Project incurred a total loaded project cost of \$5,336,370.

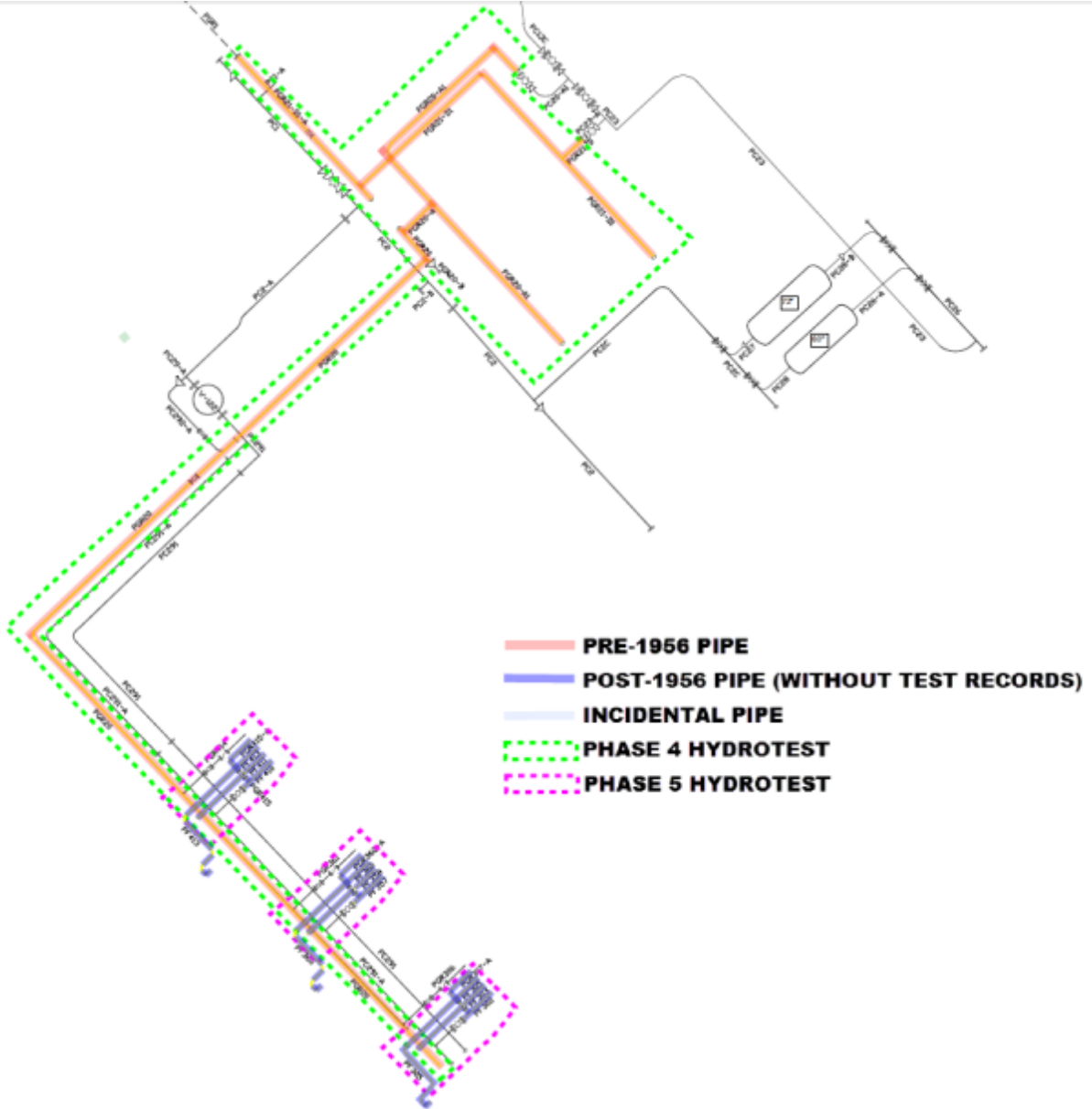
Table 2: PDR Phase 4 & 5 - 2011 PSEP Filing and Final Mileage

PDR Phase 4&5	Total Mileage	Criteria Mileage	Accelerated Mileage	Incidental Mileage
2011 PSEP Filing	1.918 mi.	1.918 mi.	0.000	0.000
Total	1418 ft.	1418 ft.	0.000	0.000

**Values may not add to total due to rounding.*

Pipeline Safety Enhancement Plan Workpaper Supporting Chapter III
PLAYA DEL REY PHASE 4 & 5 HYDROTEST PROJECT

Figure 1: Overview Map of PDR Phases 4 & 5 Hydrotest Project



Pipeline Safety Enhancement Plan Workpaper Supporting Chapter III
PLAYA DEL REY PHASE 4 & 5 HYDROTEST PROJECT

Stage 1 – Project Initiation

In workpapers supporting the 2011 PSEP filing,¹ SoCalGas and SDG&E identified the PDR Storage Facility Project as a Phase 1A hydrotest project. It comprised approximately 1.918 miles of Category 4 Criteria pipe.

During Stage 1, SoCalGas and SDG&E completed scope validation to prepare for engineering analysis and design of the PDR Phases 4 & 5 Hydrotest Project. Scope validation efforts confirmed the following:

- Portions of the pipe had been pressure tested by SoCalGas and SDG&E's Pipeline Integrity Department reducing the scope from 1.918 miles of Category 4 Criteria to 681 feet for Phases 1 and 2 and 1,418 feet for Phases 4 and 5.
- The pipe in Phases 4 and 5 was installed between 1955-1970.

¹ See December 2, 2011, Amended Pipeline Safety Enhancement Plan (PSEP) of SoCalGas and SDG&E.

Pipeline Safety Enhancement Plan Workpaper Supporting Chapter III
PLAYA DEL REY PHASE 4 & 5 HYDROTEST PROJECT

Stage 2 – Analysis and Findings

During Stage 2, data analysis was performed and the findings were used to define project scope and to plan tasks for later stages of the project.

Engineering Factors

Based on the PSEP Decision Tree, SoCalGas and SDG&E confirmed that the project design should commence as a hydrotest project because the PDR facility was able to be shut-in due to the availability of supply at the other facilities. The facility shut-in was approved by Gas Control with the design for manageable customer impact.

The engineering and design for the PDR project was split into two different sections (Phase 4 and Phase 5) based on the MAOP. Phase 4 scope for all pipes with an MAOP of 1,305 psig and Phase 5 scope for all pipes with an MAOP of 2,000 psig.

Pipeline Safety Enhancement Plan Workpaper Supporting Chapter III

PLAYA DEL REY PHASE 4 & 5 HYDROTEST PROJECT

Stage 3 – Initial Planning and Design

During Stage 3, SoCalGas and SDG&E developed a Phase 2 WOA estimate, and began field surveys to complete preliminary design drawings and further refine the scope.

In addition to the schedule and estimate, other key activities include identifying all permits, TREs, and easements, defining long lead materials and pricing, understanding customer impacts and interruptions, and preparing any necessary environmental submittals.

Planning and Design Activity

The initial engineering design for the PDR Phases 4 & 5 Hydrotest Project was planned to occur as follows:

- The storage facility would be shut in for several months to allow for fabrication, hydrotest preparation work, hydrotest, drying, and post hydrotest work.
- Phase 4 included piping from three independent compressor assemblies to three independent cooling systems, respectively, for compressor discharge. Because the systems are independent, without interconnecting piping, it was assumed that three separate tests would be conducted.
- Phase 5 would occur as one test.

Additional Considerations

- The storage facility would be shut-in for an 8-week period.
- Gas Control could require the storage facility to be online sooner than scheduled for operational integrity.
- High complexity of work could increase bid proposals as compared to other PSEP projects.
- The plan was for day work (Monday through Friday) with no overtime.

Pipeline Safety Enhancement Plan Workpaper Supporting Chapter III
PLAYA DEL REY PHASE 4 & 5 HYDROTEST PROJECT

Cost Avoidance

- By combining Phase 4 and Phase 5, SoCalGas and SDG&E only mobilized the contractor once, thereby reducing costs related to multiple mobilizations.

Pipeline Safety Enhancement Plan Workpaper Supporting Chapter III
PLAYA DEL REY PHASE 4 & 5 HYDROTEST PROJECT

Estimate of Costs

The Phase 2 WOA estimate of the total loaded cost for the PDR Phases 4 and 5 Project was \$2,350,372. Because there was no PSEP estimating tool specifically for Storage projects, this estimate was prepared using the Stage 3 SCG Pipeline Estimate Template Rev 0 estimating tool.

Table 3: PDR Phases 4 and 5 Hydrotest Project 2 WOA Estimate

Cost Category	Phase 2 WOA
Company Labor Costs	\$189,726
Contract Costs	\$1,665,091
Material Costs	\$141,665
Other Direct Costs	\$0
Total Direct Costs	\$1,996,482
Total Indirect Costs	\$353,890
Total Loaded Costs	\$2,350,372

Pipeline Safety Enhancement Plan Workpaper Supporting Chapter III
PLAYA DEL REY PHASE 4 & 5 HYDROTEST PROJECT

Stage 4 – Detailed Engineering Design and Procurement

During Stage 4, detailed design and material procurement was completed in order to provide a construction ready packet to the construction contractor to execute the planned project scope.

Detailed Planning and Design

The PDR Phases 4 & 5 Hydrotest Project consisted of hydrotesting over 35 different pipelines within the PDR Storage Facility. These pipelines are used to inject gas to storage wells. The pipelines interconnect dampeners, compressors, fin fan coolers, and other vital storage facility components. The pipeline to be tested in the storage facility was made up of a complex webbing of pipelines that vary in size, wall thickness and were located in trenches, under floor panels and weaved in and out of the compressor buildings (see figure 3).

In order for the pipelines to be successfully isolated for a complete hydrotest, there was extensive work required to install flanges at strategic locations to allow for temporary removal of rated components that cannot be tested, and to install blind flanges as necessary to test the piping. There were approximately 25 instances where piping had to be disconnected and blind flanges installed. The planning and design stages attempted to account for the complexity of this work, but since the pipelines are located in tight spaces, under floor boards, and on vertical risers, the nature of the work is not completely known until it is being performed.

Due to the high operating pressure of storage facilities, the wall thickness of the pipe that was tested and installed was much greater than standard pipe and this project required additional labor hours beyond what was planned.

Phase 4

During Stage 4, the initial design for PDR was further refined to comprise one test, as opposed to three tests to increase efficiency, save time and reduce costs. This would be achieved by interconnecting the three aforementioned systems utilizing jumper piping.

Pipeline Safety Enhancement Plan Workpaper Supporting Chapter III
PLAYA DEL REY PHASE 4 & 5 HYDROTEST PROJECT

Phase 5

There were no scope changes from Stage 3 to Stage 4.

Construction Contractor Selection

Construction of the PDR Phases 4 & 5 Hydrotest Project utilized the PSEP Performance Partner Program and the mechanical contract was awarded to the Performance Partner selected for this geographic area.

The Performance Partner/Construction Contractor's TPE was \$ [REDACTED], which is \$ [REDACTED] more than the Stage 3 construction contractor direct estimate of \$ [REDACTED] that was used to develop the Phase 2 WOA.

Pipeline Safety Enhancement Plan Workpaper Supporting Chapter III
PLAYA DEL REY PHASE 4 & 5 HYDROTEST PROJECT

Stage 5 – Construction

Schedule

Construction Start Date: 03/11/2015

NOP Date: 05/27/2015

Construction Finish Date: 06/15/2015

Field Conditions

Conditions were encountered in the field that were not anticipated during design and planning that had to be addressed or mitigated. Listed below is a summary of the key field changes for this project:

Schedule:

- Gas Control requested the project be completed in 6 weeks rather than the planned 8 weeks.

Pipeline Safety Enhancement Plan Workpaper Supporting Chapter III
PLAYA DEL REY PHASE 4 & 5 HYDROTEST PROJECT

Figure 3: Exposing Compressor Injection Piping in Preparation for Test



Pipeline Safety Enhancement Plan Workpaper Supporting Chapter III
PLAYA DEL REY PHASE 4 & 5 HYDROTEST PROJECT

Stages 6 and 7 – Commissioning and Closeout

Commissioning activities included site restoration, final inspections and placement of the pipeline back into service, transportation and disposal of the hydrotest water or hazardous materials, and demobilization from the site. Close out activities included development of final drawings, the reconciliation package and updates to company systems to reflect the changes made to the system.

Cost Variance

Table 4: PDR Phases 4 & 5 Hydrotest Project Phase 2 WOA Estimate and Actual Costs

COST SUMMARY				
	PHASE 2 WOA	O&M (actuals)	DELTA over/(under)	
COMPANY LABOR	\$ 189,726	\$ 264,815	\$	75,089
CONTRACT COSTS	\$ 1,665,091	\$ 3,368,025	\$	1,702,934
MATERIALS	\$ 141,665	\$ 234,375	\$	92,710
OTHER DIRECTS	\$ -	\$ 1,103,794	\$	1,103,794
INDIRECTS	\$ 353,890	\$ 365,360	\$	11,470
TOTAL LOADED	\$ 2,350,372	\$ 5,336,370	\$	2,985,998

Table 4 compares the Phase 2 WOA estimate and the March 2016 loaded actual costs.

Because there was no PSEP estimating tool for Storage projects, the estimate was prepared using the Stage 3 SCG Pipeline Estimate Template Rev 0 estimating tool.

The loaded actual cost incurred to complete the PDR Phases 4 and 5 Project was \$5,336,370, which was \$2,985,998 more than the Phase 2 WOA estimate.

The above variance is attributable to scope changes and unanticipated conditions that occurred after the Phase 2 WOA estimate (including: extensive unestimated work to install flanges allocations to allow for temporary removal of rated components that cannot be tested and to install blind flanges as necessary to test the Category 4 piping and additional hours to prepare

Pipeline Safety Enhancement Plan Workpaper Supporting Chapter III
PLAYA DEL REY PHASE 4 & 5 HYDROTEST PROJECT

for testing of this higher operating pressure pipe) and an early cost estimating tool and process that was based on preliminary project designs and not designed to address the complexities of this particular storage facility hydrotest (resulting in underestimation of construction contractor costs, inspection costs, engineering services, project closeout costs, and material costs). These increased costs were reasonably incurred to complete the project, but were not accounted for in the Stage 3 estimate.

Disallowances

For this hydrotest project, SoCalGas and SDG&E have identified pipe as being installed post 1961 and without records that provide the minimum information to demonstrate compliance with regulatory strength testing and recordkeeping requirements then applicable. Of the 0.270 miles of pipeline that was pressure tested, 0.154 miles (57%) of pipe is disallowed. Therefore \$3,067,096 (57%) of the total project O&M costs are acknowledged as a disallowance.

Pipeline Safety Enhancement Plan Workpaper Supporting Chapter III
PLAYA DEL REY PHASE 4 & 5 HYDROTEST PROJECT

Conclusion

SoCalGas and SDG&E enhanced the safety of their natural gas system by prudently executing the PDR Phases 4 & 5 Hydrotest Project. Through this hydrotest project, SoCalGas and SDG&E successfully hydrotested 1,418 feet of pipeline in the community of Playa Del Rey within the city of Los Angeles. The project incurred a total loaded project cost of \$5,336,370.

SoCalGas and SDG&E executed this project prudently: engaging in prudent cost avoidance efforts; working with Gas Control to shut in the facility and minimize customer impacts; and successfully pressure testing a complex webbing of pipelines that vary in size, wall thickness and were located in trenches, under floor panels and weaved in and out of the compressor buildings.

SoCalGas and SDG&E's total loaded project cost of \$5,336,370 is reasonable and should be approved (minus acknowledged disallowances). SoCalGas and SDG&E engaged in prudent cost avoidance efforts (combining Playa Del Rey storage facility hydrotests to realize efficiencies and reduce costs); engaged in reasonable efforts to promote competitive and market-based rates for contractor services and materials (see Chapter II (Phillips) (approximately 98% of PSEP agreements with contractors and suppliers were either competitively bid or through agreements entered into using market-based rates based on a recent competitive sourcing event)); and used a reasonable amount of company and contractor resources given the project's complexity (complex piping configuration at the storage facility) and work scope changes (unestimated work to address the complexity of the facility and associated testing).

End of PDR Phases 4 & 5 Hydrotest Project Workpaper

WP-III-B1 - B2
Facilities Lease Costs

SoCalGas Facilities Lease Costs

MISCELLANEOUS COSTS

Table 1: SoCalGas Facilities Lease Expense Summary (O&M)

Cost Category	Lease Cost
Pico Rivera Auxiliary Lease – PSEP’s allocation of leased off-site classroom to accommodate technical training for field personnel supporting PSEP projects	\$27,900
Regus/31st Floor – short-term lease of Gas Company Tower floor to accommodate PSEP team prior to the availability of 22nd floor	\$82,906
22nd/23rd Floor – lease and related expenses associated with the 22nd and 23rd Floor of the Gas Company Tower to accommodate PSEP personnel.	\$5,762,150
Other Costs	(\$320,335)
Total	\$5,552,621

Table 2: SoCalGas Facilities Lease Expense Detail (O&M)

Cost Category	Base Rent	Maintenance	Parking	Property Tax	Other Costs	Total
Pico Rivera Auxiliary Lease (10/12 – 9/15)	\$27,900					\$27,900
Regus/31st Floor (3/13 – 6/13)	\$43,331	\$39,575				\$82,906
Maguire – 22nd Floor (7/13 – 4/16)	\$1,758,039	\$802,997	\$471,184	\$220,637		\$3,252,857
Maguire – 23rd Floor (3/14 – 4/16)	\$1,322,591	\$610,789	\$355,276	\$220,637		\$2,509,293
Reversal of A&G loader allocation. This adjustment will be discussed in the Revenue Requirement Testimony by Reggie Austria.					(\$216,935)	(\$216,935)
GMA Journal Entry – credit due to incorrect adjustment. Journal entry posted in June. Net effect should be zero.					(\$103,399)	(\$103,399)
Total	\$3,151,861	\$1,453,361	\$826,460	\$441,274	(\$320,335)	\$5,552,621

SDG&E Facilities Lease Costs

MISCELLANEOUS COSTS

Table 1: SDG&E Facilities Lease Expense Summary (O&M)

Cost Category	Lease Cost
Shoreham Viewridge– lease and related expenses to accommodate PSEP personnel	\$221,824
Other Charges	\$463,318
Total	\$685,142

Table 2: SDG&E Facilities Lease Expense Detail (O&M)

Cost Category	Base Rent	Maintenance	Other Costs	Amount
Shoreham Viewridge Lease-Building (5/14 – 1/16)	\$213,511	\$8,313		\$221,824
Other Charges			\$463,318	\$463,318
Total	\$213,511	\$8,313	\$463,318	\$685,142

Table 3: Other Charges Detail (O&M)

Cost Category	Amount	Notes
Accruals	\$52,714	Accruals
Office Supplies	\$75,203	Office Supplies and Printing Costs & Services
Overheads	\$6,887	Overhead Costs
Telecom & Network Services	\$91,229	Internet Service Provider and Networking Hardware
Furniture & Accessories	\$176,188	Office furniture rental
Miscellaneous Services	\$61,097	Fleet Costs, Legal Services, and Other Professional services for the building
Total	\$463,318	

WP-III-C1
Descoped Projects

SoCalGas Descoped Project Costs

Miscellaneous Costs

Table 1: Descoped Project Costs (000's)

Cost Category	35-20-A	38-523	41-6045	41-80	Grand Total
Company Labor	\$14	\$7	\$7	\$5	\$33
Contract Costs	\$1	\$43	\$15	\$1	\$60
Materials	\$0	\$0	\$10	\$0	\$10
Other Directs	\$2	\$8	\$16	\$36	\$62
Indirect Costs	\$11	\$11	\$8	\$4	\$34
Total	\$28	\$69	\$56	\$46	\$199

WP-III-D1 - D3
Post Completion Cost Adjustments

SoCalGas Post-Completion Adjustment Costs

Miscellaneous Costs

Table 1: Post-Completion Adjustment Costs Summary

Cost Category	Line 2000-A O&M & Cap ¹	42-66-1/42-66-2 ²	Playa Del Rey (Phases 1-3)	SL 38-528	Line 41-04-1	Line 2001 East	Facilities Build-Out Costs ³	Total
Contractor Invoices	\$141,723	\$(2,378)	\$81,181	\$0	\$3,944	\$7,078	\$158,497	\$390,045
Company Labor/ JE Adjustments	\$32,723	\$11,589	\$1,599	\$1720	\$0	\$3,163	\$0	\$50,794
Accrual Reversals	\$(81,481)	\$0	\$0	\$0	\$0	\$0	\$(66,599)	\$(148,080)
Other	\$22,206	\$7,607	\$(15,734)	\$598	\$31	\$2,974	\$10,098	\$27,780
Total	\$115,171	\$16,818	\$67,046	\$2,318	\$3,975	\$13,215	\$101,996	\$320,539⁴

¹ The Line 2000-A Post-Completion Adjustment Costs of \$115,171 = \$285,331 (O&M) + \$(167,160) (Capital).

² The 42-66-1/42-66-2 Post-Completion Adjustment Costs of \$16,818 is Capital.

³ The Facilities Build-Out Post-Completion Adjustment Costs of \$101,996 is Capital.

⁴Total varies from Testimony due to rounding.

Post-Completion Adjustment Costs: Line 2000-A O&M

Cost Category	Line 2000-A O&M	Cost Driver
Contractor Invoices	\$188,640	Main Driver Includes Contractor Costs \$135k and GMA Costs of \$53k
Company Labor/ JE Adjustments	\$58,068	Includes (1) Company Labor of \$25k (2) GMA costs of \$26k and (3) Electrician Cost of \$7k
Accrual Reversals	\$(14,607)	Accrual Reversals
Other	\$50,230	Overhead Costs
Total	\$282,331	

Post-Completion Adjustment Costs: Line 2000-A Capital

Cost Category	Line 2000-A Capital	Cost Driver
Contractor Invoices	\$(46,917)	Main Driver Includes Contractor Costs \$124k and GMA Costs of -\$72k
Company Labor/ JE Adjustments	\$(25,345)	Includes Company Labor of \$11k and GMA Costs of -\$36k
Accrual Reversals	\$(66,874)	Accrual Reversals
Other	\$(28,024)	Overhead Costs
Total	\$(167,160)	

SoCalGas Post-Completion Adjustment Costs

Post-Completion Adjustment Costs: 42-66-1/42-66-2

Cost Category	42-66-1/42-66-2	Cost Driver
Contractor Invoices	\$(2,378)	Includes GMA Cost of -\$2.4k
Company Labor/JE Adjustments	\$11,589	Includes Company Labor of \$13k and GMA Costs of -\$1.2k
Accrual Reversals	\$0	
Other	\$7,607	Overhead Costs
Total	\$16,818	

Post-Completion Adjustment Costs: Playa Del Rey (Phases 1–3)

Cost Category	Playa Del Rey (Phases 1–3)	Cost Driver
Contractor Invoices	\$81,181	Includes Contractor and Material Cost of \$81k
Company Labor/JE Adjustments	\$1,599	Includes Company Labor Costs of \$2k
Accrual Reversals	\$0	
Other	\$(15,734)	Overhead Costs of \$4.3k and Disallowance for Post-1961 PSEP Costs of \$20k
Total	\$67,046⁴	

⁴ \$67,046 is the net cost submitted for recovery after deducting Post-1961 footage without sufficient record of a pressure test to 1.25 MAOP (23% of total PSEP footage and costs) consistent with the original submittal for cost recovery in A.14-12-016 (See Chapter III, Amended Prepared Testimony of Rick Phillips, A.14-12-016, pg. 9)

Post-Completion Adjustment Costs: SL 38-528

Cost Category	SL 38-528	Cost Driver
Contractor Invoices	\$0	
Company Labor/JE Adjustments	\$1,720	GMA Allocations
Accrual Reversals	\$0	
Other	\$598	Overhead Costs
Total	\$2,318	

SoCalGas Post-Completion Adjustment Costs

Post-Completion Adjustment Costs: Line 41-04-I

Cost Category	Line 41-04-I	Cost Driver
Contractor Invoices	\$3,944	██████████ was included in the Chapter 3 filed costs but it was not incurred, resulting in an excess adjustment Cost of \$4k
Company Labor/JE Adjustments	\$0	
Accrual Reversals	\$0	
Other	\$31	Overhead Costs
Total	\$3,975	

Post-Completion Adjustment Costs: Line 2001 East

Cost Category	Line 2001 East	Cost Driver
Contractor Invoices	\$7,078	Contractor Invoice from ██████████ of \$242 and ██████████ of \$7k
Company Labor/JE Adjustments	\$3,163	Includes Company Labor Costs of \$3k
Accrual Reversals	\$0	
Other	\$2,974	Overhead Costs
Total	\$13,215	

Post-Completion Adjustment Costs: 23rd Floor Build-Out Costs

Cost Category	23 rd Floor Build-Out Costs	Cost Driver
Contractor Invoices	\$158,497	Main drivers includes Contractor Costs for build-out by ██████████ of \$119k, ██████████ of \$58k, & a tenant improvement Credit of -\$36k
Company Labor/JE Adjustments	\$0	
Accrual Reversals	\$(66,599)	Accrual Reversals
Other	\$10,098	Overhead Costs
Total	\$101,996	

WP-V-A1 - A204
Valve Projects

WP-V-A1 - A204
Valve Projects

Bundle	WOA DATE	Scope	Workpaper Page
Arrow & Haven	9/9/2013	1 valve	WP-V-A1 – A12
Bain St	9/10/2013	2 valves	WP-V-A13 – A25
Brea	5/2/2014	1 valve	WP-V-A26 – A36
Chino	9/26/2013	5 valves	WP-V-A37 – A49
Haskell	9/26/2013	2 valves	WP-V-A50 – A62
Moreno - Large	9/10/2013	1 FM	WP-V-63 – A76
Moreno - Small	9/10/2013	1 valve/1 FM	WP-V-A77 – A89
Pixley	6/4/2014	3 valves	WP-V-A90 – A101
Prado	9/18/2013	5 valves	WP-V-A102 – A113
Puente	1/30/2014	2 CV's	WP-V-A114 – A123
Santa Fe Springs	9/15/2013	3 valves	WP-V-A124 – A135
SGV Fern & Walnut	5/22/2014	3 valves	WP-V-A136 – A151
Victoria	5/21/2014	3 valves/1 FM	WP-V-A152 – A166
Whitewater	9/18/2013	3 valves	WP-V-A167 – A178
Palmdale with L-235 and SL 44-654	9/1/13, 9/19/13, 12/17/13	6 valves with Transmission and Distribution Piping	WP-V-A179 – A204

Pipeline Safety Enhancement Plan Workpaper Supporting Chapter V
ARROW & HAVEN VALVE PROJECT

Summary

Table 1: Arrow & Haven Valve Project

Project Name	Arrow & Haven Valve Project
WOA Number	91029
WOA Date	September 9, 2013
City	Rancho Cucamonga
Construction Start	05/12/2014
NOP Date	12/19/2014
Total Loaded Capital Costs	\$1,157,969
Total Loaded O&M Costs	\$ 0
Total Loaded Project Costs	\$1,157,969

Description

Through the Arrow & Haven Valve Project, SoCalGas and SDG&E enhanced its gas transmission system by upgrading one valve, as shown in Table 2 and Figure 1. This valve enhancement is summarized as follows:

- Mainline Valve 4000-85.88-0 along Line 4000 was upgraded to include a standard PSEP technology suite enabling both ASV and RCV functionality.
- A new vault was installed to replace the existing vault, which was not large enough to house the new actuator.

Examples of cost avoidance actions included:

- The Arrow & Haven Valve Project was one of nine projects that were combined into a comprehensive bid package for a mechanical and electrical contractor in order to capture efficiencies because the contractors were able to perform work simultaneously at the various sites and could manage work load between projects.

Pipeline Safety Enhancement Plan Workpaper Supporting Chapter V
ARROW & HAVEN VALVE PROJECT

- Strength testing for small diameter pipe for the Arrow & Haven Valve Project was combined with pipe strength testing activities for the Whitewater Station Valve Project for efficiency purposes.

Construction began in May 2014 and was completed in February 2015. The Arrow & Haven Valve Project incurred a total loaded project cost of \$1,157,969.

Table 2: Arrow & Haven Valve Project Final Scope

Line	Valve ID	Valve Type	Installation Type	Function	Valve Size (Inches)
4000	4000-85.88-0	Ball	A/VT	ASV/RCV	■

Pipeline Safety Enhancement Plan Workpaper Supporting Chapter V
ARROW & HAVEN VALVE PROJECT

Figure 1: Satellite Image of Arrow & Haven Valve Project



Pipeline Safety Enhancement Plan Workpaper Supporting Chapter V
ARROW & HAVEN VALVE PROJECT

Stages 1 and 2 - Project Initiation

Table 3: 2011 PSEP Filing

2011 PSEP Filing						
Line	Mile	Valve #	Valve ID	Valve Size (inches)	Installation Type	Function
4000	85.88	0	4000-85.88-0	█	C/P	ASV/RCV

In the workpapers supporting the 2011 PSEP filing,¹ SoCalGas and SDG&E identified mainline valve 4000-85.88-0 as a PSEP valve enhancement project. The project is located near the intersection of Haven Avenue and Arrow Route in the City of Rancho Cucamonga and provides isolation of pipeline segments in the event of an emergency.

Table 4: Arrow & Haven Valve Project Stage 1 and 2 Scope

2011 PSEP Filing						
Line	Mile	Valve #	Valve ID	Valve Size (inches)	Installation Type	Function
4000	85.88	0	4000-85.88-0	█	A/VT	ASV/RCV

During Stages 1 and 2, SoCalGas and SDG&E completed scope validation, detailed scope development, and initial project coordination tasks to prepare for engineering, design, and construction of the Arrow & Haven Valve Project.

The scope validation review of documentation related to the Arrow & Haven Valve Project and site visits indicated that:

- The existing actuator was incompatible with the new control system.
- Utility power and data communications were not available at the site.

¹ See December 2, 2011, Amended Pipeline Safety Enhancement Plan (PSEP) of SoCalGas and SDG&E.

Pipeline Safety Enhancement Plan Workpaper Supporting Chapter V
ARROW & HAVEN VALVE PROJECT

SoCalGas and SDG&E conducted an in-depth site evaluation, including a field visit, and further reviewed the existing drawings. Through engineering analysis, SoCalGas and SDG&E determined long lead item and communication and power needs, and refined the scope as follows:

- Installation type for Mainline Valve 4000-85.88-0 changed from C/P to A/VT because the existing actuator was not compatible with the PSEP ASV automation design. Also, a larger vault was needed for the new actuator.

Pipeline Safety Enhancement Plan Workpaper Supporting Chapter V
ARROW & HAVEN VALVE PROJECT

Stage 3 – Initial Detailed Planning and Design

During Stage 3, SoCalGas and SDG&E developed a Phase 2 WOA estimate, completed preliminary design drawings and further refined the scope. Preliminary drawings were also used to initiate procurement of long lead materials.

Planning and Design Activity

The design for the Arrow & Haven Valve Project was planned as follows:

Mainline Valve 4000-85.88-0

- Remove incompatible ASV equipment and actuator.
- Install new line break control panel equipped with standardized PSEP ASV technology.
- Install new SCADAPack panel equipped with remote control technology.
- Install new actuator.
- Install new vault for actuator.

Cost Avoidance

- A comprehensive bid package was created for nine projects which included the Arrow and Haven Valve Project. They were combined into one comprehensive bid package for a mechanical and electrical contractor in order to capture efficiencies because the contractors would be able to perform work simultaneously at the various sites and could manage work load between projects more effectively.
- The plan was to combine strength testing of the small diameter pipe for the Arrow & Haven Valve Project along with Whitewater Station Valve Project for efficiency purposes.

Pipeline Safety Enhancement Plan Workpaper Supporting Chapter V
ARROW & HAVEN VALVE PROJECT

Estimate of Total Costs

The Phase 2 WOA estimate of the total loaded cost to complete the scope of work for the Arrow & Haven Valve Project as described above was \$1,149,223, as shown in Table 5. This estimate was prepared in September 2013 using the Stage 3 SCG Valve Estimate Template Rev Beta estimating tool and is based on preliminary design work.

Table 5: Arrow & Haven Valve Project Phase 2 WOA Estimate

Cost Category	Phase 2 WOA
Company Labor Costs	\$123,315
Contract Costs	\$130,706
Material Costs	\$292,204
Other Direct Costs	\$378,744
Total Direct Costs	\$924,969
Total Indirect Costs	\$224,255
Total Loaded Cost	\$1,149,223

Pipeline Safety Enhancement Plan Workpaper Supporting Chapter V
ARROW & HAVEN VALVE PROJECT

Stage 4 – Detailed Engineering Design and Procurement

During Stage 4, SoCalGas and SDG&E developed and completed detailed engineering design work, selected a construction contractor, and prepared for project construction.

Detailed Planning and Design

There were no scope changes from Stage 3 to Stage 4

Construction Contractor Selection

Both a mechanical contractor and an electrical contractor are needed to complete construction of valve enhancement projects. In order to achieve cost and schedule efficiencies, SoCalGas and SDG&E identified nine valve projects that could be combined into two comprehensive bid packages, one for mechanical contractor services and one for electrical contractor services. The nine sites that were combined in this fashion were the Arrow & Haven project; and the Bain, Chino, Haskell, Moreno Large, Moreno Small, Prado, Santa Fe Springs, and Whitewater stations.

The construction contractors' bid was \$ [REDACTED], which was \$ [REDACTED] more than the Stage 3 construction contractor direct estimate of \$ [REDACTED] that was used to develop the Phase 2 WOA.

Pipeline Safety Enhancement Plan Workpaper Supporting Chapter V
ARROW & HAVEN VALVE PROJECT

Stage 5 - Construction

Schedule

Construction Start Date: 05/12/2014

NOP Date: 12/19/2014

Construction Finish Date: 02/16/2015

The NOP was delayed for the Arrow & Haven Valve Project due to a delay associated with the local electric utility provision of power to the site.

Field Conditions

Conditions were encountered in the field that were not anticipated during design and planning that had to be addressed or mitigated. Listed below is a summary of the key field changes broken down by type of change for this project:

Equipment Conditions: Once the construction team was on-site and preparing to install the new equipment, design improvements were determined to be necessary:

- Additional installation of ¾-in. pipe to prevent installing tubing below grade.
- Additional borings in the vault to accommodate the piping.
- Contractor had to redesign the actuator extension in the field after the vault was demolished to fully expose the valve extension.
- Installation of an antenna pole to enable wireless communications for remote control capability.

Pipeline Safety Enhancement Plan Workpaper Supporting Chapter V
ARROW & HAVEN VALVE PROJECT

Traffic Control:

- Because this project was located within city streets, certain traffic control and safety measures required changes based on evolving conditions in the field with respect to contractor truck locations and crane needs.

Substructures:

- An unforeseen abandoned valve and related piping was found during construction requiring removal in order to accommodate the new equipment.

Safety:

- Additional safety measures were required to barricade the excavation on a nearby slope.

Pipeline Safety Enhancement Plan Workpaper Supporting Chapter V
ARROW & HAVEN VALVE PROJECT

Stages 6 and 7 – Commissioning and Closeout

Commissioning activities included site restoration, final inspections, and placement of the valves back into service. During this stage, SoCalGas and SDG&E successfully performed site acceptance testing and conducted point-to-point verification with SoCalGas Gas Control for each valve that had been automated. SoCalGas Field Operations personnel were trained on the use of new equipment. Close out activities included development of final drawings, the reconciliation package and updates to company systems to reflect the changes made to the system.

Cost Variance

Table 6: Arrow & Haven Valve Project Phase 2 WOA Estimate and Actual Costs

COST SUMMARY				
	PHASE 2 WOA	CAPITAL (actuals)	DELTA over/(under)	
COMPANY LABOR	\$ 123,315	\$ 125,981	\$	2,666
CONTRACT COSTS	\$ 130,706	\$ 320,228	\$	189,522
MATERIALS	\$ 292,204	\$ 153,842	\$	(138,362)
OTHER DIRECTS	\$ 378,744	\$ 364,929	\$	(13,815)
INDIRECTS	\$ 224,254	\$ 192,989	\$	(31,265)
TOTAL LOADED	\$ 1,149,223	\$ 1,157,969	\$	8,746

Table 6 compares the preliminary Phase 2 WOA estimate and the March 2016 loaded actual costs. The loaded actual costs exceeded the Phase 2 WOA estimate by \$8,746.

The above variance is attributable to scope changes and unanticipated conditions that occurred after the Phase 2 WOA estimate (see above), overestimation of the costs for materials, and underestimation of the costs for project support and engineering design services. The increased costs were reasonably incurred to complete the valve enhancement, but were not accounted for in the Stage 3 estimate.

Pipeline Safety Enhancement Plan Workpaper Supporting Chapter V
ARROW & HAVEN VALVE PROJECT

Conclusion

SoCalGas and SDG&E enhanced the safety of their natural gas system by prudently executing the Arrow & Haven Valve Project. Through this valve enhancement project, SoCalGas and SDG&E successfully upgraded one valve and replaced a vault to accommodate the new automation equipment associated with the upgraded valve. The project incurred a total loaded project cost of \$1,157,969.

SoCalGas and SDG&E executed this project prudently by coordinating and bundling nine valve projects into a comprehensive bid package in order to capture efficiencies and responded to numerous unanticipated field changes including unanticipated site conditions, necessary field adjustments, and design changes.

SoCalGas and SDG&E's total loaded project cost of \$1,157,969 is reasonable and should be approved. SoCalGas and SDG&E engaged in prudent cost avoidance efforts (coordinating valve projects to realize efficiencies); engaged in reasonable efforts to promote competitive and market-based rates for contractor services and materials (see Chapter II (Phillips) (approximately 98% of PSEP agreements with contractors and suppliers were either competitively bid or through agreements entered into using market-based rates based on a recent competitive sourcing event)); and used a reasonable amount of company and contractor resources given the conditions and work scope changes experienced during construction.

End of Arrow and Haven Valve Workpaper

Pipeline Safety Enhancement Plan Workpaper Supporting Chapter V
BAIN STREET STATION VALVE PROJECT

Summary

Table 1: Summary of Bain Street Station Valve Project

Project Name	Bain Street Station Valve Project
WOA Number	91028
WOA Date	September 10, 2013
City	Riverside
Construction Start	December 10, 2013
NOP Date	June 11, 2014
Total Loaded Capital Costs	\$1,063,539
Total Loaded O&M Costs	\$ 0
Total Loaded Project Costs	\$1,063,539

Description

Through the Bain Street Station Valve Project, SoCalGas and SDG&E enhanced its gas transmission system by upgrading two valves, as shown in Table 2 and Figure 1. These two valve enhancements are summarized as follows:

- Mainline Valve 2001-179.65-0 along Line 2001 was upgraded to include a standard PSEP technology suite enabling both ASV and RCV functionality.
- Bridle Valve 2001-179.65-1 was upgraded with an actuator and remote control capability.

Example of cost avoidance actions included:

- The Bain Street Station Valve Project was one of nine projects that were combined into a comprehensive bid package for a mechanical and electrical contractor in order to capture efficiencies because the contractors were able to perform work simultaneously at the various sites and could manage work load between projects.

Pipeline Safety Enhancement Plan Workpaper Supporting Chapter V
BAIN STREET STATION VALVE PROJECT

-

Construction began in December 2013 and was completed in February 2014. The Bain Street Station Valve Project incurred a total loaded project cost of \$1,063,539.

Table 2: Bain Street Station Valve Project Final Scope

Line	Valve ID	Valve Type	Installation Type	Function	Valve Size (inches)
2001	2001-179.65-0	Ball	CP	ASV/RCV	■
2001	2001-179.65-1	Ball	A/AG	RCV	■

Pipeline Safety Enhancement Plan Workpaper Supporting Chapter V
BAIN STREET VALVE PROJECT

Figure 1: Satellite Image of Bain Street Valve Station Project



Pipeline Safety Enhancement Plan Workpaper Supporting Chapter V
BAIN STREET STATION VALVE PROJECT

Stages 1 and 2 – Project Initiation

Table 3: 2011 PSEP Filing

2011 PSEP Filing						
Line	Mile	Valve #	Valve ID	Valve Size (inches)	Installation Type	Function
2001	179.65	0	2001-179.65-0	■	ASV/RCV	ASV/RCV

In work papers supporting the 2011 PSEP filing,¹ SoCalGas and SDG&E identified mainline valve 2001-179.65-0 as a PSEP valve retrofit project. This mainline valve is located at the Bain Street Station in the city of Riverside and provides isolation of transmission pipeline segments in the event of an emergency.

Table 4: Bain Street Station Valve Project Stage 1 and 2 Scope

Stage 1 and 2 Scope						
Line	Mile	Valve #	Valve ID	Valve Size (inches)	Valve Type	Function
2001	179.65	0	2001-179.65-0	■	Ball	ASV/RCV
2001	179.65	1	2001-179.65-1	■	Ball	RCV

During Stages 1 and 2, SoCalGas and SDG&E completed scope validation, detailed scope development and initial project coordination tasks to prepare for engineering, design, and construction associated with the Bain Street Station Valve Project.

¹ See December 2, 2011, Amended Pipeline Safety Enhancement Plan (PSEP) of SoCalGas and SDG&E.

Pipeline Safety Enhancement Plan Workpaper Supporting Chapter V

BAIN STREET STATION VALVE PROJECT

- In 2011, the mainline valve 2001-179.65-0 located at Bain Street Station, was identified in SoCalGas and SDG&E's PSEP workpapers as a PSEP valve enhancement project.
- Mainline Valve 2001-179.65.0 had two accompanying crossover valves on the bridle assembly: 2001-179.65-1 (upstream) and 2001-179.65-2 (downstream).

The scope validation review of documentation related to the Bain Street Station Valve Project and site visits indicated that:

- The Bain Street Station was first installed in 1949 and was retrofitted by SoCalGas Pipeline Integrity in 2004, at which time all three valves were replaced with ball valves in order to accommodate the use of in-line inspection technology.
- Mainline Valve 2001-179.65-0 was automated, but with a control scheme that did not have the full functionality required for PSEP control strategy across the pipeline system. This includes having both ASV/RCV control functionality and enhanced features to minimize system impacts in the event of emergency. The valve was normally in the open position.
- Bridle Valve 2001-179.65-1 was manually operated and was normally in the open position.
- Bridle Valve 2001-179.65-2 was manually operated and was normally in the closed position.

SoCalGas and SDG&E conducted an in-depth site evaluation, including a field visit, and further reviewed the existing drawings. Through engineering analysis, SoCalGas and SDG&E determined long lead items; communication and power needs, and made the following scope modifications:

- Because Bridle Valve 2001-179.65-2 is normally in the closed position, preventing flow from Line 2001 to Line 5000 and creating the required isolation, this valve was not determined to be necessary for the project.

Pipeline Safety Enhancement Plan Workpaper Supporting Chapter V
BAIN STREET STATION VALVE PROJECT

- The installation of a fiberglass panel shelter was added to the scope of the project to protect electrical and control equipment.

Pipeline Safety Enhancement Plan Workpaper Supporting Chapter V
BAIN STREET STATION VALVE PROJECT

Stage 3 – Initial Planning and Design

During Stage 3, SoCalGas and SDG&E developed a Phase 2 WOA estimate, completed preliminary design drawings and further refined the scope. Preliminary drawings were also used to initiate procurement of long lead materials.

Planning and Design Activity

The design for Bain Street Station Valve Project was planned as follows:

Mainline Valve 2001-179.65-0

- Install new line break control panel equipped with standardized PSEP ASV technology.
- Install a SCADAPack panel equipped with remote control technology.
- Install fiberglass panel shelter for electrical and control equipment.
- Install associated tubing, conduit, cable, utility power, and data communications.
- Retain the existing actuator as it did not require replacement.

Bridle Valve 2001-179.65-1

- Install pneumatic actuator and instrumentation.
- Install associated tubing, conduit, and cable.

Cost Avoidance

- A comprehensive bid package was created for nine projects which included the Bain Street Station Valve Project. They were combined into one comprehensive bid package for a mechanical and electrical contractor in order to capture efficiencies because the contractors would be able to perform work simultaneously at the various sites and could manage work load between projects more effectively.

Pipeline Safety Enhancement Plan Workpaper Supporting Chapter V
BAIN STREET STATION VALVE PROJECT

Estimate of Costs

The Phase 2 WOA estimate for the total loaded cost to complete the scope of work for the Bain Street Station Valve Project as described above was \$813,865, as shown in Table 5. This estimate was prepared in September 2013 using the Stage 3 SCG Valve Estimate Template Rev Beta estimating tool and is based on preliminary design work.

Table 5: Bain Street Station Valve Project Phase 2 WOA Estimate

Cost Category	Phase 2 WOA
Company Labor Costs	\$85,335
Contract Costs	\$163,785
Material Costs	\$123,660
Other Direct Costs	\$287,147
Total Direct Costs	\$659,927
Total Indirect Costs	\$153,938
Total Loaded Costs	\$813,865

Pipeline Safety Enhancement Plan Workpaper Supporting Chapter V
BAIN STREET STATION VALVE PROJECT

Stage 4 – Detailed Engineering Design and Procurement

During Stage 4, SoCalGas and SDG&E developed and completed detailed engineering design work, selected a construction contractor and prepared for project construction.

Detailed Planning and Design

No scope changes occurred from Stage 3 to Stage 4.

Construction Contractor Selection

Both a mechanical contractor and an electrical contractor are needed to complete construction of valve enhancement projects. In order to achieve cost and schedule efficiencies, SoCalGas and SDG&E identified nine valve projects that could be combined into two comprehensive bid packages, one for mechanical contractor services and one for electrical contractor services. The nine sites that were combined in this fashion were the Arrow & Haven project; and the Bain, Chino, Haskell, Moreno Large, Moreno Small, Prado, Santa Fe Springs and Whitewater stations.

The construction contractors' bid was \$ [REDACTED] which is \$ [REDACTED] less than the Stage 3 construction contractor direct estimate of \$ [REDACTED] that was used to develop the Phase 2 WOA.

Pipeline Safety Enhancement Plan Workpaper Supporting Chapter V
BAIN STREET STATION VALVE PROJECT

Stage 5 – Construction

Schedule

Construction Start:	12/10/2013
Construction Finish:	02/24/2014
NOP Date:	06/11/2014

There were no delays affecting the construction schedule. However, the NOP date was delayed due to due to length of time it took to resolve technical issues with the telecommunications provider's data communications circuit.

Field Conditions

Conditions were encountered in the field that were not anticipated during design and planning that had to be addressed or mitigated. Listed below is a summary of the key field changes broken down by type of change for this project:

Equipment Conditions: Once the construction team was on-site and preparing to install the new equipment, design improvements were determined to be necessary:

- Installation of an additional tap to sense pressure for improved accuracy.
- Installation of an additional pressure transmitter for the actuator to provide additional SCADA information.
- Installation of a canopy over the panel for weather protection.
- Installation of internal shelter lighting and a power distribution panel.

Pipeline Safety Enhancement Plan Workpaper Supporting Chapter V
BAIN STREET STATION VALVE PROJECT

Safety:

- Potholing activities were determined to be necessary to confirm location of pipeline in order for project work to be safely performed and to protect existing facilities.

Pipeline Safety Enhancement Plan Workpaper Supporting Chapter V
BAIN STREET STATION VALVE PROJECT

Stages 6 and 7 – Commissioning and Closeout

Commissioning activities included site restoration, final inspections, and placement of the valves back into service. During this stage, SoCalGas and SDG&E successfully performed site acceptance testing and conducted point-to-point verification with SoCalGas Gas Control for each valve that had been automated. SoCalGas Field Operations personnel were trained on the use of new equipment. Close out activities included development of final drawings, the reconciliation package and updates to company systems to reflect the changes made to the system.

Cost Variance

Table 6: Bain Street Station Valve Project Phase 2 WOA Estimate and Actual Costs

COST SUMMARY				
	PHASE 2 WOA	CAPITAL (actuals)	DELTA over/(under)	
COMPANY LABOR	\$ 85,335	\$ 144,358	\$	59,023
CONTRACT COSTS	\$ 163,785	\$ 240,263	\$	76,478
MATERIALS	\$ 123,660	\$ 116,007	\$	(7,653)
OTHER DIRECTS	\$ 287,147	\$ 382,304	\$	95,157
INDIRECTS	\$ 153,938	\$ 180,606	\$	26,668
TOTAL LOADED	\$ 813,865	\$ 1,063,539	\$	249,674

Table 6 compares the Phase 2 WOA estimate and the March 2016 loaded actual costs. The loaded actual costs exceeded the Phase 2 WOA by \$249,674.

The above variance is attributable to scope changes and unanticipated conditions that occurred after the Phase 2 WOA estimate (see above) and an early version of the cost estimating tool and process that was based on preliminary design work (resulting in underestimation of labor, electrical and mechanical contractor, and support services costs). These increased costs were reasonably incurred to complete the valve enhancement, but were not accounted for in the Stage 3 estimate.

Pipeline Safety Enhancement Plan Workpaper Supporting Chapter V
BAIN STREET STATION VALVE PROJECT

Conclusion

SoCalGas and SDG&E enhanced the safety of their natural gas system by prudently executing the Bain Street Station Valve Project. Through this valve enhancement project, SoCalGas and SDG&E successfully upgraded two valves. The project incurred a total loaded project cost of \$1,063,539.

SoCalGas and SDG&E executed this project prudently by coordinating and bundling nine valve projects into a comprehensive bid package in order to capture efficiencies and responded to numerous unanticipated field changes including unanticipated site conditions, necessary field adjustments, and design changes.

SoCalGas and SDG&E's total loaded project cost of \$1,063,539 is reasonable and should be approved. SoCalGas and SDG&E engaged in prudent cost avoidance efforts (coordinating valve projects to realize efficiencies); engaged in reasonable efforts to promote competitive and market-based rates for contractor services and materials (see Chapter II (Phillips) (approximately 98% of PSEP agreements with contractors and suppliers were either competitively bid or through agreements entered into using market-based rates based on a recent competitive sourcing event)); and used a reasonable amount of company and contractor resources given the conditions and work scope changes experienced during construction.

End of Bain Street Station Valve Workpaper

Pipeline Safety Enhancement Plan Workpaper Supporting Chapter V
BREA STATION - 1013 VALVE PROJECT

Summary

Table 1: Summary of Brea Station – 1013 Valve Project

Project Name	Brea Station - 1013 Valve Project
WOA Number	91058
WOA Date	May 2, 2014
City	Brea
Construction Start	October 1, 2014
NOP Date	December 15, 2014
Total Loaded Capital Costs	\$ 295,027
Total Loaded O&M Costs	\$ 0
Total Loaded Project Costs	\$ 295,027

Description

Through the Brea Station - 1013 Valve Project, SoCalGas and SDG&E enhanced its gas transmission system by upgrading Mainline Valve 1013-0.00-0 along Line 1013 to modernize the valve technology and enable both ASV and RCV functionality, as shown in Table 2 and Figure 1.

Example of cost avoidance actions included:

- The Brea Station - 1013 Valve Project coordinated its construction with the Line 1013 PSEP pipeline replacement project for construction efficiency purposes.

Construction began in October 2014 and was completed in December 2014. The total loaded project cost incurred by SoCalGas and SDG&E to complete the Brea Station - 1013 Valve Project is \$295,027.

Table 2: Brea Station – 1013 Valve Project Final Scope

Line	Valve ID	Valve Type	Installation Type	Function	Valve Size
1013	1013-0.00-0	Ball	A/AG	ASV/RCV	██████

Pipeline Safety Enhancement Plan Workpaper Supporting Chapter V
BREA STATION - 1013 VALVE PROJECT

Figure 1: Satellite Image of Brea Station – 1013 Valve Project



Pipeline Safety Enhancement Plan Workpaper Supporting Chapter V
BREA STATION - 1013 VALVE PROJECT

Stages 1 and 2 – Project Initiation

Table 3: 2011 PSEP Filing

2011 PSEP Filing					
Line	Mile	Valve ID	Valve Size	Installation Type	Function
1013	0	1013-0.00-0	██████	ASV/RCV	ASV/RCV

In workpapers supporting the 2011 PSEP filing,¹ SoCalGas and SDG&E identified mainline valve 1013-0.00-0 as a PSEP valve retrofit project. This mainline valve is located at the Brea Station in the City of Brea (Figure 1) and provides isolation of transmission pipeline segments in the event of an emergency.

Table 4: Brea Station – 1013 Valve Project Stage 1 and 2 Scope

Stage 1 & 2 Scope						
Line	Mile	Valve #	Valve ID	Valve Size	Installation Type	Function
1013	0	0	1013-0.00-0	██████	A/AG	ASV/RCV

With the knowledge that this valve was part of the PSEP valve enhancement project, the valve was replaced as part of the project execution activity on Line 1013 Replacement Project prior to initiation of this project. The Brea Station - 1013 Valve Project added automation technology to the valve.² As a result, SoCalGas and SDG&E reduced the scope for the Brea Station - 1013 Valve Project to an A/AG installation, which automated the valve that was installed as part of the pipeline project. The updated scope is reflected in Table 4.

¹ See December 2, 2011, Amended Pipeline Safety Enhancement Plan (PSEP) of SoCalGas and SDG&E.

² The cost of the actual valve is included in the L-1013 Replacement Project estimate and final costs.

Pipeline Safety Enhancement Plan Workpaper Supporting Chapter V
BREA STATION - 1013 VALVE PROJECT

Automation of this valve enhances the transmission valve system by enabling SoCalGas and SDG&E to provide isolation between Line 1013 and Line 2000 in the event of a pipeline failure or other emergency.

Since the mainline valve had been replaced as part of the Line 1013 replacement project, review of historic records was not necessary and Stage 1 and 2 scope validation efforts were not required. Accordingly, the project progressed to Stage 3 shortly after initiation.

Pipeline Safety Enhancement Plan Workpaper Supporting Chapter V
BREA STATION - 1013 VALVE PROJECT

Stage 3 – Initial Planning and Design

During Stage 3, SoCalGas and SDG&E developed a Phase 2 WOA estimate, completed preliminary design drawings and further refined the scope. Preliminary drawings were also used to initiate procurement of long lead materials.

Planning and Design Activity

The following work was considered in the design of this project:

Mainline Valve 1013-0.00-0

- Install actuator and instrumentation.
- Install new line break control panel equipped with standardized PSEP ASV technology.
- Install SCADAPack panel equipped with remote control technology.
- Install associated tubing, conduit, cable, utility power, and data communications.

Estimate of Costs

The preliminary estimate of the total loaded cost to complete the scope of work for the Brea Station - 1013 Valve Project, as described above, was \$192,324 as shown in Table 5. This estimate was prepared in May 2014 using contractor quotes and historical material costs from similar SoCalGas and SDG&E projects. The PSEP valve estimating tool was not used because the project team believed the contractor quotes and historic data provided sufficient information to provide a preliminary estimate for this small-scale valve project.

Pipeline Safety Enhancement Plan Workpaper Supporting Chapter V
BREA STATION - 1013 VALVE PROJECT

Table 5: Brea Station – 1013 Valve Project Phase 2 WOA Estimate

Cost Category	Phase 2 WOA
Company Labor Costs	\$ 25,000
Contract Costs	\$ 40,000
Materials Costs	\$ 85,000
Other Direct Costs	-
Total Direct Costs	\$ 150,000
Total Indirect Costs	\$ 42,324
Total Loaded Costs	\$ 192,324

Pipeline Safety Enhancement Plan Workpaper Supporting Chapter V
BREA STATION - 1013 VALVE PROJECT

Stage 4 – Detailed Engineering Design and Procurement

During Stage 4, SoCalGas and SDG&E developed and completed detailed engineering design work, selected a construction contractor and prepared for project construction.

Detailed Planning and Design

During Stage 4, the initial design for the Brea Station - 1013 Valve Project was updated to include the removal and replacement of the existing battery backup and automatic transfer switch within the existing instrumentation building. This change in design would enable the system to support both the new SCADA equipment and the existing SCADA equipment, rather than maintain two battery backup systems. This scope change occurred at the end of Stage 4, after the contractor proposal was received.

Construction Contractor Selection

The Brea Station - 1013 Valve Project went to construction before implementation of the Alliance Contractor program within PSEP. The electrical construction contractor was single-sourced based on experience with other PSEP projects and was contracted on a time-and-material, not-to-exceed basis. Because the valve had been replaced as part of the Line 1013 Replacement Project, a mechanical construction contractor was not needed.

The electrical contractor's bid was \$ [REDACTED], which is \$ [REDACTED] more than the construction contractor direct estimate of \$ [REDACTED] that was used to develop the Phase 2 WOA.

Pipeline Safety Enhancement Plan Workpaper Supporting Chapter V
BREA STATION - 1013 VALVE PROJECT

Stage 5 – Construction

Schedule

Construction Start Date: 10/01/2014

Construction Finish Date: 12/05/2014

NOP Date: 12/15/2014

Field Conditions

Conditions were encountered in the field that were not anticipated during design and planning that had to be addressed or mitigated. These conditions impacted the project scope and schedule. Listed below is summary of the key field changes broken down by type of change for this project:

Equipment Conditions:

- Once the construction team was on-site and preparing to install the new equipment, design improvements were determined to be necessary:
 - The new line break cabinet was modified to accept 3/8-inch fittings. The previous cabinet had a different diameter tubing (1/4-inch), which was not consistent with PSEP design standards.
 - The new SCADA cabinet wiring arrangement was modified to accommodate the battery backup system and the existing SCADA system. Due to the modification, new as-built drawings required preparation as well.

Coordination with Line 1013 Replacement Project:

- As noted earlier, this project was completed in coordination with the PSEP Line 1013 pipeline replacement project. The Line 1013 pipeline replacement project required the removal of an existing ultrasonic flow meter. An electrical contractor was required to reinstall the ultrasonic flow meter. To reduce overall PSEP costs by avoiding

Pipeline Safety Enhancement Plan Workpaper Supporting Chapter V
BREA STATION - 1013 VALVE PROJECT

mobilization/demobilization costs, the reinstallation of the meter was added to the scope of work for the Brea Station - 1013 Valve Project. The electrical contractor was also needed to install the cathodic protection and associated conduit and cable for the pipeline project. As such, this scope was also borne by the valve project to reduce overall PSEP costs.

Pipeline Safety Enhancement Plan Workpaper Supporting Chapter V
BREA STATION - 1013 VALVE PROJECT

Stages 6 and 7 – Commissioning and Closeout

Commissioning activities included site restoration, final inspections, and placement of the valve back into service. During this stage, SoCalGas and SDG&E successfully performed site acceptance testing and conducted point-to-point verification with SoCalGas Gas Control for the valve that had been automated. SoCalGas Field Operations personnel were trained on the use of new equipment. Close out activities included development of final drawings, the reconciliation package and updates to company systems to reflect the changes made to the system.

Table 6: Brea Station – 1013 Valve Project Phase 2 WOA Estimate and Actual Costs

COST SUMMARY				
	PHASE 2 WOA	CAPITAL (actuals)	DELTA over/(under)	
COMPANY LABOR	\$ 25,000	\$ 56,161	\$ 31,161	
CONTRACT COSTS	\$ 40,000	\$ 62,579	\$ 22,579	
MATERIALS	\$ 85,000	\$ 83,799	\$ (1,201)	
OTHER DIRECTS		\$ 37,190	\$ 37,190	
INDIRECTS	\$ 42,324	\$ 55,298	\$ 12,974	
TOTAL LOADED	\$ 192,324	\$ 295,027	\$ 102,703	

Table 6 compares the Phase 2 WOA estimate and the March 2016 loaded actual costs. The WOA estimate was calculated in Stage 3 using contractor quotes and historical material costs from similar SoCalGas and SDG&E projects.

The above variance is attributable to scope changes and unanticipated conditions that occurred after the Phase 2 WOA estimate (including: SCADA cabinet wiring and line break cabinet modifications) and estimating assumptions (resulting in underestimation of inspection and project support costs). These increased costs were reasonably incurred to complete the valve enhancement, but were not accounted for in the Stage 3 estimate.

Pipeline Safety Enhancement Plan Workpaper Supporting Chapter V
BREA STATION - 1013 VALVE PROJECT

Conclusion

SoCalGas and SDG&E enhanced the safety of their natural gas system by prudently executing the Brea Station-1013 Valve Project. Through this valve enhancement project, SoCalGas and SDG&E successfully upgraded one valve. The project incurred a total loaded project cost of \$295,027.

SoCalGas and SDG&E executed this project prudently through the coordination between this project and Line 1013 replacement project which maximized efficiency by managing and combining the contracted activities, avoiding the cost of multiple mobilizations and demobilizations of the mechanical and electrical contracted activity.

SoCalGas and SDG&E's total loaded project cost of \$295,027 is reasonable and should be approved. SoCalGas and SDG&E engaged in prudent cost avoidance efforts (coordinating work to realize efficiencies); engaged in reasonable efforts to promote competitive and market-based rates for contractor services and materials (see Chapter II (Phillips) (approximately 98% of PSEP agreements with contractors and suppliers were either competitively bid or through agreements entered into using market-based rates based on a recent competitive sourcing event)); and used a reasonable amount of company and contractor resources given the work scope changes (modification of the new line break cabinet and the new SCADA cabinet wiring arrangement).

End of Brea Station-1013 Valve Project Workpaper

Pipeline Safety Enhancement Plan Workpaper Supporting Chapter V
CHINO STATION VALVE PROJECT

Summary

Table 1: Summary of Chino Station Valve Project

Project Name	Chino Station Valve Project
WOA Number	91024
WOA Date	September 26, 2013
City	Chino Hills
Construction Start	December 23, 2013
NOP Date	September 10, 2014
Total Loaded Capital Costs	\$1,237,040
Total Loaded O&M Costs	\$ 0
Total Loaded Project Costs	\$1,237,040

Description

Through the Chino Station Valve Project, SoCalGas and SDG&E enhanced its natural gas transmission system by upgrading five valves, as shown in Table 2 and Figure 1. These valve enhancements are summarized as follows:

- Mainline Valve 4000-101.67-0 along Line 4000 was upgraded to include a standard PSEP technology suite, enabling both ASV and RCV functionality.
- Mainline Valve 4002-100.37-0 along Line 4002 was upgraded to include a standard PSEP technology suite, enabling both ASV and RCV functionality.
- Mainline Valve 2001-191.19-0 along Line 2001 was upgraded to include a standard PSEP technology suite, enabling both ASV and RCV functionality.
- Crossover Valve 2001-191.19-3 was upgraded with an actuator and remote control capability.
- Crossover Valve 2001-191.19-4 was upgraded with controls and power added to the existing actuator to enable remote control capability.

Pipeline Safety Enhancement Plan Workpaper Supporting Chapter V
CHINO STATION VALVE PROJECT

Examples of cost avoidance actions included:

- SoCalGas and SDG&E descope one of the original three valves that had been identified for replacement outside of Chino Station after determining that the same functionality could be achieved by retrofitting three other valves within Chino Station at less cost.
- The Chino Station Valve Project was one of nine projects that were combined into a comprehensive bid package for a mechanical and electrical construction contractor in order to capture efficiencies because the contractors were able to perform work simultaneously at the various sites and could manage work load between projects.
- Strength testing for small diameter pipe for the Chino Station Valve Project was combined with pipe strength testing activities for the Haskell, Moreno Small and Prado Station Valve Projects for efficiency purposes.

Construction began in December 2013 and was completed in April 2014. The Chino Station Valve Project incurred a total loaded project cost of \$1,237,040.

Table 2: Chino Station Valve Project Final Scope

Line	Valve ID	Valve Type	Installation Type	Function	Valve Size (inches)
4000	4000-101.67-0	Ball	CP	ASV/RCV	■
4002	4002-100.37-0	Ball	CP	ASV/RCV	■
2001	2001-191.19-0	Ball	CP	ASV/RCV	■
2001	2001-191.19-3	Ball	CP	RCV	■
2001	2001-191.19-4	Ball	CP	RCV	■

Pipeline Safety Enhancement Plan Workpaper Supporting Chapter V
CHINO STATION VALVE PROJECT

Figure 1: Satellite Image of Chino Station Valve Project



Pipeline Safety Enhancement Plan Workpaper Supporting Chapter V
CHINO STATION VALVE PROJECT

Stages 1 and 2 – Project Initiation

Table 3: 2011 PSEP Filing

2011 PSEP Filing						
Line	Mile	Valve #	Valve ID	Valve Size (inches)	Installation Type	Function
4000	101.67	0	4000-101.67-0	█	Ball	ASV
4000	101.67	3	4000-101.67-3*	█	N/A	RCV
4002	100.37	0	4002-100.37-0	█	Ball	ASV
2001	193.31	0	2001-193.91-0**	█	Ball	ASV

* 4000-101.67-3 was determined to already have RCV technology. Thus, it was removed from scope and not included further into Stages 1 & 2.

In the workpapers supporting the 2011 PSEP filing,¹ SoCalGas and SDG&E identified mainline valves 4000-101.67-0, 4000-101.67-3, 4002-100.37-0, and 2001-193.31-0 as a PSEP valve retrofit project. These mainline valves are located at the Chino Station in the city of Chino Hills and provide isolation of transmission pipeline segments in the event of an emergency.

¹ See December 2, 2011, Amended Pipeline Safety Enhancement Plan (PSEP) of SoCalGas and SDG&E.

Pipeline Safety Enhancement Plan Workpaper Supporting Chapter V
CHINO STATION VALVE PROJECT

Table 4: Chino Station Valve Project Stage 1 and 2 Scope

Stage 1 and 2 Scope						
Line	Mile	Valve #	Valve ID	Valve Size (inches)	Valve Type	Function
4000	101.67	0	4000-101.67-0	■	Ball	ASV/RCV
4002	100.37	0	4002-100.37-0	■	Ball	ASV/RCV
2001	191.19	0	2001-191.19-0**	■	Ball	ASV/RCV
2001	191.19	3	2001-191.19-3**	■	Ball	RCV
2001	191.19	4	2001-191.19-4**	■	Ball	RCV

**As further discussed below, Valve 2001-193-.91-0 from the PSEP filing was descoped, while Valves 2001-191.19-0, 2001-191.19-3 and 2001-191.19-4 were retrofitted.

During Stages 1 and 2, SoCalGas and SDG&E completed scope validation, detailed scope development and initial project coordination tasks to prepare for engineering, design, and construction of the Chino Station Valve Project.

The scope validation review of documentation related to the Chino Station Valve Project and site visits indicated that:

- Mainline valves 4000-101.67-0 and 4002-100.37-0, located within Chino Station, were identified in SoCalGas and SDG&E’s PSEP 2011 work papers, along with mainline valve 2001-193.31 (located outside the Chino Station), as a PSEP valve enhancement project.
- Mainline valve 4000-101.67-0 had an existing actuator, but was not equipped with ASV equipment.
- Mainline Valve 4002-100.37-0 had an existing actuator, but was not equipped with ASV equipment.
- Mainline valve 2001-193-31 (located outside the Chino Station), was manually operated. Upgrades to automate and enhance this valve would require additional expenses for the actuator and related vault installation due to the need to acquire land, utilities, and permits.

Pipeline Safety Enhancement Plan Workpaper Supporting Chapter V

CHINO STATION VALVE PROJECT

- Mainline valve 2001-191.19-0, which was located within Chino Station and provides isolation of transmission pipeline segments in the event of an emergency, had an existing actuator, but was not equipped with ASV equipment.
- Mainline valve 2001-191.19-0 had two accompanying crossover valves on the bridle assembly: 2001-191.19-3 (downstream) and 2001-191.19-4 (upstream).
- Crossover valve 2001-191.19-3, which normally operates in the open position to allow flow between Lines 2001, 4000, and 4002, was manually operated and was normally in the open position.
- Crossover valve 2001-191.19-4, which normally operates in the open position to allow flow between Lines 2001, 4000, and 4002, was equipped with an actuator and was normally in the open position.

SoCalGas and SDG&E conducted an in-depth site evaluation, including a field visit and further review of existing drawings. Additionally, through engineering analysis SoCalGas and SDG&E determined long lead items; communications and power needs; and made the following project scope modifications:

- Because mainline valve 2001-193-31 was not located within Chino Station and would likely result in significant costs to automate, it was descoped from the project in favor of mainline valve 2001-191.19-0. Mainline valve 2001-191.19-0 was added to the scope due to the fact it had an existing actuator and was located within Chino Station.
- Crossover valves 2001-191.19-3 and 2001-191.19-4, which allow flows between Lines 2001, 4000, and 4002, were added to the project scope for backflow prevention and remote control capability.

Pipeline Safety Enhancement Plan Workpaper Supporting Chapter V
CHINO STATION VALVE PROJECT

Stage 3 – Initial Planning and Design

During Stage 3, SoCalGas and SDG&E developed a Phase 2 WOA estimate, completed preliminary design drawings and further refined the scope. Preliminary drawings were also used to initiate procurement of long lead materials.

Planning and Design Activities

The design for Chino Station Valve Project was planned as follows:

Mainline Valve 4000-101.67-0

- Install new line break control panel equipped with standardized PSEP ASV technology.
- Install all conduit and cable from line break panel to new SCADAPack panel inside existing shelter.
- Install associated tubing, conduit, cable, utility power, and data communications.

Mainline Valve 4002-100.37-0

- Install new line break control panel equipped with standardized PSEP ASV technology.
- Install all conduit and cable from line break panel to new SCADAPack panel inside existing shelter.
- Install associated tubing, conduit, cable, utility power, and data communications.

Mainline Valve 2001-191.19-0

- Install new line break control panel equipped with standardized PSEP ASV technology.
- Install all conduit and cable from line break panel to new SCADAPack panel inside existing shelter.
- Install associated tubing, conduit, cable, utility power, and data communications.

Pipeline Safety Enhancement Plan Workpaper Supporting Chapter V

CHINO STATION VALVE PROJECT

Crossover Valve 2001-191.19-3

- Install pneumatic actuator and instrumentation.
- Install associated tubing, conduit, and cable.

Crossover Valve 2001-191.19-4

- Install controls and power, along with instrumentation.
- Install associated tubing, conduit, and cable.

Cost Avoidance

- A comprehensive bid package was created for nine projects which included the Chino Station Valve Project. They were combined into one comprehensive bid package for a mechanical and electrical contractor in order to capture efficiencies because the contractors would be able to perform work simultaneously at the various sites and could manage work load between projects more effectively.
- It was determined that strength testing for small diameter pipe for the Chino Station Valve Project could be combined with pipe strength testing activities for the Haskell, Moreno Small and Prado station valve projects for efficiency purposes.

Estimate of Costs

The Phase 2 WOA estimate for the total loaded cost to complete the scope of work for the Chino Station Valve Project as described above was \$995,207, as shown in Table 5. This estimate was prepared in September 2013 using version Stage 3 SCG Valve Estimate Template Rev Beta estimating tool and is based on preliminary design work.

Pipeline Safety Enhancement Plan Workpaper Supporting Chapter V
CHINO STATION VALVE PROJECT

Table 5: Chino Station Valve Project Phase 2 WOA Estimate

Cost Category	Phase 2 WOA
Company Labor Costs	\$106,334
Contract Costs	\$270,148
Material Costs	\$167,170
Other Direct Costs	\$262,319
Total Direct Costs	\$805,971
Total Indirect Costs	\$189,236
Total Loaded Costs	\$995,207

Pipeline Safety Enhancement Plan Workpaper Supporting Chapter V
CHINO STATION VALVE PROJECT

Stage 4 – Detailed Engineering Design and Procurement

During Stage 4, SoCalGas and SDG&E developed and completed detailed engineering design work, selected a construction contractor and prepared for project construction.

Detailed Planning and Design

There were no scope changes from Stage 3 to Stage 4.

Constructon Contractor Selection

Both a mechanical contractor and an electrical contractor are needed to complete construction of valve enhancement projects. In order to achieve cost and schedule efficiencies, SoCalGas and SDG&E identified nine valve projects that could be combined into two comprehensive bid packages, one for mechanical contractor services and one for electrical contractor services. The nine sites that were combined in this fashion were the Arrow & Haven project; and the Bain, Chino, Haskell, Moreno Large, Moreno Small, Prado, Santa Fe Springs, and Whitewater stations.

The construction contractors' bid was \$ [REDACTED], which is \$ [REDACTED] less than the Stage 3 Construction Contractor Direct Estimate of \$ [REDACTED] that was used to develop the Phase 2 WOA.

Pipeline Safety Enhancement Plan Workpaper Supporting Chapter V
CHINO STATION VALVE PROJECT

Stage 5 – Construction

Schedule

Construction Start Date: 12/23/2013

Construction Finish Date: 04/18/2014

NOP Date: 09/10/2014

Construction associated with the Chino Station Valve Project required two months longer than estimated due to construction crews encountering hardpan and rocky soil conditions in the vicinity of the lines, requiring time consuming manual excavation of the area. In addition, the limited resource availability to re-wire the existing SCADA panel with a new panel contributed to delays in construction.

Field Conditions

Conditions were encountered in the field that were not anticipated during design and planning that had to be addressed or mitigated. Listed below is a summary of the key field changes broken down by type of change for this project:

Equipment Conditions: Once the construction team was on-site and preparing to install the new equipment, design improvements were determined to be necessary:

- Installation of an additional tap to provide power gas to the actuator.
- Installation of an additional pressure transmitter to monitor pressure on the closed side of the actuator. This was a design change made by SoCalGas Gas Engineering during construction.
- Rewiring a portion of the SCADAPack panel to enhance communications.

Pipeline Safety Enhancement Plan Workpaper Supporting Chapter V
CHINO STATION VALVE PROJECT

Stages 6 and 7 – Commissioning and Closeout

Commissioning activities included site restoration, final inspections, and placement of the valves back into service. During this stage, SoCalGas and SDG&E successfully performed site acceptance testing and conducted point-to-point verification with SoCalGas Gas Control for each valve that had been automated. SoCalGas Field Operations personnel were trained on the use of new equipment. Close out activities included development of final drawings, the reconciliation package and updates to company systems to reflect the changes made to the system.

Cost Variance

Table 6: Chino Station Valve Project Phase 2 WOA Estimate and Actual Costs

COST SUMMARY				
	PHASE 2 WOA	CAPITAL (actuals)	DELTA over/(under)	
COMPANY LABOR	\$ 106,334	\$ 175,972	\$ 69,638	
CONTRACT COSTS	\$ 270,148	\$ 258,907	\$ (11,241)	
MATERIALS	\$ 167,170	\$ 148,057	\$ (19,113)	
OTHER DIRECTS	\$ 262,319	\$ 413,886	\$ 151,567	
INDIRECTS	\$ 189,236	\$ 240,218	\$ 50,982	
TOTAL LOADED	\$ 995,207	\$ 1,237,040	\$ 241,833	

Table 6 compares the Phase 2 WOA estimate and the March 2016 loaded actual costs. The loaded actual costs exceeded the Phase 2 WOA estimate by \$241,833.

The above variance is attributable to scope changes and unanticipated conditions that occurred after the Phase 2 WOA estimate (including: the rewiring a portion of the SCADAPack and additional field design changes) and an early cost estimating tool and process that was based on preliminary project designs (resulting in underestimation of environmental and project support). These increased costs were reasonably incurred to complete the project, but were not accounted for in the Stage 3 estimate.

Pipeline Safety Enhancement Plan Workpaper Supporting Chapter V
CHINO STATION VALVE PROJECT

Conclusion

SoCalGas and SDG&E enhanced the safety of their natural gas system by prudently executing the Chino Station Valve Project. Through this replacement project, SoCalGas and SDG&E successfully upgraded five valves. The project incurred a total loaded project cost of \$1,237,040.

SoCalGas and SDG&E executed this project prudently by coordinating and bundling nine valve projects into a comprehensive bid package in order to capture efficiencies and responded to unanticipated field changes including unanticipated site conditions, necessary field adjustments, and design changes.

SoCalGas and SDG&E's total loaded project cost of \$1,237,040 is reasonable and should be approved. SoCalGas and SDG&E engaged in prudent cost avoidance efforts (coordinating valve projects to realize efficiencies); engaged in reasonable efforts to promote competitive and market-based rates for contractor services and materials (see Chapter II (Phillips) (approximately 98% of PSEP agreements with contractors and suppliers were either competitively bid or through agreements entered into using market-based rates based on a recent competitive sourcing event)); and used a reasonable amount of company and contractor resources given the conditions and work scope changes experienced during construction.

End of Chino Station Valve Workpaper

Pipeline Safety Enhancement Plan Workpaper Supporting Chapter V
HASKELL STATION VALVE PROJECT

Summary

Table 1: Summary of Haskell Station Valve Project

Project Name	Haskell Station Valve Project
WOA Number	91026
WOA Date	September 26, 2013
City	Encino
Construction Start	January 27, 2014
NOP Date	November 14, 2014
Total Loaded Capital Costs	\$805,126
Total Loaded O&M Costs	\$ 0
Total Loaded Project Costs	\$805,126

Description

Through the Haskell Station Project, SoCalGas and SDG&E enhanced its high pressure transmission pipeline system by upgrading two valves, as shown in Table 2 and Figure 1. These valve enhancements are summarized as follows:

- Crossover Valve 120-103.49-2 was upgraded to include remote control capability, providing isolation between Line 120 and Line 121.
- Crossover Valve 3001-1.02-0 was upgraded by adding an actuator and remote control capability, providing isolation between Lines 3001 and 404.

Examples of cost avoidance actions included:

- SoCalGas and SDG&E descoped the original three valves that were identified for replacement after determining that the same functionality could be achieved by retrofitting two other valves at less cost.
- The Haskell Station Valve Project was one of nine projects that were combined into a comprehensive bid package for a mechanical and electrical engineering contractor in

Pipeline Safety Enhancement Plan Workpaper Supporting Chapter V
HASKELL STATION VALVE PROJECT

- order to capture efficiencies because the contractors were able to perform work simultaneously at the various sites and could manage work load between projects.
- Strength testing for small diameter pipe for the Haskell Station Valve Project was combined with pipe strength testing activities for the Chino, Moreno Small and Prado station valve projects for efficiency purposes.

Construction began in January 2014 and was completed in September 2014, which included schedule delays due to environmental abatement activities. The Haskell Station Valve Project incurred a total loaded project cost of \$805,126.

Table 2: Haskell Station Valve Project Final Scope

Line	Valve ID	Valve Type	Installation Type	Function	Valve Size (inches)
120	120-103.49-2	Ball	C/P	RCV	12
3001	3001-1.02-0	Ball	A/AG	RCV	24

Pipeline Safety Enhancement Plan Workpaper Supporting Chapter V
HASKELL STATION VALVE PROJECT

Figure 1: Satellite Image of Haskell Valve Station Project



Pipeline Safety Enhancement Plan Workpaper Supporting Chapter V
HASKELL STATION VALVE PROJECT

Stages 1 and 2 – Project Initiation, Analysis, and Findings

Table 3: 2011 PSEP Filing

2011 PSEP Filing						
Line	Mile	Valve #	Valve ID	Valve Size (inches)	Installation Type	Function
120	103.48	1	120-103.48-1*	■	NV/NP	RCV
404	55.42	0	404-55.42-0*	■	NV/NP	RCV
3001	1.01	0	3001-1.01-0*	■	AVT	RCV

In workpapers supporting the 2011 PSEP filing,¹ SoCalGas and SDG&E identified mainline valves 120-103.48-1, 404-55.42-0, and 3001-1.01-0 as a PSEP valve retrofit project. These mainline valves are located at Haskell Station in the community of Encino within the City of Los Angeles and provide isolation of pipeline segments in the event of an emergency. These three valves were grouped into one project bundle to optimize planning and construction efforts.

Table 4: Haskell Station Valve Project Stage 1 and 2 Scope

Stage 1 and 2 Scope						
Line	Mile	Valve #	Valve ID	Valve Size (inches)	Valve Type	Function
120	103.49	2	120-103.49-2*	■	Ball	RCV
3001	1.02	0	3001-1.02-0*	■	Ball	RCV

*As further discussed below, Valves 120-103.48-1, 404-55.42-0 and 3001-1.01-0 were descoped. Valves 120-103.49-2 and 3001-1.02-0 were added to the scope.

¹ See December 2, 2012, Pipeline Safety Enhancement Plan (PSEP) of SoCalGas and SDG&E.

Pipeline Safety Enhancement Plan Workpaper Supporting Chapter V

HASKELL STATION VALVE PROJECT

During Stages 1 and 2, SoCalGas and SDG&E completed scope validation, detailed scope development, and initial project coordination tasks to prepare for engineering, design, and construction of the Haskell Station Valve Project.

The scope validation review of documentation related to the Haskell Station Valve Project and site visits indicated that:

- Mainline valve 120-103.48-1 was manually operated and was normally in the closed position. However, flow from Line 120 to Line 121 still occurred through valves 120-103.49-1 and 120-103.49-2, which operated as service and monitor pressure control valves, respectively.
- Mainline valve 404-55.42-0 was operating as the monitor pressure control valve and is pneumatically operated. Directly upstream of valve 404-55.42-0 was valve 404-54.42-11. Valve 404-54.42-11 was already equipped with remote control capability.
- Line 3001 begins near the community of Encino and ends near the community of Sherman Oaks within the city of Los Angeles, a distance of approximately 5 miles. Mainline valves already exist on either end of the pipeline and isolation can be provided by upgrading those valves with ASV/RCV technology.
- Crossover valve 3001-1.02-0 allows flow from Line 404 to Line 3001. This valve was manually operated and was normally in the open position.

SoCalGas and SDG&E conducted an in-depth site evaluation, including a field visit and further review of existing drawings. Additionally, through engineering analysis, SoCalGas and SDG&E determined long lead items; communications and power needs; and made the following project scope modifications:

- Mainline valve 120-103.48-1 was descoped because it could not provide isolation. Crossover valve 120-103.49-2 was added to scope to provide isolation.
- Mainline valve 404-55.42-0 was descoped because the valve directly upstream (valve 404.54.42-11) was already equipped with remote control capability.

Pipeline Safety Enhancement Plan Workpaper Supporting Chapter V
HASKELL STATION VALVE PROJECT

- Mainline valve 3001-1.01-0 was descoped because it was determined that the close proximity of the mainline valves on each end of L3001 provided adequate isolation, and therefore ASV/RCV of valve 3001-1.01-0 was no longer required.
- Crossover valve 3001-1.02-0 was added to scope as a backflow prevention measure and upgraded with remote control capability.

Pipeline Safety Enhancement Plan Workpaper Supporting Chapter V
HASKELL STATION VALVE PROJECT

Stage 3 – Initial Planning and Design

During Stage 3, SoCalGas and SDG&E developed a Phase 2 WOA estimate, completed preliminary design drawings and further refined the scope. Preliminary drawings were also used to initiate procurement of long lead materials. The design for the Haskell Station Valve Project was planned as follows:

Crossover Valve 3001-1.02-0

- Install pneumatic actuator and instrumentation.
- Install associated tubing, conduit, and cable.

Crossover Valve 120-103.49-2

- Install new remote control system panel.
- Install associated tubing and conduit going from the DNGP panel to pressure transmitter and existing SCADAPack panel in control house.
- Retrofit existing SCADAPack Programmable Logic Controller, which provides real-time valve status and control and operating pressures to the SoCalGas Gas Control Center.

Cost Avoidance

The Haskell Station Valve Project was one of nine projects that were combined into a comprehensive bid package for a mechanical and electrical engineering contractor in order to capture efficiencies because the contractors were able to perform work simultaneously at the various sites and could manage work load between projects.

Strength testing for small diameter pipe for the Haskell Station Valve Project was combined with pipe strength testing activities for the Chino, Moreno Small and Prado station valve projects for efficiency purposes.

Pipeline Safety Enhancement Plan Workpaper Supporting Chapter V
HASKELL STATION VALVE PROJECT

Estimate of Costs

The Phase 2 WOA estimate of the total loaded cost to complete the scope of work for the Haskell Station Valve Project as described above was \$528,462 as shown in Table 5. This estimate was prepared in September 2013 using the Stage 3 SCG Valve Estimate Template Rev Beta estimating tool and was based on preliminary design work.

Table 5: Haskell Station Valve Project Phase 2 WOA Estimate

Cost Category	Phase 2 WOA
Company Labor Costs	\$58,392
Contract Costs	\$61,907
Material Costs	\$66,433
Other Direct Costs	\$241,310
Total Direct Costs	\$428,042
Total Indirect Costs	\$100,420
Total Loaded Costs	\$528,462

Pipeline Safety Enhancement Plan Workpaper Supporting Chapter V
HASKELL STATION VALVE PROJECT

Stage 4 – Detailed Engineering Design and Procurement

During Stage 4, SoCalGas and SDG&E developed and completed detailed engineering design work, selected a construction contractor, and prepared for project construction.

Detailed Planning and Design

There were no scope changes from Stage 3 to Stage 4.

Construction Contractor Selection

Both a mechanical contractor and an electrical contractor are needed to complete construction of valve enhancement projects. In order to achieve cost and schedule efficiencies, SoCalGas and SDG&E identified nine valve projects that could be combined into two comprehensive bid packages, one for mechanical contractor services and one for electrical contractor services. The nine sites that were combined in this fashion were the Arrow & Haven project; and the Bain, Chino, Haskell, Moreno Large, Moreno Small, Prado, Santa Fe Springs, and Whitewater stations.

The construction contractors' bid was \$ [REDACTED], which is \$ [REDACTED] more than the Stage 3 construction contractor direct estimate of \$ [REDACTED] that was used to develop the Phase 2 WOA.

Pipeline Safety Enhancement Plan Workpaper Supporting Chapter V
HASKELL STATION VALVE PROJECT

Stage 5 – Construction

Schedule

Construction Start Date: 01/27/2014

Construction Finish Date: 09/19/2014

NOP Date: 11/14/2014

Construction duration was planned to be 25 days, but instead spanned 30 days within a 34-week period. Once construction was initially mobilized, it was discovered that environmental work was required on the control room because the building was pre-1950 construction and had asbestos and lead-containing material, which delayed the construction schedule by several months. During this time, construction crews were reassigned to other valve projects that required support.

In addition, operational delays occurred due to resource availability and coordination associated with upgrading the existing control system.

Field Conditions

Conditions were encountered in the field that were not anticipated during design and planning that had to be addressed or mitigated. Listed below is a summary of the key field changes broken down by type of change for this project.

Equipment Conditions: Once the construction team was on-site and preparing to install the new equipment, design improvements were determined to be necessary.

- Additional wiring, hardware and software modifications made to the existing SCADAPack panel as a result of recommendations from programmer during construction.

Pipeline Safety Enhancement Plan Workpaper Supporting Chapter V
HASKELL STATION VALVE PROJECT

- Traffic bollards were determined to be necessary to protect the actuator.
- Additional soil excavation was required due to soil conditions.

Environmental:

- Environmental abatement work was determined to be necessary during construction due to discovery of asbestos and lead-containing materials in the control room.

Pipeline Safety Enhancement Plan Workpaper Supporting Chapter V
HASKELL STATION VALVE PROJECT

Stages 6 and 7 – Commissioning and Closeout

Commissioning activities included site restoration, final inspections, and placement of the valves back into service. During this stage, SoCalGas and SDG&E successfully performed site acceptance testing and conducted point-to-point verification with SoCalGas Gas Control for each valve that had been automated. SoCalGas Field Operations personnel were trained on the use of new equipment. Close out activities included development of final drawings, the reconciliation package and updates to company systems to reflect the changes made to the system.

Cost Variance

Table 6: Haskell Station Valve Project Phase 2 WOA Estimate and Actual Costs

COST SUMMARY				
	PHASE 2 WOA	CAPITAL (actuals)	DELTA over/(under)	
COMPANY LABOR	\$ 58,392	\$ 61,262	\$	2,870
CONTRACT COSTS	\$ 61,907	\$ 219,206	\$	157,299
MATERIALS	\$ 66,433	\$ 46,012	\$	(20,421)
OTHER DIRECTS	\$ 241,310	\$ 371,171	\$	129,861
INDIRECTS	\$ 100,420	\$ 107,476	\$	7,056
TOTAL LOADED	\$ 528,462	\$ 805,126	\$	276,664

Table 6 compares the Phase 2 WOA estimate and the March 2016 loaded actual costs. The loaded actual costs exceeded the Phase 2 WOA estimate by \$276,664.

The above variance is attributable to scope changes and unanticipated conditions that occurred after the Phase 2 WOA estimate (including: field design changes to add additional wiring, modifications to the existing SCADAPack panel, and environmental abatement to address asbestos) and an early cost estimating tool and process that was based on preliminary project designs (resulting in underestimating of construction contractor costs, inspection costs, survey costs, and other project support costs). These increased costs were reasonably incurred to complete the valve enhancement work, but were not accounted for in the Stage 3 estimate.

Pipeline Safety Enhancement Plan Workpaper Supporting Chapter V
HASKELL STATION VALVE PROJECT

Conclusion

SoCalGas and SDG&E enhanced the safety of their natural gas system by prudently executing the Haskell Station Valve Project. Through this valve enhancement project, SoCalGas and SDG&E successfully upgraded two valves. The project incurred a total loaded project cost of \$805,126.

SoCalGas and SDG&E executed this project prudently by coordinating and bundling nine valve projects into a comprehensive bid package in order to capture efficiencies and responded to unanticipated field changes including unanticipated site conditions, necessary field adjustments, and design changes.

SoCalGas and SDG&E's total loaded project cost of \$805,126 is reasonable and should be approved. SoCalGas and SDG&E engaged in prudent cost avoidance efforts (engineering and designing the project to use two valves instead of three; combining valve projects into a comprehensive bid package in order to capture efficiencies; and coordinating work for efficiency purposes); engaged in reasonable efforts to promote competitive and market-based rates for contractor services and materials (see Chapter II (Phillips) (approximately 98% of PSEP agreements with contractors and suppliers were either competitively bid or through agreements entered into using market-based rates based on a recent competitive sourcing event)); and used a reasonable amount of company and contractor resources given the conditions and work scope changes experienced during construction.

End of Haskell Station Valve Project Workpaper

Pipeline Safety Enhancement Plan Workpaper Supporting Chapter V
MORENO LARGE STATION VALVE PROJECT

Summary

Table 1: Summary of Moreno Large Station Valve Project

Project Name	Moreno Large Station Valve Project
WOA Number	91027
WOA Date	September 10, 2013
City	Moreno Valley
Construction Start	January 27, 2014
NOP Date	December 9, 2014
Total Loaded Capital Costs	\$ 616,166
Total Loaded O&M Costs	\$ 0
Total Loaded Project Costs	\$ 616,166

Description

Through the Moreno Large Station Valve Project, SoCalGas and SDG&E enhanced its system by installing one flow meter and a new vault, as shown in Table 2 and Figures 1 and 2.

Examples of cost avoidance actions included:

- Through engineering analysis, the original scope was reduced from three valves to one flow meter by utilizing the existing valves in the system.
- By upgrading the existing panel rather than replacing it, cost savings were achieved.
- The Moreno Large Station Valve Project was one of nine projects that were combined into a comprehensive bid package for a mechanical and electrical contractor in order to capture efficiencies because the contractors were able to perform work simultaneously at the various sites and could manage work load between projects.
- Two-inch nipple testing for the Moreno Large Station Valve Project was combined with testing for the Moreno Small Station Valve Project for efficiency purposes.

Pipeline Safety Enhancement Plan Workpaper Supporting Chapter V
MORENO LARGE STATION VALVE PROJECT

Construction began in January 2014 and was completed in June 2014. The Moreno Large Station Valve Project incurred a total loaded project cost of \$616,166.

Table 2: Moreno Large Station Valve Project Final Scope

Line	Valve ID	Valve Type	Installation Type	Function	Valve Size (inches)
5000	N/A	N/A	Flow Meter	Flow Meter	■

Pipeline Safety Enhancement Plan Workpaper Supporting Chapter V
MORENO LARGE STATION VALVE PROJECT

Figure 1: Satellite Image of Moreno Large Station Valve Project



Figure 2: Image of Installation of Concrete Vault



Pipeline Safety Enhancement Plan Workpaper Supporting Chapter V
MORENO LARGE STATION VALVE PROJECT

Stages 1 and 2 – Project Initiation

Table 3: 2011 PSEP Filing

2011 PSEP Filing					
Line	Mile	Valve ID	Valve Size (inches)	Installation Type	Function
1027	0.00	1027-0.00-0	■	NV/NP	ASV/RCV
6900	0.00	6900-0.00-0	■	A/AG	ASV/RCV
5000	157.82	5000-157.82-0	■	C/P	ASV/RCV

In workpapers supporting the 2011 PSEP filing,¹ SoCalGas and SDG&E identified mainline valves 1027-0.00-0, 6900-0.00-0, and 5000-157.82-0 as a PSEP valve enhancement project. These valves are located at the Moreno Large Station in the city of Moreno Valley and provide isolation of pipeline segments in the event of an emergency.

Table 4: Moreno Large Station Valve Project Stage 1 and 2 Scope

Stage 1 and 2 Scope						
Line	Mile	Valve Number	Valve ID	Valve Size (inches)	Installation Type	Function
5000	NA	NA	NA	■	Flow Meter	Flow Meter

During Stages 1 and 2, SoCalGas and SDG&E completed scope validation, detailed scope development, and initial project coordination tasks to prepare for engineering, design, and construction of the Moreno Large Station Valve Project.

¹ See December 2, 2011 Amended Pipeline Safety Enhancement Plan (PSEP) of SoCalGas and SDG&E.

Pipeline Safety Enhancement Plan Workpaper Supporting Chapter V

MORENO LARGE STATION VALVE PROJECT

The scope validation review of documentation related to the Moreno Large Station Valve Project and site visits indicated that:

- Mainline valves 1027-0.00-0, 6900-0.00-0, and 5000-157.82-0, which were identified in the PSEP 2011 filing, were determined to not require upgrades after confirming existing remote control capability on adjacent downstream valves 2000-155.06-7 and 2000-155.06-8.
- Valves 2000-155.06-7 and 2000-155.06-8 which were not identified in the 2011 PSEP filing, but required for backflow prevention between pipelines, were then considered for the project scope in order to isolate Line 2000 from Lines 2005 and 5000.
- In addition, one flow meter was determined to be necessary for the project in order to provide real-time volumetric flow data to SoCalGas Gas Control for leak detection purposes, and to determine flow direction between pipelines in case of rupture.

The scope validation review of documentation related to the Moreno Large Station Valve Project and site visits indicated that:

- Valve 2000-155.06-7 is normally in the closed position.
- Valve 2000-155.06-8 is already equipped with remote control capability

SoCalGas and SDG&E conducted an in-depth site evaluation, including a field visit, and further reviewed the existing drawings. Through engineering analysis, SoCalGas and SDG&E determined long lead items and communication and power needs, and further refined the scope as follows:

- Because valve 2000-155.06-7 is normally in the closed position, preventing flow from Line 2000 to Line 2005 and creating the required isolation, this valve was de-scoped from the project.

Pipeline Safety Enhancement Plan Workpaper Supporting Chapter V
MORENO LARGE STATION VALVE PROJECT

- Because valve 2000-155.06-8 was already equipped with remote control capability, the valve was de-scoped from the project.

Pipeline Safety Enhancement Plan Workpaper Supporting Chapter V MORENO LARGE STATION VALVE PROJECT

Stage 3 – Initial Planning and Design

During Stage 3, SoCalGas and SDG&E developed a Phase 2 WOA estimate, completed preliminary design drawings and further refined the scope. Preliminary drawings were also used to initiate procurement of long lead materials. The design for Moreno Large Station Valve Project was planned as follows:

Ultrasonic Flow Meter on Line 5000

- Install new Ultrasonic Clamp-On Flow Meter.
- Install new concrete vault to house the flow meter (see Figure 2 for a photo of the vault installation).
- Install associated tubing, sensors, and conduit.

Cost Avoidance

- The Moreno Large Station Valve Project was one of nine projects that were combined into a comprehensive bid package for a mechanical and electrical contractor in order to capture efficiencies because the contractors were able to perform work simultaneously at the various sites and could manage work load between projects.
- Two-inch nipple testing for the Moreno Large Station Valve Project was combined with testing for the Moreno Small Station Valve Project for efficiency purposes.

Estimate of Costs

The Phase 2 WOA estimate for the total loaded cost to complete the scope of work for the Moreno Large Station Valve Project as described above was \$393,505, as shown in Table 5. This estimate was prepared in September 2013 using the Stage 3 SCG Valve Estimate Template Rev Beta estimating tool and is based on preliminary design work.

Pipeline Safety Enhancement Plan Workpaper Supporting Chapter V
MORENO LARGE STATION VALVE PROJECT

Table 5: Moreno Large Station Valve Project Phase 2 WOA Estimate

Cost Category	Phase 2 WOA
Company Labor Costs	\$ 47,082
Contract Costs	\$ 49,004
Material Costs	\$ 40,934
Other Direct Costs	\$ 177,915
Total Direct Costs	\$ 314,935
Total Indirect Costs	\$ 78,570
Total Loaded Costs	\$ 393,505

Pipeline Safety Enhancement Plan Workpaper Supporting Chapter V
MORENO LARGE STATION VALVE PROJECT

Stage 4 – Detailed Engineering Design and Procurement

During Stage 4, SoCalGas and SDG&E developed and completed detailed engineering design work, selected a construction contractor and prepared for project construction.

Detailed Planning and Design

There were no scope changes from Stage 3 to Stage 4.

Construction Contractor Selection

Both a mechanical contractor and an electrical contractor are needed to complete construction of valve enhancement projects. In order to achieve cost and schedule efficiencies, SoCalGas and SDG&E identified nine valve projects that could be combined into two comprehensive bid packages, one for mechanical contractor services and one for electrical contractor services. The nine sites that were combined in this fashion were the Arrow & Haven project; and the Bain, Chino, Haskell, Moreno Large, Moreno Small, Prado, Santa Fe Springs and Whitewater stations.

The construction contractor's bid was \$ [REDACTED] which is \$ [REDACTED] more than the Stage 3 construction contractor direct estimate of \$ [REDACTED] that was used to develop the Phase 2 WOA.

Pipeline Safety Enhancement Plan Workpaper Supporting Chapter V
MORENO LARGE STATION VALVE PROJECT

Stage 5 – Construction

Schedule

Construction Start Date: 01/27/2014

Construction Finish Date: 06/10/2014

NOP Date: 12/09/2014

The construction of the Moreno Large Project was delayed by eight weeks due to time associated with securing the replacement thermowell tap as explained below, as well as due to resource availability associated with upgrading the existing control system.

Field Conditions

Conditions were encountered in the field that were not anticipated during design and planning that had to be addressed or mitigated. Listed below is a summary of the key field changes broken down by type of change for this project.

Constructability Issues:

- The tap used for the thermowell was changed from [REDACTED] to [REDACTED] so that a specialized tapping machine did not have to be located.
- A crane was required for offloading flow meter.

Safety:

- A vault vent was added to aid in the ventilation of the vault.

Pipeline Safety Enhancement Plan Workpaper Supporting Chapter V
MORENO LARGE STATION VALVE PROJECT

Design Improvement:

- Wiring revisions associated with the upgrade of the existing panel were made to the existing control system.

Pipeline Safety Enhancement Plan Workpaper Supporting Chapter V
MORENO LARGE STATION VALVE PROJECT

Stages 6 and 7 – Commissioning and Closeout

Commissioning activities included site restoration, final inspections, and placement of the valves back into service. During this stage, SoCalGas and SDG&E successfully performed site acceptance testing and conducted point-to-point verification with SoCalGas Gas Control for each valve that had been automated. SoCalGas Field Operations personnel were trained on the use of new equipment. Close out activities included development of final drawings, the reconciliation package and updates to company systems to reflect the changes made to the system.

Cost Variance

Table 6: Moreno Large Station Valve Project Phase 2 WOA Estimate and Actual Costs

COST SUMMARY				
	PHASE 2 WOA	CAPITAL (actuals)	DELTA over/(under)	
COMPANY LABOR	\$ 47,082	\$ 73,200	\$	26,118
CONTRACT COSTS	\$ 49,004	\$ 137,112	\$	88,108
MATERIALS	\$ 40,934	\$ 36,616	\$	(4,318)
OTHER DIRECTS	\$ 177,915	\$ 257,129	\$	79,214
INDIRECTS	\$ 78,570	\$ 112,109	\$	33,539
TOTAL LOADED	\$ 393,505	\$ 616,166	\$	222,661

Table 6 compares the Phase 2 WOA estimate and the March 2016 loaded actual costs. The loaded actual costs exceeded the Phase 2 WOA estimate by \$222,661.

Pipeline Safety Enhancement Plan Workpaper Supporting Chapter V
MORENO LARGE STATION VALVE PROJECT

The above variance is attributable to scope changes and unanticipated conditions that occurred after the Phase 2 WOA estimate (including: redesign of the flow meter thermowell; installation of a vault vent; and revising the control system wiring) and an early cost estimating tool and process that was based on preliminary project designs (resulting in underestimation of labor, inspection, engineering and other project support costs). These increased costs were reasonably incurred to complete the valve enhancement, but were not accounted for in the Stage 3 estimate.

Pipeline Safety Enhancement Plan Workpaper Supporting Chapter V
MORENO LARGE STATION VALVE PROJECT

Conclusion

SoCalGas and SDG&E enhanced the safety of their natural gas system by prudently executing the Moreno Large Station Valve Project. Through this project, SoCalGas and SDG&E successfully installed a flow meter. The project incurred a total loaded project cost of \$616,166.

SoCalGas and SDG&E executed this project prudently: engaging in prudent cost avoidance efforts; designing the project to use, where practicable, existing equipment; coordinating work and projects to capture efficiencies; and responding prudently to scope changes and field conditions.

SoCalGas and SDG&E's total loaded project cost of \$616,166 is reasonable and should be approved. SoCalGas and SDG&E engaged in prudent cost avoidance efforts (designing the project to use existing valves and thereby reducing scope from three valves to a flow meter, upgrading instead of replacing an existing valve panel, bundling valve projects to capture efficiencies, and coordinating and combining related work for efficiency purposes); engaged in reasonable efforts to promote competitive and market-based rates for contractor services and materials (see Chapter II (Phillips) (approximately 98% of PSEP agreements with contractors and suppliers were either competitively bid or through agreements entered into using market-based rates based on a recent competitive sourcing event)); and used a reasonable amount of company and contractor resources given the work scope changes (redesign of the flow meter thermowell; installation of a vault vent; and revising the control system wiring).

End of Moreno Large Station Valve Project Workpaper

Pipeline Safety Enhancement Plan Workpaper Supporting Chapter V
MORENO SMALL STATION VALVE PROJECT

Summary

Table 1: Summary of Moreno Small Station Valve Project

Project Name	Moreno Small Station Valve Project
WOA Number	91022
WOA Date	September 10, 2013
City	Moreno Valley
Construction Start	January 20, 2014
NOP Date	December 9, 2014
Total Loaded Capital Costs	\$861,101
Total Loaded O&M Costs	\$ 0
Total Loaded Project Costs	\$861,101

Description

Through the Moreno Small Station Valve Project, SoCalGas and SDG&E enhanced its gas transmission system by upgrading a valve and installing a flow meter, as shown in Table 1 and Figure 1. These two enhancements are summarized as follows:

- Bridle Crossover Valve 2001-155.95-3 along Line 2001 was upgraded to include a PSEP standard technology suite, enabling RCV functionality.
- A bi-directional flow meter was installed inside a new vault along Line 2005.

Examples of cost avoidance actions included:

- By upgrading the existing control panel rather than replacing it, cost savings were achieved.
- The Moreno Station Small Valve Project was one of nine projects that were combined into a comprehensive bid package for a mechanical and electrical contractor in order to capture efficiencies because the contractors were able to perform work simultaneously at the various sites and could manage work load between projects.

Pipeline Safety Enhancement Plan Workpaper Supporting Chapter V
MORENO SMALL STATION VALVE PROJECT

- Strength testing for small diameter pipe for the Moreno Small Station Valve Project was combined with pipe strength testing activities for three other projects that reduced costs.
- Two-inch nipple testing for the Moreno Small Station Valve Project was combined with testing at another valve project for efficiency purposes.

Construction began in January 2014 and was completed in June 2014. The Moreno Small Station Valve Project incurred a total loaded project cost of \$861,101.

Table 2: Moreno Small Station Valve Project Final Scope

Line	Valve ID	Valve Type	Installation Type	Function	Valve Size (inches)
2001	2001-155.95-3	Ball	A / AG	RCV	■
2005	N/A	N/A	Flow Meter	Flow Meter	■

Pipeline Safety Enhancement Plan Workpaper Supporting Chapter V
MORENO SMALL STATION VALVE PROJECT

Figure 1: Satellite Image of Moreno Small Station Valve Project



Pipeline Safety Enhancement Plan Workpaper Supporting Chapter V
MORENO SMALL STATION VALVE PROJECT

Stages 1 and 2 – Project Initiation

SoCalGas and SDG&E have identified bridle valve 2001-155.95-3 at the Moreno Small Station in Moreno Valley as a PSEP valve retrofit project. While this bridle valve was not specifically called out in 2011 PSEP filing,¹ retrofitting the valve is consistent with the objectives outlined in the filing regarding the need to ensure for backflow prevention.

In addition, as part of this project, SoCalGas and SDG&E have also identified the need for a new flow meter consistent with the objectives in the 2011 PSEP filing with respect to installing such meters to support verification of a rupture event by operating personnel, its location and its impacts on various sections of the transmission line. Additional details are provided below.

Table 3: Moreno Small Station Valve Project Stage 1 and 2 Scope

Stage 1 and 2 Scope						
Line	Mile	Valve #	Valve ID	Valve Size (inches)	Installation Type	Function
2001	155.95	3	2001-155.95-3	■	A/AG	RCV
2005	0	NA	NA	■	NA	Flow Meter

During Stages 1 and 2, SoCalGas and SDG&E completed scope validation, detailed scope development and initial project coordination tasks to prepare for engineering, design, and construction of the Moreno Small Station Valve Project.

The scope validation review of documentation related to the Moreno Small Station Valve Project and site visits indicated that:

¹ See December 2, 2011, Amended Pipeline Safety Enhancement Plan (PSEP) of SoCalGas and SDG&E.

Pipeline Safety Enhancement Plan Workpaper Supporting Chapter V
MORENO SMALL STATION VALVE PROJECT

- Bridle crossover valve 2001-155.95-3 is normally open and was manually operated. Upgrading this valve with remote control capability would provide isolation between Line 2000 and Line 2001 in the event of an emergency.
- In addition, installing a bi-directional ultrasonic flow meter on Line 2005 would provide real-time volumetric flow data to SoCalGas Gas Control for leak detection purposes and to determine flow direction between pipelines in the case of rupture.

SoCalGas and SDG&E conducted an in-depth site evaluation, including a field visit, and further reviewed the existing drawings. Through engineering analysis, SoCalGas and SDG&E determined long lead item and communication and power needs.

Pipeline Safety Enhancement Plan Workpaper Supporting Chapter V MORENO SMALL STATION VALVE PROJECT

Stage 3 – Initial Planning and Design

During Stage 3, SoCalGas and SDG&E developed a Phase 2 WOA estimate, completed preliminary design drawings and further refined the scope. Preliminary drawings were also used to initiate procurement of long lead materials. The design for Moreno Small Station Valve Project was planned as follows:

Bridle Crossover Valve 2001-155.95-3

- Install pneumatic actuator and instrumentation.
- Install associated tubing, conduit, and cable.

Ultrasonic Flow Meter on Line 2005

- Install new Ultrasonic Clamp-On Flow Meter.
- Install new concrete vault to house the flow meter.
- Install associated tubing, sensors, and conduit.
- Upgrade existing control system.

Cost Avoidance

- It was decided that the existing control panel could be upgraded rather than replacing it.
- The strength testing for the small diameter pipe that would be used within the Moreno Small Valve Project was to be combined with the pipe strength testing activities for the Chino, Haskell and Prado station valve projects.
- The two-inch nipple testing that would be completed for the Moreno Small Station Valve Project was to be combined with testing for the Moreno Large Station Valve Project.

Estimate of Total Costs

The Phase 2 WOA estimate of the total loaded cost for the to complete the scope of work for the Moreno Small Station Project as described above, was \$460,397, as shown in Table 4. This

Pipeline Safety Enhancement Plan Workpaper Supporting Chapter V
MORENO SMALL STATION VALVE PROJECT

estimate was prepared in September 2013 using the Stage 3 SCG Valve Estimate Template Rev Beta estimating tool and is based on preliminary design work.

Table 4: Moreno Small Station Valve Project Phase 2 WOA Estimate

Cost Category	Phase 2 WOA
Company Labor Costs	\$63,958
Contract Costs	\$47,068
Material Costs	\$57,750
Other Direct Costs	\$190,549
Total Direct Costs	\$359,325
Total Indirect Costs	\$101,072
Total Loaded Cost	\$460,397

Pipeline Safety Enhancement Plan Workpaper Supporting Chapter V
MORENO SMALL STATION VALVE PROJECT

Stage 4 – Detailed Engineering Design and Procurement

During Stage 4, SoCalGas and SDG&E developed and completed detailed engineering design work, selected a construction contractor, and prepared for project construction.

Detailed Planning and Design

There were no scope changes from Stage 3 to Stage 4.

Contractor Selection

Both a mechanical contractor and an electrical contractor are needed to complete construction of valve enhancement projects. In order to achieve cost and schedule efficiencies, SoCalGas and SDG&E identified nine valve projects that could be combined into two comprehensive bid packages, one for mechanical contractor services and one for electrical contractor services. The nine sites that were combined in this fashion were the Arrow & Haven project; and the Bain, Chino, Haskell, Moreno Large, Moreno Small, Prado, Santa Fe Springs, and Whitewater stations

The construction contractors' bid was \$ [REDACTED] which is \$ [REDACTED] more than the Stage 3 construction contractor direct estimate of \$ [REDACTED] that was used to develop the Phase 2 WOA.

Pipeline Safety Enhancement Plan Workpaper Supporting Chapter V
MORENO SMALL STATION VALVE PROJECT

Stage 5 – Construction

Schedule

Construction Start Date: 01/20/2014

Construction Finish Date: 06/10/2014

NOP Date: 12/09/2014

Construction for this project required coordination between PSEP and SoCalGas' Pipeline Integrity department due to the fact that the Pipeline Integrity department was involved with a separate project to install permanent launcher/receivers at the Moreno Small Station. This required the relocation of the existing electrical equipment shelter to another area within the station, which required a new electric service installation by the local electric utility company. This caused a delay of several months until the facility was ready for PSEP work.

In addition, operational delays occurred due to resource availability associated with upgrading the existing control system.

Field Conditions

Conditions were encountered in the field that were not anticipated during design and planning that had to be addressed or mitigated. Listed below is a summary of the key field changes broken down by type of change for this project:

Constructability Issues:

- The tap used for the flow meter's thermowell was changed from [REDACTED] to [REDACTED] so that a specialized tapping machine did not have to be located.

Pipeline Safety Enhancement Plan Workpaper Supporting Chapter V
MORENO SMALL STATION VALVE PROJECT

Safety:

- A vault vent was added to aid ventilation of the vault.

Design Improvement:

- Wiring revisions were made to the control system.

Pipeline Safety Enhancement Plan Workpaper Supporting Chapter V
MORENO SMALL STATION VALVE PROJECT

Stages 6 and 7 – Commissioning and Closeout

Commissioning activities included site restoration, final inspections, and placement of the valves back into service. During this stage, SoCalGas and SDG&E successfully performed site acceptance testing and conducted point-to-point verification with SoCalGas Gas Control for each valve that had been automated. SoCalGas Field Operations personnel were trained on the use of new equipment. Close out activities included development of final drawings, the reconciliation package and updates to company systems to reflect the changes made to the system.

Cost Variance

Table 5: Moreno Small Station Valve Project Phase 2 WOA Estimate and Actual Costs

COST SUMMARY				
	PHASE 2 WOA	CAPITAL (actuals)	DELTA over/(under)	
COMPANY LABOR	\$ 63,958	\$ 115,001	\$	51,043
CONTRACT COSTS	\$ 47,068	\$ 184,426	\$	137,358
MATERIALS	\$ 57,750	\$ 109,975	\$	52,225
OTHER DIRECTS	\$ 190,549	\$ 300,156	\$	109,607
INDIRECTS	\$ 101,072	\$ 151,543	\$	50,471
TOTAL LOADED	\$ 460,397	\$ 861,101	\$	400,704

Table 5 compares the Phase 2 WOA estimate and the March 2016 loaded actual costs. The loaded actual costs exceeded the Phase 2 WOA estimate by \$400,704.

The above variance is attributable to scope changes and unanticipated conditions that occurred after the Phase 2 WOA estimate (including: delays driven by other construction work being performed at Moreno Small Station, redesign of the flow meter thermowell; installation of a vault vent; and revising the control system wiring) and an early cost estimating tool and process that was based on preliminary project designs (resulting in underestimation of labor costs, inspection costs, construction contractor costs, material costs, survey costs, and other support costs).

Pipeline Safety Enhancement Plan Workpaper Supporting Chapter V
MORENO SMALL STATION VALVE PROJECT

These increased costs were reasonably incurred to complete the valve enhancement, but were not accounted for in the Stage 3 estimate.

Pipeline Safety Enhancement Plan Workpaper Supporting Chapter V
MORENO SMALL STATION VALVE PROJECT

Conclusion

SoCalGas and SDG&E enhanced the safety of their natural gas system by prudently executing the Moreno Small Valve Station Project. Through this valve enhancement project, SoCalGas and SDG&E successfully upgraded one valve and installed a flow meter. The project incurred a total loaded project cost of \$861,101.

SoCalGas and SDG&E executed this project prudently: engaging in prudent cost avoidance efforts; designing and executing the project to support the Valve Enhancement Plan isolation objective (see Chapter IV (Bermel)); and responding to unanticipated field changes including unanticipated site conditions, necessary field adjustments, and design changes.

SoCalGas and SDG&E's total loaded project cost of \$861,101 is reasonable and should be approved. SoCalGas and SDG&E engaged in prudent cost avoidance efforts (upgrading instead of replacing the existing control panel, bundling projects to capture efficiencies, and coordinating work and testing to realize efficiencies); engaged in reasonable efforts to promote competitive and market-based rates for contractor services and materials (see Chapter II (Phillips) (approximately 98% of PSEP agreements with contractors and suppliers were either competitively bid or through agreements entered into using market-based rates based on a recent competitive sourcing event)); and used a reasonable amount of company and contractor resources given the complex scope of work (requiring coordination with Pipeline Integrity construction at Moreno Small Station) and work scope changes (redesign of the flow meter thermowell; installation of a vault vent; and revising the control system wiring).

End of Moreno Small Valve Station Project Workpaper

Pipeline Safety Enhancement Plan Workpaper Supporting Chapter V
PIXLEY STATION VALVE PROJECT

Summary

Table 1: Summary of Pixley Station Project

Project Name	Pixley Station Valve Project
WOA Number	91044
WOA Date	June 4, 2014
City	Orange
Construction Start	November 3, 2014
NOP Date	May 13, 2015
Total Loaded Capital Costs	\$1,549,003
Total Loaded O&M Costs	\$ 0
Total Loaded Project Costs	\$1,549,003

Description

Through the Pixley Station Valve Project, SoCalGas and SDG&E enhanced its gas transmission system by upgrading three valves, as shown in Table 2 and Figure 1. These three valve enhancements are summarized as follows:

- Mainline Valve 1015-6.07-0 along Line 1015 was upgraded to include a standard PSEP technology suite enabling both ASV and RCV functionality of mainline valves.
- Bridle Tap Valve 1015-6.07-1 was upgraded with an actuator and remote control capability.
- Bridle Tap Valve 1015-6.07-2 was upgraded with an actuator and remote control capability.

Construction began in November 2014 and was completed in March 2015. The Pixley Station Valve Project incurred a total loaded project cost of \$1,549,003.

Pipeline Safety Enhancement Plan Workpaper Supporting Chapter V
PIXLEY STATION VALVE PROJECT

Table 2: Pixley Station Valve Project Final Scope

Line	Valve ID	Valve Type	Installation Type	Function	Valve Size (inches)
1015	1015-6.07-0	Ball	A/AG	ASV/RCV	■
1015	1015-6.07-1	Ball	A/AG	RCV	■
1015	1015-6.07-2	Ball	A/AG	RCV	■

Pipeline Safety Enhancement Plan Workpaper Supporting Chapter V
PIXLEY STATION VALVE PROJECT

Figure 1: Satellite Image of Pixley Station Valve Project



Pipeline Safety Enhancement Plan Workpaper Supporting Chapter V
PIXLEY STATION VALVE PROJECT

Stages 1 and 2 – Project Initiation

Table 3: 2011 PSEP Filing

2011 PSEP Filing					
Line	Mile	Valve ID	Valve Size (inches)	Installation Type	Function
1015	6.07	1015-6.07-0	■	NV/VT	ASV/RCV

In workpapers supporting the 2011 PSEP filing,¹ SoCalGas and SDG&E identified mainline valve 1015-6.07-0 as a PSEP valve enhancement project. This mainline valve is located at the Pixley Station in the city of Orange and provides isolation of transmission pipeline segments in the event of an emergency.

Table 4: Pixley Station Valve Project Stage 1 and 2 Scope

Stage 1 and 2 Scope							
Line	Mile	Valve #	Valve ID	Valve Size (inches)	Valve Type	Installation Type	Function
1015	6.07	0	1015-6.07-0	■	Ball	A/AG	ASV/RCV
1015	6.07	1	1015-6.07-1	■	Ball	A/AG	RCV
1015	6.07	2	1015-6.07-2	■	Ball	A/AG	RCV

During Stages 1 and 2, SoCalGas and SDG&E completed scope validation, detailed scope development, and initial project coordination tasks to prepare for engineering, design, and construction of the Pixley Station Valve Project.

The scope validation review of documentation related to the Pixley Station Valve Project and site visits indicated that:

¹See December 2, 2011, Pipeline Safety Enhancement Plan (PSEP) of SoCalGas and SDG&E.

Pipeline Safety Enhancement Plan Workpaper Supporting Chapter V
PIXLEY STATION VALVE PROJECT

- In 2011, Mainline Valve 1015-6.07-0 located at Pixley Station, was identified in SoCalGas and SDG&E's' PSEP workpapers as a PSEP valve enhancement project.
- Mainline Valve 1015-6.07-0 had been identified in the PSEP filing as being a [REDACTED] valve. However, the valve was determined to be a [REDACTED] valve.
- Mainline valve 1015-6.07-0 has two accompanying valves on the bridle assembly: 1015-6.07-1 (upstream) and 1015-6.07-2 (downstream).
- Pixley Station was retrofitted by SoCalGas Pipeline Integrity in 2012, at which time all three valves were replaced with ball valves in order to accommodate the use of in-line inspection technology.
- Mainline Valve 1015-6.07-0 was manually operated and was normally in the open position.
- Bridle Tap Valve 1015-6.07-1 was manually operated and was normally in the open position.
- Bridle Tap Valve 1015-6.07-2 was manually operated and was normally in the open position.

Based on the above findings, the scope was updated as shown above in Table 4.

Pipeline Safety Enhancement Plan Workpaper Supporting Chapter V
PIXLEY STATION VALVE PROJECT

Stage 3 – Initial Planning and Design

During Stage 3, SoCalGas and SDG&E developed a Phase 2 WOA estimate, completed preliminary design drawings and further refined the scope. Preliminary drawings were also used to initiate procurement of long lead materials.

Planning and Design Activity

The design for the Pixley Station Valve Project was planned as follows:

Mainline Valve 1015-6.07-0

- Install pneumatic actuator and instrumentation.
- Install new line break control panel equipped with standardized PSEP ASV technology.
- Install SCADAPack panel equipped with remote control technology.
- Install associated tubing, conduit, cable, utility power, and data communications.

Bridle Tap Valve 1015-6.07-1

- Install pneumatic actuator and instrumentation.
- Install standardized PSEP RCV technology.
- Install associated tubing, conduit, cable, utility power, and data communications.

Bridle Tap Valve 1015-6.07-2

- Install pneumatic actuator and instrumentation.
- Install standardized PSEP RCV technology.
- Install associated tubing, conduit, cable, utility power, and data communications.

Pipeline Safety Enhancement Plan Workpaper Supporting Chapter V
PIXLEY STATION VALVE PROJECT

Estimate of Costs

The preliminary estimate for the total loaded cost to complete the scope of work for the Pixley Station Valve Project, as described above, was \$1,025,154, as shown in Table 5. This estimate was prepared in June 2014 using Stage 3 SCG Valve Estimate Template Rev 0 estimating tool and is based on preliminary design work.

Table 5: Pixley Station Valve Project Phase 2 WOA Estimate

Cost Category	Phase 2 WOA
Company Labor Costs	\$81,462
Contract Costs	\$279,453
Material Costs	\$192,326
Other Direct Costs	\$308,631
Total Direct Costs	\$861,872
Total Indirect Costs	\$163,282
Total Loaded Costs	\$1,025,154

Pipeline Safety Enhancement Plan Workpaper Supporting Chapter V
PIXLEY STATION VALVE PROJECT

Stage 4 – Detailed Engineering Design and Procurement

During Stage 4, SoCalGas and SDG&E completed detailed engineering design work, contractor selection, and performed the following actions to prepare for project construction:

Detailed Planning and Design

No scope changes occurred from Stage 3 to Stage 4.

Construction Contractor Selection

The mechanical contract was awarded to the PSEP Performance Partner for this assigned geographical area. The electrical contract was awarded to the approved Alliance contractor for this project

The Performance Partner/Construction Contractors' TPE was \$ [REDACTED], which is \$ [REDACTED] more than the Stage 3 construction contractor direct estimate of \$ [REDACTED] that was used to develop the Phase 2 WOA.

Pipeline Safety Enhancement Plan Workpaper Supporting Chapter V
PIXLEY STATION VALVE PROJECT

Stage 5 – Construction

Schedule

Construction Start Date: 11/03/2014

Construction Finish Date: 03/20/2015

NOP Date: 05/13/2015

The construction schedule for the Pixley Station Valve Project required 16 weeks longer than planned due to additional material requirements based on field conditions and due to a design change to improve communications reliability.

Field Conditions

Conditions were encountered in the field that were not anticipated during design and planning that had to be addressed or mitigated. These conditions impacted project scope and schedule. Listed below is a summary of the key field changes broken down by type of change for this project:

Constructability issues:

- The existing mainline valve was not the manufacturer type expected, requiring construction of an adapter plate.
- Due to the unavailability of the expected radio communications system, the electrical contractor had to install power and work with AT&T to provide 4-wire communications to ensure that valve control could be provided via a telecommunications system.
- The standard design for line break panels changed after the panels were ordered. As such, the ½-inch tubing connectors required replacement with 3/8-inch connectors in the line break panel.

Pipeline Safety Enhancement Plan Workpaper Supporting Chapter V
PIXLEY STATION VALVE PROJECT

Materials:

- Delays in the delivery of actuators that led to a two-month delay for start of construction.

Pipeline Safety Enhancement Plan Workpaper Supporting Chapter V
PIXLEY STATION VALVE PROJECT

Stages 6 and 7 – Commissioning and Closeout

Commissioning activities included site restoration, final inspections, and placement of the valves back into service. During this stage, SoCalGas and SDG&E successfully performed site acceptance testing and conducted point-to-point verification with SoCalGas Gas Control for each valve that had been automated. SoCalGas Field Operations personnel were trained on the use of new equipment. Close out activities included development of final drawings, the reconciliation package and updates to company systems to reflect the changes made to the system.

Cost Variance

Table 6: Pixley Station Valve Project Phase 2 WOA Estimate versus Actual Costs

COST SUMMARY				
	PHASE 2 WOA	CAPITAL (actuals)	DELTA over/(under)	
COMPANY LABOR	\$ 81,462	\$ 158,539	\$	77,077
CONTRACT COSTS	\$ 279,453	\$ 543,247	\$	263,794
MATERIALS	\$ 192,326	\$ 125,929	\$	(66,397)
OTHER DIRECTS	\$ 308,631	\$ 500,846	\$	192,215
INDIRECTS	\$ 163,282	\$ 220,442	\$	57,160
TOTAL LOADED	\$ 1,025,154	\$ 1,549,003	\$	523,849

Table 6 compares the Phase 2 WOA estimate and the March 2016 loaded actual costs. The loaded actual costs exceeded the Phase 2 WOA estimate by \$523,849.

The above variance is attributable to scope changes and unanticipated conditions that occurred after the Phase 2 WOA estimate (see above) and an early version of the cost estimating tool and process that was based on preliminary design work.

Pipeline Safety Enhancement Plan Workpaper Supporting Chapter V
PIXLEY STATION VALVE PROJECT

Conclusion

SoCalGas and SDG&E enhanced the safety of their natural gas system by prudently executing the Pixley Station Valve Project. Through this valve enhancement project, SoCalGas and SDG&E successfully upgraded three valves. The project incurred a total loaded cost of \$1,549,003.

SoCalGas and SDG&E executed this project prudently and enhanced system safety, responded to numerous unanticipated field changes including construction of an adapter plate, unavailability of the expected radio communications system, need to redesign the line break panel, and actuator delivery delays.

SoCalGas and SDG&E's total loaded project cost of \$1,549,003 is reasonable and should be approved. SoCalGas and SDG&E engaged in reasonable efforts to promote competitive and market-based rates for contractor services and materials (see Chapter II (Phillips) (approximately 98% of PSEP agreements with contractors and suppliers were either competitively bid or through agreements entered into using market-based rates based on a recent competitive sourcing event)); and used a reasonable amount of company and contractor resources given the work scope changes (construction of an adapter plate for the mainline valve; coordination with AT&T to provide 4-wire communications for valve control when the anticipated radio communications system was not available; replacement of ½-inch tubing connectors with 3/8-inch connectors when the standard design for break panels changed after panels were ordered; and modifying the construction schedule due to delays in the delivery of actuators).

End of Pixley Station Valve Project Workpaper

Pipeline Safety Enhancement Plan Workpaper Supporting Chapter V
PRADO STATION VALVE PROJECT

Summary

Table 1: Summary of Prado Station Valve Project

Project Name	Prado Station Valve Project
WOA Number	91030
WOA Date	September 18, 2013
City	Yorba Linda
Construction Start	January 20, 2014
NOP Date	July 24, 2014
Total Loaded Capital Costs	\$1,411,385
Total Loaded O&M Costs	\$ 0
Total Loaded Project Costs	\$1,411,385

Description

Through the Prado Station Valve Project, SoCalGas and SDG&E enhanced its gas transmission system by upgrading five valves as shown in Table 2 and Figure 1. These five valve enhancements are summarized as follows:

- Mainline Valve 4002-106.02-0 along Line 4002 was upgraded with an actuator and a standard PSEP technology suite enabling both ASV and RCV functionality.
- Bridle Tap Valve 4002-106.02-3 was upgraded with an actuator and remote control capability.
- Bridle Tap Valve 4002-106.02-4 was upgraded with an actuator and remote control capability.
- Mainline Valve 4000-107.25-0, along Line 4000 was upgraded with an actuator and a standard PSEP technology suite enabling both ASV and RCV functionality.

Pipeline Safety Enhancement Plan Workpaper Supporting Chapter V
PRADO STATION VALVE PROJECT

- Mainline Valve 2000-193.18-0 along Line 2000 was upgraded to include a standard PSEP technology suite enabling both ASV and RCV functionality.

Example of cost avoidance actions included:

- The Prado Station Valve Project was one of nine projects that were combined into a comprehensive bid package for a mechanical and electrical contractor in order to capture efficiencies because the contractors were able to perform work simultaneously at the various sites and could manage work load between projects.
- Strength testing for small diameter pipe for the Prado Station Valve Project was combined with pipe strength testing activities for the Chino, Haskell and Moreno Small station valve projects for efficiency purposes.

Construction began in January 2014 and was completed in June 2014. The Prado Station Valve Project incurred a total loaded project cost of \$1,411,385.

Table 2: Prado Station Valve Project Final Scope

Line	Valve ID	Valve Type	Installation Type	Function	Valve Size (inches)
4002	4002-106.02-0	Ball	A/AG	ASV/RCV	■
4002	4002-106.02-3	Ball	A/AG	RCV	■
4002	4002-106.02-4	Ball	A/AG	RCV	■
4000	4000-107.25-0	Ball	A/AG	ASV/RCV	■
2000	2000-193.18-0	Ball	CP	ASV/RCV	■

Pipeline Safety Enhancement Plan Workpaper Supporting Chapter V
PRADO STATION VALVE PROJECT

Figure 1: Satellite Image of Prado Station Valve Project



Pipeline Safety Enhancement Plan Workpaper Supporting Chapter V
PRADO STATION VALVE PROJECT

Stages 1 and 2 – Project Initiation

Table 3: 2011 PSEP Filing

2011 PSEP Filing					
Line	Mile	Valve ID	Valve Size (inches)	Installation Type	Function
4002	106.02	4002-106.02-0	■	C/P	ASV/RCV
4000	107.25	4000-107.25-0	■	C/P	ASV/RCV
2000	193-18	2000-193.18-13	■	NV/NP	RCV

In workpapers supporting the 2011 PSEP filing,¹ SoCalGas and SDG&E identified mainline valves 4000-107.25-0 and 4002-106.02-0, along with crossover valve 2000-193.18-13, as a PSEP valve retrofit project. These valves are located at the Prado Station in the city of Yorba Linda and provide isolation of transmission pipeline segments in the event of an emergency.

Table 4: Prado Station Valve Project Stage 1 and 2 Scope

Stage 1 and 2 Scope						
Line	Mile	Valve #	Valve ID	Valve Size (inches)	Valve Type	Function
4002	106.02	0	4002-106.02-0	■	Ball	ASV/RCV
4002	106.02	3	4002-106.02-3	■	Ball	RCV
4002	106.02	4	4002-106.02-4	■	Ball	RCV
4000	107.25	0	4000-107.25-0	■	Ball	ASV/RCV
2000	193.18	0	2000-193.18-0	■	Ball	ASV/RSV

¹ See December 2, 2011, Amended Pipeline Safety Enhancement Plan (PSEP) of SoCalGas and SDG&E.

Pipeline Safety Enhancement Plan Workpaper Supporting Chapter V

PRADO STATION VALVE PROJECT

During Stages 1 and 2, SoCalGas and SDG&E completed scope validation, detailed scope development and initial project coordination tasks to prepare for engineering, design, and construction of the Prado Station Valve Project.

The scope validation review of documentation related to the Prado Station Valve Project and in-depth site evaluation indicated that:

- In 2011, mainline valves 4002-106-02-0 and 4000-107-25-0, and crossover valve 2000-193.18-13 were identified in SoCalGas and SDG&E's PSEP work papers as a PSEP valve enhancement project.
- Mainline valve 4002-106.02-0 was manually operated and normally in the open position.
- Mainline valve 4002-106.02-0 has two accompanying bridles on the upstream and downstream sides, 4002-106.02-3 and 4002-106.02-4. Both bridle crossover valves control flow around the mainline valve and between Line 2000, Line 4000, and Line 4002. These bridle crossover valves were added to the project.
- Bridle crossover valve 4002-106.02-3 was manually operated and normally in the open position.
- Bridle crossover valve 4002-106.02-4 was manually operated and normally in the open position.
- Mainline valve 4000-107.25-0 was manually operated and normally in the open position.
- Crossover valve 2000-193.18-13 was determined to be a service valve already equipped with remote control capability and was therefore de-scoped from the project.
- Mainline valve 2000-193.18-0 was added to the project. Mainline valve 2000-193.18-0 was manually operated and was normally in the open position.

SoCalGas and SDG&E further reviewed the existing drawings and using the engineering, determined long lead items and communication and power needs.

Pipeline Safety Enhancement Plan Workpaper Supporting Chapter V
PRADO STATION VALVE PROJECT

Stage 3 – Initial Planning and Design

During Stage 3, SoCalGas and SDG&E developed a Phase 2 WOA estimate, completed preliminary design drawings and further refined the scope. Preliminary drawings were also used to initiate procurement of long lead materials.

The design for Prado Station Valve Project was planned as follows:

Mainline Valve 4002-106.02-0

- Install pneumatic actuator and instrumentation.
- Install new line break control panel equipped with standardized PSEP ASV technology.
- Install associated tubing, conduit, cable, utility power, and data communications.

Bridle Crossover Valve 4002-106.02-3

- Install pneumatic actuator and instrumentation.
- Install associated tubing, conduit, and cable.

Bridle Crossover Valve 4002-106.02-4

- Install pneumatic actuator and instrumentation.
- Install associated tubing, conduit, and cable.

Mainline Valve 4000-107.25-0

- Install pneumatic actuator and instrumentation.
- Install new line break control panel equipped with standardized PSEP ASV technology.
- Install associated tubing, conduit, cable, utility power, and data communications.

Mainline Valve 2000-193.18-0

- Install new line break control panel equipped with standardized PSEP ASV technology.
- Install a SCADAPack panel equipped with remote control technology.

Pipeline Safety Enhancement Plan Workpaper Supporting Chapter V
PRADO STATION VALVE PROJECT

- Install associated tubing, conduit, cable, utility power, and data communications.

Cost Avoidance

- The Prado Station Valve Project was one of nine projects that were combined into a comprehensive bid package for a mechanical and electrical contractor in order to capture efficiencies because the contractors were able to perform work simultaneously at the various sites and could manage work load between projects.
- It was determined that the strength testing for most of the small diameter pipe for the Prado Station Valve Project could be combined with pipe strength testing activities that were occurring for the Chino, Haskell and Moreno Small Station Valve Projects to increase project efficiency.

Estimate of Costs

The estimate of the total loaded cost for the Prado Station Valve Project as described above was \$1,331,965, as shown in Table 5. This estimate was prepared in September 2013 using the Stage 3 SCG Valve Estimate Template Rev Beta estimating tool and is based on preliminary design work.

Table 5: Prado Station Valve Project Phase 2 WOA Estimate

Cost Category	Phase 2 WOA
Company Labor Costs	\$142,244
Contract Costs	\$219,365
Material Costs	\$400,750
Other Direct Costs	\$316,276
Total Direct Costs	\$1,078,635
Total Indirect Costs	\$253,330
Total Loaded Costs	\$1,331,965

Pipeline Safety Enhancement Plan Workpaper Supporting Chapter V
PRADO STATION VALVE PROJECT

Stage 4 – Detailed Engineering Design and Procurement

During Stage 4, SoCalGas and SDG&E developed and completed detailed engineering design work, selected a construction contractor, and prepared for project construction.

Detailed Planning and Design

There were no scope changes from Stage 3 to Stage 4.

Contractor Selection

Both a mechanical contractor and an electrical contractor are needed to complete construction of valve enhancement projects. In order to achieve cost and schedule efficiencies, SoCalGas and SDG&E identified nine valve projects that could be combined into two comprehensive bid packages, one for mechanical contractor services and one for electrical contractor services. The nine sites that were combined in this fashion were the Arrow & Haven project; and the Bain, Chino, Haskell, Moreno Large, Moreno Small, Prado, Santa Fe Springs, and Whitewater stations.

The construction contractor's bid was \$ [REDACTED] which is \$ [REDACTED] less than the Stage 3 construction contractor direct estimate of \$ [REDACTED] that was used to develop the Phase 2 WOA.

Pipeline Safety Enhancement Plan Workpaper Supporting Chapter V
PRADO STATION VALVE PROJECT

Stage 5 – Construction

Schedule

Construction Start Date: 01/20/2014

Construction Finish Date: 06/23/2014

NOP Date: 07/24/2014

Field Conditions

Conditions were encountered in the field that were not anticipated during design and planning that had to be addressed or mitigated. Listed below is a summary of the key field changes broken down by type of change for this project:

Equipment Conditions: Once the construction team was on-site and preparing to install the new equipment, design improvements were determined to be required:

- Additional pressure transmitters were installed due to system requirements.
- After construction had already started, additional taps were determined to be required for better accuracy of pressure sensing.
- The SCADA panel had to be field designed to another location to accommodate system needs.

Constructability Issues:

- One of the planned conduit routes intersected with the existing blowdown piping and had to be re-routed during construction.
- A crane was determined to be required for removal of existing valve actuator.
- Trench shoring was required after determining soil conditions.

Pipeline Safety Enhancement Plan Workpaper Supporting Chapter V
PRADO STATION VALVE PROJECT

- Existing shelter doors were modified for electrical area classification.
- Excavation was larger than anticipated by contractor and therefore additional zero-sack slurry was required for backfill.
- Bell hole excavation was required so that actuator contractor could have access to valve stem.

Pipeline Safety Enhancement Plan Workpaper Supporting Chapter V
PRADO STATION VALVE PROJECT

Stages 6 and 7 – Commissioning and Closeout

Commissioning activities included site restoration, final inspections, and placement of the valves back into service. During this stage, SoCalGas and SDG&E successfully performed site acceptance testing and conducted point-to-point verification with SoCalGas Gas Control for each valve that had been automated. SoCalGas Field Operations personnel were trained on the use of new equipment. Close out activities included development of final drawings, the reconciliation package and updates to company systems to reflect the changes made to the system.

Cost Variances

Table 6: Prado Station Valve Project Phase 2 WOA Estimate and Actual Costs

COST SUMMARY				
	PHASE 2 WOA	CAPITAL (actuals)	DELTA over/(under)	
COMPANY LABOR	\$ 142,244	\$ 142,486	\$	242
CONTRACT COSTS	\$ 219,365	\$ 339,418	\$	120,053
MATERIALS	\$ 400,750	\$ 290,691	\$	(110,059)
OTHER DIRECTS	\$ 316,276	\$ 434,422	\$	118,146
INDIRECTS	\$ 253,330	\$ 204,368	\$	(48,962)
TOTAL LOADED	\$ 1,331,965	\$ 1,411,385	\$	79,420

Table 6 compares the Phase 2 WOA estimate and the March 2016 loaded actual costs. The loaded actual costs exceeded the Phase 2 WOA estimate by \$79,420. Although there are no significant variances to note, as discussed above, numerous conditions were encountered in the field that were not anticipated during design and planning that had to be addressed or mitigated.

Pipeline Safety Enhancement Plan Workpaper Supporting Chapter V
PRADO STATION VALVE PROJECT

Conclusion

SoCalGas and SDG&E enhanced the safety of their natural gas system by prudently executing the Prado Station Valve Project. Through this enhancement project, SoCalGas and SDG&E successfully upgraded five valves. The project incurred a total loaded project cost of \$1,411,385.

SoCalGas and SDG&E executed this project prudently by coordinating and bundling nine valve projects into a comprehensive bid package in order to capture efficiencies and responded to unanticipated field changes including unanticipated site conditions, necessary field adjustments, and design changes.

SoCalGas and SDG&E's total loaded project cost of \$1,411,385 is reasonable and should be approved. SoCalGas and SDG&E engaged in prudent cost avoidance efforts (coordinating valve projects to realize efficiencies); engaged in reasonable efforts to promote competitive and market-based rates for contractor services and materials (see Chapter II (Phillips) (approximately 98% of PSEP agreements with contractors and suppliers were either competitively bid or through agreements entered into using market-based rates based on a recent competitive sourcing event)); and used a reasonable amount of company and contractor resources given the conditions and work scope changes experienced during construction.

End of Prado Station Valve Project Workpaper

Pipeline Safety Enhancement Plan Workpaper Supporting Chapter V
PUENTE STATION VALVE PROJECT

Summary

Table 1: Summary of Puente Station Valve Project

Project Name	Puente Station Valve Project
WOA Number	91047
WOA Date	January 30, 2014
City	La Puente
Construction Start	January 30, 2014
NOP Date	June 25, 2014
Total Loaded Capital Costs	\$19,486
Total Loaded O&M Costs	\$ 0
Total Loaded Project Costs	\$19,486

Description

Through the Puente Station Valve Project, SoCalGas and SDG&E enhanced its gas transmission system by installing two new check valves, as shown in Table 2 and Figure 1.

Example of cost avoidance actions included:

- Coordinated the planning and installation efforts of the two new check valves with a Gas Transmission Operations (GTO) project that was planned at the same site to reduce costs and promote construction efficiency. GTO personnel provided oversight for the installation of the check valves while conducting unrelated work at the station.

Construction began in January 2014 and was completed in June 2014. The Puente Station Valve Project incurred a total loaded project cost of \$19,486.

Pipeline Safety Enhancement Plan Workpaper Supporting Chapter V
PUENTE STATION VALVE PROJECT

Table 2: Puente Station Valve Project Final Scope

Line	Valve ID	Valve Type	Installation Type	Function	Valve Size (Inches)
2001	2001-207.69-17*	Check Valve	Backflow Prevention adding a Check Valve	N/A	■
2001	2001-207.69-18*	Check Valve	Backflow Prevention adding a Check Valve	N/A	■

Figure 1: Satellite Image of Puente Station Valve Project



Pipeline Safety Enhancement Plan Workpaper Supporting Chapter V

PUENTE STATION VALVE PROJECT

Stage 1 and 2 – Project Initiation

In workpapers supporting the 2011 PSEP filing,¹ SoCalGas and SDG&E proposed to retrofit 160 pipeline locations with backflow prevention equipment. Check valves and manual bypass are one means of preventing backflow, and is the preferred option for medium sized pipelines where regulator modification is impractical or there is no regulator station serving the connected pipeline. At the time of the filing, the specific sites that would require check valves had not been forecast because expanded engineering analysis of pipeline isolation was needed.

The Puente Station is located in the city of La Puente. Line 2001 feeds two distribution supply lines, SL 31-08 and SL 31-51, at this location. These two supply lines were determined to require two check valves after the tap valves to prevent backflow from those supply lines into the transmission lines.

Due to the size and scope of this project, the formal PSEP Seven Stage Review Process was not implemented. Rather, a similar decision methodology appropriate to this project and scope was employed. Because of an existing project already underway at Puente Station, the PSEP team coordinated with SoCalGas GTO to identify PSEP requirements, which included the need for the installation of the check valves to prevent backflow. PSEP communicated the requirements to GTO, which oversaw the installation.

¹ See December 2, 2011, Amended Pipeline Safety Enhancement Plan (PSEP) of SoCalGas and SDG&E.

Pipeline Safety Enhancement Plan Workpaper Supporting Chapter V
PUENTE STATION VALVE PROJECT

Table 3: Puente Station Valve Project Stage 1 and 2 Scope

Stage 1 and Stage 2 Scope						
Line	Mile	Valve #	Valve ID	Valve Size (inches)	Valve Type	Function
2001	207.69	17*	2001-207.69-17*	■	Check valve	N/A
2001	207.69	18*	2001-207.69-18*	■	Check valve	N/A

** Denotes valve numbers for tap valves directly upstream of the check valves. These check valves are part of the station assembly and are not assigned valve numbers.*

Pipeline Safety Enhancement Plan Workpaper Supporting Chapter V
PUENTE STATION VALVE PROJECT

Stage 3 – Initial Planning and Design

During Stage 3, GTO notified the PSEP team of capital improvement work underway at the Puente Station. The PSEP team reviewed the work being performed by GTO and confirmed that this site was one identified for backflow prevention and recommended that check valves be installed to meet PSEP objectives. Because the check valve installation required the unbolting and re-bolting of check valves from and to an existing above-ground assembly, the PSEP team coordinated with GTO to have them oversee the installation of the check valves while GTO conducted its unrelated work at the station.

Cost Avoidance

- By coordinating schedules for this work with GTO, construction efficiencies were achieved by having one contractor perform the work and one organization to provide oversight. GTO personnel provided oversight for the installation of the check valves while conducting unrelated work at the station.

Estimate of Costs

The PSEP team received contractor quotes for the check valves and estimated the labor associated with the installation. These quotes were used for the Phase 2 WOA. The PSEP estimating tool was not used to complete the estimate; rather a high-level estimate was provided based on material costs for this project and an assumption that minimal labor would be required.

Pipeline Safety Enhancement Plan Workpaper Supporting Chapter V
PUENTE STATION VALVE PROJECT

Table 4: Puente Station Valve Project Phase 2 WOA Estimate

Cost Category	Phase 2 WOA
Company Labor Costs	\$2,200
Contract Costs	\$2,400
Material Costs	\$6,658
Other Direct Costs	\$1,000
Total Direct Costs	\$12,258
Total Indirects Costs	\$3,549
Total Loaded Costs	\$15,807

Pipeline Safety Enhancement Plan Workpaper Supporting Chapter V
PUENTE STATION VALVE PROJECT

Stage 4 – Detailed Engineering Design and Procurement

PSEP was able to coordinate existing outreach, environmental, and permitting efforts associated with the ongoing construction project at this station with GTO.

Construction Contractor Selection

A single valve contractor was used for the check valve installation. Work was single-sourced because of the small scope of work. The PSEP team issued a purchase order for the valve contractor. GTO oversaw the contractor.

Pipeline Safety Enhancement Plan Workpaper Supporting Chapter V
PUENTE STATION VALVE PROJECT

Stage 5 – Construction

Schedule

Construction Start: 06/16/2014

Construction Finish: 06/25/2014

NOP: 06/25/2014

Field Conditions

The Installation of the two check valves took one day each. Due to resource availability the work was not able to be completed in consecutive days.

Pipeline Safety Enhancement Plan Workpaper Supporting Chapter V
PUENTE STATION VALVE PROJECT

Stages 6 and 7 – Commissioning and Closeout

Commissioning activities included site restoration, final inspections, and placement of the valves back into service. During this stage, SoCalGas and SDG&E successfully performed site acceptance testing and conducted point-to-point verification with SoCalGas Gas Control for each valve that had been automated. SoCalGas Field Operations personnel were trained on the use of new equipment. Close out activities included development of final drawings, the reconciliation package and updates to company systems to reflect the changes made to the system.

Cost Variance

Table 5: Puente Station Valve Project Phase 2 WOA Estimate and Actual Costs

COST SUMMARY				
	PHASE 2 WOA	CAPITAL (actuals)	DELTA over/(under)	
COMPANY LABOR	\$ 2,200	\$ 4,012	\$ 1,812	
CONTRACT COSTS	\$ 2,400	\$ -	\$ (2,400)	
MATERIALS	\$ 6,658	\$ 5,675	\$ (983)	
OTHER DIRECTS	\$ 1,000	\$ 6,211	\$ 5,211	
INDIRECTS	\$ 3,549	\$ 3,588	\$ 39	
TOTAL LOADED	\$ 15,807	\$ 19,486	\$ 3,679	

Table 5 compares the Phase 2 WOA and the March 2016 loaded actual costs. There are no significant variances to note.

Pipeline Safety Enhancement Plan Workpaper Supporting Chapter V
PUENTE STATION VALVE PROJECT

Conclusion

SoCalGas and SDG&E enhanced the safety of their natural gas system by prudently executing the Puente Station Valve Project. Through this valve enhancement project, SoCalGas and SDG&E successfully improved the backflow protection by installing two check valves. The project incurred a total loaded project cost of \$19,486.

End of Puente Station Valve Project Workpaper

Pipeline Safety Enhancement Plan Workpaper Supporting Chapter V
SANTA FE SPRINGS STATION VALVE PROJECT

Summary

Table 1: Summary of Santa Fe Springs Station Valve Project

Project Name	Santa Fe Springs Station Valve Project
WOA Number	91025
WOA Date	September 15, 2013
City	Santa Springs
Construction Start	March 18, 2014
NOP Date	June 3, 2014
Total Loaded Capital Costs	\$813,358
Total Loaded O&M Costs	\$ 0
Total Loaded Project Costs	\$813,358

Description

Through the Santa Fe Springs Station Valve Project, SoCalGas and SDG&E enhanced this gas transmission system by upgrading one valve and installing two check valves, as shown in Table 2 and Figure 1.

These system enhancements are summarized as follows:

- Mainline Valve 2000-212.69-0 along Line 2000 was upgraded with a new actuator and a standard PSEP technology suite, enabling both ASV and RCV functionality.
- Two new [REDACTED] check valves were installed on the bridle valve assembly of the mainline valve 2000-212.69-0 for backflow prevention.

Example of cost avoidance actions included:

- The Santa Fe Springs Station Valve Project was one of nine projects that were combined into a comprehensive bid package for a mechanical and electrical engineering contractor in order to capture efficiencies because the contractors were able to perform work simultaneously at the various sites and could manage work load between projects.

Pipeline Safety Enhancement Plan Workpaper Supporting Chapter V
SANTA FE SPRINGS STATION VALVE PROJECT

Construction began in March 2014 and was completed in June 2014. The Santa Fe Springs Station Valve Project incurred a total loaded project cost of \$813,358.

Table 2: Santa Fe Springs Station Valve Project Final Scope

Line	Valve ID	Valve Type	Installation Type	Function	Valve Size (inches)
2000	2000-212.69-0	Plug	A/AG	ASV/RCV	■
2000	2000-212.69-1*	Check	Check Valve	Backflow Prevention	■
2000	2000-212.69-2*	Check	Check Valve	Backflow Prevention	■

**Denotes valve numbers for bridle valves directly upstream of the check valves. These check valves are part of the assembly and were not assigned valve numbers.*

Figure 1: Satellite Image of Santa Fe Springs Station Valve Project



Pipeline Safety Enhancement Plan Workpaper Supporting Chapter V
SANTA FE SPRINGS STATION VALVE PROJECT

Stages 1 and 2 – Project Initiation

Table 3: 2011 PSEP Filing

2011 PSEP Filing					
Line	Mile	Valve ID	Valve Size (inches)	Installation Type	Function
2000	212.69	2000-212.69-0	■	NV/NP	ASV/RCV

In workpapers supporting the 2011 PSEP filing¹, SoCalGas and SDG&E identified mainline valve 2000-212.69-0 as a PSEP valve retrofit project.

This mainline valve is located at Santa Fe Springs Station in the city of Santa Fe Springs and provides isolation of transmission pipeline segments in the event of an emergency.

Table 4: Santa Fe Springs Station Valve Project Stage 1 and 2 Scope

Stage 1 and 2 Scope						
Line	Mile	Valve #	Valve ID	Valve Size (inches)	Installation Type	Function
2000	212.69	0	2000-212.69-0	■	A/AG	ASV/RCV
2000	212.69	1*	2000-212.69-1*	■	Check	Backflow Prevention
2000	212.69	2*	2000-212.69-2*	■	Check	Backflow Prevention

**Denotes valve numbers for bridle valves directly upstream of the check valves. These check valves are part of the assembly and were not assigned valve numbers.*

During Stage 1 and 2, SoCalGas and SDG&E completed scope validation, detailed scope development and initial project coordination tasks to prepare for engineering, design, and construction of the Santa Fe Springs Station Valve Project.

¹ See December 2, 2011, Amended Pipeline Safety Enhancement Plan (PSEP) of SoCalGas and SDG&E.

Pipeline Safety Enhancement Plan Workpaper Supporting Chapter V
SANTA FE SPRINGS STATION VALVE PROJECT

- The scope validation related to the Santa Fe Springs Station Valve Project and site visit indicated that:
- Mainline valve 2000-212.69-0 was a [REDACTED] valve.
- Mainline valve 2000-212.69-0 was manually operated with an actuator that is non-compatible with ASV technology. Upgrading the mainline valve with a new actuator and a standard PSEP technology suite would enable both ASV and RCV functionality of the mainline valve.
- Line 2000 feeds several distribution regulator stations at the Santa Fe Springs Station. A new check valve and a replacement check valve would add backflow prevention from the connected distribution systems to Line 2000.

Pipeline Safety Enhancement Plan Workpaper Supporting Chapter V
SANTA FE SPRINGS STATION VALVE PROJECT

Stage 3 – Initial Planning and Design

During Stage 3, SoCalGas and SDG&E developed a Phase 2 WOA estimate, completed preliminary design drawings and further refined the scope. Preliminary drawings were also used to initiate procurement of long lead materials.

Planning and Design Activity

Mainline Valve 2000-212.69-0

- Install new line break control panel equipped with standardized PSEP ASV technology.
- Install new SCADAPack panel equipped with remote control technology.
- Install new actuator.
- Install associated tubing, conduit, cable, utility power and data communications.

Check Valves

- Install two new check valves.

Cost Avoidance

- The Santa Fe Springs Valve Project was one of nine projects that were combined into a comprehensive bid package for a mechanical and electrical engineering contractor in order to capture efficiencies because the contractors were able to perform work simultaneously at the various sites and could manage work load between projects.

Estimate of Total Costs

The Phase 2 WOA estimate of the total loaded cost to complete the scope of work for the Santa Fe Springs Station Valve Project as described above was \$610,465, as shown in Table 5. This estimate was prepared in September 2013 using the Stage 3 SCG Valve Estimate Template Rev Beta estimating tool, and is based on preliminary design work.

Pipeline Safety Enhancement Plan Workpaper Supporting Chapter V
SANTA FE SPRINGS STATION VALVE PROJECT

Table 5: Santa Fe Springs Station Valve Project Phase 2 WOA Estimate

Cost Category	Phase 2 WOA
Company Labor Costs	\$70,255
Contract Costs	\$66,137
Material Costs	\$142,604
Other Direct Costs	\$211,008
Total Direct Costs	\$490,005
Total Indirect Costs	\$120,460
Total Loaded Costs	\$610,465

Pipeline Safety Enhancement Plan Workpaper Supporting Chapter V
SANTA FE SPRINGS STATION VALVE PROJECT

Stage 4 – Detailed Engineering Design and Procurement

During Stage 4, SoCalGas and SDG&E developed and completed detailed engineering design work, selected a construction contractor and prepared for project construction.

Detailed Planning and Design

There were no scope changes from Stage 3 to Stage 4.

Construction Contractor Selection

Both a mechanical contractor and an electrical contractor are needed to complete construction of valve enhancement projects. In order to achieve cost and schedule efficiencies, SoCalGas and SDG&E identified nine valve projects that could be combined into two comprehensive bid packages, one for mechanical contractor services and one for electrical contractor services. The nine sites that were combined in this fashion were the Arrow & Haven project; and the Bain, Chino, Haskell, Moreno Large, Moreno Small, Prado, Santa Fe Springs and Whitewater stations.

The construction contractor's bid was \$ [REDACTED] which is \$ [REDACTED] more than the Stage 3 construction contractor direct estimate of \$ [REDACTED] that was used to develop the Phase 2 WOA.

Pipeline Safety Enhancement Plan Workpaper Supporting Chapter V
SANTA FE SPRINGS STATION VALVE PROJECT

Stage 5 – Construction

Schedule

Construction Start: 03/18/2014

Construction Finish: 06/03/2014

NOP Date: 06/03/2014

Construction associated with the Santa Fe Springs Station Valve Project required more time than estimated due to abatement of lead paint on the existing pipe and asbestos in the gasket. Resource availability associated with standby and material acquisition also contributed to delays.

Field Conditions

Conditions were encountered in the field that were not anticipated during design and planning that had to be addressed or mitigated. Listed below is a summary of the key field changes broken down by type of change for this project.

Constructability Issues:

- Additional pipe fabrication was required to match existing pipe class because during construction it was discovered that all of the existing flanges were not the same class.

Environmental:

- Environmental abatement was needed because the existing bolts and flanges were coated with lead paint and the existing gaskets contained asbestos, both of which required environmental abatement services.

Pipeline Safety Enhancement Plan Workpaper Supporting Chapter V
SANTA FE SPRINGS STATION VALVE PROJECT

Safety:

- Platform redesign and modifications were required to enable maintenance personnel to safely reach new instrumentation.

Resource Availability:

- Certain work, including tie-in activities as well as the function of providing access to the station itself was delayed due to resource availability.

Engineering Changes:

- Additional conduit was run to the SCADA panel due to revision to control design.

Materials:

- Fabricated panels arrived from the panel shop (non-compliant - missing parts) which required going back to the vendor, obtaining the missing parts and then installing them in the field.

Pipeline Safety Enhancement Plan Workpaper Supporting Chapter V
SANTA FE SPRINGS STATION VALVE PROJECT

Stages 6 and 7 – Commissioning and Closeout

Commissioning activities included site restoration, final inspections, and placement of the valves back into service. During this stage, SoCalGas and SDG&E successfully performed site acceptance testing and conducted point-to-point verification with SoCalGas Gas Control for each valve that had been automated. SoCalGas Field Operations personnel were trained on the use of new equipment. Close out activities included development of final drawings, the reconciliation package and updates to company systems to reflect the changes made to the system.

Cost Variance

Table 6: Santa Fe Springs Station Valve Project Phase 2 WOA Estimate and Actual Costs

COST SUMMARY				
	PHASE 2 WOA	CAPITAL (actuals)	DELTA over/(under)	
COMPANY LABOR	\$ 70,255	\$ 53,981	\$	(16,274)
CONTRACT COSTS	\$ 66,137	\$ 157,413	\$	91,276
MATERIALS	\$ 142,604	\$ 128,868	\$	(13,736)
OTHER DIRECTS	\$ 211,008	\$ 382,914	\$	171,906
INDIRECTS	\$ 120,461	\$ 90,181	\$	(30,280)
TOTAL LOADED	\$ 610,465	\$ 813,358	\$	202,893

Table 6 compares the Phase 2 WOA estimate and the March 2016 loaded actual costs. The loaded actual costs exceeded the Phase 2 WOA estimate by \$202,893.

The difference between the WOA and the actual costs is attributable to scope changes that occurred after the Phase 2 WOA estimate and unanticipated conditions during construction (including: environmental remediation, additional pipe fabrication, project redesign, resource availability, and material delays); and an early cost estimating tool and process that was based on preliminary project designs (resulting in underestimating of construction costs,

Pipeline Safety Enhancement Plan Workpaper Supporting Chapter V
SANTA FE SPRINGS STATION VALVE PROJECT

project management, and support services). These increased costs were reasonably incurred to complete this valve enhancement work, but were not accounted for in the Stage 3 estimate.

Pipeline Safety Enhancement Plan Workpaper Supporting Chapter V
SANTA FE SPRINGS STATION VALVE PROJECT

Conclusion

SoCalGas and SDG&E enhanced the safety of their natural gas system by prudently executing the Santa Fe Springs Station Valve Project. Through this valve enhancement project, SoCalGas and SDG&E successfully upgraded one valve and installed two check valves. The project incurred a total loaded project cost of \$813,358.

SoCalGas and SDG&E executed this project prudently: bundling valve projects together to capture efficiencies; and responding to numerous unanticipated field changes and conditions including scope modifications, delays, redesigns, and necessary environmental abatement.

SoCalGas and SDG&E's total loaded project cost of \$813,358 is reasonable and should be approved. SoCalGas and SDG&E engaged in prudent cost management efforts (combining projects into a comprehensive bid package); engaged in reasonable efforts to promote competitive and market-based rates for contractor services and materials (see Chapter II (Phillips) (approximately 98% of PSEP agreements with contractors and suppliers were either competitively bid or through agreements entered into using market-based rates based on a recent competitive sourcing event); and used a reasonable amount of company and contractor resources given the conditions experienced in the field and resultant scope changes and delays.

End of Santa Fe Springs Station Valve Project Workpaper

Pipeline Safety Enhancement Plan Workpaper Supporting Chapter V
SGV – FERN & WALNUT VALVE PROJECT

Summary

Table 1: Summary of SGV – Fern & Walnut Valve Project

Project Name	SGV – Fern & Walnut Valve Project
WOA Number	91016
WOA Date	May 22, 2014
City	Rosemead
Construction Start	February 9, 2015
NOP Date	October 30, 2015
Total Loaded Capital Costs	\$5,783,560
Total Loaded O&M Costs	\$ 0
Total Loaded Project Costs	\$5,783,560

Description

Through the SGV - Fern & Walnut Valve Project, SoCalGas and SDG&E enhanced its natural gas transmission system by upgrading three valves, as shown in Table 2 and Figure 1. These three valve enhancements are summarized as follows:

- Mainline Valve 2002-6.81-0 along Line 2002 was replaced and upgraded to include a standard PSEP technology suite enabling both ASV and RCV functionality.
- Bridle Crossover Valve 2002-6.81-1 was replaced and upgraded with an actuator and remote control capability.
- Bridle Crossover Valve 2002-6.81-2 was replaced and upgraded with an actuator and remote control capability.

Examples of cost avoidance actions included:

- SoCalGas and SDG&E negotiated with another Performance Partner to reach an acceptable agreement after the bid from the first performance partner was not accepted.

Pipeline Safety Enhancement Plan Workpaper Supporting Chapter V
SGV – FERN & WALNUT VALVE PROJECT

- SoCalGas and SDG&E considered two locations for the automation for this valve project and the option selected avoided higher costs, a longer lead time and other challenges.
- SoCalGas and SDG&E negotiated with City of Rosemead to reduce permit costs.
- SoCalGas and SDG&E were able to utilize a nearby SoCalGas-owned property for a construction laydown yard for the fabrication and testing of the valve assembly, thus minimizing third party real estate fees.

Construction began in February 2015 and was completed in June 2015. The SGV – Fern & Walnut Valve Project incurred a total loaded project cost of \$5,783,560.

Table 2: SGV – Fern & Walnut Valve Project Final Scope

Line	Valve ID	Valve Type	Installation Type	Function	Valve Size (inches)
2002	2002-6.81-0	Ball	NV/VT	ASV/RCV	■
2002	2002-6.81-1	Ball	NV/VT	RCV	■
2002	2002-6.81-2	Ball	NV/VT	RCV	■

Pipeline Safety Enhancement Plan Workpaper Supporting Chapter V
SGV – FERN & WALNUT VALVE PROJECT

Figure 1: Satellite Image of SGV – Fern & Walnut Valve Project



Pipeline Safety Enhancement Plan Workpaper Supporting Chapter V
SGV – FERN & WALNUT VALVE PROJECT

Stages 1 and 2 – Project Initiation

Table 3: 2011 PSEP Filing

2011 PSEP Filing					
Line	Mile	Valve ID	Valve Size (inches)	Function	Installation Type
2002	6.81	2002-6.81-0	24	ASV/RCV	NV/NP
2002	6.81	2002-6.81-2	20	RCV	NV/NP
767	5.45	767-5.45-0	30	ASV/RCV	A/VT

In workpapers supporting the 2011 PSEP filing,¹ SoCalGas and SDG&E identified mainline valve 2002-6.81-0, bridle crossover valve 2002-6.81-2, and mainline valve 767-5.45-0 as a PSEP valve enhancement project.

The SGV – Fern & Walnut Valve Project is located near the intersection of Fern Avenue and Walnut Grove Avenue in the city of Rosemead.

Table 4: SGV – Fern & Walnut Valve Project Stage 1 and 2 Scope

Stage 1 and 2 Scope							
Line	Mile	Valve #	Valve ID	Valve Size (inches)	Valve Type	Function	Installation Type
2002	6.81	0	2002-6.81-0	■	Ball	ASV/RCV	NV/VT
2002	6.81	1	2002-6.81-1	■	Ball	RCV	NV/VT
2002	6.81	2	2002-6.81-2	■	Ball	RCV	NV/VT

During Stages 1 and 2, SoCalGas and SDG&E completed scope validation, detailed scope development, and initial project coordination tasks to prepare for engineering, design, and construction of the SGV – Fern & Walnut Valve Project.

¹ See December 2, 2011, Amended Pipeline Safety Enhancement Plan (PSEP) of SoCalGas and SDG&E.

Pipeline Safety Enhancement Plan Workpaper Supporting Chapter V

SGV – FERN & WALNUT VALVE PROJECT

The scope validation review of documentation related to the SGV – Fern & Walnut Valve Project and site visits indicated that:

- In 2011, mainline valve 2002-6.81-0, bridle crossover valve 2002-6.81-2, and mainline valve 767-5.45-02 were identified in SoCalGas and SDG&E's 2011 PSEP workpapers as a PSEP valve enhancement project.
- Prior to project initiation, SoCalGas conducted a flow analysis of the transmission system and determined that this location would require RCV installation of bridle crossover valve 2002-6.81-1 in order to achieve pipeline isolation. This upgrade was required to prevent backflow into the isolated section from the other side of mainline valve 2001-6.81-0, as well as Line 767, which is connected to Line 2002 via the bridled crossovers. Accordingly, bridle crossover valve 2002-6.81-1 was included in the project scope.
- Mainline valve 767-5.45-0 was determined to be normally closed and only open for pigging operation. Mainline valve 767-5.45-0 was therefore de-scoped from the project.

Engineering Factors

Preliminary site visits and existing drawing evaluation resulted in the following findings:

- Mainline valve 2002-6.81-0 was an existing [REDACTED] buried main line ball valve on Line 2002 that was manually operated and normally in the open position. Its current orientation was operationally undesirable for automation due to its location being in the middle of the street.
- Bridle crossover valve 2002-6.81-1 was an existing [REDACTED] buried bridle ball valve on Line 2002 that was bridled to Line 767, and was manually operated and normally in the open position. Its current orientation was operationally undesirable for automation due to its location being in the middle of the street.

Pipeline Safety Enhancement Plan Workpaper Supporting Chapter V

SGV – FERN & WALNUT VALVE PROJECT

- Bridle crossover valve 2002-6.81-2 was an existing [REDACTED] buried valve on Line 2002 bridled to Line 767. It was manually operated and normally in the open position. This drove the decision to replace a valve where orientation can be dictated and avoid excavating a valve.
- Utility power and data communications connections are available on site.
- Analysis of existing drawings for the SGV – Fern & Walnut Valve Project revealed the location of existing below ground pipe and conduit locations.

SoCalGas and SDG&E conducted an in-depth site evaluation including a field visit, and further reviewed the existing drawings. Through engineering analysis, SoCalGas and SDG&E determined long lead items and communication and power needs and further refined the scope as follows:

- The valve size for mainline valve 2002-6.81-0 was confirmed to be a [REDACTED] valve.
- The installation type for valves 2002-6.81-0.00 and 2002-6.81-2 was changed from NV/NP to NV/VT. This change was based on the existing valves being buried under Walnut Avenue adjacent to the sidewalk and that a vault would be needed to house the new actuators.

Based on the above findings and resulting scope changes, two location options were explored for installation:

- Option 1: Relocate the valve assembly to adjacent vacant private property and install above grade actuators.
- Option 2: Automate the valves in existing location with actuators installed in a vault in the sidewalk (note, the valves may still require re-orientation and/or replacement).

At the end of Stage 2, Option 2 was selected. Option 1 was rejected due to the long lead time and difficulty associated with obtaining exclusive easements from the adjacent private property owner.

Pipeline Safety Enhancement Plan Workpaper Supporting Chapter V

SGV – FERN & WALNUT VALVE PROJECT

Stage 3 – Initial Planning and Design

During Stage 3, SoCalGas and SDG&E developed a Phase 2 WOA estimate, completed preliminary design drawings and further refined the scope. Preliminary drawings were also used to initiate procurement of long lead materials.

Planning and Design Activity

The design for the SGV – Fern & Walnut Valve Project was planned as follows:

Mainline Valve 2002-6.81-0

- Install new [REDACTED] ball valve (see figure 2).
- Install pneumatic actuator in new vault.
- Install new line break control panel equipped with standardized PSEP ASV technology.
- Install a SCADAPack panel equipped with remote control technology.
- Install associated tubing, conduit, cable, utility power, and data communications.

Bridle Crossover Valve 2002-6.81-1

- Install new [REDACTED] ball valve.
- Install pneumatic actuator in a new vault.
- Install associated tubing, conduit, cable, and instrumentation.

Bridle Crossover Valve 2002-6.81-2

- Install new [REDACTED] ball valve.
- Install pneumatic actuator (to be installed in the same new vault associated with the mainline valve 2002-6.81-0 actuator).
- Install associated tubing, conduit, and cable.

Pipeline Safety Enhancement Plan Workpaper Supporting Chapter V

SGV – FERN & WALNUT VALVE PROJECT

Cost Avoidance

- SoCalGas site inspected and considered two options for locating the valve automation in this project. The option ultimately selected avoided the challenges associated with obtaining easements and long lead time on materials.
- SoCalGas negotiated with City of Rosemead and reduced the permit costs.
- In finding an acceptable site for the construction laydown yard, a SoCalGas-owned property was considered. It was determined that operations could be adjusted that would allow for the fabrication and testing of the valve assembly on site, thus minimizing third party real estate fees.

Additional Considerations

- Valve and pipe assembly will be replaced “in place” without a change in elevation.
- Actuators and vaults can be installed at the current elevation of valve assembly.
- Utility power would be available as this is a street site and Combination Service Entrance Device (CSED) can be mounted against the SCADA panel.

Estimate of Costs

The preliminary estimate of the total loaded cost to complete the scope of work for the SGV – Fern & Walnut Valve Project as described above was \$3,356,218, as shown in Table 5. This estimate was prepared in May 2014 using Stage 3 SCG Valve Estimate Template Rev 0 estimating tool and is based on preliminary design work.

Pipeline Safety Enhancement Plan Workpaper Supporting Chapter V
SGV – FERN & WALNUT VALVE PROJECT

Table 5: SGV – Fern & Walnut Valve Project Phase 2 WOA Estimate

Cost Category	Phase 2 WOA
Company Labor Costs	\$272,192
Contract Costs	\$1,189,926
Material Costs	\$556,389
Other Direct Costs	\$748,412
Total Direct Costs	\$2,766,919
Total Indirect Costs	\$589,299
Total Loaded Costs	\$3,356,218

Pipeline Safety Enhancement Plan Workpaper Supporting Chapter V
SGV – FERN & WALNUT VALVE PROJECT

Stage 4 – Detailed Engineering Design and Procurement

During Stage 4, SoCalGas and SDG&E developed and completed detailed engineering design work, selected a construction contractor, and prepared for project construction.

Detailed Planning and Design

Ongoing engineering design, field and in-house research indicated that the assumption in the proposed Stage 1 and 2 designs would not work at the SGV – Fern & Walnut Valve Project. After sizing the actuators and vaults, it was determined that this location for the existing valve assembly was too shallow to allow for installation of actuators and vaults. The scope was modified in Stage 4 to lower the mainline valve and bridle assembly in a new vault. This revised scope required a reengineered piping and vault design. To accommodate the space needs of the actuator and its housing vault, the pipe needed to be lowered to a depth of 14 feet from 8 feet.

Construction Contractor Selection

The construction contract negotiations were initially with the assigned Performance Partner. When the bid from the first performance partner was deemed unacceptable, SoCalGas and SDG&E negotiated with another Performance Partner to reach an acceptable agreement.

The Performance Partner/Construction Contractors' TPE was \$ [REDACTED], which is \$ [REDACTED] more than the Stage 3 construction contractor direct estimate of \$ [REDACTED] that was used to develop the Phase 2 WOA

Pipeline Safety Enhancement Plan Workpaper Supporting Chapter V
SGV – FERN & WALNUT VALVE PROJECT

Stage 5 – Construction

Schedule

Construction Start Date: 02/09/2015

Construction Finish Date: 06/05/2015

NOP Date: 10/30/2015

The construction of the SGV – Fern & Walnut Valve Project required 10 more days than was planned.

Field Conditions

Conditions were encountered in the field that were not anticipated during design and planning that had to be addressed or mitigated. These conditions impacted the project scope and schedule and added to the project costs.

Substructures:

- Unforeseen reinforced concrete vault floor was encountered under Line 2002, requiring the concrete to be removed so that the work on the project could continue.

Constructability Issues:

- Pipeline isolation and tie-in durations were longer than anticipated. The original estimate was 66 hours; however, the actual tie-in hours were 113 hours.
- Slide rail shoring could not be engineered due to existing substructures. H-piles were used instead.

Pipeline Safety Enhancement Plan Workpaper Supporting Chapter V
SGV – FERN & WALNUT VALVE PROJECT

Permit Conditions:

- The city required SoCalGas to grind and cap the street, with the use of thermoplastic striping, for restoration of asphalt. This requirement was not known when the estimate was originally created and added costs.

Equipment Conditions:

- Installation of excess flow valves on the 3/4-inch tubing inside the vaults for all three valve actuators.
- Installation of 3/8-inch tubing inside the 4-inch vent lines for the 3/4-inch exhaust lines coming into the vaults from the remote control valve regulator cabinet and line break cabinet.
- Installation of Myers Utility Pedestal because the local electric utility would not accept a CSED panel mount on the SCADA Panel. This requirement was unknown during the design phase of the project.

Pipeline Safety Enhancement Plan Workpaper Supporting Chapter V
SGV – FERN & WALNUT VALVE PROJECT

Figure 2: Existing 30" MLV 2002-6.81-0 and 20" Crossover valve 2002-6.81-2 prior to replacement. Blowdown valves are also shown. This large assembly was replaced and the newly installed 30" MLV, and 20" and 16" Crossover valves were automated.



Pipeline Safety Enhancement Plan Workpaper Supporting Chapter V
SGV – FERN & WALNUT VALVE PROJECT

Stages 6 and 7 – Commissioning and Closeout

Commissioning activities included site restoration, final inspections, and placement of the valves back into service. During this stage, SoCalGas and SDG&E successfully performed site acceptance testing and conducted point-to-point verification with SoCalGas Gas Control for each valve that had been automated. SoCalGas Field Operations personnel were trained on the use of new equipment. Close out activities included development of final drawings, the reconciliation package and updates to company systems to reflect the changes made to the system.

Cost Variance

Table 6: SGV – Fern & Walnut Valve Project Phase 2 WOA Estimate and Actual Costs

COST SUMMARY				
	PHASE 2 WOA	CAPITAL (actuals)	DELTA over/(under)	
COMPANY LABOR	\$ 272,192	\$ 270,168	\$ (2,024)	
CONTRACT COSTS	\$ 1,189,926	\$ 2,844,205	\$ 1,654,279	
MATERIALS	\$ 556,389	\$ 623,011	\$ 66,622	
OTHER DIRECTS	\$ 748,412	\$ 1,376,191	\$ 627,779	
INDIRECTS	\$ 589,299	\$ 669,986	\$ 80,687	
TOTAL LOADED	\$ 3,356,218	\$ 5,783,560	\$ 2,427,342	

Table 6 compares the Phase 2 WOA estimate and the March 2016 loaded actual costs. The loaded actual costs exceeded the Phase 2 WOA estimate by \$2,427,342.

The above variance is attributable to scope changes and unanticipated conditions that occurred after the Phase 2 WOA estimate (These included: the redesign to lower the mainline valve and bridle assembly in a new vault, unforeseen reinforced vault floor requiring removal, the change in shoring design, addition equipment determined to be necessary inside and adjacent to the vaults and extended tie-in durations) and an early cost estimating tool and process that was based on preliminary project designs (resulting in underestimation of construction, inspection

Pipeline Safety Enhancement Plan Workpaper Supporting Chapter V
SGV – FERN & WALNUT VALVE PROJECT

and engineering costs). These increased costs were reasonably incurred to complete the project, but were not accounted for in the Stage 3 estimate.

Pipeline Safety Enhancement Plan Workpaper Supporting Chapter V
SGV – FERN & WALNUT VALVE PROJECT

Conclusion

SoCalGas and SDG&E enhanced the safety of their natural gas system by prudently executing the SGV – Fern & Walnut Valve Project. Through this project, SoCalGas and SDG&E successfully upgraded three valves. The project incurred a total loaded cost of \$5,783,560.

SoCalGas and SDG&E executed this project prudently: engaging in prudent cost avoidance efforts; considering two locations for the automation for this valve project and selecting the option that avoided higher costs, a longer lead time and other challenges; and negotiating with the local permitting jurisdiction to reduce costs.

SoCalGas and SDG&E's total loaded project cost of \$5,783,560 is reasonable and should be approved. SoCalGas and SDG&E engaged in prudent cost avoidance efforts as discussed above; engaged in reasonable efforts to promote competitive and market-based rates for contractor services and materials (see Chapter II (Phillips) (approximately 98% of PSEP agreements with contractors and suppliers were either competitively bid or through agreements entered into using market-based rates based on a recent competitive sourcing event)); and used a reasonable amount of company and contractor resources given the work scope changes (unforeseen reinforced vault floor requiring removal; pipeline isolation and tie-in durations requiring more time than anticipated; modifying the design to use H-piles rather than slide rail shoring; unanticipated street repair requirements; installation of additional equipment determined to be necessary inside and adjacent to the vaults; and installation of a Myers Utility Pedestal due to the local electric utility not accepting the proposed CSED panel mount on the SCADA Panel).

End of SGV – Fern and Walnut Valve Project

Pipeline Safety Enhancement Plan Workpaper Supporting Chapter V
VICTORIA STATION VALVE PROJECT

Summary

Table 1: Summary of Victoria Station Valve Project

Project Name	Victoria Station Valve Project
WOA Number	91045
WOA Date	May 21, 2014
City	Los Angeles
Construction Start	December 10, 2014
NOP Date	June 16, 2015
Total Loaded Capital Costs	\$1,734,650
Total Loaded O&M Costs	\$ 0
Total Loaded Project Costs	\$1,734,650

Description

Through the Victoria Station Valve Project, SoCalGas and SDG&E enhanced its natural gas transmission system by upgrading three valves and installing a flow meter, as shown in Table 2 and Figure 1.

These system enhancements are summarized as follows:

- Mainline Valve 1202-7.60-0 along Line 1202 was upgraded to include a standard PSEP technology suite, enabling both ASV and RCV functionality.
- Mainline Valve 1014-27.69-0 along Line 1014 was upgraded to include a standard PSEP technology suite, enabling both ASV and RCV functionality.
- Mainline Valve 2006-5.53-0 along Line 2006 was upgraded to include a standard PSEP technology suite, enabling both ASV and RCV functionality.
- A flow meter along Line 2006 was installed to monitor flow through the main line and assist in determining the location of a potential damage.

Pipeline Safety Enhancement Plan Workpaper Supporting Chapter V
VICTORIA STATION VALVE PROJECT

Construction began in December 2014 and was completed in April 2015. The Victoria Station Valve Project incurred a total loaded project cost of \$1,734,650.

Table 2: Victoria Station Valve Project Final Scope

Line	Valve ID	Valve Type	Installation Type	Function	Valve Size (inches)
1202	1202-7.6-0	Ball	A/VT	ASV/RCV	■
1014	1014-27.69-0	Ball	A/AG	ASV/RCV	■
2006	2006-5.53-0	Ball	C/P	ASV/RCV	■
2006	N/A	N/A	Flow Meter	Flow Meter	NA

Pipeline Safety Enhancement Plan Workpaper Supporting Chapter V
VICTORIA STATION VALVE PROJECT

Figure 1: Satellite Image of Victoria Station Valve Project



Pipeline Safety Enhancement Plan Workpaper Supporting Chapter V
VICTORIA STATION VALVE PROJECT

Stages 1 and 2 – Project Initiation, Analysis, and Findings

Table 3: 2011 PSEP Filing

2011 PSEP Filing					
Line	Mile	Valve ID	Valve Size (inches)	Installation Type	Function
1202	7.60	1202-7.60-0	■	A/AG	ASV/RCV
1014	27.69	1014-27.69-0	■	A/AG	ASV/RCV
2006	5.54	2006-5.54-0*	■	NV/TV	ASV/RCV

In the workpapers supporting the 2011 PSEP filing,¹ SoCalGas and SDG&E identified mainline valves 1202-7.60-0, 1014-27.69-0 and 2006-5.54-0 as a PSEP valve enhancement project. These mainline valves are located at Victoria Station near the border of the cities of Compton and Carson, and provide isolation of transmission pipeline segments in the event of an emergency.

Table 4: Victoria Station Valve Project Stage 1 and 2 Scope

Stage 1 and 2 Scope							
Line	Mile	Valve #	Valve ID	Valve Size (inches)	Valve Type	Installation Type	Function
1202	7.6	0	1202-7.60-0	■	Ball	A/VT	ASV/RCV
1014	27.69	0	1014-27.69-0	■	Ball	A/AG	ASV/RCV
2006	5.53	0	2006-5.53-0*	■	Ball	C/P	ASV/RCV

**As discussed below, Valve 2000-5.54-0 was descoped from the project and Valve 2006-5.53-0 was added to the scope.*

¹ See December 2, 2011, Amended Pipeline Safety Enhancement Plan (PSEP) of SoCalGas and SDG&E.

Pipeline Safety Enhancement Plan Workpaper Supporting Chapter V

VICTORIA STATION VALVE PROJECT

During Stages 1 and 2, SoCalGas and SDG&E completed scope validation, detailed scope development and initial project coordination tasks to prepare for engineering, design, and construction of the Victoria Station Valve Project.

The scope validation review of documentation related to the Victoria Station Valve Project and site visits indicated that:

- In 2011, mainline valves 1202-7.60-0, 2006-5.54-0, and 1014-27-69-0 located at Victoria Valve Station, were identified in SoCalGas and SDG&E's 2011 PSEP workpapers as a PSEP valve enhancement project.
- Mainline valve 2006-5.54-0 was already equipped with RCV technology and was de-scoped from the project. However, an additional mainline valve, 2006-5.53-0 was identified as being necessary for the project in order to provide proper isolation of this transmission pipeline segment.
- Victoria Street Valve Station was retrofitted by SoCalGas Pipeline Integrity in 2006, at which time mainline valves 1202-7.60-0, 2006-5.53-0 and 1014-27.69-0 were replaced with ball valves in order to accommodate the use of in-line inspection technology.
- Mainline valve 1202-7.60-0 was manually operated and was normally in the open position. It was located in a vault in the middle of a paved access road and an above ground actuator would not be feasible at this location.
- Mainline valve 1014-27.69-0 was manually operated and was normally in the open position.
- Mainline Valve 2006-5.53-0 was pneumatically actuated and was normally in the open position.

Pipeline Safety Enhancement Plan Workpaper Supporting Chapter V
VICTORIA STATION VALVE PROJECT

SoCalGas and SDG&E conducted an in-depth site evaluation, including a field visit, and further reviewed the existing drawings. Through engineering analysis, SoCalGas and SDG&E determined long lead items, communication and power needs, and refined the scope as follows:

- The installation type for mainline valve 1202-7.60-0 changed from A/AG to A/VT due to the fact that the location of the proposed actuator was in the middle of the paved access road. The new actuator had to be placed in a vault to maintain access.

Pipeline Safety Enhancement Plan Workpaper Supporting Chapter V
VICTORIA STATION VALVE PROJECT

Stage 3 – Initial Planning and Design

Table 5: Victoria Station Valve Project Stage 3 Scope

Stage 3 Scope							
Line	Mile	Valve Number	Valve ID	Valve Size (inches)	Valve Type	Installation Type	Function
1202	7.6	0	1202-7.60-0	██████	Ball	A/VT	ASV/RCV
1014	27.69	0	1014-27.69-0	██████	Ball	A/AG	ASV/RCV
2006	5.53	0	2006-5.53-0	██████	Ball	CP	ASV/RCV
2006	NA	NA	NA	██████	Flow Meter	Flow Meter	Meter

Planning and Design Activity

During Stage 3, it had been determined by SoCalGas’ Engineering department through continued system analysis that upgrades were required to identify and isolate potential breaks along the transmission line and the following component was added to the scope:

- Installation of a new flow meter on Line 2006

As such, these three valves and the flow meter located at Victoria Station were grouped into one project bundle for planning and construction efficiency. This bundled project is referred to as the Victoria Station Valve Project.

The design for Victoria Valve Station Project was planned as follows:

Mainline Valve 1202-7.60-0

- Remove old vault and install new larger vault.
- Install new direct mount double acting pneumatic actuator.
- Install new line break control panel equipped with standardized PSEP ASV technology.

Pipeline Safety Enhancement Plan Workpaper Supporting Chapter V
VICTORIA STATION VALVE PROJECT

- Install new SCADA Pack panel equipped with remote control technology.
- Install associated tubing, conduit, cable, utility power, and data communications.

Mainline Valve 1014-27.69-0

- Install new line break control panel equipped with standardized PSEP ASV technology.
- Install associated tubing, conduit, cable, utility power, and data communications.

Mainline Valve 2006-5.53-0

- Install new line break control panel equipped with standardized PSEP ASV technology.
- Install associated tubing, conduit, cable, utility power, and data communications.

Ultrasonic Flow Meter on Line 2006

- Install new Ultrasonic Clamp-On Flow Meter.
- Install all ¾-in. piping and fittings from vault to pressure transmitter.

Estimate of Costs

The Phase 2 WOA estimate of the total loaded cost to complete the scope of work for the Victoria Station Valve Project as described above was \$1,093,327, as shown in Table 6. This estimate was prepared in May 2014 using the Stage 3 SCG Valve Estimate Template Rev 0 estimating tool and is based on preliminary design work.

Pipeline Safety Enhancement Plan Workpaper Supporting Chapter V
VICTORIA STATION VALVE PROJECT

Table 6: Victoria Station Valve Project Phase 2 WOA Estimate

Cost Category	Phase 2 WOA
Company Labor	\$83,953
Contract Costs	\$324,313
Material Costs	\$157,941
Other Direct Costs	\$337,036
Total Direct Costs	\$903,243
Total Indirect Costs	\$190,084
Total Loaded Costs	\$1,093,327

Pipeline Safety Enhancement Plan Workpaper Supporting Chapter V
VICTORIA STATION VALVE PROJECT

Stage 4 – Detailed Engineering Design and Procurement

During Stage 4, SoCalGas and SDG&E developed and completed detailed engineering design work, selected a construction contractor and prepared for project construction.

Detailed Planning and Design

No scope changes occurred from Stage 3 to Stage 4.

Construction Contractor Selection

The mechanical contract was awarded to the PSEP performance partner contractor for this assigned area. The electrical contract was awarded to the approved Alliance contractor for this project.

The Performance Partner/Construction Contractors' TPE was \$ [REDACTED] which is \$ [REDACTED] more than the Stage 3 construction contractor direct estimate of \$ [REDACTED] that was used to develop the Phase 2 WOA.

Pipeline Safety Enhancement Plan Workpaper Supporting Chapter V
VICTORIA STATION VALVE PROJECT

Stage 5 – Construction

Schedule

Construction Start: 12/10/2014

Construction Finish: 04/24/2015

NOP Date: 06/16/2015

Field Conditions

Conditions were encountered in the field that were not anticipated during design and planning that had to be addressed or mitigated. Listed below is a summary of the key field changes broken down by type of change for this project:

Environmental:

- Asbestos contamination was found in the excavation, which required remediation prior to construction.

Materials:

- The vault vendor's vault design did not meet SoCalGas and SDG&E design criteria. The vendor's effort to generate an approved design was prolonged, resulting in a two-month delay in the delivery of the vault. To mitigate the schedule delay, SoCalGas accelerated the electrical construction schedule. This allowed the construction start date to remain the same instead of being delayed by two months for the vault.

Substructures:

- After excavation, pin-off tees were discovered on the pipe that interfered with the setting of the vault. This required the vault to be rotated 90 degrees. This rotation required several modifications to be made to the vault.

Pipeline Safety Enhancement Plan Workpaper Supporting Chapter V
VICTORIA STATION VALVE PROJECT

Constructability Issues:

- The bollards required redesign due to the fact underground conduits were discovered under the proposed location of new traffic bollards. This resulted in additional pavement cutting and a bollard redesign.

Pipeline Safety Enhancement Plan Workpaper Supporting Chapter V
VICTORIA STATION VALVE PROJECT

Stages 6 and 7 – Commissioning and Closeout

Commissioning activities included site restoration, final inspections, and placement of the valves back into service. During this stage, SoCalGas and SDG&E successfully performed site acceptance testing and conducted point-to-point verification with SoCalGas Gas Control for each valve that had been automated. SoCalGas Field Operations personnel were trained on the use of new equipment. Close out activities included development of final drawings, the reconciliation package and updates to company systems to reflect the changes made to the system.

Cost Variance

Table 7: Victoria Station Valve Project Phase 2 WOA Estimate and Actual Costs

COST SUMMARY				
	PHASE 2 WOA	CAPITAL (actuals)	DELTA over/(under)	
COMPANY LABOR	\$ 83,953	\$ 128,141	\$ 44,188	
CONTRACT COSTS	\$ 324,313	\$ 706,103	\$ 381,790	
MATERIALS	\$ 157,941	\$ 172,450	\$ 14,509	
OTHER DIRECTS	\$ 337,036	\$ 523,166	\$ 186,130	
INDIRECTS	\$ 190,084	\$ 204,790	\$ 14,706	
TOTAL LOADED	\$ 1,093,327	\$ 1,734,650	\$ 641,323	

Table 7 compares the Phase 2 WOA estimate and the March 2016 loaded actual costs. The loaded actual costs exceeded the Phase 2 WOA estimate by \$641,323.

The difference between the WOA and the actual costs is attributable to scope changes that occurred after the Phase 2 WOA estimate and unanticipated conditions during construction (including: identification of asbestos in the excavation, delays due to vendor vault design, identification of substructures required vault rotation, and bollard redesign upon identification of nearby underground conduits) and an early cost estimating tool and process that was based on preliminary project designs (resulting in underestimating of construction costs, inspection costs,

Pipeline Safety Enhancement Plan Workpaper Supporting Chapter V
VICTORIA STATION VALVE PROJECT

and project support costs). These increased costs were reasonably incurred to complete this valve enhancement work, but were not accounted for in the Stage 3 estimate.

Pipeline Safety Enhancement Plan Workpaper Supporting Chapter V
VICTORIA STATION VALVE PROJECT

Conclusion

SoCalGas and SDG&E enhanced the safety of their natural gas system by prudently executing the Victoria Station Valve Project. Through this valve enhancement project, SoCalGas and SDG&E successfully upgraded three valves and installed one flowmeter. The project incurred a total loaded project cost of \$1,734,650.

SoCalGas and SDG&E executed this project prudently by bundling three valves and a flow meter together for planning and construction efficiency. SoCalGas and SDG&E's total loaded project cost of \$1,734,650 is reasonable and should be approved. SoCalGas and SDG&E engaged in reasonable efforts to promote competitive and market-based rates for contractor services and materials (see Chapter II (Phillips) (approximately 98% of PSEP agreements with contractors and suppliers were either competitively bid or through agreements entered into using market-based rates based on a recent competitive sourcing event)); and used a reasonable amount of company and contractor resources given the work scope changes (asbestos remediation, vault design issues, substructure conflicts requiring vault rotation, and redesign of bollards).

End of Victoria Station Valve Project

Pipeline Safety Enhancement Plan Workpaper Supporting Chapter V
WHITEWATER STATION VALVE PROJECT

Summary

Table 1: Summary of Whitewater Station Valve Project

Project Name	Whitewater Station Valve Project
WOA Number	91023
WOA Date	September 18, 2013
City	Whitewater
Construction Start	March 4, 2014
NOP Date	July 2, 2014
Total Loaded Capital Costs	\$ 815,990
Total Loaded O&M Costs	\$ 0
Total Loaded Project Costs	\$ 815,990

Description

Through the Whitewater Station Valve Project, SoCalGas and SDG&E enhanced its gas transmission system by upgrading three valves as shown in Table 2 and Figure 1. These valve enhancements are summarized as follows:

- Mainline Valve 2000-125.13-0 along Line 2000 was upgraded to include a standard PSEP technology suite enabling both ASV and RCV functionality.
- Mainline Valve 2001-125.13-0 along Line 2001 was upgraded to include a standard PSEP technology suite enabling both ASV and RCV functionality.
- Mainline Valve 2051-126.40-0 along Line 2051 was upgraded to include a standard PSEP technology suite enabling both ASV and RCV functionality.

Example of cost avoidance actions included:

- The Whitewater Station Valve Project was one of nine projects that were combined into a comprehensive bid package for a mechanical and electrical engineering contractor in order to capture efficiencies because the contractors were able to perform work simultaneously at the various sites and could manage work load between projects.

Pipeline Safety Enhancement Plan Workpaper Supporting Chapter V
WHITEWATER STATION VALVE PROJECT

Construction began in March 2014 and was completed in June 2014. The Whitewater Station Valve Project incurred a total loaded project cost of \$815,990.

Table 2: Whitewater Station Valve Project Final Scope

Line	Valve ID	Valve Type	Installation Type	Function	Valve Size (inches)
2000	2000-125.13-0	Ball	C/P	ASV/RCV	■
2001	2001-125.13-0	Ball	C/P	ASV/RCV	■
2051	2051-126.40-0	Ball	C/P	ASV/RCV	■

Pipeline Safety Enhancement Plan Workpaper Supporting Chapter V
WHITEWATER STATION VALVE PROJECT

Figure 1: Satellite image of Whitewater Station Valve Project



Pipeline Safety Enhancement Plan Workpaper Supporting Chapter V
WHITEWATER STATION VALVE PROJECT

Stages 1 and 2 – Project Initiation

Table 3: 2011 PSEP Filing

2011 PSEP Filing					
Line	Mile	Valve ID	Valve Size (inches)	Installation Type	Function
2000	125.13	2000-125.13-0	■	NV/NP	ASV/RCV
2001	125.13	2001-125.13-0	■	C/P	ASV/RCV
2051	126.40	2051-126.40-0	■	C/P	ASV/RCV

In workpapers supporting the 2011 PSEP filing,¹ SoCalGas and SDG&E identified mainline valves 2000-125.13-0, 2001-125.13-0, and 2051-126.40-0 as a PSEP valve retrofit project.

These valves are located at the Whitewater Station in the community of Whitewater in unincorporated Riverside County and provide isolation of pipeline segments in the event of an emergency.

¹ See December 2, 2011, Amended Pipeline Safety Enhancement Plan (PSEP) of SoCalGas and SDG&E.

Pipeline Safety Enhancement Plan Workpaper Supporting Chapter V
WHITEWATER STATION VALVE PROJECT

Table 4: Whitewater Station Valve Project Stage 1 and 2 Scope

Stage 1 and 2 Scope						
Line	Mile	Valve #	Valve ID	Valve Size (inches)	Valve Type	Function
2000	125.13	0	2000-125.13-0	■	Ball	ASV/RCV
2001	125.13	0	2001-125.13-0	■	Ball	ASV/RCV
2051	126.40	0	2051-126.40-0	■	Bal	ASV/RCV

During Stages 1 and 2, SoCalGas and SDG&E completed scope validation, detailed scope development, and initial project coordination tasks to prepare for engineering, design, and construction of the Whitewater Station Valve Project.

The scope validation review of documentation related to the Whitewater Station Valve Project and site visits indicated that:

- In 2011, the mainline valves 2000-125.13-0, 2001-125.13-0, 2051-126.40-0 located at Whitewater Valve Station were identified in SoCalGas and SDG&E’s PSEP workpapers as a PSEP valve enhancement project.
- Mainline valves 2000-125.13-0, 2001-125.13-0 and 2051-126.40-0 were identified as having existing actuators and linebreak technology. However, these valves had no RCV capability and their existing linebreak technology required an upgrade to the current PSEP standard.

SoCalGas and SDG&E conducted an in-depth site evaluation, including a field visit, further reviewed the existing drawings, and determined long lead items, communication and power needs.

Pipeline Safety Enhancement Plan Workpaper Supporting Chapter V
WHITEWATER STATION VALVE PROJECT

Stage 3 – Initial Planning and Design

During Stage 3, SoCalGas and SDG&E developed a Phase 2 WOA estimate, completed preliminary design drawings and further refined the scope. Preliminary drawings were also used to initiate procurement of long lead materials. The design for the Whitewater Station Valve Project was planned as follows:

Mainline Valves 2000-125.13-0, 2001-125.13-0, and 2051-126.40-0:

- Install all tubing and fittings from pipeline to line break control panel.
- Install new line break control panels equipped with standardized PSEP ASV technology.
- Install a SCADAPack panel equipped with remote control technology, which when combined with line break panels, provides both ASV/RCV functionality.
- Install all conduit and cable from line break control panel to new SCADAPack panel inside existing shelter.

Cost Avoidance

- The Whitewater Station Valve Project was one of nine projects that were combined into a comprehensive bid package for a mechanical and electrical engineering contractor in order to capture efficiencies because the contractors were able to perform work simultaneously at the various sites and could manage work load between projects.

Estimate of Costs

The preliminary Phase 2 WOA estimate of the total loaded cost to complete the scope of work for the Whitewater Station Valve Project as described above was \$923,396 as shown in Table 5. This estimate was prepared in September 2013 using the Stage 3 SCG Valve Estimate Template Rev Beta estimating tool and is based on preliminary design work.

Pipeline Safety Enhancement Plan Workpaper Supporting Chapter V
WHITEWATER STATION VALVE PROJECT

Table 5: Whitewater Station Valve Project Phase 2 WOA Estimate

Cost Category	Phase 2 WOA
Company Labor Costs	\$98,927
Contract Costs	\$232,220
Material Costs	\$164,880
Other Direct Costs	\$249,111
Total Direct Costs	\$745,138
Total Indirect Costs	\$178,258
Total Loaded Costs	\$923,396

Pipeline Safety Enhancement Plan Workpaper Supporting Chapter V
WHITEWATER STATION VALVE PROJECT

Stage 4 – Detailed Engineering Design and Procurement

During Stage 4, SoCalGas and SDG&E developed and completed detailed engineering design work, selected a construction contractor, and prepared for project construction.

Detailed Planning and Design

There were no scope changes from Stage 3 to Stage 4.

Construction Contractor Selection

Both a mechanical contractor and an electrical contractor are needed to complete construction of valve enhancement projects. In order to achieve cost and schedule efficiencies, SoCalGas and SDG&E identified nine valve projects that could be combined into two comprehensive bid packages, one for mechanical contractor services and one for electrical contractor services. The nine sites that were combined in this fashion were the Arrow & Haven project; and the Bain, Chino, Haskell, Moreno Large, Moreno Small, Prado, Santa Fe Springs, and Whitewater stations.

The Whitewater Station Valve Project required only electrical contractor services. However, it was included in the nine combined projects for contractor selection, as explained above.

The construction contractor's bid was \$ [REDACTED], which is \$ [REDACTED] less than the the Stage 3 construction contractor direct estimate of \$ [REDACTED] that was used to develop the Phase 2 WOA.

Pipeline Safety Enhancement Plan Workpaper Supporting Chapter V
WHITEWATER STATION VALVE PROJECT

Stage 5 – Construction

Schedule

Construction Start Date: 03/04/2014

Construction Finish Date: 06/10/2014

NOP Date: 07/02/2014

Construction associated with the Whitewater Station Valve Project had no schedule delays.

Field Conditions

Conditions were encountered in the field that were not anticipated during design and planning that had to be addressed or mitigated. Listed below is a summary of the key field changes broken down by type of change for this project:

Equipment Conditions:

- The mainline valves use a two-valve tandem service-monitor configuration. The [REDACTED] piping to the nearest existing tap for instrumentation/power gas was located between the two valves. This piping had to be extended to a different tap beyond the monitor valve to maintain line pressure to the actuator and pressure transmitter in case the monitor valve closed. This condition could have caused isolation from the mainline resulting in incorrect pressure readings and possible loss of power gas to actuate the valve. As a result, a design improvement was necessary to improve functionality: the [REDACTED] pipe was extended to the instrument tap beyond the service-monitor pair to ensure accurate pressure measurement.
- Canopies were added over the line break cabinets for protection from the weather.

Pipeline Safety Enhancement Plan Workpaper Supporting Chapter V
WHITEWATER STATION VALVE PROJECT

Operability:

- Field adjustments to the VRP cabinet were required to address recent field modifications for maintenance that differed from prior drawings.

Materials:

- Corrections were made to the line break panel to adapt to existing operating equipment

Condition of Site:

- The expectation was that the contractor would be trenching through sandy soil; however, very rocky soil conditions were encountered once digging began adding time and expense. Additionally, boulder removal was required at the site.

Pipeline Safety Enhancement Plan Workpaper Supporting Chapter V
WHITEWATER STATION VALVE PROJECT

Stages 6 and 7 – Commissioning and Closeout

Commissioning activities included site restoration, final inspections, and placement of the valves back into service. During this stage, SoCalGas and SDG&E successfully performed site acceptance testing and conducted point-to-point verification with SoCalGas Gas Control for each valve that had been automated. SoCalGas Field Operations personnel were trained on the use of new equipment. Close out activities included development of final drawings, the reconciliation package and updates to company systems to reflect the changes made to the system.

Cost Variance

Table 6: Whitewater Station Valve Project Phase 2 WOA Estimate and Actual Costs

COST SUMMARY				
	PHASE 2 WOA	CAPITAL (actuals)	DELTA over/(under)	
COMPANY LABOR	\$ 98,927	\$ 83,098	\$ (15,829)	
CONTRACT COSTS	\$ 232,220	\$ 192,027	\$ (40,193)	
MATERIALS	\$ 164,880	\$ 139,308	\$ (25,572)	
OTHER DIRECTS	\$ 249,111	\$ 287,073	\$ 37,962	
INDIRECTS	\$ 178,258	\$ 114,484	\$ (63,774)	
TOTAL LOADED	\$ 923,396	\$ 815,990	\$ (107,406)	

Table 6 compares the Phase 2 WOA estimate and the March 2016 loaded actual costs. The Whitewater Station Valve Project resulted in loaded actual costs that were approximately \$107,406 less than the Phase 2 WOA estimate.

The difference between the WOA and the actual costs is attributable to scope changes that occurred after the Phase 2 WOA estimate and unanticipated conditions during construction and an early cost estimating tool and process that was based on preliminary project designs (resulting in overestimating of construction contractor costs).

Pipeline Safety Enhancement Plan Workpaper Supporting Chapter V
WHITEWATER STATION VALVE PROJECT

Conclusion

SoCalGas and SDG&E enhanced the safety of their natural gas system by prudently executing the Whitewater Station Valve Project. SoCalGas and SDG&E successfully upgraded three valves. The project incurred a total loaded project cost of \$815,990.

SoCalGas and SDG&E executed this project prudently by coordinating and bundling nine valve projects into a comprehensive bid package in order to capture efficiencies and responded to numerous unanticipated field changes including unanticipated site conditions, necessary field adjustments, and design changes.

SoCalGas and SDG&E's total loaded project cost of \$815,990 is reasonable and should be approved. SoCalGas and SDG&E engaged in prudent cost avoidance efforts (coordinating valve projects to realize efficiencies); engaged in reasonable efforts to promote competitive and market-based rates for contractor services and materials (see Chapter II (Phillips) (approximately 98% of PSEP agreements with contractors and suppliers were either competitively bid or through agreements entered into using market-based rates based on a recent competitive sourcing event)); and used a reasonable amount of company and contractor resources given the conditions and work scope changes experienced during construction.

End of Whitewater Station Valve Project Workpaper

Pipeline Safety Enhancement Plan Workpaper Supporting Chapter V

LINE 235 W, SUPPLY LINE 44-654 REPLACEMENT AND PALMDALE VALVE PROJECTS

Summary

Table 1: L-235W, SL-44-654 Replacement Projects and Palmdale Valve Project Summary

Project Name	L-235W Replacement Project
WOA Number / Date	91021 / September 1, 2013
City	Palmdale
Original Pipe Diameter/ New Pipe Diameter	██████████ / ██████████
Construction Start / Construction Finish	June 09, 2014 / October 20, 2014
Loaded Capital Costs	\$ 3,975,434
Loaded O&M Costs	\$ 0
Total Loaded Project Costs	\$ 3,975,434
Disallowance	\$ 47,090 (Capital)

Project Name	SL-44-654 Replacement Project
WOA Number / Date	82002 / September 19, 2013
City	Palmdale
Original Pipe Diameter/New Diameter	██████████
Construction Start / Construction Finish	June 09, 2014 / October 20, 2014
Loaded Capital Costs	\$ 2,068,099
Loaded O&M Costs	\$ 0
Total Loaded Project Costs	\$ 2,068,099
Disallowance	\$ 49,300 (Capital)

Pipeline Safety Enhancement Plan Workpaper Supporting Chapter V

LINE 235 W, SUPPLY LINE 44-654 REPLACEMENT AND PALMDALE VALVE PROJECTS

Project Name	Palmdale Valve Project
WOA Number/Date	91037 / December 17, 2013
City	Palmdale
Construction Start / Construction Finish	June 09, 2014 / March 20, 2015
Loaded Capital Costs	\$ 7,513,104
Loaded O&M Costs	\$ 0
Total Loaded Project Costs	\$ 7,513,104
Disallowance	\$ 0

Total Loaded Costs for all 3 projects	\$ 13,556,637
Total Disallowances for all 3 projects	\$ 96,390 (Capital)

Pipeline Safety Enhancement Plan Workpaper Supporting Chapter V

LINE 235 W, SUPPLY LINE 44-654 REPLACEMENT AND PALMDALE VALVE PROJECTS

Background

L-235 West is an approximately 118 mile long high pressure transmission line made up of primarily [REDACTED] pipe that runs through the community of Newberry Springs and ends in the city of Santa Clarita. SL-44-654 is fed from L-235 West in Palmdale, at MLV 235-215.22-0, and feeds the high-to-high pressure Palmdale regulator station. This workpaper addresses L-235 West and SL-44-654 replacement and the Palmdale valve projects. To increase efficiency, minimize the number of blowdowns and to take advantage of an opportunity to lessen customer impact these projects were managed together as one project. Construction was conducted simultaneously and the same mechanical and electrical contractors were utilized for all three projects.

Description

Through the L-235 West, SL-44-654, and 235-335 Palmdale Valve Projects, SoCalGas and SDG&E enhanced its high-pressure transmission pipeline system by successfully replacing approximately 351 feet of pipe, installing 5 new valves, and upgrading one valve as shown in Figures 1-6 and Table 2 which describes the project scope as submitted in the 2011 PSEP filing and the final construction mileage.

Examples of cost avoidance actions included:

- Combining the three projects into one; this allowed for a single contractor to be managed by one project management team. This also allowed for one mobilization and the reduction in the number of blowdowns.
- Minimizing system capacity impacts to customers by combining three projects into one.
- Refurbishing an existing [REDACTED] valve, thereby avoiding cost of a new valve.
- Conducting one post construction pressure test for both L-235W and SL-44-654, rather than conducting two separate pressure test.

Pipeline Safety Enhancement Plan Workpaper Supporting Chapter V

LINE 235 W, SUPPLY LINE 44-654 REPLACEMENT AND PALMDALE VALVE PROJECTS

- Through scope validation efforts, SoCalGas and SDG&E reduced scope mileage by approximately 2.7 miles

Pipeline construction began in June 2014 and was completed in October 2014 with the valves being fully commissioned by December 2015. The L-235W and SL-44-654 Replacement and 235-335 Palmdale Valve Projects incurred a total loaded project cost of \$13,556,637.

Table 2: L-235W & SL-44-654 2011 CPUC Filing and Final Mileage

	Total Mileage	Criteria Mileage	Accelerated Mileage	Incidental Mileage
235W				
2011 PSEP Filing	3.100 mi.	2.744 mi.	0.356 mi.	0
Final Mileage	164 ft.	146 ft.	0	18 ft.
44-654				
2011 PSEP Filing	0.010 mi.	0.010 mi.	0	0
Final Mileage	246 ft.	153 ft.	0	93 ft.*
Total	410 ft.	299 ft.	0	111 ft.

**Incidental includes approximately 76 ft of SL-32-60 (less than 20% SMYS)*

Pipeline Safety Enhancement Plan Workpaper Supporting Chapter V

LINE 235 W, SUPPLY LINE 44-654 REPLACEMENT AND PALMDALE VALVE PROJECTS

Table 3: 235-335 Palmdale Valve Project

Line	Valve ID	Valve Type	Installation Type	Function	Valve Size (inches)
235W	235-209.87-0	Ball	New Valve ¹ and Actuator	Automatic Shut-off Valve With Remote Control	■
335	335-32.36-0	Ball	New Valve and Actuator	Automatic Shut-off Valve With Remote Control	■
235W	235-215.22-0	Ball	New Valve and Actuator ²	Automatic Shut-off Valve With Remote Control	■
335	335-37.73-0	Ball	New Actuator	Automatic Shut-off Valve With Remote Control	■
235W	235-217.85-0	Ball	New Valve and Actuator	Automatic Shut-off Valve With Remote Control	■
335	335-40.36-0	Ball	New Valve and Actuator	Automatic Shut-off Valve With Remote Control	■

¹ The cost for MLV 235-209.87-0 installation and automation is included in the estimate. The actual cost for the installation of the new valve was charged to Gas Transmission Operation (non-PSEP), while the cost of automation was charged to PSEP.

² The cost for the new valve is included as a part of the L-235 W pipeline work.

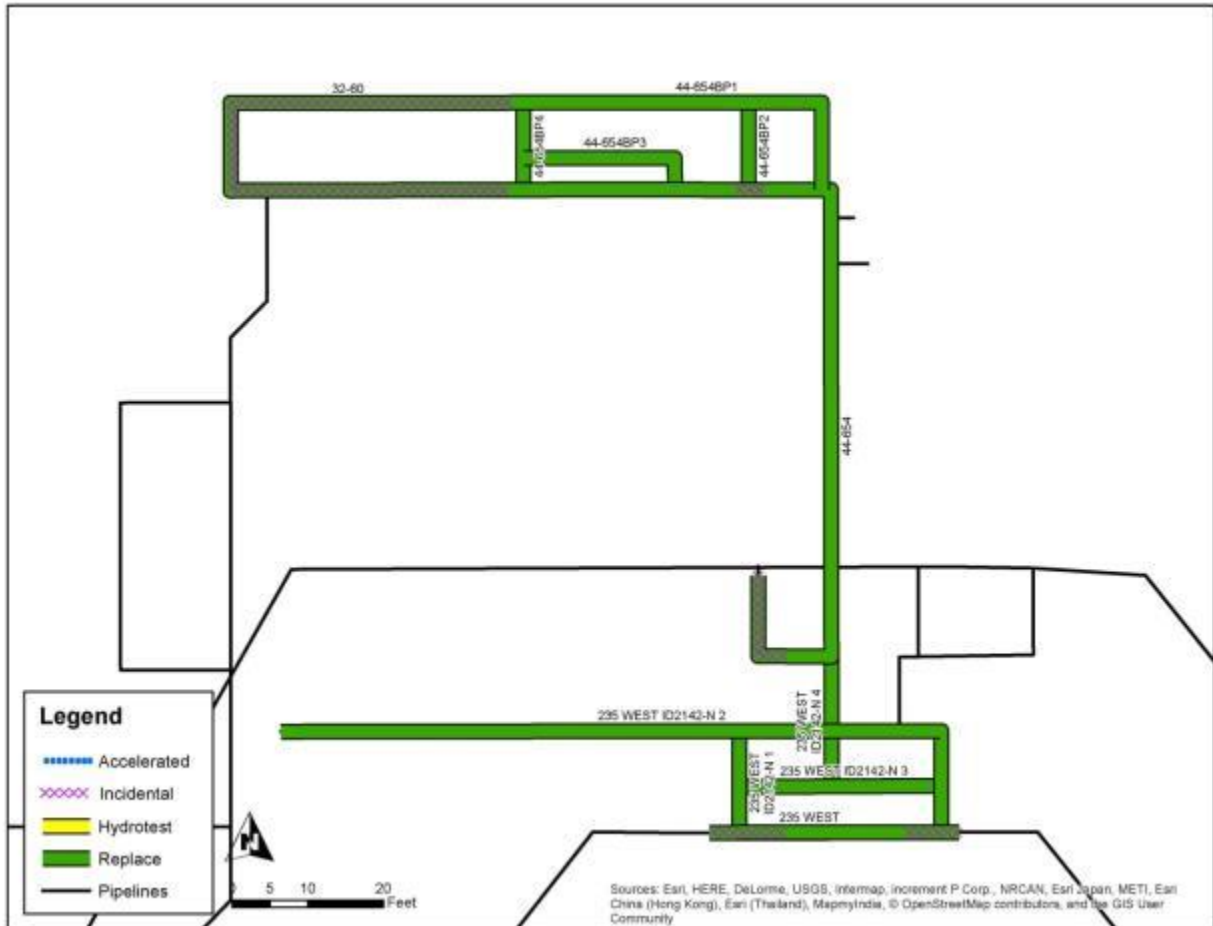
Pipeline Safety Enhancement Plan Workpaper Supporting Chapter V
LINE 235 W, SUPPLY LINE 44-654 REPLACEMENT AND PALMDALE VALVE PROJECTS

Figure 1: Satellite image of L-235, SL44-654 and Palmdale Valve Projects site locations



Pipeline Safety Enhancement Plan Workpaper Supporting Chapter V
LINE 235 W, SUPPLY LINE 44-654 REPLACEMENT AND PALMDALE VALVE PROJECTS

Figure 2: Overview Map of L-235W and SL-44-654 Replacement Project



Pipeline Safety Enhancement Plan Workpaper Supporting Chapter V
LINE 235 W, SUPPLY LINE 44-654 REPLACEMENT AND PALMDALE VALVE PROJECTS

Figure 3: Satellite Image of L-235W and SL-44-654 Replacement Project

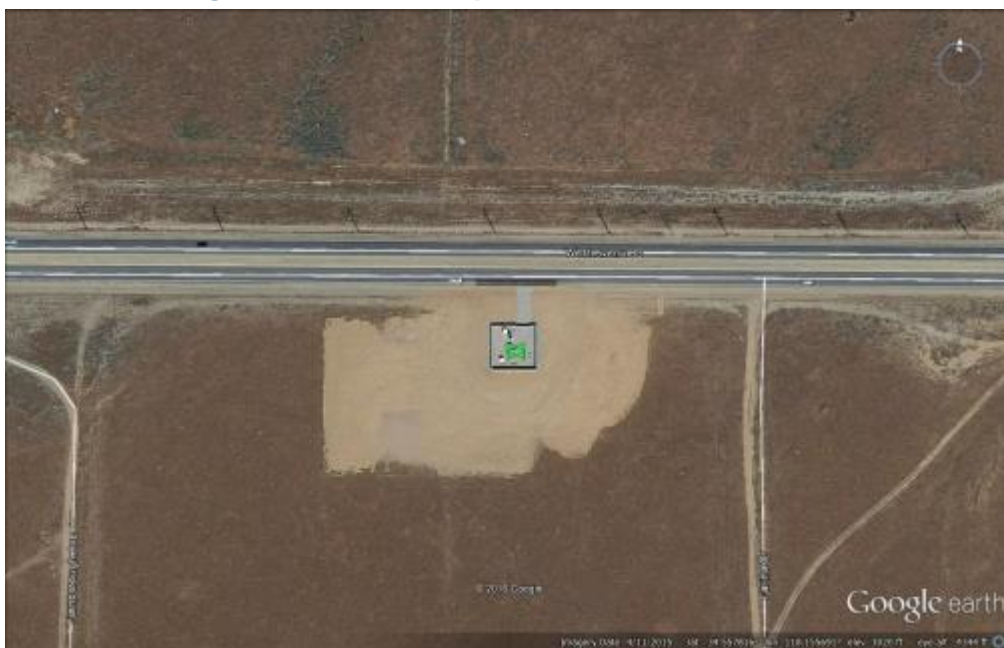


Pipeline Safety Enhancement Plan Workpaper Supporting Chapter V
LINE 235 W, SUPPLY LINE 44-654 REPLACEMENT AND PALMDALE VALVE PROJECTS

Figure 4: Satellite Map of Palmdale Tap Station

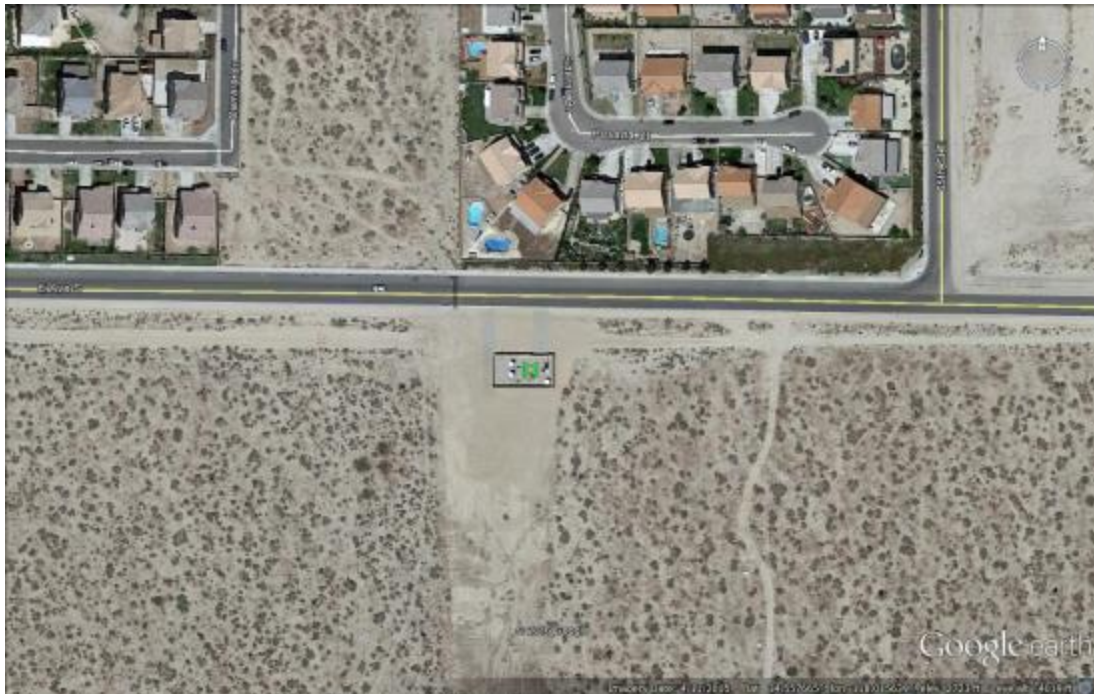


Figure 5: Satellite Map of Palmdale West



Pipeline Safety Enhancement Plan Workpaper Supporting Chapter V
LINE 235 W, SUPPLY LINE 44-654 REPLACEMENT AND PALMDALE VALVE PROJECTS

Figure 6: Satellite Map of Palmdale East



Pipeline Safety Enhancement Plan Workpaper Supporting Chapter V

LINE 235 W, SUPPLY LINE 44-654 REPLACEMENT AND PALMDALE VALVE PROJECTS

Stage 1 – Project Initiation

In workpapers supporting the 2011 PSEP filing,³ SoCalGas and SDG&E identified Line 235 West as a Phase 1A hydrotest project. The scope on the original PSEP filing with the CPUC included 3.1 miles, of which approximately 2.744 miles were Category 4 Criteria and 0.356 miles were accelerated for 235 West. The scope on the original PSEP filing with the CPUC for SL-44-654 as a 53 foot Phase 1A Replacement project and the installation of valves to address geotechnical threats as part of the PSEP Valve Enhancement Plan.

Stage 1, scope validation was performed for the pipelines only. The PSEP Seven Stage Review Process initiates valve scope validation in Stage 2. Pipeline scope validation verified that:

- L-235 West and the Palmdale Regulator Station were installed in 1957.
- Two valves identified at the Palmdale Tap Station required automation upgrades.
- Upon completion of the Stage 1 scope validation, SoCalGas and SDG&E modified the scope of this project as follows:
 - Reduced Category 4 Criteria mileage.
 - Added 160 ft. of accelerated footage (laterals) and 21 ft. of incidental footage for L-235W.
 - Added 53 feet of accelerated mileage and 100 feet of incidental mileages for SL-44-654.
- Added replacement of MLV 235-215.22-0 which was not suitable for automation.

³ See December 2, 2011 Amended Pipeline Safety Enhancement Plan (PSEP) of SoCalGas and SDG&E.

Pipeline Safety Enhancement Plan Workpaper Supporting Chapter V

LINE 235 W, SUPPLY LINE 44-654 REPLACEMENT AND PALMDALE VALVE PROJECTS

Stage 2 – Analysis and Findings

During Stage 2, data analysis was performed and the findings were used to define project scope and to plan tasks for later stages of the project and initiated scope validation for valve enhancements.

Engineering Factors

- A PSEP Decision Tree analysis of L-235W and SL-44-654 confirmed that the project design should commence as a replacement project because L-235W and SL-44-654 scopes were less than 1,000 feet. The PSEP Decision Tree directs that scope less than 1,000 feet should be replaced because under most circumstances it is the cost effective option. In this instance there were no conditions that justified overriding this guidance.
- Based on the RER for L-235 west regulator station, SoCal Gas and SDG&E determined that:
 - The station be upsized from [REDACTED] to account for the load and velocity running through the station from SL-44-654.
 - Below ground vaults were required to mitigate noise as the regulator station is adjacent to a residential neighborhood.

During Stage 2, SoCalGas and SDG&E conducted site visits and completed scope validation for the valve projects that included detailed scope development and initial project coordination tasks to prepare for engineering, design and construction of the Palmdale Valve Project.

Scope validation determined that:

- L-235W and L-335 cross a known geological threat near Palmdale Tap Station.
- PSEP was required to install four fault isolation valves.
- The valves at the Palmdale tap required upgrades to the new ASV/RCV system.

Pipeline Safety Enhancement Plan Workpaper Supporting Chapter V

LINE 235 W, SUPPLY LINE 44-654 REPLACEMENT AND PALMDALE VALVE PROJECTS

Stage 3 – Initial Planning and Design

During Stage 3, SoCalGas and SDG&E developed a Phase 2 WOA estimate and began field surveys to complete preliminary design drawings and further refine scope.

In addition to the schedule and estimate, other key activities include identifying all permits, TRE's, and easements, defining long lead materials and pricing, understanding customer impacts and interruptions, and preparing any necessary environmental submittals.

Planning and Design Activity

Design drawings were used to define the final scope of L-235 West, SL- 44-654 and Palmdale Valve Project. The team conducted field investigations for scoping and constructability verification and initiated the ordering of long lead items. Project scope was confirmed as:

L235 West

- Replace the MLV as it was not suitable for automation.
- Replace 198 feet pipe.

SL- 44-654

- Replace 168 feet of pipe.
- Replace existing above ground regulator station with a new underground regulator station.

235-335 Palmdale Valve Projects:

- Palmdale Tap Station Valve 235-215.22-0 (see Figure 7)
 - Install new Linebreak panel with standardized PSEP ASV technology.
 - Install associated tubing, conduit, cable, utility power, and data communications.
 - Install new SCADA Pack panel equipped with remote control technology.

Pipeline Safety Enhancement Plan Workpaper Supporting Chapter V

LINE 235 W, SUPPLY LINE 44-654 REPLACEMENT AND PALMDALE VALVE PROJECTS

- Palmdale Tap Station Valve 335-37.73-0
 - Install new Linebreak panel equipped with ASV technology.
 - Install associated tubing, conduit, cable, utility power, and data communications.
- Palmdale East Station
 - Install new valve station inside a new block wall in new permanent easement of a 100 foot by 50 foot lot.
 - Valve 235-209.87-0
 - Install new 30" mainline valve with associated 12" blowdown assembly to support a class location spacing. This valve will be funded by Gas Transmission Operations.
 - Install new Linebreak panel equipped with ASV technology.
 - Install associated tubing, conduit, cable, utility power, and data communications.
 - Install new SCADA Pack panel equipped with remote control technology.
 - Install fiberglass panel shelter for electrical and control equipment.
 - Valve 335-32.36-0
 - Install new ■■■ mainline valve with associated ■■■ blowdown.
 - Install new Linebreak panel equipped with ASV technology.
 - Install associated tubing, conduit, cable, utility power, and data communications.

Palmdale West Station

- Install new valve station inside a new block wall in new permanent easement of a 75 foot by 75 foot lot.
 - Valve 235-217.85-0

Pipeline Safety Enhancement Plan Workpaper Supporting Chapter V

LINE 235 W, SUPPLY LINE 44-654 REPLACEMENT AND PALMDALE VALVE PROJECTS

- Install new ■■■ mainline valve with associated ■■■ blowdown assembly.
- Install new Linebreak panel equipped with ASV technology.
- Install associated tubing, conduit, cable, utility power, and data communications.
- Install new SCADA Pack panel equipped with remote control technology.
- Install fiberglass panel shelter for electrical and control equipment.
- Valve 335-37.73-0
 - Install new ■■■ mainline valve with associated ■■■ blowdown.
 - Install new Linebreak panel equipped with ASV technology.
 - Install associated tubing, conduit, cable, utility power, and data communications.

Additional Considerations

- Land acquisition would be required for the two new valve stations – Palmdale East and Palmdale West.
- The City of Palmdale was planning to widen Avenue S which could affect the location of the East and West Valve Stations.
- Availability of a temporary regulator station might present scheduling complications.
- Weather delays (high wind) could impact the work schedule.
- Blowdown of L-235W and L-335 would need to be coordinated with operations.
- Work hour limitations might need to be mitigated due to noise.
- Additional traffic control could be needed at Palmdale West Valve Station.

Pipeline Safety Enhancement Plan Workpaper Supporting Chapter V

LINE 235 W, SUPPLY LINE 44-654 REPLACEMENT AND PALMDALE VALVE PROJECTS

Cost Avoidance

- By refurbishing an existing [REDACTED] MLV; SoCalGas and SDG&E avoided the cost of purchasing a new valve.
- The project plan was designed to pressure test both L-235W and SL-44-654 as one test prior to tie-in using one crew since the two locations are in close proximity. This would avoid two separate days and crews to pressure test two separate lines.

Estimate of Costs

The preliminary combined estimate of the total loaded cost to complete the scope of work for the L-235W, SL-44-654 and Valve Enhancements as described below, was \$10,214,836.

The pipeline estimates were prepared in September 2013 using the Stage 3 SCG Pipeline Estimate Template Rev 0. The Palmdale Valve Project estimate was prepared in December 2013 using the Stage 3 SCG Valve Estimate Template Rev Beta. All estimates are based on preliminary design work. The following is a detailed breakdown of the estimates for L-235 West, SL-44-654 and Palmdale Valve Enhancements separately.

Table 4: L-235 W Phase 2 WOA Estimate

Cost Category	Phase 2 WOA
Company Labor Costs	\$217,602
Contract Costs	\$405,132
Material Costs	\$464,200
Other Direct Costs	\$406,194
Total Direct Costs	\$1,493,128
Total Indirect Costs	\$384,507
Total Loaded Costs	\$1,877,635

Pipeline Safety Enhancement Plan Workpaper Supporting Chapter V

LINE 235 W, SUPPLY LINE 44-654 REPLACEMENT AND PALMDALE VALVE PROJECTS

Table 5: SL-44-654 Phase 2 WOA Estimate

Cost Category	Phase 2 WOA
Company Labor Costs	\$103,878
Contract Costs	\$281,852
Material Costs	\$104,476
Other Direct Costs	\$217,998
<i>Total Direct Costs</i>	\$708,204
<i>Total Indirect Costs</i>	\$343,556
Total Loaded Costs	\$1,051,761

Table 6: Palmdale Valves Phase 2 WOA Estimate*

Cost Category	Phase 2 WOA
Company Labor Costs	\$495,690
Contract Costs	\$3,858,179
Material Costs	\$1,353,259
Other Direct Costs	\$213,559
<i>Total Direct Costs</i>	\$5,920,957
<i>Total Indirect Costs</i>	\$1,364,483
Total Loaded Costs	\$7,285,440

**This estimate includes the cost for one non-PSEP valve that is included in the scope of work and is approximately 20 percent of the Phase 2 WOA costs. These actual costs were allocated to Gas Transmission Operations.*

Pipeline Safety Enhancement Plan Workpaper Supporting Chapter V

LINE 235 W, SUPPLY LINE 44-654 REPLACEMENT AND PALMDALE VALVE PROJECTS

Stage 4 – Detailed Engineering Design and Procurement

During Stage 4, detailed design and material procurement was completed in order to provide a construction ready packet to the construction contractor to execute the planned project scope. The following scope changes occurred during this stage:

Detailed Planning and Design

The following scope changes occurred during Stage 4:

L-235W

- Add cross compression blow-off stacks to facilitate the gas blowdown.
- Add a platform to the blow-off stack for improved safety operations

SL 44-654

There were no scope changes from Stage 3 to Stage 4.

Palmdale Valve Projects

- The initial design called for chain link fencing around each site. Due to safety and security concerns, this was changed to a block wall.
- The eastern and western valve sites were designed identically; however, SoCalGas was not able to obtain the necessary footprint at the eastern station and the piping had to be redesigned to reroute conduit and piping.

Construction Contractor Selection

Both a mechanical contractor and an electrical contractor were needed to complete construction of L-235W, SL-44-654 and Palmdale Valve Projects. In order to achieve cost and schedule efficiencies, L-235W, SL-44-654 and the Palmdale Valve projects were combined into two comprehensive bid packages, one for mechanical contractor services and one for electrical contractor services. SoCalGas and SDG&E issued RFPs for lump sum bids to qualified

Pipeline Safety Enhancement Plan Workpaper Supporting Chapter V

LINE 235 W, SUPPLY LINE 44-654 REPLACEMENT AND PALMDALE VALVE PROJECTS

mechanical and electrical contractors. The contractors were provided the scope of work for all projects.

SoCalGas and SDG&E selected individual mechanical and electrical contractors from among qualified bidders. Evaluation and selection of the bids took into consideration price, schedule, work experience, and market conditions.

The Construction Contractor's bid was \$ [REDACTED] for L-235W, SL-44-654 and the Palmdale Valves which is \$ [REDACTED] more than the Stage 3 construction contractor direct estimate of \$ [REDACTED] for L-235W, SL-44-654 and the Palmdale Valves, which was used to develop the Phase 2 WOA.

Pipeline Safety Enhancement Plan Workpaper Supporting Chapter V

LINE 235 W, SUPPLY LINE 44-654 REPLACEMENT AND PALMDALE VALVE PROJECTS

Stage 5 – Construction

L-235W

Schedule

Construction Start Date: 06/09/2014

NOP Date: 09/11/2014

Construction Finish Date: 10/20/2014

Field Conditions

Conditions were encountered in the field that were not anticipated during design and planning that had to be addressed or mitigated. Listed below is a summary of the key field changes broken down by type of change:

Constructability Issues:

- To resolve an alignment issue, a [REDACTED] wedding band was installed to mitigate an the angle between the existing and new pipe.
- To reduce stress on the bridles, a pipe support was added.
- A [REDACTED] tap with a ball valve was installed on the blow-off stack. This enhancement improved safety by allowing the crews to bleed off the pressure from the [REDACTED] blow-off stack downstream of the closed blowdown valves before unbolting the blind flange.
- A platform needed to be installed to the blow-off stack for ease of access to the [REDACTED] tap with the ball valve, as well as the [REDACTED] blind flange.
- Unanticipated groundwater was found and required pumping to clear trench. The groundwater would have impeded progress and safety of the project as the crew members would have been working in knee-deep water if the water had not been pumped out regularly.

Pipeline Safety Enhancement Plan Workpaper Supporting Chapter V

LINE 235 W, SUPPLY LINE 44-654 REPLACEMENT AND PALMDALE VALVE PROJECTS

Field Conditions

Materials:

- Materials delivered after supplier promised date, thus causing a delay.

Weather:

- High winds and heavy rains caused construction delays.

Line 44-654

Schedule

Construction Start Date: 06/09/2014

NOP Date: 09/24/2014

Construction Finish Date: 10/20/2014

Field Conditions

Conditions were encountered in the field that were not anticipated during design and planning that had to be addressed or mitigated. Being that the work was in the same tap station, L-44-654 encountered similar issues to Line 235W, as listed below:

Constructability Issues:

- Unanticipated groundwater was found and required pumping to clear trench. The groundwater would have impeded progress and safety of the project as the crew members would have been working in knee-deep water if the water had not been pumped out regularly.

Materials:

- Materials delivered after supplier promised date, thus causing a delay.

Pipeline Safety Enhancement Plan Workpaper Supporting Chapter V

LINE 235 W, SUPPLY LINE 44-654 REPLACEMENT AND PALMDALE VALVE PROJECTS

Weather:

- High winds and heavy rains caused construction delays.

Palmdale Valves

Schedule

Construction Start Date: 06/09/2014

NOP Date: 09/17/2014

Construction Finish Date: 03/20/2015

Field Conditions

Conditions were encountered in the field that were not anticipated during design and planning that had to be addressed or mitigated. Listed below is a summary of the key field changes broken down by type of change for this project. Being that the work was in the same tap station, the Palmdale valve work encountered similar issues to Line 235W, as listed below:

Materials:

- Materials delivered after supplier promised date, thus causing a delay.

Weather:

- High winds and heavy rains caused construction delays.

Utility Access Issues:

- Antenna poles were installed for radio and solar equipment because it was determined after construction began that the utility power and hard-wired communications would not be accessible.

Pipeline Safety Enhancement Plan Workpaper Supporting Chapter V
LINE 235 W, SUPPLY LINE 44-654 REPLACEMENT AND PALMDALE VALVE PROJECTS

Figure 7: Assembly for L235W at Palmdale Tap: 30" MLV 235-215.22-0 shown with new actuator (in white) along with [redacted] bridle valves to and check valves to SL 44-654; [redacted] blowdown valves are also shown.



Pipeline Safety Enhancement Plan Workpaper Supporting Chapter V

LINE 235 W, SUPPLY LINE 44-654 REPLACEMENT AND PALMDALE VALVE PROJECTS

Stages 6 and 7 – Commissioning and Closeout

Commissioning activities included site restoration, final inspections and placement of the pipeline and valves back into service, transportation and disposal of the hydrotest water or hazardous materials, and demobilization from the site. During this stage, SoCalGas and SDG&E successfully performed site acceptance testing and conducted point-to-point verification with SoCalGas Gas Control for each valve that had been automated. Close out activities included development of final drawings, the reconciliation package and updates to company systems to reflect the changes made to the system.

Cost Variance

Table 7: L-235W, SL-44-654 & 235-335 Palmdale Valve Phase 2 WOA Estimate and Actual Costs

COST SUMMARY				
	COMBINED PHASE 2 WOA	PSEP PORTION OF ESTIMATE	CAPITAL (actuals)	Delta To Estimate over/(under)
COMPANY LABOR	\$ 817,170	\$ 718,032	\$ 1,160,916	\$ 442,884
CONTRACT COSTS	\$ 4,545,163	\$ 3,773,527	\$ 6,426,912	\$ 2,653,385
MATERIALS	\$ 1,922,206	\$ 1,651,500	\$ 1,606,884	\$ (44,616)
OTHER DIRECTS	\$ 837,751	\$ 795,039	\$ 2,844,620	\$ 2,049,581
INDIRECTS	\$ 2,092,546	\$ 1,819,649	\$ 1,517,305	\$ (302,344)
TOTAL LOADED	\$ 10,214,836	\$ 8,757,748	\$ 13,556,637	\$ 4,798,889

In Table 7, the Phase 2 WOA estimate includes costs for one non-PSEP valve; the non-PSEP estimate is approximately 20 percent (\$1,457,088) of the Palmdale valve Phase 2 WOA costs. An amount of (\$2,634,467) for non PSEP work was charged to the Gas Transmission Operations and is not included in the costs above. The March 2016 total loaded actual costs exceeded the PSEP portion of the Phase 2 WOA by \$4,798,889.

The above variance is attributable to scope changes and unanticipated conditions that occurred after the Phase 2 WOA estimate (including: addition of blow-off stacks; additional security installations; redesign of the eastern station to reroute conduit and piping; installation of

Pipeline Safety Enhancement Plan Workpaper Supporting Chapter V

LINE 235 W, SUPPLY LINE 44-654 REPLACEMENT AND PALMDALE VALVE PROJECTS

wedding band; additional pipe support; addition of tap and valve; discovery of groundwater required pumping to clear the trench; delayed material deliveries; weather conditions including high winds and heavy rains; and installation of antenna poles for radio and solar equipment) and an early cost estimating tool and process that was based on preliminary project designs (resulting in underestimation of construction contractor costs, engineering costs, planning and design costs, and inspection costs). These increased costs were reasonably incurred to complete the projects, but were not accounted for in the Stage 3 estimate.

Disallowances

For these replacement projects, SoCalGas and SDG&E have identified pipe as being installed post 1955 and lacking records that provide the minimum information to demonstrate compliance with industry standards or regulatory strength testing and recordkeeping requirements then applicable. Of the pipeline that was replaced, 299 feet of Phase 1A pipe are disallowed. Therefore a \$96,390 reduction was made to ratebase calculated by determining the replacement mileage and multiplying the amount by \$1.7 million per mile, which is SoCalGas' and SDG&E's system average cost of pressure testing.

Pipeline Safety Enhancement Plan Workpaper Supporting Chapter V

LINE 235 W, SUPPLY LINE 44-654 REPLACEMENT AND PALMDALE VALVE PROJECTS

Conclusion

This concludes the description of the Line 235W, 44-654, 235-335 Palmdale Valve Projects activities and \$13,556,637 of total loaded project costs incurred to design and implement safety enhancements to SoCalGas and SDG&E's high-pressure transmission pipeline system by successfully replacing 367 feet.

SoCalGas and SDG&E executed this project prudently: engaging in prudent cost avoidance efforts; minimizing customer impacts; designing and executing the project to support the Valve Enhancement Plan isolation objective (see Chapter IV (Bermel)); designing the project to use, where practicable, existing equipment; designing the project to address regulator station load and velocity; installing below-ground vaults to minimize impact (noise) to the surrounding community; designing the project to address geological threats; and responding prudently to scope changes and field conditions.

SoCalGas and SDG&E's total cost of \$13,556,637 is reasonable and should be approved (minus acknowledged disallowances). SoCalGas and SDG&E engaged in prudent cost avoidance efforts (combining three projects into one to realize costs and construction efficiencies and minimizing customer impacts; refurbishing existing equipment to avoid the cost of a new valve; and combining pressure tests to realize efficiencies and reduce costs); engaged in reasonable efforts to promote competitive and market-based rates for contractor services and materials (see Chapter II (Phillips) (approximately 98% of PSEP agreements with contractors and suppliers were either competitively bid or through agreements entered into using market-based rates based on a recent competitive sourcing event)); and used a reasonable amount of company and contractor resources given the project's complexity (coordinating multiple projects, work in populated areas, and work in a regulator station) and work scope changes (see above).

End of Line 355, 44-654 Replacement and 235-335 Palmdale Valve Project Workpaper

WP-IX-A1 - A2
Company Overheads

Southern California Gas Company

PSEP Cost Recovery Application

Overhead Costs (\$000's)

	<u>Capital (Revised)</u>	<u>O&M</u>	<u>Total</u>
Payroll Taxes	842	236	1,078
Vacation & Sick	1,323	368	1,691
Benefits (non-balanced)	1,604	440	2,044
Workers Compensation	203	62	266
Public Liability/ Property Damage	182	52	234
Incentive Compensation Plan	1,473	433	1,907
Purchasing	570	274	844
Administrative & General	1,314	-	1,314
Insurance	1,202	617	1,820
Total Overhead Costs ¹	8,714	2,483	11,198

¹ The overhead costs shown in the SoCalGas table is reflective of overheads applied to direct costs - Labor and Non-Labor. Not included in the figures are overheads applied to GMA and disallowances, totaling \$1,571K.

Total O&M of \$2,483K includes \$34K associated with the 36-9-09 North Section 2B adjustment that has been removed from this Application.

San Diego Gas & Electric Company

PSEP Cost Recovery Application

Overhead Costs (\$000's)

	<u>Capital</u>	<u>O&M</u>	<u>Total</u>
Payroll Taxes	146	0	146
Vacation & Sick	224	0	224
Benefits (non-balanced)	295	0	296
Workers Compensation	24	0	24
Public Liability/ Property Damage	45	0	45
Incentive Compensation Plan	218	1	219
Purchasing	43	3	45
Administrative & General	486	-	486
Insurance	241	2	243
Total Overhead Costs ¹	1,722	7	1,729

¹ Total overhead costs shown in the SDG&E table is reflective of overheads applied to direct costs - Labor and Non-Labor. Not included in the figures are overheads applied to GMA and disallowances, totaling \$183K.

WP-XI-A1 - A9
Revenue Requirements

Southern California Gas Company and San Diego Gas & Electric Company				
PSEP Revenue Requirements				
(M\$'s excluding FF&U)				
	SoCalGas	SDG&E	Total	
<u>O&M Costs:</u>				
Completed Projects	-53,953 53,375	685	-54,638	54,060
Descope Projects	197	-	197	
Post Completion Adjustments	382	-	382	
Regulatory Account Interest ^{1/}	-122 121	1	-123	122
<u>Capital Costs:</u>				
Completed Projects	13,695	1,938	15,633	
Post Completion Adjustments	23	-	23	
Regulatory Account Interest ^{1/}	18	3	21	
Total Revenue Requirement	-68,391 67,812	2,627	-71,018	70,439

1/ Regulatory account interests were prorated based on the costs requested in this proceeding to the total costs balanced as of March 2016.

Southern California Gas Company
PSEP Cost Recovery Application
PSEP O&M Revenue Requirements (excluding FF&U) by Project

Line	Project Name	PSEP Costs (Chapter III,V,VI) 1/	Pension/ PBOPs	Other OH Exclusions and Adjustments 2/	Post-1955 Disallowances	Adjusted O&M Revenue Requirement
		a	b	c	d	e = a-b-c-d
1	Completed Projects:					
2	1015 (North & South)	5,241,279	4,331	-	3,071,282	2,165,666
3	2000 West Sec (1,2,3)	16,403,065	16,422	-	68,470	16,318,174
4	2001 West B Sec (10,11,14)	8,472,490	(9,391)	6	-	8,481,875
5	2003 Sec (1,3,4)	2,592,067	4,644	-	-	2,587,423
6	406 Sec (1,2,2A,4,5)	3,220,138	4,445	-	-	3,215,693
7	407 (North & South)	6,430,704	13,168	65	2,789	6,414,682
8	45-120X01	857,395	-	406	-	856,990
9	PDR Storage Phase 4 and 5	5,336,370	46,635	-	3,067,096	2,222,639
10	36-9-09 North Section 2B	3,146,489	11,118	-	-	3,135,372
10	36-9-09 North Section 2B	2,566,211	9,034	-	-	2,557,177
11	36-9-09 North Section 6A	2,785,427	71	-	-	2,785,356
12	PSEP SoCalGas Lease	5,552,621	-	(216,935)	-	5,769,557
13						
14	Descope Projects:					
15	35-20-A	27,987	1,094	-	-	26,893
16	38-523	68,364	835	-	-	67,529
17	41-6045	56,231	214	-	-	56,018
18	41-80	46,473	-	-	-	46,473
19						
20	Post Completion Adjustments:					
21	Line 41-04-I	3,975	-	-	-	3,975
22	Line 2001 East	13,215	109	181	-	12,925
23	SL 38-528	2,318	74	-	-	2,244
24	Line 2000-A	282,331	3,833	(15,147)	-	293,645
25	Playa Del Rey Storage (Phases 1-3)	67,046	(930)	(1,409)	-	69,385
26						
27	Total PSEP O&M Costs	<u>60,605,986</u>	<u>96,671</u>	<u>(232,834)</u>	<u>6,209,636</u>	<u>54,532,512</u>
		<u>60,025,707</u>	<u>94,587</u>			<u>53,954,318</u>

1/ Total varies from Application due to rounding.

2/ Figures for Post Completion Adjustments include adjustments for the proration of PSEP costs in June 2014, which are included in the PSRMA Cost Recovery Application (A.14-12-016).

Southern California Gas Company
PSEP Cost Recovery Application
PSEP Adjusted Capital Cost Basis

	(a)	(b)	(c) = (a) + (b)	(d)	(e)	(f)	(g) = (c) - (d) - (e) - (f)	
Line	Project Name	Capital Costs Excluding AFUDC ¹	AFUDC ²	Total Capital Costs	Pension/ PBOPs ³	Other Exclusions ⁴	Disallowed Hydro- Testing Costs ⁵	Adjusted Capital Basis
1	Completed Projects:							
2	1005	6,345,314	131,088	6,476,402	5,339	580,563	3,910	5,886,590
3	1011	2,652,174	4,575	2,656,749	10,922	343,266	-	2,302,561
4	1013	2,729,792	8,188	2,737,981	8,491	129,932	30,770	2,568,788
5	1014	923,257	4,554	927,812	643	161,698	2,550	762,921
6	1015 (North & South)	479,566	1,425	480,991	79	234,659	7,480	238,774
7	2000 West Sec (1,2,3)	8,311,324	124,442	8,435,767	10,239	4,243,061	1,020	4,181,447
8	2001 West A Sec (15,16)	822,206	-	822,206	(26)	49,296	-	772,937
9	2001 West B Sec (10,11,14)	4,322,266	230,515	4,552,781	36,763	435,348	-	4,080,669
10	2003 Sec (1,3,4)	6,949,844	68,982	7,018,826	5,645	504,735	40,120	6,468,327
11	235 West	3,917,536	57,899	3,975,434	19,905	296,904	47,090	3,611,535
12	235 West Sawtooth Canyon	2,040,756	9,309	2,050,065	302	500,473	-	1,549,290
13	235-335 Palmdale	7,454,766	58,338	7,513,104	26,002	-	-	7,487,103
14	33-120 Section 2	7,597,820	36,350	7,634,170	12,668	113,033	-	7,508,469
15	35-20-N	279,240	5,422	284,662	2,923	28,093	17,340	236,305
16	36-1032 Sec (1,2,3)	10,893,411	59,916	10,953,327	25,805	120,970	-	10,806,552
17	36-37	1,195,044	7,232	1,202,276	12,520	103,488	2,040	1,084,228
18	38-539	16,698,784	217,020	16,915,804	6,030	160,716	-	16,749,058
19	406 Sec (1,2,2A,4,5)	7,180,491	74,822	7,255,313	7,029	905,254	-	6,343,030
20	407 (North & South)	532,647	4,064	536,711	1,654	75,428	-	459,628
21	41-30-A	483,400	325	483,725	1,300	8,952	-	473,473
22	44-654	2,035,621	32,478	2,068,099	9,995	223,536	49,300	1,785,267
23	45-120 Section 1	6,362,851	55,355	6,418,206	40,617	98,476	-	6,279,113
24	Arrow & Haven	1,110,016	47,953	1,157,969	10,330	7,387	-	1,140,251
25	Bain St	1,039,770	23,769	1,063,539	11,675	6,192	-	1,045,672
26	Brea	292,088	2,939	295,027	2,118	-	-	292,909
27	Chino Station	1,187,009	50,031	1,237,040	19,326	5,770	-	1,211,944
28	SGV Fern & Walnut	5,553,775	229,785	5,783,560	4,558	211,950	-	5,567,052
29	Haskell	782,868	22,258	805,126	4,633	7,783	-	792,710
30	Methane Pilot	356,330	1,750	358,080	573	-	-	357,507
31	Moreno - Large	587,148	29,018	616,166	6,762	307	-	609,097
32	Moreno - Small	826,524	34,576	861,101	9,209	4,255	-	847,636
33	Pixley	1,502,984	46,020	1,549,003	2,332	16,555	-	1,530,117
34	Prado	1,377,331	34,054	1,411,385	16,554	4,908	-	1,389,923
35	Puente	19,387	100	19,486	243	2,815	-	16,429
36	Santa Fe Springs	802,266	11,092	813,358	5,468	5,982	-	801,908
37	Victoria	1,696,938	37,712	1,734,650	2,793	14,977	-	1,716,881
38	Whitewater	799,378	16,612	815,990	8,405	4,081	-	803,505
39								
40	Post Completion Adjustments:							
41	42-66-1/42-66-2	16,819	-	16,819	161	658	-	15,999
42	Facilities Build-Out Costs	101,996	-	101,996	6,163	-	-	95,833
43	Line 2000-A	(167,160)	-	(167,160)	171	(1,858)	-	(165,473)
44	Total	118,093,575	1,779,969	119,873,544	356,317	9,609,644	201,620	109,705,964

NOTES:

¹ Includes capitalized property taxes of approximately \$345 thousand pursuant to SoCalGas capitalization policy.

² Capitalized Allowance for Funds Used During Construction (AFUDC) pursuant to SoCalGas' capitalization policy and based on Commission-approved formula prescribed in the FERC Code of Federal Regulations (CFR), Subchapter F, Part 201, Section 3.147.

³ Pension and PBOP overheads are calculated based on direct labor costs and are excluded from the calculation of the revenue requirements as these costs are subject to separate balancing account treatment in SoCalGas' Pension and PBOP balancing accounts.

⁴ Other Exclusions include certain non-incremental overheads such as warehousing costs and fleet; and cost of removal.

⁵ Disallowed hydro-testing costs (i.e., where pressure test records do not exist) have been excluded from the calculation of the revenue requirements.

Southern California Gas Company
PSEP Cost Recovery Application
PSEP Capital Revenue Requirements (excluding FF&U) by Project

	(a)	(b)	(c)	(d)	(e) = (b) + (c) + (d)	
Line	Project Name	Adjusted Capital Basis	Distribution RevReq	Local Transmission RevReq	Backbone Transmission RevReq	Total Revenue Requirement
1	Completed Projects:					
2	1005	5,886,590	-	-	767,349	767,349
3	1011	2,302,561	-	349,442	-	349,442
4	1013	2,568,788	-	356,966	-	356,966
5	1014	762,921	-	99,089	-	99,089
6	1015 (North & South)	238,774	7,519	24,560	-	32,079
7	2000 West Sec (1,2,3)	4,181,447	-	40,628	365,813	406,442
8	2001 West A Sec (15,16)	772,937	-	3,534	112,497	116,031
9	2001 West B Sec (10,11,14)	4,080,669	-	11,727	285,110	296,836
10	2003 Sec (1,3,4)	6,468,327	-	489,061	-	489,061
11	235 West	3,611,535	-	-	526,229	526,229
12	235 West Sawtooth Canyon	1,549,290	-	-	209,253	209,253
13	235-335 Palmdale	7,487,103	-	-	1,036,900	1,036,900
14	33-120 Section 2	7,508,469	1,349,828	-	-	1,349,828
15	35-20-N	236,305	36,807	-	-	36,807
16	36-1032 Sec (1,2,3)	10,806,552	1,285,414	-	-	1,285,414
17	36-37	1,084,228	206,872	-	-	206,872
18	38-539	16,749,058	2,018,654	-	-	2,018,654
19	406 Sec (1,2,2A,4,5)	6,343,030	-	73,589	457,563	531,152
20	407 (North & South)	459,628	-	73,124	-	73,124
21	41-30-A	473,473	79,817	-	-	79,817
22	44-654	1,785,267	257,544	-	-	257,544
23	45-120 Section 1	6,279,113	1,237,131	-	-	1,237,131
24	Arrow & Haven	1,140,251	-	10,125	147,826	157,951
25	Bain St	1,045,672	-	9,304	161,690	170,994
26	Brea	292,909	-	36,686	-	36,686
27	Chino Station	1,211,944	-	8,510	186,538	195,049
28	SGV Fern & Walnut	5,567,052	-	241,301	17,473	258,774
29	Haskell	792,710	55,853	49,070	4,032	108,954
30	Methane Pilot	357,507	-	2,266	4,783	7,049
31	Moreno - Large	609,097	-	-	84,553	84,553
32	Moreno - Small	847,636	-	3,840	106,995	110,835
33	Pixley	1,530,117	-	79,960	65,538	145,498
34	Prado	1,389,923	-	29,104	206,393	235,496
35	Puente	16,429	-	74	2,485	2,559
36	Santa Fe Springs	801,908	-	12,294	114,748	127,043
37	Victoria	1,716,881	-	47,702	104,830	152,532
38	Whitewater	803,505	-	9,223	129,862	139,085
39						
40	Post Completion Adjustments:					
41	42-66-1/42-66-2	15,999	2,749	-	-	2,749
42	Facilities Build-Out Costs	95,833	15,064	15,064	15,064	45,191
43	Line 2000-A	(165,473)	-	(2,454)	(22,133)	(24,587)
44	Total	109,705,964	6,553,251	2,073,791	5,091,390	13,718,432

NOTES:

Capital-related costs, or revenue requirements, are calculated on an aggregate basis by functional area for assets placed in service. The allocation of the capital-related costs to individual projects is based on the relative Adjusted Capital Basis of that project to the total Adjusted Capital Basis within that functional category.

Southern California Gas Company
PSEP Cost Recovery Application
Summary of Revenue Requirement (excluding FF&U)

<u>O&M Costs:</u>	Total
Completed Projects	53,953,426
Completed Projects	53,375,232
Descoped Projects	196,912
Post Completion Adjustments	382,175
Regulatory Account Interest 1/	121,989
Regulatory Account Interest ^{1/}	120,696
 <u>Capital Costs:</u>	
Completed Projects	13,695,080
Post Completion Adjustments	23,352
Regulatory Account Interest ^{1/}	18,230
Total Revenue Requirement	68,391,164
Total Revenue Requirement	67,811,676

1/ Regulatory account interests were prorated based on the costs requested in this proceeding to the total costs balanced as of March 2016.

San Diego Gas & Electric Company
PSEP Cost Recovery Application
PSEP O&M Revenue Requirements (excluding FF&U) by Project

Line	Project Name	PSEP Costs (Chapter III)	Pension/ PBOPs	Other OH exclusions	Post-1955 Disallowances	Adjusted O&M Revenue Requirement
		a	b	c	d	e = a-b-c-d
1	Completed Projects:					
2	PSEP SDG&E Lease	685,142	164	-	-	684,978
3						
4						
5						
6	Total PSEP O&M Costs	685,142	164	-	-	684,978

San Diego Gas & Electric Company
PSEP Cost Recovery Application
PSEP Adjusted Capital Cost Basis

	(a)	(b)	(c) = (a) + (b)	(d)	(e)	(f)	(g) = (c) - (d) - (e) - (f)	
	Capital Costs					Disallowed		
	Excluding		Total Capital	Pension/	Other	Hydro-Testing		
Line	Project Name	AFUDC¹	AFUDC²	Costs	PBOPs³	Exclusions⁴	Costs⁵	Adjusted Capital Basis
1	49-14	4,604,937	97,287	4,702,224	10,075	13,734	31,280	4,647,135
2	49-22	4,925,237	109,092	5,034,329	45,845	22,357	-	4,966,126
3	49-32	4,335,953	57,254	4,393,207	45,609	26,089	-	4,321,509
4	Methane Pilot	116,013	1,045	117,059	(780)	-	-	117,839
5	Total	13,982,140	264,678	14,246,818	100,749	62,180	31,280	14,052,609

NOTES:

¹ Includes capitalized property taxes of approximately \$109 thousand pursuant to SDG&E capitalization policy.

² Capitalized Allowance for Funds Used During Construction (AFUDC) pursuant to SDG&E capitalization policy and based on Commission-approved formula prescribed in the FERC Cod of Federal Regulations (CFR), Subchapter F, Part 201, Section 3.147.

³ Pension and PBOP overheads are calculated based on direct labor costs and are excluded from the calculation of the revenue requirements as these costs are subject to separate balancing account treatment in SDG&E' Pension and PBOP balancing accounts.

⁴ Other Exclusions include certain non-incremental overheads such as warehousing costs and fleet; and cost of removal.

⁵ Disallowed hydro-testing costs (i.e., where pressure test records do not exist) have been excluded from the calculation of the revenue requirements.

San Diego Gas & Electric Company
PSEP Cost Recovery Application
PSEP Capital Revenue Requirements (excluding FF&U) by Project

		(a)	(b)	(c)	(d)	(e) = (b) + (c) + (d)
Line	Project Name	Adjusted Capital	Distribution	Local	Backbone	Total Revenue
		Basis	RevReq	Transmission	Transmission	Requirement
				RevReq	RevReq	
1	49-14	4,647,135	663,184	-	-	663,184
2	49-22	4,966,126	621,861	-	-	621,861
3	49-32	4,321,509	649,321	-	-	649,321
4	Methane Pilot	117,839	-	-	3,584	3,584
5	Total	14,052,609	1,934,367	-	3,584	1,937,951

San Diego Gas & Electric Company
PSEP Cost Recovery Application
Summary of Revenue Requirement (excluding FF&U)

	Total
O&M Costs	684,978
Capital Costs	1,937,951
Regulatory Account Interests ^{1/}	4,180
Total Revenue Requirement	2,627,109

1/ Regulatory account interests were prorated based on the costs requested in this proceeding to the total costs balanced as of March 2016.